









### The first string

Members of the Northville Township Board of Trustees were sworn in for their new 4-year terms on Nov. 20. Above are (from left) Trustee Bill Selinsky, Trustee Marv Gans, Treasurer Dick Henningsen, Supervisor Karen Woodside, Clerk Sue Hillebrand, Trustee Mark Abbo and Trustee Russ Fogg. The new board held its first official meeting Nov. 21. Right, the Honorable Roman Gribbs, a township resident and friend of the new supervisor, administers the oath of office to Woodside, who later promised to lead the township into the 21st century.

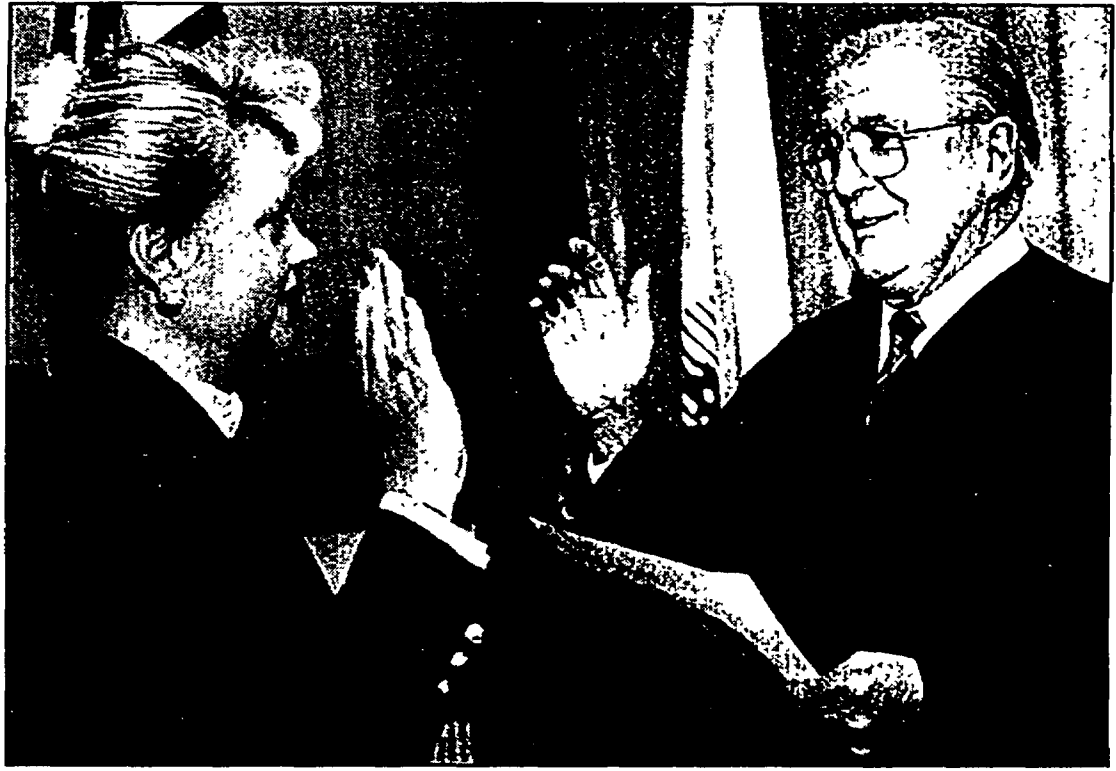

Photos by AL WARD

## Pay of electeds focus of hearing

The public will have a chance to sound off on the paychecks of state officials when the State Officers Compensation Commission holds a public hearing Tuesday, Dec. 3, in Pontiac.

SOCC will meet in the Oakland County Commissioners Auditorium, 1200 N. Telegraph, Pontiac. Invited speakers will be heard at 3 p.m. and the public at 4 p.m. (The public sound-off time was moved forward an hour since a previous announcement.)

No specific proposal for hiking salaries is before SOCC yet. Currently the governor is paid \$121,166, the lieutenant governor \$89,450, Supreme Court justices \$118,758 and legislators \$50,629.

Salaries of the Court of Appeals and trial court judges are pegged at a percentage of Supreme Court justices' salaries. The Legislature sets the salaries of the secretary of state and attorney general. University presidents' salaries are set by

the governing boards.

"Public hearings and our toll-free comment line open the process to everyone and make the commission easily accessible to the public," said SOCC chair William Hampton, a former legislator and retired Oakland circuit judge.

SOCC's recommended pay hikes will take effect unless rejected by the Legislature.

Other members besides Hampton are Yvonne Brown Blackmond of Southfield, Nancy Crandall of Norton Shores, Julia Darlow of Grosse Pointe, Mary Lukens of Ann Arbor, Russell Mawby of Augusta and Matthew McLogan of Grand Rapids.

Those who can't attend may make their views known through a toll-free number, 1-800-788-1766, or by writing to: SOCC, c/o Department of Civil Service, 400 S. Pine, PO Box 30002, Lansing 48909.

## Teens sent to slammer following traffic stop

A traffic stop for completing and improper turn and disobeying a signal netted two Northville teenagers a night in jail Nov. 19.

A Novi police officer said he stopped a car on Eight Mile Road at 9:30 p.m. and detected a strong odor of marijuana coming from the vehicle as he approached. The officer asked the four riders to produce whatever was in the car and one teen handed over a pack of

rolling papers.

Police had the teens step out of the car and the driver of the vehicle confessed to having some marijuana in the glove box.

One of the passengers admitted to owning the drug but asked "Why are you guys doing this to me?"

Police arrested two 17-year-old males and released two others at the scene.

## DNR asks help clearing Newburgh Lake of PCBs

The Michigan Department of Natural Resources is planning a fish eradication effort on Newburgh Lake beginning Thursday Dec. 5, at 4 p.m. The Lake, part of the Rouge River watershed southeast of Northville, has been contaminated for some time with carcinogenic PCBs that cannot be eliminated from the lake until those fish carrying them are removed.

Beginning Dec. 5 and continuing

24 hours a day until 4 p.m. Dec. 7, the DNR will need volunteers to help sort, count and inspect fish species that are removed from the lake.

This project will help in the future gamefish planning of Newburgh Lake and Rouge River system.

Contact John Bueter at Bueter's Outdoors in Northville at 349-3677 for more information or to volunteer.

**BRIARPOINTE  
VETERINARY CLINIC**

*Wishes your family a  
Happy Thanksgiving*

(810) 449-7447  
47330 Ten Mile • Novi  
(corner of 10 Mile & Beck)

## HIGHWAY

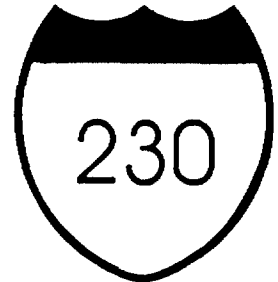

All roads lead to one or another of MDA's 230 clinics offering medical and support services to people affected by neuromuscular diseases.

**MDA**  
Muscular Dystrophy Association  
1-800-572-1717

People help MDA. Because MDA helps people.

**WORLDWIDE HARVEST CHURCH**

*A Charismatic Family Church*  
Invites YOU to join us!

Pastor Keith and Brenda McFra  
Sunday Mornings, 11:00  
The Comfort Inn - Mackinaw Room  
1-696 exit at Orchard Lk. & 12 Mile Rd.  
Farmington Hills, MI  
For More Info: (810) 926-8105

**SIXTH ANNUAL  
NOVI  
HOLIDAY ARTS &  
CRAFTS SHOW**

SPONSORED BY

**SATURDAY**  
November 30, 1996  
10 a.m. to 5 p.m.

**NOVI CIVIC CENTER**  
45175 W. TEN MILE

LUNCH AVAILABLE  
ADMISSION \$1.00  
BABY STROLLER ALLOWED

*"It's a DONE DEAL"*  
at **McDONALD**

**HOLIDAY SPIRIT SALE**

**50 NEW 1996 VEHICLES MUST BE SOLD**

**FINANCING** as low as **1.9%**  
annual percentage rate

**REBATES** up to **\$2500**  
(on select models)

Come in November 29th and  
check out our great deal on all  
new 1996 & 1997 vehicles over  
**500 available**

**GREAT DEALS ON GREAT USED CARS**

'94 TAURUS GL Auto, Air, Loaded <b>\$8,999</b>	'94 RANGER SPLASH Air, One owner 36,000 Miles <b>\$11,999</b>	'94 ESCORT SPORT Air, One owner 25,000 Miles <b>\$6,999</b>	'94 RANGER SUPER CAB 4X4 STX Auto, Air, 4.0L 29,000 Miles <b>\$15,999</b>	'94 XLT 15-PASSENGER CLUB WAGON Dual air & heat Fully loaded <b>\$14,999</b>
---	---	---	--	---

**McDONALD FORD**  
550 W. Seven Mile  
Between Northville & Sheldon Rd.  
NORTHVILLE  
(810) 349-1400 - (313) 427-6650

Mon. & Thurs. 8 am - 9 pm  
Tues. & Wed. 8 am - 6:30 pm  
Fri. 8 am - 6 pm







# WE'VE BEEN IN YOUR NEIGHBORHOOD FOR 50 YEARS. STILL FAMILY OWNED AND MICHIGAN BASED.

GIVE THE GIFT OF MUSIC! HARMONY HOUSE GIFT CERTIFICATES - AVAILABLE IN ANY AMOUNT AND REDEEMABLE AT ALL HARMONY HOUSE LOCATIONS!

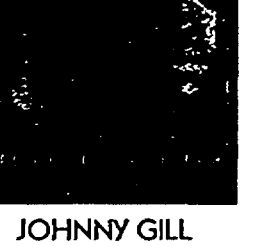

Kenny Rogers -  
Singer &  
Gambler

- |  |  |  |  |  |  |   |
|--|--|--|--|--|--|---|
| <br><b>MERRIL BAINBRIDGE</b><br>\$12.99 CD  | <br><b>THE BEATLES</b><br>\$25.99 2 CD SET                | <br><b>CLUB CUTZ (VARIOUS)</b><br>\$12.99 CD    | <br><b>PHIL COLLINS</b><br>\$12.99 CD                      | <br><b>SHERYL CROW</b><br>\$12.99 CD                  | <br><b>DANCE HITS '96 (VARIOUS)</b><br>\$13.99 CD | <br><b>CELINE DION</b><br>\$13.99 CD |
| <br><b>FENDER GUITAR 50TH ANNIVERSARY GUITAR LEGENDS (VARIOUS)</b><br>\$12.99 CD ONLY | <br><b>HOOTIE &amp; THE BLOWFISH</b><br>\$12.99 CD        | <br><b>JEWEL</b><br>\$12.99 CD                 | <br><b>ELTON JOHN</b><br>\$12.99 CD                       | <br><b>JOURNEY</b><br>\$12.99 CD                      | <br><b>DONNA LEWIS</b><br>\$12.99 CD              |   |
|  | <br><b>JOHN MELLENCAMP</b><br>\$12.99 CD                | <br><b>GEORGE MICHAEL</b><br>\$13.99 CD      | <br><b>RUSH</b><br>\$12.99 CD                           | <br><b>KENNY WAYNE SHEPHERD</b><br>\$12.99 CD       | <br><b>VAN HALEN</b><br>\$13.99 CD              |   |
|  | <br><b>DA BRAT</b><br>\$12.99 CD                        | <br><b>FLESH N BONE</b><br>\$12.99 CD        | <br><b>FOXY BROWN</b><br>\$12.99 CD                     | <br><b>LL COOL J</b><br>\$12.99 CD                  | <br><b>REDMAN</b><br>\$12.99 CD                 |   |
|  | <br><b>BEAVIS &amp; BUTT-HEAD</b><br>(SINTX) \$12.99 CD | <br><b>EVITA (SINTX)</b><br>\$22.99 2 CD SET | <br><b>THE MIRROR HAS 2 FACES</b><br>(SINTX) \$13.99 CD | <br><b>ROMEO &amp; JULIET</b><br>(SINTX) \$12.99 CD | <br><b>SPACE JAM</b><br>(SINTX) \$13.99 CD      |   |
|  | <br><b>THAT THING YOU DO!</b><br>(SINTX) \$13.99 CD     | <br><b>ANDREW LLOYD WEBBER</b><br>\$12.99 CD | <br><b>BABYFACE</b><br>\$12.99 CD                       | <br><b>BLACKSTREET</b><br>\$12.99 CD                | <br><b>TONI BRAXTON</b><br>\$12.99 CD           |   |
| <br><b>GEORGE CLINTON</b><br>\$12.99 CD   | <br><b>NATALIE COLE</b><br>\$12.99 CD                   | <br><b>JOHNNY GILL</b><br>\$12.99 CD         | <br><b>DONELL JONES</b><br>\$12.99 CD                   | <br><b>NEW EDITION</b><br>\$12.99 CD                | <br><b>TONY RICH PROJECT</b><br>\$12.99 CD      |   |
| <br><b>SMOOTH GROOVES</b><br>VOLS. 1-9<br>\$9.99 CD EACH                            | <br><b>SWV</b><br>\$12.99 CD                            | <br><b>TONI TONY TONÉ</b><br>\$12.99 CD      | <br><b>TINA TURNER</b><br>\$12.99 CD                    | <br><b>LUTHER VANDROSS</b><br>\$12.99 CD            | <br><b>112</b><br>\$12.99 CD                    |   |



Music is all we do!

DON'T FORGET TO PICK UP  
"THE BEST OF PURTAN" CD OR CS AVAILABLE  
EXCLUSIVELY AT HARMONY HOUSE!  
ALL PROCEEDS GO TO CHILDREN'S HOSPITAL  
LISTEN TO OLDIES 104.3 WOMC FOR DETAILS

SALE ENDS DECEMBER 31, 1996

PRICES SHOWN ARE SALE PRICES. IDENTICAL CASSETTE TITLES ALSO ON SALE WHERE AVAIL.

37 LOCATIONS - HARMONY HOUSE HOLIDAY HOURS: OPEN DAILY: 10 AM-9:30 PM • SUNDAYS: 11 AM-6 PM • STORE HOURS VARY  
CHRISTMAS EVE: 10 AM-5 PM • NEW YEARS EVE: 10 AM-5 PM



# Postal unions blame management for problems

By RANDY COBLE  
Staff Writer

Poor supervision and too few people are at the root of Northville's mail troubles, according to the presidents of the unions which represent local postal clerks and carriers.

Besides that, they add, conditions at the post office are giving the people who work there real problems in areas like safety, stress, morale and even health.

Postal service administrators agree that Northville's post office has problems but say they've taken the necessary steps to solve them.

An anonymous group of letter carriers who work in Northville on Nov. 12 sent a letter to the postal service's Detroit District headquarters. While the letter includes a number of complaints, two stand out. The first is that Northville

needs more people to deliver the mail effectively. The second is that the supervisors responsible for managing the office aren't doing their jobs.

The heads of the two unions agree.

"Northville is notorious for improper management," said Roger Holbrook, local area president of the American Postal Workers Union. The organization represents clerks and maintenance workers in Northville.

Holbrook said that Northville Postmaster Judy Buffmyer, placed on "administrative leave" by Detroit postal officials, has not laid down the law to the supervisors under her who, according to the letter, have been behaving inappropriately.

"She needed to kick the butts of her supervisors out there a long time ago," Holbrook said. "She

hasn't always done what she needed to do and that's kind of developed a total lack of respect for everything in general. If you don't have a captain of your boat you're going to go around in circles."

The letter uses words like "favoritism," "intimidation" and "reprisal" to describe the behavior of some supervisors in Northville. It says that some workers are cut slack, making it harder on everyone else, while people who complain are sometimes the targets of harassment. Several specific incidents are cited.

Holbrook and Tim Manning, president of Branch 2184 of the National Association of Letter Carriers, also say that postal service officials aren't giving the Northville post office the people it needs to make sure the mail gets delivered right and by a workforce that's not running itself ragged.

"There is a bad mix between the number of workers out there and the amount of work. It's the worst workload I've ever seen," said Manning, who represents 38 Northville carriers.

While Northville gets hundreds of new homes to deliver to every year, the workforce has not kept pace. The result, according to Manning, is that many at the post office work as much as 60 hours a week, week in and week out, leaving almost no time for family or outside interests.

Holbrook said the situation is so bad that workers often can't get days off for vacation or even doctor appointments. It all has a marked impact on the workers' morale, stress level and physical health, he added.

"These folks really care about that mail and about doing their jobs right. That's why it's so frus-

trating to see this," Holbrook said.

Earl Flowers, the manager of post office operations for the Detroit District, said postal service administrators are taking steps to examine the situation at Northville and correct any problems.

He said complaints about supervisors like the ones in the letter are often heard in the postal service but "then no one is able to substantiate anything." He added, however, that the postal service feels things have to change in Northville.

"We need to provide proper direction to the supervisors there now," Flowers said. "We don't feel like proper guidance was provided here."

Regarding the high amount of mandatory overtime Northville post office workers are putting in, Flowers said that staffing levels will be reviewed to see if more peo-

ple are needed.

"The post office nationwide is seeing a lot of apprehension among employees these days. Flowers said, because of the postal service's introduction of automation to speed mail sorting and delivery efficiency.

The idea is that as workers are displaced from a post office that doesn't need as many people due to automation, they'll then be sent to offices with heavy workloads, such as Northville.

"I think it's human nature to have a fear there. Our challenge is to make them see that this isn't a problem," Flowers said.

While the changeover takes place, a process that will likely take years, the postal service is looking at hiring "non-career" transition-phase employees to help out where they're needed, such as in Northville.

## District steps in to address difficulties

Continued from 1

tion ballot.

Double-timing those items out the door was the first thing postal headquarters people called for when they arrived last week. That's why some homes in Northville received two and even three mail deliveries on Nov. 21 and 22.

Coming next, postal officials say, are things like performance reviews of local supervisors and taking another look at staffing levels to see if Northville needs more people to move the mail appropriately.

To upset postal customers' it all means an end to their troubles, according to Earl Flowers, manager of post office operations for the Detroit District.

"We found out there was a problem and we've worked to correct it," Flowers said Friday. "We certainly apologize to everyone who's experienced difficulty but it's fixed as of today and won't be happening again."

Maybe not, say union representatives for the clerks and carriers who work at the Northville office. But they want to see more done (see related story).

Workers at the post office have declined to discuss the situation publicly but privately say things have been off-kilter for months. It all came to a head, however, when an anonymous group of carriers sent a letter of complaint on Nov. 12 to the postal service's Detroit District headquarters.

The letter alleges a number of problems with mail operations in Northville, most of them stemming from two things: too few people for too much work and poor management by postal supervisors.

Northville's top supervisor, Postmaster Judy Buffmyer, was placed on indefinite "administrative leave" in the wake of the letter.

Flowers said no decision has been made yet about her status or if Buffmyer will return to her position.

Underlining the seriousness of the situation was Friday morning's visit to the post office by Carl January, postal manager of the entire Detroit District. He was unavailable for comment.

Taking over day-to-day operations at Northville is Officer-in-Charge Tony Hubbard, brought in from Ypsilanti for an undetermined amount of time.

Several area post offices dispatched workers to Northville last week to clear out the undelivered mail.

## U.S. mail delivery agency is independent entity

By RANDY COBLE  
Staff Writer

Here are some fast facts about America's mail delivery system:

- The United States Postal Service (USPS) is the world's largest mail delivery organization. It handles more than 170 billion pieces of mail a year, 40 percent of the planet's total. The USPS includes about 750,000 people and is second only to the U.S. military as the largest employer in the nation.
- The Constitution says that the federal government will be respon-

sible for the postal system. From 1789 until 1971 that job was the purview of the Department of the Post Office.

- In 1971 Congress replaced the Department of the Post Office with the USPS. It's a government agency but unlike most others is run largely independently of the government. Since 1983 the USPS has received no taxpayer dollars. The system instead operates with money gained from user fees like the 32-cent first class stamp.
- Financial difficulties have led

the USPS to hike fees several times. In 1974, for example, a first-class stamp cost eight cents. Today it costs 32 cents.

- By law only the USPS can handle first-class mail but private firms are allowed to handle the rest: two examples are UPS and Federal Express. There are five classes for mail: express and first through fourth class, each with its own postage rate.
- Our first public postal system was created even before the country was, in the year 1639 in the

Massachusetts Bay Colony. In 1775, after war had broken out with Great Britain, the first Continental Congress named Ben Franklin the first postmaster.

- One of the most colorful chapters in postal history came in 1860-61 with the Pony Express. Riders took mail over the 2,000 miles separating St. Joseph, Mo., and Sacramento, Calif., in about 10 days. The transcontinental telegraph, however, put the Pony Express out of business just a year and a half after it began.

### Winter Walden Ski & Snowboarding Club for Children



- \* Professional instructions
- \* Classes for all skill levels - beginner to expert
- \* Special program for the younger skiers (ages 7-8)
- \* Small classes
- \* Adult classes too!
- \* Charter buses Saturday & Sunday

**WUW** 810 855-1075  
ski club  
Celebrating our 22nd Season!

Teaching Kids to Ski is Our Business

# SKIING

### NOTICE OF PUBLIC HEARING NORTHVILLE TOWNSHIP DEVELOPMENT PROJECT PLAN

NOTICE IS HEREBY GIVEN that the Wayne County Commission will hold a hearing on Thursday, December 5, 1996, beginning at 10:00 o'clock a.m., at the Wayne County Building, 4th Floor, 600 Randolph St., Detroit, MI 48226.

The hearing shall consider whether the Project Plan recommended to the Wayne County Commission by the Economic Development Corporation of the Charter County of Wayne, (the "EDC") for the Northville Township Development Project (the "Project") constitutes a public purpose as outlined by Act No. 338 of the Michigan Public Acts of 1974, as amended.

The project will be comprised of 1) the EDC acquiring land from the County and preparing it for sale, 2) the EDC selling the land pursuant to the Project Plan via a Purchase and Operating Agreement between the County and the EDC, 3) a Planned Unit Development (PUD) Agreement with the Township of Northville, and 4) the monitoring of the PUD Agreement until all property is sold.

The Project will be located on County-owned surplus property in Northville Township. The project area includes Section 16 of Northville Twp. with the exception of 30 acres owned by Optical Imaging Systems, Inc. Section 16 is bounded by Beck Road on the west, Five Mile Road on the south, Six Mile Road on the north and the section line on the east. The Project area also includes the southwest and southeast quarters of Section 15, with the exception of 14.5 (+) acres of property of the northeast corner of Sheldon and Five Mile Roads owned by the State of Michigan. Section 15 is bounded by Six Mile Road on the north, the section line on the west, Edward Hines Dr. on the east, and Five mile on the south and includes 11 (+) acres of property located at the southwest corner of Five Mile and Northville Rd. within Section 15.

Maps, plats, a copy of the Project Plan and all other information related to the Project are available for public inspection at the Commission Clerk's Office (313-224-0903), 406 Wayne County Building, and at the Business Development Division, 323 Wayne County Building, 600 Randolph St., Detroit, MI, between the hours of 8:30 a.m. and 5:00 p.m., weekdays. Any aspect of the planned Project may be discussed at the Public Hearing, all interested persons will be given an opportunity to be heard and the Wayne County Commission will receive and consider communication in writing with reference to this hearing.

Published, Posted and Mailed to property owners of record within the Project District Area.

**ALFRED N. MONTGOMERY**  
Clerk of the Commission

308-11730



Now,  
it's for everyone!

Ameritech  
Pick Up & Go  
Cellular.

It's a whole new way to give cellular.  
No contracts. No credit checks.  
No monthly bills!

For the first time ever, you can give the gift of Ameritech® cellular to everyone on your list. Only from Ameritech, Pick Up & Go Cellular comes with 30 minutes of local paid airtime built in. So if they want more, they can add more.

If they don't, they don't. No obligations. Just pure peace of mind. Now that's a thoughtful gift. Why not treat yourself, too?

**GREAT STOCKING STUFFER!**  
The NEC pager now only \$49  
with 3 months free service.  
Paging contract required.

**Ameritech**  
YOUR LINK TO BETTER COMMUNICATION®

Restrictions, terms and conditions apply. Call 1-800-MOBILE-1 for details. J.D. Power and Associates Cellular Satisfaction Study based on 3,445 cellular telephone subscribers in 8 of top 15 markets. Detail market includes: Lapeer, Livingston, Macomb, Oakland, St. Clair, Washtenaw and Wayne in the state of Michigan. Pages shown and service may not be available in all areas. See dealer for details. Paper offer ends 12/31/96. Offer available at participating locations. © 1996 Ameritech

**SECOND YEAR IN A ROW**  
**HIGHEST OVERALL CUSTOMER SATISFACTION AMONG CELLULAR USERS**

AVAILABLE ONLY AT YOUR AMERITECH DEALERS

<ul style="list-style-type: none"> <li>•AMERITECH CELLULAR CENTERS</li> <li>Ann Arbor (313) 669-8079</li> <li>Bloomfield Hills (810) 338-1573</li> <li>Brighton (810) 220-8235</li> <li>Dearborn (313) 577-4111 (313) 377-0134</li> <li>Eastpointe (810) 777-0007</li> <li>Farmington Hills (810) 489-8530</li> <li>Flint (810) 733-6061</li> <li>Horshornown (313) 258-6007</li> <li>Lakeside (810) 666-8050</li> <li>Lathrup Village (810) 557-8855</li> <li>Novi (810) 440-1779</li> <li>Plymouth (313) 451-0720</li> <li>Port Huron (810) 385-6089</li> <li>Rochester (810) 608-9750</li> <li>Royal Oak (810) 849-7900</li> <li>Southgate (313) 285-8066</li> <li>Troy (810) 588-6780</li> <li>Warren (810) 568-6452</li> <li>Westland (313) 427-6700</li> <li>•ABC WAREHOUSE</li> <li>16 Locations to Serve You</li> <li>ADVANCED COMMUNICATIONS</li> <li>Detroit</li> <li>Lathrup Village (810) 562-8700</li> <li>AIR AMERICA</li> <li>Royal Oak (810) 280-2222</li> <li>Novi</li> <li>Oak Park (810) 547-7777</li> <li>•ALL TIME AUDIO</li> <li>Fairhaven</li> <li>Rochester</li> <li>St. Clair (810) 725-6854</li> <li>•AUTO ADD ON</li> <li>Plymouth</li> <li>Southgate</li> <li>Woodhaven (313) 451-1500</li> <li>•AUTO ALARM AUTHORITY</li> <li>Redford, Dearborn</li> <li>Dowdenville, Warren</li> <li>S.W. Detroit</li> <li>(313) 282-6200</li> <li>•AUTO AMERISTAR CELLULAR &amp; GLASS CENTERS</li> <li>Farmington Hills</li> <li>Lincoln Park, Southgate</li> <li>Taylor, Troy</li> <li>Walled Lake, Warren</li> <li>1-800-217-STAR</li> <li>BEEPER EXPRESS</li> <li>Nine locations to serve you!</li> <li>(810) 388-0191</li> <li>CHAMPION COMMUNICATIONS</li> <li>Clinton Township</li> <li>Shelby Township</li> <li>Sterling Heights, Troy (810) 268-7755</li> <li>•CYBER-NET TECHNOLOGIES</li> <li>Dearborn (810) 781-9330</li> <li>•DISCOUNT VIDEO</li> <li>Lake Orion (810) 893-4543</li> <li>EXPRESS PAGING</li> <li>Taylor (313) 236-4000</li> <li>FINISHING TOUCHES MOTORING</li> <li>Birmingham (810) 645-2236</li> </ul>	<ul style="list-style-type: none"> <li>GENERAL CELLULAR SALES</li> <li>Troy (810) 524-3232</li> <li>•HAWTHORNE HOME ELECTRONICS AND APPLIANCE</li> <li>Birmingham, Rochester</li> <li>•HENDERSON GLASS</li> <li>30 Locations to Serve You</li> <li>Including: Ann Arbor, Fraser, Novi, Shelby Twp., Southfield</li> <li>1-800-507-7350</li> <li>JEROME DUNCAN FORD</li> <li>Sterling Heights (810) 977-6280</li> <li>MEGABYTE COMPUTERS</li> <li>Warren (810) 756-0000</li> <li>METROCELL</li> <li>Allen Park</li> <li>Auburn Hills, Burt</li> <li>Detroit</li> <li>Farmington Hills</li> <li>Flint</li> <li>Grosse Pointe</li> <li>Mt. Clemens</li> <li>Novi, Port Huron</li> <li>Sterling Heights</li> <li>Ulster, Warrendale</li> <li>1-800-LEADER 1</li> <li>METRO 25</li> <li>1-800-METRO-25</li> <li>MIDWEST AUTOTEL</li> <li>W. Bloomfield (810) 960-3737</li> <li>•MIDWEST ELECTRONICS</li> <li>Call for the location nearest you</li> <li>1-888-4-MIDWEST</li> <li>PAGE COM</li> <li>Dearborn (313) 582-0940</li> <li>PAGEONE</li> <li>Clinton Twp. (810) 750-0000</li> <li>ADVANCED COMMUNICATIONS</li> <li>Detroit</li> <li>Ann Arbor, Canton</li> <li>Flint, Garden City</li> <li>Inkster</li> <li>Metromobile, Westland (313) 421-8000</li> <li>PAGE TEL</li> <li>Call for nearest location</li> <li>1-888-217-2141</li> <li>PAGING PLUS</li> <li>Flint, Oak Park (313) 968-7244</li> <li>PAGING PLUS II</li> <li>Imperial (313) 858-6110</li> <li>PALCO ELECTRONICS</li> <li>Southgate/Downtown (810) 284-1913</li> <li>PREMIER CELLULAR</li> <li>Livonia (810) 442-7400</li> <li>QUICK PAGE, INC.</li> <li>Mason Heights, Warren (810) 411-8888</li> <li>•RADIO, KNOSBS, SPEAKERS &amp; THINGS</li> <li>Porter</li> <li>Keweenaw</li> <li>(810) 858-8451</li> <li>RAPID PAGE, INC.</li> <li>Hazel Park (810) 542-3333</li> <li>SKYNET COMMUNICATIONS</li> <li>Clinton Township &amp; New Baltimore</li> <li>1-800-SKYNET 9</li> <li>•SOUND SECURITY, INC.</li> <li>Warren, St. Clair Shores (810) 776-7000</li> <li>STAR 1 COMMUNICATIONS</li> <li>Dearborn Heights, Mt. Clemens</li> <li>Taylor</li> <li>1-800-OK-STAR 1</li> <li>•TRA GROUP</li> <li>Auburn Hills (810) 377-0400</li> <li>•U.S. WIRELESS</li> <li>Clinton Township (810) 263-6700</li> <li>WOW! COMMUNICATIONS</li> <li>Essieco, Troy</li> <li>Mt. Clemens</li> <li>Gibraltar North</li> <li>St. Clair Shores, Grosse Pointe</li> <li>1-800-YOUR CALL</li> </ul>
---	---

\*Ameritech Paging available only at these locations.  
Offer available at participating locations.

**Call 1-800-MOBILE-1**

# After Thanksgiving 2 DAY SALE

Extended Hours:

SHOP FRIDAY,  
NOV. 29, 7am-11pm;  
SATURDAY, NOV. 30,  
8am-11pm

## EARLY BIRD SPECIALS

Friday Only 7am-11am

## 40 BONUS BUYS Friday Only

Mickey's  
Magic  
Christmas!

This Mickey Mouse holiday plush toy—available exclusively at Kohl's—is just \$12.99 with any \$30 purchase. While supplies last. Reg. \$25.99

©DISNEY



### JUST A FEW OF OUR EARLY BIRD SPECIALS:

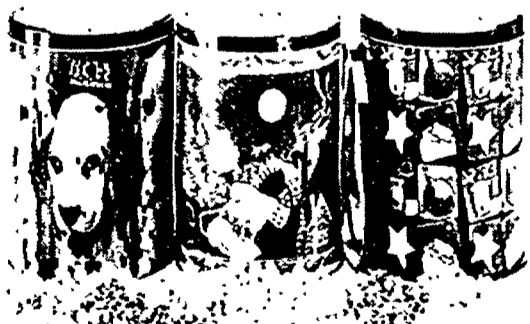

**3.77** ea. 3½-gallon 3-way popcorn tins. 18 designs exclusive to Kohl's. Reg. 9.99 ea. Limit 10 tins per customer

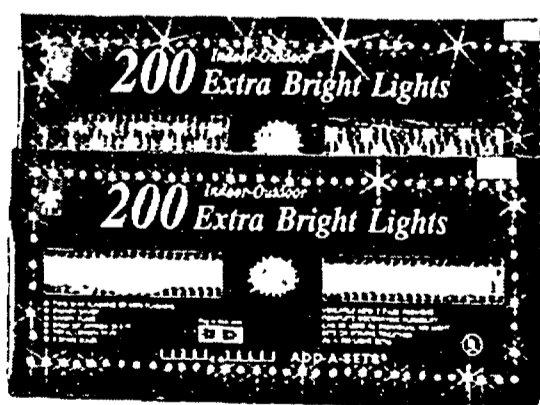

**3.99** ea. 200-ct. Add-a-Set lights. Choose from clear or multi-colored. Reg. 9.99

REGAL



**59.99** 50% off a 1½-lb breadmaker. Six menu selections including rice & jam. Ideal for gluten-free breads. Reg. 129.99

PLUS TAKE AN  
EXTRA 10% OFF

**60% Off** Entire stock 14k gold charms & bracelets. Reg. \$50-\$800, sale \$20-\$320; less 10%, FINAL PRICE \$18-\$288

# KOHL'S

*That's more like it.*

# Senior residents nestle in at Wynwood living center

By RANDY COBLE  
Staff Writer

Judging from the way they've taken to life at Wynwood House, the folks who live in the community's new senior citizen assisted living center, are walking in tall cotton nowadays.

"I love it. I wanted something in Northville, something close to my home. Now this is my home," was how Harriet Welland put it over a lunch of barbecued chicken, potato salad and fresh broccoli in one of Wynwood's "neighborhood" dining rooms recently.

If her name sounds familiar, it should; Welland is a longtime Northville resident who's been active in everything from the Woman's Club to the Historical Society. She and her husband Bob, in fact, provided the furnishings for Mill Race Village's Wash Oak School.

An Ely Street resident for many years, Harriet decided this year to give Wynwood House a try after Bob passed away. She was the very first person to sign up.

Located on Six Mile just west of Sheldon Road, Wynwood puts Welland still just a hop, skip and a jump away from her kids and grandkids. She visits almost daily with her daughter who lives in King's Mill and all of the familiar sights and sounds of Northville are

"It really makes a difference when you can be in the vicinity of your friends and family."

-Harriet Welland  
Wynwood House resident

still there as well.

"It really makes a difference when you can be in the vicinity of your friends and family," she said.

Statistics show, in fact, that most people who live in assisted living centers like Wynwood House either come from or have family members within a seven mile radius, according to Director Esther Strohmer.

Besides being close, Wynwood House offers the lifestyle Welland says she's looking for. Licensed for up to 72 residents, the place offers assisted living services that include everything from meals prepared and served to help with medications and those day-to-day tasks that are sometimes difficult for older folks.

Many social and recreational activities are also available to residents of the Northville Township living center.

Though she and all the other residents have been at Wynwood House barely a month, Welland, 76, is already getting involved in things again.

The former administrator of the

allied health division at Henry Ford Community College, she's now president of Wynwood's resident council. Harriet already uses a warm and familiar "we" when she talks about her new home.

"We're a family," was how she put it.

That's the idea behind Wynwood, Strohmer explained. It's supposed to be more than just a glorified hotel.

"We try to give everything a very homey feel," she said.

Outside, patio chairs and a day-enport line the porch. Inside, the building is a collection of individual "neighborhoods" for up to 16 people, each including features like its own dining room and lounge.

There's also a beauty shop and library, and religious services are offered on Sundays. Everyone has a private or semi-private room with bath facilities, which they can decorate with their own furniture and mementos.

On Martha Dewhirst's wall, for example, there is a framed note of congratulations from President



Photo by AL WARD

Harriet Welland does a lot of work at her organizing desk in her living quarters.

Jimmy Carter on the occasion of her 60th wedding anniversary in 1979. Harriet's neighbor, Martha, is 97 and still going strong.

Her electric organ now sits in Wynwood's tea room but Martha doesn't get much time to play it. She reportedly spends a lot of hours as a cardsharp, beating all comers from among the residents and staff alike.

"Oh, don't embarrass me," was all she would say, albeit with a smile, when asked about it.

Harriet, meanwhile, has a painting of the Missouri farmhouse where she was born in her room. Nearby stands her desk, the "optimist on duty" sign prominently displayed. It's there that she works with Strohmer and Life Enrichment Coordinator Amy Schuster

on a range of activities to offer to Wynwood residents.

The doings include everything from daily things like exercise and bowling to special events like a party for family members and an outing to see the holiday colors at Domino's Farms.

If you're interested in more information or a tour of Wynwood House call Strohmer at 420-6104.

## 1996 SPA CLOSEOUT

Serious Savings on all '96 Spas. Choose from 30 in stock

**SAVE \$1000**

**\$6499**

Reg. 7499

**SAVE \$1000**

**\$6499**

Reg. 7499

**Coleman Spas**

Now you can relax

**FREE**

- Ozone • Cover Butler
- Steps • Delivery

with purchase of Coleman Spa (excluding Journey)

**OR 180 Days Same As Cash.**

With Approved Credit Previous Sales Excluded

**SAVE \$1000**

**\$5299**

Reg. 6299

**BERKLEY**  
2750 W. 12 Mile Rd.  
398-4577

**SAVE \$450**

**\$2499**

Reg. 2949

**UTICA**  
48370 Van Dyke Highway  
739-5333

**POOLS**

SINCE 1965

POOLS & CO. CO  
Family Owned & Operated

Mon., Tues., Thurs., Fri.  
11-7  
Sat. 11-4

**GRAND OPENING**

## DOLL & BEAR HUGS

**FRI. NOV. 29th**

- ♥ DOLLS & BEARS
- ♥ MANY UNIQUE "ONE OF A KIND" GIFT ITEMS

- ♥ HAND CRAFTED COUNTY FURNITURE (Custom Order)
- ♥ YEAR-ROUND CHRISTMAS ROOM

**ENTER FREE DRAWING**

**10% OFF PURCHASE WITH AD • EXP. 12-8-96**

collectibles & sundries  
494 N. Mill

Hours  
Sun. Tues. Wed 12-5  
Thurs 12-6 • Fri 12-7  
Sat 11-6

(313) 207-0655 • Located in Plymouth's Historic Old Village

# SPRING Newspapers

## have your winning number in suburban Detroit.

7 6 1 8 8 5

SPRING's audited circulation is a sure bet.

It's no gamble. Buying SPRING Newspapers in suburban Detroit is a sure bet. Why risk your newspaper media dollars on an un-audited circulation? When you buy SPRING Newspapers, you're buying the largest audited circulation in suburban Detroit. The Detroit News and the Free Press have yet to issue a current ABC audit, so there's no telling how many papers are being printed - and who's receiving them. SPRING Newspapers are not only a sure bet, they're also a smart bet. For example:

- 48% of adults in the SPRING survey area read SPRING weekly and daily newspapers.
- SPRING has an audited circulation of 761,885.

- SPRING delivers, on average, 1,060,000 total readers every week.\*
- That means that SPRING delivers 1,167,000 gross impressions for an entire week.

Compare these numbers to your other media alternatives: only 37% of adults in the SPRING market read the weekday Detroit Free Press or The Detroit News!

owners (31%) than any other weekday newspaper.

To find out more about the Detroit market and for more information about our current audit, call the SPRING Newspaper Network at 1-800-382-8878.

**SPRING**  
Newspaper Network

Detroit Suburban Press Ring

REACH PEOPLE WHERE THEY LIVE.

More suburban Detroit readers turn to SPRING.

- SPRING delivers more weekday suburban readers with household incomes over \$50,000.
- SPRING delivers more suburban home-

\*Readership is net weekly plus net Sunday

† Source: 1996 Belden Associates survey of SPRING markets in Macomb, Livingston, Oakland and Wayne counties

The Observer & Eccentric Newspapers/Heritage Newspapers/Independent Newspapers/Michigan Community Newspapers/Hometown Newspapers™

1-800-382-8878

## CLASSIC INTERIORS FURNITURE

The Holidays Are A Time Of Giving  
and OUR GIFT TO YOU IS

# 40% OFF

EVERYTHING IN THE STORE FOR FOUR DAYS ONLY!

FRI. 11/29 • SAT. 11/30 • SUN. 12/1 • MON. 12/2

And, AS AN EXTRA GIFT TO YOU, MAKE YOUR PURCHASE \$2500 OR MORE and Classic Interiors WILL PAY YOUR 6% SALES TAX!

Mon., Thurs., Fri. 9:30-9:00/ Tues., Wed., Sat. 9:30-5:30; Open Sun. 1-5

## CLASSIC INTERIORS FURNITURE

20292 Middlebelt, Livonia • South of 8 Mile • (810) 474-6900

- All discounts Are Off Manufacturers Suggested Retail Prices
- All previous sales excluded • Offer not valid in conjunction with any other promotional discount

VISIT OUR IN STORE CLEARANCE ENTER

Call GREEN SHEET CLASSIFIED (810) 348-3022

**Obituaries**

**DAVID O. O'CONNELL**  
David Owen O'Connell of Northville died Nov. 21, 1996, in St. Mary Hospital, Livonia. He was 70.  
Mr. O'Connell was born Jan. 9, 1926, in Detroit, Mich.  
Mr. O'Connell had been a manufacturer's representative with D&C Plumbing in Walled Lake. Prior to working at D&C, he was in sales with his father and brothers at O'Connell Supply Co., Dearborn, and later, as a manufacturing representative with R.E. Wallace.  
His memberships included the Knights of Equity, the Knights of Columbus, and the past presidency of St. Gabriel's and Precious Blood dad's clubs. He enjoyed competition in sports.  
In the early 1990s, he was a senior Olympics medalist in the javelin, long jump and discus events. According to his family, his famous boast was, "I'll beat you in any 15 sports, you name 'em."  
Mr. O'Connell had been married to his wife Mary (Keating) for 38 years when she preceded him in death in 1986.  
He is survived by his sons Patrick (Catherine), Timothy (Margaret), Dennis (Patricia), Thomas, and Joseph (Deborah); daughters Noreen (Donald) Weston, Anne (Allan) Frank, and Kathryn; brother Francis Jr.; sisters Eileen McMahon, Beulah Stewart, Rosemary Hogan, and Sister Noreen

O.P.; and eight grandchildren.  
Services were held on Monday, Nov. 25, at St. Colette Church in Livonia.  
Arrangements were made by O'Brien/Sullivan Funeral Home, Novi.  
Memorials to the charity of your choice would be appreciated by the family.

**KATHRYN L. WIDMAN**

Kathryn L. Widman died Nov. 23, 1996, in the University of Michigan Medical Center, Ann Arbor, Mich. Ms. Widman was 81. She was born March 5, 1915, in New Albany, Ind., to Edward and Lena (Hurrie) Widman.  
Ms. Widman was a graduate of Detroit Central High School and the Detroit Business University. She was an executive secretary with AAA of Michigan for 47 years. From 1968 until her retirement in 1981, Ms. Widman was an executive secretary to Richard Dann, president of AAA of Michigan.  
After retirement, she moved from Detroit to Northville.  
Her memberships included the First Presbyterian Church of Northville, Friends of the Northville Library, Northville Historical Society, Professional Secretaries International, and the Zoar Society.  
She is survived by her brother, Richard G. (Barbara) of Naples, Fla.; sister-in-law Loraine Wid-

man; nephew Richard T. (Dale) Widman of Charleston, S.C.; nieces Linda K. (Douglas) Weyer of Sagamore Hills, Ohio, and Jeanne (Rod) Overby of Lake Worth, Fla.; and eight grandnieces.  
Ms. Widman was preceded in death by her brother, Lee Widman.  
Visitation for Ms. Widman will be on Friday, Nov. 29, in the Northrop-Sassaman Funeral Home, 19091 Northville Road, from 2 to 5 p.m. and 7 to 9 p.m. Memorial services will be Saturday, Nov. 30, at 11:30 a.m. in the First Presbyterian Church of Northville, 200 E. Main St. The Rev. W. Kent Clise and Rev. James P. Russell will officiate. Burial will be in Acacia Park Cemetery in Southfield Township, Mich.  
Memorial contributions will be accepted by the First Presbyterian Church of Northville in memory of Ms. Widman.

**GOLDENA M. LIBBY**

Goldena Mary Libby died Nov. 25, 1996, in Star Manor of Northville. She was 94. Mrs. Libby was born on Sept. 3, 1902, in Ontario, Canada, to Louis and Annie (Bondy) Deslippe.  
Mrs. Libby was a homemaker and a resident of Northville since 1970.  
She is survived by her sons, Gordon (Patricia) of Garden City and Paul (Margaret) of Highland;

daughters June Mary (Robert) Tucker and Nora Miller of Northville, and Dorothy A. (Donald) Spain of Adrian; brothers Bernard and Roy Deslippe of Canada; sisters Lillian Braunstein of Ft. Lauderdale, Fla., Geraldine Deslippe and Gertrude Anderson of Canada; 22 grandchildren, 45 great grandchildren, and five great great grandchildren.  
Mrs. Libby was preceded in death by her husband, Gordon, in 1984, and a son Orley.  
A Mass will be said at 11 a.m. Friday, Nov. 29, in Our Lady of Victory Catholic Church. Father Todd Laginess will officiate. Interment will be in Rural Hill Cemetery.  
Arrangements were made by Northrop-Sassaman Funeral Home of Northville.

She is survived by her daughter Lila (Duane) Taft of Charlotte; brother Karry (Virena) of South Lyon and sister-in-law Theda Lyke, also of South Lyon; three grandchildren, Sherry (Phil) Warwick, Richard L. (Melanie) Miller, and David P. (Kim) Miller; and 13 great grandchildren.  
Mrs. Rakestraw was preceded in death by her husband, Lyle, and her brother, Russell.  
Visitation will be held on Tuesday, Dec. 3, from 2 to 8 p.m. at Casterline Funeral Home in Northville. Services will be conducted at Casterline Funeral Home on Wednesday, Dec. 4, at 11 a.m. Pastor Lance Rubinger of Salem Bible Church in Salem will officiate. Interment will be in Thayer Cemetery, Northville Township.

**ARTHUR M. AYERS**

Arthur Monroe Ayers of Milford died Nov. 18, 1996, in Providence Hospital, Southfield. He was 79. Mr. Ayers was born Nov. 20, 1916, in West Virginia, to Martin and Anna (Melvin) Ayers.  
Mr. Ayers moved from Wellston, Ohio, to Milford in 1971. He was a member of the Masonic lodge.  
His survivors include his wife Margaret (Gregory); son Charles of Northville; sisters Mary Lou Eanes of Florida and Emma Jean Potts of Wellston, Ohio; brothers Lester, Wayne, and Robert, all of Colum-

bus, Ohio; two grandchildren and two great grandchildren.  
Arrangements were made by Casterline Funeral Home of Northville.  
Services were conducted on Nov. 22 at Rogers Funeral Home in Wellston, Ohio. Interment was at Ridgewood Cemetery, Wellston.

**GLEN R. ANGELL**

Glen R. Angell of Northville died Nov. 16, 1996, at his residence. He was 79. Mr. Angell was born in Northville on June 4, 1917, to Glen S. and Martha (Richards) Angell.  
Mr. Angell was a lifelong member of the community. He retired from General Motors Corp. and was a member of the Plymouth United Assembly of God and V.F.W. Post No. 4012, Northville.  
He is survived by his daughters Renee Juco of Northville and Linda Bedwell of South Lyon; six grandchildren and three great grandchildren.  
Mr. Angell was preceded in death by his wife, Ruth A., in 1981.  
Services were held on Wednesday, Nov. 20, at Casterline Funeral Home with Pastor Kenneth Hubbard, Plymouth United Assembly of God, officiating. Interment was in Rural Hill Cemetery, Northville.  
The family would appreciate memorials to the 700 Club.

**The Northville Record**

**SAVE 30%**

Subscribe now for only **\$18<sup>00</sup>\***

What a great deal! Rush me one year (52 issues) of The NORTHVILLE RECORD for only \$18.00. I save 30% off the street sale price of \$26.00.  
\*Offer good for new subscribers only.  
\*Offer good until May 31, 1997

Name \_\_\_\_\_  
Address \_\_\_\_\_  
City/State/Zip \_\_\_\_\_  
Phone \_\_\_\_\_

Mail to: THE NORTHVILLE RECORD, Circulation, P.O. Box 470, Howell, MI 48844

**Fairfax MANOR**  
SPECIALISTS IN ALZHEIMER'S CARE

*Let our family care for your family.*

We understand the difficult decisions when home care is no longer an option. Let our home become your home being limited to just twenty residents makes our community close.

Fairfax Manor was specifically designed for private, personal Alzheimer's care. We provide a supportive, comfortable environment, preserving the natural dignity of your loved one.

Our staff are devoted, compassionate and specially trained in providing quality care. The expertise and compassion at Fairfax Manor shows in every aspect of care

Come see Fairfax Manor, where families care for families.

**1900 Prospect Road  
Ypsilanti, MI 48198**  
Just 5 miles east of Ann Arbor off Cecelia Road  
**313 483-6662**  
for information or a private appointment

**Put A Sparkle In Your Christmas!**

A Schonbek crystal chandelier becomes a family heirloom from the moment it's installed. The history of its design goes back 120 years when the Schonbek family began making crystal chandeliers in Bohemia, classical source of the world's finest crystal. If you're looking for a gift to outshine all others, you want a Schonbek crystal chandelier!

**Our Holiday Sale Lasts 10 Days ONLY!**

**SCHONBEK**  
Lighting for the New Age of Elegance™

Lighting Fixtures & Ceiling Fans for Every Decor • Wiring Supplies & Light Bulbs

**BROSE ELECTRICAL CONSTRUCTION, INC.**  
37400 W. Seven Mile Road • Livonia, MI 48152 • (313) 464-2211

Mon., Tues., Wed., Sat. 9:30-6:00  
Thurs., Fri. 9:30-5:00

**Heslop's**

**Turkey Sale**

**Save 20%**

Fri., Nov. 29-Sun., Dec. 8

**Take an Additional 20% Off**

Heslop's Everyday Low Prices on Most Dinnerware, Crystal Stemware, Flatware, Plus Select Giftware.

Let's talk turkey. Shop Heslop's Turkey Sale and you'll gobble up the savings!

Choose from famous names like Atlantis, Block, Christian Dior, Crystal J.G. Durand, Dansk, Fitz & Floyd, Gorham, Lenox, Mikasa, Nikko, Noritake, Onecida, Pickard, Reed & Barton, Rosenthal, Royal Doulton, Royal Worcester, Sasaki, Spode, Towle, and Villeroy & Boch.

Sale is not in addition to any other sale or previously marked-down merchandise. Normal exclusions apply. Please ask a salesperson for details.

Metro Detroit:  
Dearborn Heights, The Heights • (313) 274-8200  
(Ford Rd. between Inkster and Beech Daly)  
Livonia, Merri-Five Plaza • (313) 522-1850  
(On corner of Five Mile and Merriman)  
Novi, Novi Town Center • (810) 349-8090  
Rochester, Meadowbrook Village Mall • (810) 375-0823  
Roseville/St. Clair Shores • (810) 293-5461  
Sterling Heights, Eastlake Commons • (810) 247-8111  
(On corner of Hall Road and Hayes Road)

Troy, Oakland Mall • (810) 589-1433  
West Bloomfield, Orchard Mall • (810) 737-8080  
(Orchard Lake and 15 Mile)

Outstate:  
Ann Arbor, Colonnade • (313) 761-1002  
(On Eisenhower Pkwy., west of Briarwood Mall)  
Grand Rapids, Breton Village Mall • (616) 957-2145  
(Breton Rd. and Burton Rd.) Open Sundays!  
Okemos, Meridian Mall • (517) 349-4008

Coming Soon... Heslop's in St. Clair Shores!

**READ then RECYCLE**

# Attention

## power shoppers, hurry over to your Chevy Store and make your money count.



**3.9%**  
APR Financing\*

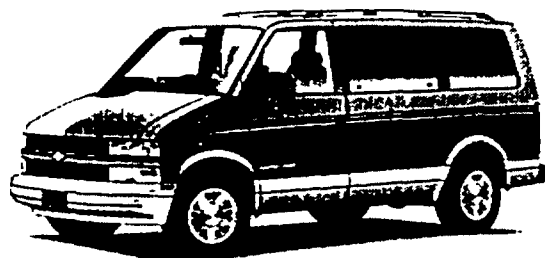

**Astro Van**  
3.9% APR financing is available on the Chevy Astro, the only truck tough enough to handle childhood.

**3.9%**  
APR Financing\*



**Cavalier**  
Cavalier is the car that's easy to own. And it's available with our special 3.9% APR financing offer.

**3.9%**  
APR Financing\*



**Lumina**  
The Lumina is so low-maintenance it can go up to 100,000 miles before its first scheduled tune-up! And with our 3.9% APR financing offer, it's a small price to pay for a lot less to worry about.

Up to **\$1200**  
Cash Back\*\*

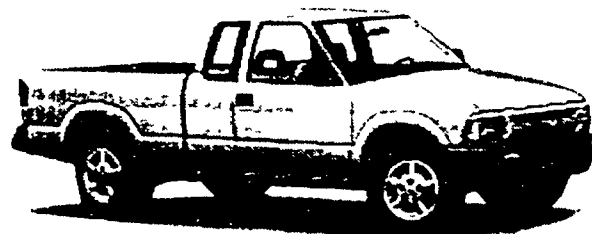

**S-10 Pickup**  
Get a special Cash Back offer and drive home your own rugged Chevy S-10 Pickup.

**SmartLease<sup>††</sup>**  
Offer



**Blazer**  
Get a great GMAC SmartLease offer on the Chevy Blazer with the exclusive\*\*\* Driver Control System.

**Hurry to your Chevy Store now for best selection.**

It's the perfect time of the year to power shop. And your Chevy Store is the perfect place. Because during the "Make Your Money Count" Year-end Event, you can drive away with great savings on the Chevy Blazer, Astro Van, S-10 Pickup, Lumina and Cavalier. But you only have until January 13 to take advantage of these special offers. So, hurry to your Chevy Store today and make your money count.

# City to seek street repair millage

Continued from 1

will ask citizens to rededicate 1.92 mills for streets."  
If approved the dedicated millage would amount to about \$400,000 per year and would provide sufficient funds to manage a "pay-as-you-go" street improvement program, which would cover every street in the city over the next 20 years, Gallogly added.  
Gallogly's approach tackles the street problems from two different vantage points.  
"First we need to tackle the streets most in need of repair, and

at the same time we need to provide maintenance to some of the newer streets so they won't fall into disrepair," he said.  
According to the plan the work is to be done in several phases with Center Street - which Gallogly calls the city's poorest roadway - heading the list.  
The plan also addresses the urgent needs of some of the city's better roads.  
"This plan is not etched in stone," he explained.  
"The city council can readjust priorities as we work through the plan."

The program also includes sidewalk repairs and replacement, traffic signals and signs, and storm sewer improvements, he remarked.  
There are other financial components included in the proposed plan.  
In addition to the dedicated millage, Gallogly recommended city officials seek supplemental funding, including state and federal aid, special districts, and public improvement funds.  
"We recommend that the city be aggressive in seeking out and securing state and federal funds

for street improvements," he said. "Any funds obtained can provide enhanced street improvements beyond that which is absolutely necessary to have safe, smooth, and quality roadways in our community."  
City officials decided a dedicated millage was preferred over bonding because it would be less costly to taxpayers.  
"This pay-as-you-go approach does not require interest payments like a bond issue would, and is more attractive from a taxpayer point of view," Gallogly maintained.

## Bill addresses school safety

Rep. Deborah Whyman's bill to allow expanded school traffic safety zones passed the House of Representatives 88-0, and drew the support of 37 members who asked to be named co-sponsors.  
Whyman, R-Canton, drafted the bill in response to a problem at her local Hulsing Elementary

School, where 315 children have to cross Morton Taylor Road which has a 40 mph speed limit.  
She thinks it will apply to many other schools in Michigan.  
The bill goes to the Senate, which has until the end of the year to act.

Wouldn't it be great if you could record your favorite shows without even turning on your VCR?

Now you can with...



from  
**Ameritech**

### Simple VCR Record

The wait is over. Our simple VCR recording feature automatically turns on your VCR and records the programs you select, with just the touch of a button.

Now you can enjoy the shows everyone's talking about, even if they're on when you're not home.

The cable service that's revolutionizing televisions across the country has arrived in your community.

### SPECIAL OFFER

Installation for only **\$4.95\***  
Call now!  
**1-800-848-CAST<sup>SM</sup>(2278)**

\*Limited time only. Standard installation includes up to two TV sets. Plus applicable fees and taxes. Certain restrictions apply. Call for details.



YOUR LINK TO BETTER COMMUNICATION<sup>SM</sup>

©1996 Ameritech Corp. 00062

# 'FOREVERGREEN' SALE! UP TO 50% Off

CHOOSE FROM HUNDREDS OF STYLES!

English Gardens' Best Selection of Life-Like Artificial Trees  
So real looking you can't tell them from fresh! 10 year warranty, metal tree stand, easy assembly and storage make ForeverGreens a holiday favorite!

**7 1/2 Foot Douglas Fir**  
"Columbia" by Hudson Valley  
Sale \$99.99



**7 1/2 Foot Douglas Fir**  
"Swiss Mountain" by Hudson Valley  
Sale \$149.99

**50% OFF**  
This Week Only



**Light Sets**  
By Silvestri  
100 light set  
3 year guarantee  
Sale \$9.99

**44% OFF**

## Fresh Wreaths

Decorated or Plain\* From just \$8.24



Sale! **25% OFF**  
Door Swags Too!  
\*Excludes remote wreaths



A Different Reason Every Season

CLINTON TOWNSHIP: 44850 Garfield Rd. at Holt Rd. 810-286-6100  
DEARBORN HEIGHTS: 22650 Ford Rd. at Outer Drive N. Hwy. 313-278-4433/Toll-free 313-565-8133  
EASTPOINTE: 22501 Kelly Rd. S. at 9 Mile 810-771-4200  
WEST BLOOMFIELD: 6370 Orchard Lake Rd. at Maple 810-851-7506

HOURS: MON. - SAT. 9am-9pm / SUN. DEC. 1 9am-7pm  
OPEN FRI. AND SAT. NOV. 29 & 30 8am-9pm

SALE ENDS 12/3/96  
CLOSED THANKSGIVING

**OVER 70 LOCATIONS IN THE METRO DETROIT AREA TO SERVE YOU.**  
**CALL 1-800-RENT-A-CAR**  
TO BE CONNECTED TO THE LOCATION NEAREST YOU.

## Unwrap A Bargain This Weekend.

Giving you a terrific package is what Enterprise does best - especially on weekends. Our wrapped car means you get low rates, and even a free ride to the rental office. So wherever your weekend plans take you, call Enterprise. And rent the car that'll get you there.

**Enterprise**  
1 800 rent-a-car  
Pick Enterprise. We'll pick you up.<sup>SM</sup>

We feature GM products like the Pontiac Grand Am.

### 3-DAY WEEKEND SPECIAL

**\$9.99**  
A DAY

Applies to a full size or smaller car rented from Friday through Monday for a three-day total of \$29.97, with 100 free miles per day included. Ask about discounted rates on other car classes and increased mileage packages. Taxes, excess mileage fees and optional damage waiver at \$11.99 per day are extra. Availability is limited and restrictions apply, so call for details.



# Lawmakers ask Congress for constitutional amendment

Sen. Loren Bennett, R-Canton, had to settle for a largely partisan victory when the state Senate approved his resolution seeking to curb "judicial taxation."

Senate Concurrent Resolution 278 asks the U.S. Congress to submit to the states a constitutional amendment prohibiting federal courts from ordering local governments to increase taxes to settle cases.

The vote was 23-9 with six not voting. Voting yes were 20 Republicans, including all area Republicans, plus three Democrats.

Bennett said the Supreme Court in a 1990 Missouri case upheld the right of a federal court to impose state and local taxes, and 246 similar cases have been brought to the courts.

"The Supreme Court, with one sweeping decision, doffed the robe of judge and donned the role of legislator." In that case, the court ordered Kansas City property tax rates raised from \$20.50 to \$40 per \$1,000 of valuation - a total of 1.6 billion.

Four Democratic senators - including Hart and Smith - issued formal protests in the Senate Journal, saying Bennett's resolution would "limit the ability of the federal courts to address historical discrimination ... The only thing state government has to say is, 'We're not going to pay.'"

### NO EXPUNGEMENT

Five criminal sexual offenses will be added to the list that will

remain on an offender's record forever under a bill sponsored by Sen. Mike Rogers, R-Brighton.

The Senate Judiciary Committee reported out Rogers' bill to add first-, second- and third-degree criminal sexual assault, assault with intent to commit sexual penetration, and assault with intent to commit second-degree conduct.

Currently, only crimes involving life sentences and traffic offenses remain on an offender's record for life. "A sexual offender cannot hide behind a record from which serious crimes have been expunged," said Rogers.

Clinton County Prosecutor Chuck Sherman, in testimony, said, "Sex offenders are more likely to re-offend than any other class of criminals. This bill will help assure that anyone convicted of a sex offense can never again work their way into a position of trust or authority over potential victims."

"Long over due," added Livingston Prosecutor David Morse of

the bill. "Parents have a right to know if sex offenders are living or working in their community."

The Senate will return to action Dec. 3 after a two-week recess for deer season and Thanksgiving. Rogers' bill also must make it through a crowded House agenda by year's end to become law. If not, it will have to be reintroduced in 1997.

### MACK APPOINTED

Wayne County Probate Judge Milton Mack is part of a 21-member task force appointed by the state Supreme Court to find better ways to protect the interests of persons under the care of a guardian or conservator.

Beginning work in January, the panel of judges, lawyers and other officials will explore ways to improve court rules, management policies, and statutes while maximizing the independence of protected persons. Calhoun Probate Judge Philip Harter will chair the panel.



Photo by ROBERT JACKSON

### Storytime

Northville School District Superintendent Leonard Rezmierski takes a few moments out of his schedule to read to Stephanie

Ruiter's wondrous garden class. Rezmierski serves as the guest storytime reader once a month at the Main Street School.

### Kmart Customers

There are corrections to our Nov. 29 circular. On pg. 2, a \$10 rebate was pictured with the Polaroid 2-pack instant film. This product does not have a rebate. Page 17 pictured Emerson Car Audio System model #2050SP. It should have shown model #1001 at \$19.99. All other car stereos are at 20% off our reg. price.

We apologize for any inconvenience.



# THE YEAR IN REVIEW

In this special section, we'll be looking back at 1996. The big stories, the changes, the happenings and the pictures of people and places that made 1996 memorable. **THE MILFORD TIMES, THE NORTHVILLE RECORD** and **THE NOVI NEWS** will each take a fond look back...

Call today to reserve your space!  
 Milford Times ..... (810) 685-1507  
 Northville Record & Novi News ..... (810) 349-1700

Proof Ad Deadline: Friday, December 6  
 Final Ad Deadline: Tuesday, December 10  
 Publication Date: Thursday, December 26

### AD RATES:

Full page.....	\$350
Half page.....	\$210
Quarter page.....	\$125
Eighth page.....	\$75

1 color: \$90

15% discount for 2 sections,  
 25% discount for 3 sections

**Prestige**  
**1 HOUR Dry Cleaners**

**50% OFF**  
**INCOMING DRYCLEANING**  
**ONE DAY ONLY - NOV. 29TH**

EXCLUDING LEATHER, SUEDE & WEDDING GOWNS  
 COUPON MUST BE PRESENTED WHEN ORDER IS LEFT

37633 Five Mile (at Newburgh) (313) 464-0003  
 19219 Newburgh (at 7 Mile) (313) 462-2471  
 17126 Farmington Rd. (at 6 Mile) (313) 261-3166

**VIPERS DON'T MISS IT!!**

Vipers Tickets Make Great Holiday Gifts!

**11/30 vs. CINCINNATI**  
 FREE Player Poster to the first 5,000 fans courtesy of

**12/1 vs. HOUSTON**  
 FREE Player Poster to the first 5,000 fans courtesy of

**12/9 vs. LAS VEGAS**  
**12/11 vs. MANITOBA**

**ON SALE NOW**

THE BOX OFFICE AND ALL CHARGE: (810) 645-6666. GROUP DISCOUNTS AVAILABLE.  
 CALL (810) 377-0100 FOR INFORMATION.  
 www.detroitvipers.com

**Your Christmas Store**

- Over 50 different styles of natural looking trees
- Fantastic selection of indoor and outdoor lights
- Hundreds of tree trimmings in a variety of themes
- M. Fontaine nativity sets
- Variety of Beautiful Wreaths and Garlands
- Seraphim Classics Angels

**CORNWELL Christmas World**  
 874 W. Ann Arbor Road  
 PLYMOUTH  
 (313) 459-7410

PRE-LIT CHRISTMAS TREES by Roman Inc@

Roman, Inc.  
 Hours: Mon.-Thurs.-Fri. 10-8, Tues.-Sat. 10-6, Sun. 12-5, Closed Wed.

# 'Toys' campaign makes appeal

By RANDY COBLE  
Staff Writer

It's getting to be that time of year again. Frost on the windowpanes, a chill in the air and presents beginning to pile up under the tree.

Sadly, that last part's not true for everybody, including some of our neighbors right here in Northville and Novi. You can change that, though, and make a needy kid's Christmas bright next month by taking part in the Toys for Tots program.

"Christmas is the one time of year when every kid would give up a meal for a present," local program coordinator Rebecca Yarbrough said. "My goal is to have no kid without a toy to unwrap on Christmas morning."

The Novi/Northville Coalition for Toys for Tots aims to make that happen for kids who live in several area communities, including right here at home.

"There are needy families right here in Northville and Novi. We just hide them well," Yarbrough said.

Toys for Tots began in 1947 with a Marine colonel named Bill Hendricks. He'd met a needy child in Los Angeles and wanted to make sure the boy had a toy for Christmas. He found many agencies and

organizations that provided food, clothing and other staples but no one was specifically set up to distribute toys to poor kids.

That changed when Hendricks founded Toys for Tots.

In the half-century since then his organization, in cooperation with the Marine Corps Reserves, has provided Christmas toys to an estimated 100 million or more children.

Walt Disney himself designed the program's locomotive logo and celebrities ranging from John Wayne to Nat "King" Cole have pitched in to raise public awareness about Toys for Tots.

The Coalition got in on the act four years ago with the cooperation of members of Northville's American Legion Post 147 and VFW Post 4012 and Novi's American Legion Post 19.

Last year the organization distributed more than 6,000 toys to kids who otherwise would have gotten nothing on Christmas.

For Yarbrough, who's been involved with Toys for Tots for 15 years now, that bottom line makes it all worthwhile.

If you want to find out how it feels for yourself buy a new, unwrapped toy and drop it off at one of several Toys for Tots dropoff locations.

If you do, Yarbrough asks donors to put some careful thought into their gifts.

"Think about if it was your kid and you only could give them one toy under the tree. What would it be? Make it something special," she said.

Make your move soon as toys will only be collected for the next three to four weeks.

Coalition volunteers will then sort donated toys by age and sex and distribute them to community organizations like the Goodfellows, Jaycees, the Salvation Army, churches and battered women's shelters.

"This frees them up to concentrate on finding food and money and other resources," Yarbrough explained. "Toys for Tots takes a burden off of them."

To find out how you can contribute to Toys For Tots or volunteer your workplace as a drop-off point, call Yarbrough at (313) 477-6449.

## Library Lines

**LIBRARY HOURS:** The Northville District Library's fall/winter/spring hours are: Monday-Thursday, 10 a.m.-9 p.m.; Friday and Saturday, 10 a.m.-5 p.m.; Sunday, 1-5 p.m.

For more information please contact (810) 349-3020 during open hours.

**LIBRARY BOARD MEETING:** The next meeting of the Northville District Library Board will take place Thursday, Dec. 5, at 7:30 p.m. at the new library. All are welcome to attend.

**THANKSGIVING CLOSING:** The Northville District Library will be closed Thursday, Nov. 28, for Thanksgiving Day observances. The library resumes its regular schedule Friday, Nov. 29.

**BOOK DISCUSSION GROUP:** Like books? Come to the library on Monday, Dec. 2, from 7-8 p.m. and be a part of the book discussion group. The featured title is *Midnight in the Garden of Good and Evil* by John Berendt. The program is free and all are welcome to attend.

**INTERNET CLASS:** Are you interested in "surfing" the Internet but lack the know-how to do it? Come to the Northville District Library on Tuesday,

Dec. 3, from 7-8 p.m. Richard Truxall, the head of continuing education for the Library Network, will present a program that will help patrons use the Internet. The program is free and open to all.

**COMMUNICABLE DISEASES:** The Northville District Library presents another program in its "Our Health". On Wednesday, Dec. 4, from 2-3 p.m., Providence Hospital community educator Beverly Mihalko will discuss communicable disease prevention including tips on keeping your house healthy. The program is free and all are welcome to attend.

**HOLIDAY CRAFT WORKSHOP:** Children of all ages are welcome to attend a free holiday craft workshop on Thursday, Dec. 5, from 4-6 p.m. Participants will make fun holiday crafts for Hanukkah, Christmas and Kwanzaa. The drop-in program requires no registration.

**FAMILY HOLIDAY STORYTIME:** Join us on Dec. 10 at 7 p.m. for an evening of seasonal stories and puppets. Storytellers Mrs. Dewey, Dorie and Jenn will weave tales of Hanukkah, Christmas, and Kwanzaa to delight children of all ages (and their parents). The program is free and open to all.

## Christmas in Plymouth...

23rd Annual Christmas Arts & Crafts Show  
Friday, Saturday & Sunday  
NOVEMBER 29, 30 & DEC. 1  
DECEMBER 6, 7 & 8  
Hours: Fri. & Sat. 10-5; Sun. 12-5

**\$1 ADMISSION - FREE PARKING**

For more information call **455-6620**  
Show sponsored by The City of Plymouth Dept. of Parks & Recreation

### MIKIMOTO

CLASSIC CULTURE.

Timeless elegance is captured night and day in Mikimoto's cultured pearl necklaces and matching single pearl earrings.

Featured: 16" necklaces, 6-5.5mm to 8-7.5mm, from \$1,750 to \$4,900.  
Earrings, 6.0mm to 8.0mm, from \$170 to \$830.

**MASTERCRAFT JEWELERS**

DESIGNERS • MANUFACTURERS • DIAMOND IMPORTERS  
LAUREL PARK PLACE  
6 Mile & I-275 • Livonia  
(313) 464-3555

# THREE DAYS ONLY!

FRIDAY, SATURDAY & SUNDAY

OUR ENTIRE STORE

BUY ONE ITEM, GET THE SECOND

# 50%<sup>\*</sup>

# OFF

Our Already Discounted Prices

## THE WORD IS OUT ABOUT OUR HOLIDAY PLAY!

DON'T MISS *Charlotte's Web*, DEC. 7 - JAN. 4 AT HENRY FORD MUSEUM

Enjoy an all-time favorite of young and old alike! *Charlotte's Web*, the classic, inspirational tale of a spider who befriends a little pig, will be presented in collaboration with Wild Swan Theater in the museum's Anderson Center Theater. It's great for kids 5 years and up and lasts about an hour. It's also just one of the activities to enjoy during *Traditions of the Season* -- a time when the museum and village are aglow with holiday spirit. See a mammoth holiday tree, a spectacular gingerbread village, a model train display and more. You'll have a *terrific* time!

Performances: \$8.00 per person (not including museum admission)

Dec. 7, 14, 21, 28 & Jan. 4 11:30 am, 2:30 pm  
Dec. 8, 15, 22, 29 & Jan. 2, 3 2:30 pm

To order tickets for *Charlotte's Web*, call (313) 271-1620, ext. 383.

# DRESS BARN

Also at Dress Barn Woman!

**VISIT OUR NEWEST LOCATIONS**

Dress Barn/Dress Barn Woman

Factory Outlet Stores  
1161 East Clark Road, Dewitt • (517) 669-8808

Oakland Plaza  
310 John Road, Troy • (810) 585-1169

Eastbrook Mall  
3643K 28th St., Grand Rapids • (616) 940-9150

**OTHER DRESS BARN LOCATIONS**

• ANN ARBOR	• DOWNTOWN DETROIT	• LANSING	• ROCHESTER HILLS
• BRCH RUN	• FARMINGTON	• LIVONIA	• SHELBY TOWNSHIP
• BLOOMFIELD HILLS	• FLINT	• MONROE	• STERLING HEIGHTS
• CANTON	• GROSSE POINT	• MT. CLEMENS	• WARREN
• CLAWSON	• HOLLAND	• NOVI	• WESTLAND CROSSING
• DEARBORN HEIGHTS			

FOR SIZES 14-24 SHOP DRESS BARN WOMAN  
• BIRCHRUN • MONROE • MT. CLEMENS • SHELBY TOWNSHIP • WARREN

\*50% SALE ITEMS NOT INCLUDED. TAKE 50% OFF LOWER PRICED ITEM. OPEN 7 DAYS, 6 NIGHTS. NO SALE IS EVER FINAL. MAJOR CREDIT CARDS ACCEPTED.



### Maybury State Park

**PARK HOURS:** Maybury State Park is open daily from 8 a.m. until dusk. Farm hours are 8 a.m.-5 p.m. daily. A state park motor vehicle permit is required for entry to the park. Additional information about programs or facilities may be obtained by calling the park office at 349-8390.

**HOLIDAY TREES:** A holiday tree sale, sponsored by the

Friends of Maybury State Park, will be held on Dec. 7, 8, 14 and 15, from 1-3 p.m. each day.

The fee includes a hayride, your choice of a pre-cut tree, and entry into the park for the day. The cost is \$30 per family.

The hayrides will begin at the concession building in the main parking lot on Eight Mile Road.

**MOTOR VEHICLE PERMITS:** The 1997 annual state park

motor vehicle permits are now available. For just \$26 per vehicle, you can enjoy a year's worth of activities at any of Michigan's 96 state parks and recreation areas. They also make great gifts.

To purchase yours, stop by the park office during our business hours.

You may also buy them in the sporting goods department at Meijer.

2649 MICHIGAN RESIDENTS

PAID THE ULTIMATE PRICE FOR THEIR MEDALS.



EARN YOURS FOR A FEW DOLLARS AND CHANGE.

Over 400,000 people from Michigan made their contribution during Vietnam. They overcame adversity on a daily basis with braver, sacrifice and determination. Thousands of them never made it back home.

Heroes aren't required to honor Michigan's Vietnam veterans. By giving a penny for every Michigan citizen who died during Vietnam—a total of \$26.49—you can help make a monumental difference.

MICHIGAN VIETNAM MONUMENT 1-800-492-2649

611 WEST OTTAWA LANSING MI 48913

HURRY...  
FINAL DAYS!

**INSTANT  
HOLIDAY  
MONEY  
IS HERE!**

**\$10 OFF** ANY MERCHANDISE TOTAL OF \$60 OR MORE  
**\$20 OFF** ANY MERCHANDISE TOTAL OF \$100 OR MORE  
**\$30 OFF** ANY MERCHANDISE TOTAL OF \$150 OR MORE  
PLUS \$10 OFF EACH ADDITIONAL \$50 MERCHANDISE PURCHASE OVER \$200

CHOOSE FROM OUR ENTIRE STOCK OF  
MEN'S AND WOMEN'S  
FALL AND WINTER FASHIONS



NEWBURGH PLAZA

37205 WEST SIX MILE ROAD AT  
NEWBURGH ROAD LIVONIA  
(313) 591-9244

HURRY...HOLIDAY MONEY ENDS SUN., DEC. 1ST

EXCLUDES LAYAWAY SALES, GIFT CERTIFICATES AND PRIOR PURCHASES. NOT VALID TOWARDS SPRING 1997 MERCHANDISE EXTENDED HOLIDAY SHOPPING HOURS: MONDAY thru FRIDAY 10-9 SATURDAY 10-7 SUNDAY 12-5

New  
Women's Center  
Opening February 1997

# My Health. My Needs. My Hospital.

"The women's programs at St. Mary Hospital meet all my needs."

My doctor said I needed a few tests, and told me about St. Mary Hospital's new Marian Women's Center. It's close to home, and the staff is committed to keeping women healthy. I found a warm, caring atmosphere designed to help women feel comfortable.

The center provides education and support programs for women of all ages. Diagnostic testing like mammography, radiology, and ultrasound are also available, as well as a complete breast health clinic.

The Marian Women's Center, adjacent to the new Miracle of Life Maternity Center, provides



family services like childbirth education, a breastfeeding program, and even pre- and postnatal exercise classes. We're planning to start a family soon, and all the programs I need are now available close to home.

My mother was interested in the Marian Women's Center menopause support group, which educates women and removes some of the mystery about this time of life.

And if I want more information about health topics concerning women, I can attend specialized seminars throughout the year. The Marian Women's Center cares about women. That's why St. Mary Hospital is my hospital.

Physician Referral Service  
1-888-464-WELL

Marian Women's Center  
(313) 655-3314  
or toll free  
1-800-494-1615

Visit St. Mary via Internet  
<http://www.stmaryhospital.org>

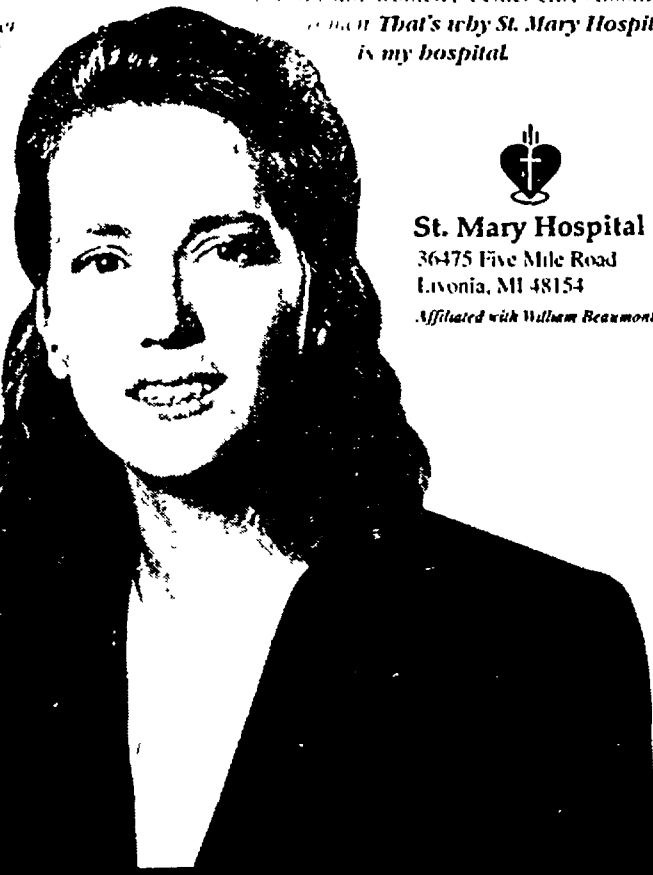

St. Mary Hospital

36475 Five Mile Road  
Livonia, MI 48154

Affiliated with William Beaumont Hospital

The FirstRate Fund.  
The Connections Savings Account.

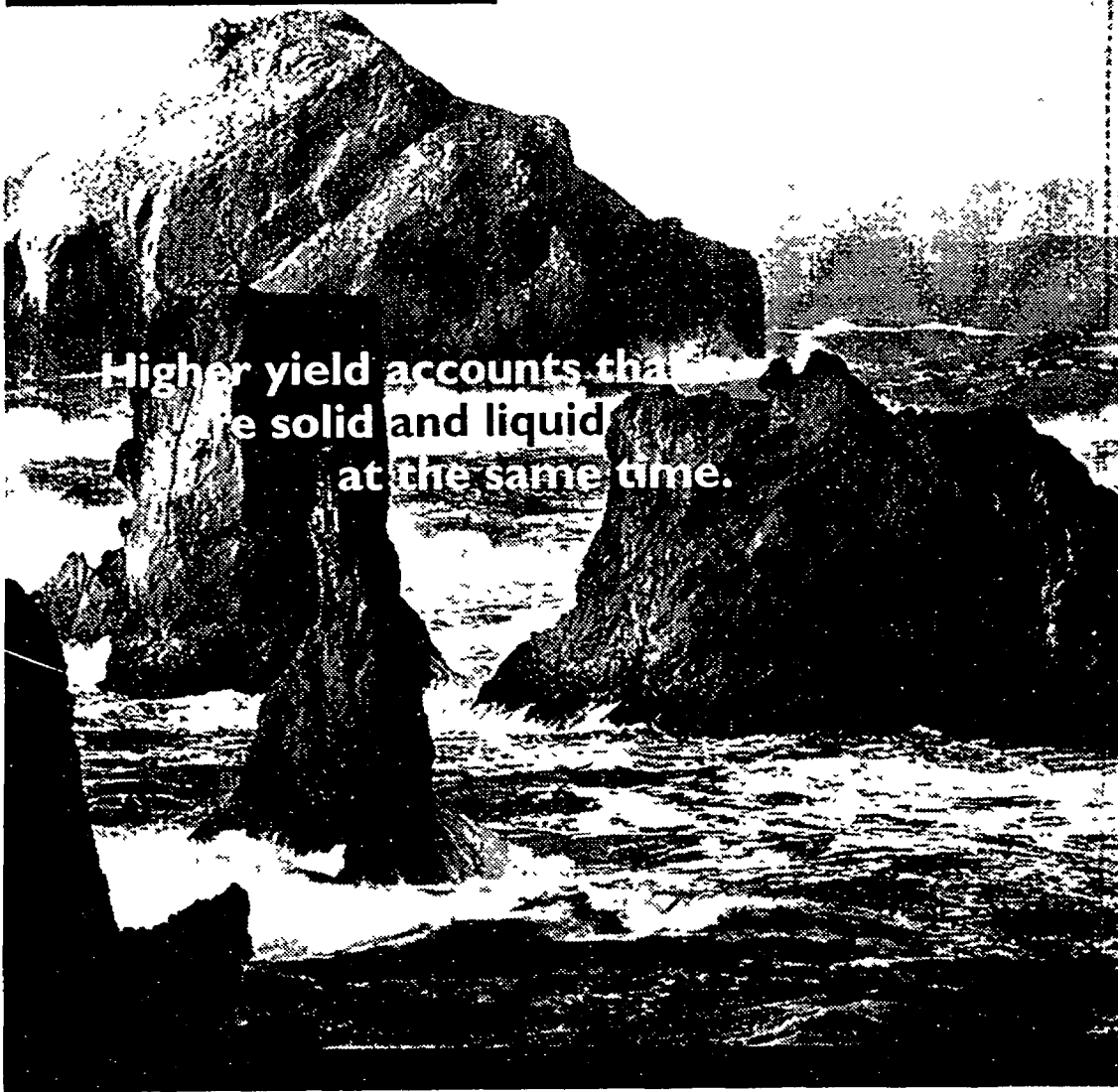

Higher yield accounts that  
are solid and liquid  
at the same time.

Now there are two rock solid ways to make your money grow while you still have access to it.

**FirstRate**  
**5.00%**  
\$10,000 Minimum

The FirstRate Fund. A \$10,000 minimum opening deposit account. Earn a rate tied to the highly competitive 91-day T-Bill for balances of \$10,000 or more.

And the Connections Savings Account. Get high rate savings with a \$1,000 minimum opening deposit when you have at least one other First of America account.

Both are risk-free. Accounts are fully liquid. Both are risk-free. And if you're an existing FirstRate Fund or Connections Savings

customer, we'll give you these bonus rates when you make an additional deposit and bring in a copy of this ad. In the case of FirstRate Fund customers, make a deposit of \$5,000 and we'll give you this special rate on your entire balance if your new balance is \$10,000 or more. And it only takes \$1,000 for Connections Savings customers.

**First of America**  
**3.50%**  
\$1,000 Minimum

So stop by any First of America Bank office or call 1-800-222-4FOA to open your account by mail.

First of America. We're the bank that is working a little harder for you.

FIRST OF AMERICA Bank

Annual Percentage Yields (APYs) accurate as of 10/21/96 and subject to change without notice after account opening. Fees may reduce earnings on your account. The APY for FirstRate Fund balances of \$10,000 or more is tied to the 91-Day T-Bill rate. The APY for balances below \$10,000 is determined by the bank and currently being set equal to 1.25%. Offer available to individuals at First of America Bank - Michigan offices only. Member FDIC. Equal Housing Lender. If hearing impaired, our TDD line is available from 9-5 EST at 1-800-289-4614. ©1996 First of America Bank Corporation.

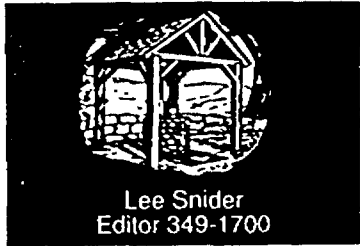

Our Opinion

Tougher standards will send clear signal

Northville High School administrators are upping the ante in their efforts to keep alcohol and drugs out of the school.

Officials are targeting repeat student offenders with stricter disciplinary measures and are warning all students that one drink could result in some pretty severe punishments.

The school recently purchased a saliva testing device that can determine a student's blood alcohol level. The test will hopefully deter teens from drinking before and during the school day.

At the same time school officials also revised the student code of conduct, adding an additional five-day suspension for any student caught under the influence of drugs or alcohol.

We're encouraged by this recent turn of events. It is no secret that Northville High School has not fared well in recent Alcohol and Other Drug surveys.

Survey statistics show a continued increase in alcohol and drug use by high school students over the last five years.

So instead of throwing more money into programs that have dubious success rates, school officials are taking a new, tougher approach. By implementing these measures school officials are communicating a simple message to students and parents - alcohol and drugs will not be tolerated at the high school.

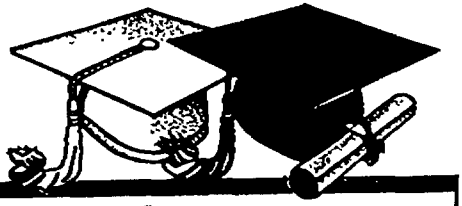

Education

If students ignore the message they will face harsher penalties.

The new policies also bring parents into the mix. Students suspended for alcohol or drug use will be recommended for participation in the Facing Alcohol Challenges Together Program.

We couldn't agree more. The community and school district have spent thousands of dollars fighting substance abuse by the students.

The end result is that, with no parental intervention, the at-risk student continues his or her downward spiral.

So now the high school has taken a different, two-pronged approach - handing out severe punishments to those who abuse at school, and forcing parents to become involved.

We support this strategy, and congratulate school officials for taking off the gloves and sending a clear message to students who continue to abuse drugs and alcohol.

Time's ripe for new beginning

Members of the new Northville Township Board of Trustees were sworn into office for fresh four-year terms on Wednesday, Nov. 20.

Swearing in Supervisor Karen Woodside was family friend and distinguished legal expert Roman Gribbs. Many people remember Gribbs from his tenure as mayor of Detroit.

Gribbs, now a 1st District Court of Appeals judge, told the gathering he's been a resident of Northville Township for three years. After addressing the audience briefly, he administered the oath of office to Woodside then embraced the supervisor to the enthusiastic applause of those present.

In an ironic twist, 35th District Court Judge John MacDonald administered the oath to new Treasurer Dick Henningsen. In his remarks, Judge MacDonald pointed out that Henningsen was an elected member of the board of trustees when he, MacDonald, served as supervisor of the township.

Wayne County Probate Judge James Lacey was the third justice doing the inaugural honors. In addition to Woodside and Henningsen, Clerk Sue Hillebrand and trustees Mark Abbo, Russ

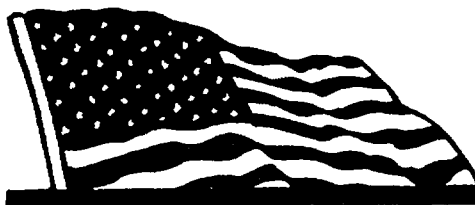

Government

Fogg, Bill Selinsky and Marv Gans were also sworn in last week.

Among the spectators were Wayne County Prosecutor John O'Hair, Woodside's boss, and state Rep. Robert Geake, R-Northville.

Everywhere there were broad smiles, well wishes, handshakes, hugs.

Swearing in ceremonies are always upbeat affairs filled with bright outlooks on the future. But in this case we believe Northville Township government has a real opportunity to reinvent itself. With a new manager coming in and four new trustees on board who carry no political baggage, now is a good time to make a new start.

With the rancor and disorganization of the previous administration now a thing of the past, the township's elected representatives should resolve to work in harmony where possible, disagree respectfully when necessary and move ahead with the people's business.

As with all beginnings, there's cause for hope.

Don't discount the message

It seems Barb Flis has touched a nerve. When the longtime Northville education advocate dressed down the school board and superintendent for their perceived complacency two weeks ago, quite a few people gave us a call or wrote letters to the editor to tell us they felt the criticism was long overdue.



Robert Jackson

District officials maintain change comes slowly and painfully, and that Northville has moved forward in a controlled manner.

Critics on the other hand believe that the district is essentially stuck in the mud, spinning its wheels, and that failed leadership at the top has had a crippling effect on education.

The criticisms raise an interesting question - just how many members of our community believe there are real problems plaguing our school district and its leadership?

It might not take us long to find out. Beginning in December hundreds of community residents will get the opportunity to speak their minds regarding the state of education in Northville.

The survey will provide answers district officials say

they need to continue charting a "path of progress" for Northville schools. It should also give the district a better understanding as to why the recent bond and millage issues failed.

While I encourage everyone called to participate in the survey - community feedback is extremely important and necessary - I am concerned that with all the emphasis being placed on this survey we might all ignore something extremely important.

Like the message Barb Flis delivered two weeks ago. The issue is not necessarily whether 40 people or 4,000 people agree with her. The fact that Flis - who is involved in education issues at the local, state, and federal levels - has spent the better part of seven years serving on various district committees is important to note.

Regardless of what they find in the results of the survey, district officials should not tune out the comments made by Flis. They should, instead, embrace the criticism and apply what has been learned to make the district a better place to educate the children of this community.

That is what strong leaders do in all walks of life, recognizing that true success cannot come without standing up to criticism and overcoming adversity.

And those are traits that cannot be measured on any survey.

Robert Jackson is a staff writer for the Northville Record.

In Focus

By John Heider



Images

Oakland Community College photography student Carlos Quesada disappears behind a black cloth Monday morning at Maybury State Park while making images with his 4-by-5 "view" camera.

Preconceptions can backfire

With pen and pad in one hand and tape recorder in the other I headed to the Northville Town Hall Lecture on Monday, Nov. 18, to hear the guest speaker, attorney Sharon McPhail.



Carol Workens

McPhail told the audience to erase everything they had heard or read about her because the statements weren't true and she, having the most experience on the subject, would tell us the truth.

Not many eraser crumbs fell under my chair because I didn't really know that much about McPhail.

McPhail talked about a variety of things, including prejudice and the stories that go on in people's heads on just about everything. Sometimes people write a story about someone they have seen but to whom they have not been formally introduced and find out later that the person is not at all like what they had thought.

A day or two after the lecture, while headed home in my car, I heard a news report on the radio indicating that McPhail at the Town Hall lecture had said that Detroit Mayor Dennis Archer was building "monuments to greed."

I didn't remember hearing her say that, I immediately thought, "Checking my tape I realized that she did say 'monuments to greed' but the recording was so poor recording I couldn't make out the words leading up to that phrase."

McPhail had been quoting a passage from the Bible about loving one another as God has loved you just prior to the phrase "monuments of greed," which was immediately followed by a mention of us not needing

more money or Gucci sweaters.

Even though I had no information about McPhail other than what she had told us at the lecture, I could not understand how Archer's name could be linked to her quote.

During the luncheon that followed the lecture, the women at the table were commenting on how they thought McPhail had been quite complimentary to Archer.

To be on the safe side I called McPhail to clarify whether or not I had not misinterpreted what she had said.

"We were building monuments to greed is what I said," McPhail told me during her return telephone call.

"What I was talking about was that the people of the city voted for gambling. As far as I know those (stadiums) were decided on before he (Archer) got there. Coleman Young was working on that stuff."

As reporters we, like anybody else, have stories going on in our heads.

I am, as the saying goes, an open book when it comes to McPhail.

If reporters are going to interpret a phrase out of context they are naturally going to draw from the previous information they keep stored about in their minds.

At the community level, reporters try to be as careful as possible to make sure their facts are right. We are working down the street from where you shop and work.

The radio reporter had a story going on in his head. I too have a story going, but I am only on page one of this book.

Carol Workens is a staff writer for The Northville Record.

The Northville Record

STAFF

- Vice President/General Manager..... Richard Perlberg
Executive Editor ..... Philip Jerome
Managing Editor ..... Michael Malott
Editor ..... Lee Snider
Staff Reporter ..... Robert Jackson
Staff Reporter ..... Randy Coble
Staff Reporter ..... Wendy Pierman Mitzel
Staff Reporter ..... Scott Daniel
Staff Reporter ..... Jan Jeffres
Staff Reporter ..... Carol Workens
Staff Photographer ..... John Heider
Staff Photographer ..... Hal Gould
Graphics Editor ..... Chris Boyd
Graphics Artist ..... Juanita Little
Sales Director ..... Michael Previle
Associate Sales Manager ..... Gary Keiber
Sales Representative ..... Robin Lawson
Sales Representative ..... Janis McMann
Receptionist ..... Gina Mathews
Receptionist ..... Diane Quint

Publication Number USPS 396880

Member:
• Michigan Press Association
• Suburban Newspapers of America
• National Newspaper Association

Represented nationally by:
• U.S. Suburban Press, Inc.
• Michigan Newspaper Coop., Inc.
• American Newspapers Representatives, Inc.

Business, news, and advertising offices located at 104 W. Main St., Northville, MI 48167. Telephone (810) 349-1700, Fax (810) 349-1050. Send address changes to The Northville Record, P.O. Box 899, Brighton, MI 48116.

HOME TOWN
A subsidiary of Suburban Communications Corp.



### Mill Race Matters

As families across the nation gather for Thanksgiving, the Northville Historical Society family would like to take time to thank all of those who have worked this year and in the past to keep Mill Race Village a viable part of the Northville community.

During its 25 years of existence, the village has been fortunate to receive the dedicated attention of countless hundreds if not thousands of volunteers. An attempt at a list would prove useless as many of these individuals went about their work silently and without recognition. Those who have helped to restore a building, maintain grounds, create a new project, organize a social activity, assist in a fund-raising endeavor, develop a program, donate materials or money, or simply assist where and when needed are too countless to name.

Special attention can go this year to the Historical Society's new office manager Diann Dupuis for her exceptional organizational ability and special gift for communicating with visitors, contributors, and potential clientele. Marietta Rathbun and Elayne Elliott assumed organization of the weekly docent force and regenerated a needed segment of the organization.

Members of the board of directors, Carolyn Stuart, co-president; Fran Gazlay, co-president; Art Rockall, vice president; and directors Melody Arndt, Joelle Sarkozy, Sonia Swigart, Bob Juhasz, Earl Bryant, Susan Sherwood, Joanne Harris, Marianne Barry and Betty Omar worked monthly to resolve issues of concern for the organization.

Betty Omar and Diane Rockall chaired the organization's biggest fund-raiser, Tivoli Fair, which contributes the major share of the village's operating budget.

Approximately 12 individuals devoted more than 40 hours each to this project with numerous others contributing lesser amounts of time.

Regular groups such as the Stone Gang, garden groups, and the Archives Committee met weekly to maintain regular activities for the village as well as the Historical Society. Other committees such as the Quarterly committee, the Home Decoration committee, and the Finance committee meet periodically throughout the year to handle needs as they arise. And special groups like the Victorian Festival committee and the Fourth of July group devote lengthy hours during designated periods of the year.

City workers from the department of Public Works and the Recreation Department spent time and energy to keep the village attractive and viable for the community. Numerous members of the community shared memorabilia from their homes and their family histories while others contributed much needed financial assistance.

To all of these and to the others not included in this list a special thank you from the Mill Race Village family, from the Northville Historical Society, and from the community which enjoys the benefits of a magnificent community resource for all to share.

Membership renewals will be going out soon. Remember to renew as notices are sent only once. Those who have not yet joined can contact the office Monday through Friday between the hours of 9 a.m. and 1 p.m. at 348-1845.

The Plymouth Historical Museum exhibit "Visions of Christmas" runs through Jan. 26. It features Santa

Claus figures, angels and nutcrackers. Over 250 Santas from the collection of Dr. Weldon Petz are included in the display. The museum is open Wednesday, Thursday and Saturday from 1 until 4 p.m. and Sunday from 2 until 5 p.m. Admission is charged.

Oakland County Galleria presents "Mapping the Course of County History" now through Dec. 30, Monday through Friday from 8:30 a.m. until 5 p.m. The maps on display come from the Oakland County Pioneer and Historical Society Library. Call (810) 858-0415 for more information.

The Salem Historical Society announces the following upcoming schedule: Jan. 23, Civil War Reenactment, a Michigan Perspective by Herb Leidel; Feb. 22, a tour of the Second Baptist Church in Detroit, and June 13, SAHS Flag Day Exhibit, Reception and Preview. Contact (313) 663-2606 for more information on Salem programs or to present a program idea.

-Diane Rockall

#### CALENDAR

Thursday, Nov. 28	Happy Thanksgiving	..... Village Closed
Sunday, Dec. 1	Baseline Questers	..... Cady, 4 p.m.
Tuesday, Dec. 3	Stone Gang	..... Village, 9 a.m.-noon
Country Garden Club	..... Cady, 11:30 a.m.	
Wednesday, Dec. 4	Archives	..... Cady, 9-11 a.m.
Basket Guild	..... Cady, 9:30 a.m.	

IN NEED OF  
A NEW FURNACE  
**LENOX**  
FREE ESTIMATES  
(313) 525-1930  
UNITED TEMPERATURE  
8919 MIDDLEBELT • LIVONIA

**Bueter's OUTDOORS**  
Specialists in the Artful Pursuit of Fish and Fowl.  
**Early Bird Special**  
**Denim Collar Sport Shirts**  
Regular ~~32.99~~ **24.97**  
~~29.95~~ **22.46**

**LEWIS CREEK**  
American Countrywear  
**Special Package Pricing**  
• Jackets, liners, accessories  
**Helly Hansen**  
Lifa and Propile  
★ NEW SHIPMENTS ARRIVING ★  
**Bueter's OUTDOORS** 120 E. Main  
Downtown Northville  
810-349-3677

**LOVE DESIGNER FASHIONS?**  
We saved the best fashions, jewelry, hand bags, shoes from the finest Bloomfield closets for this sale

• TONS OF STERLING UNIQUE PIECES	• ALL ITEMS NEVER SEEN BEFORE	• HUGE AMOUNTS OF DESIGNER HANDBAGS
----------------------------------	-------------------------------	-------------------------------------

FRIDAY, NOV. 29 **40% Off** MOST EXPENSIVE OF 2 ITEMS  
**10-6 p.m.**

SATURDAY, NOV. 30 **50% Off** MOST EXPENSIVE OF 2 ITEMS

Special Location: formerly Dollar Store, 42947 W. 7 Mile - Northville, Highland Lakes Shopping Center  
Cash Only

**CONSIGNMENT**  
Clothiers

*We're Looking for A Miracle And That Miracle is You!!*

PLEASE DONATE YOUR MOTORIZED VEHICLE DIRECTLY TO THE

**SOCIETY OF ST. VINCENT DEPAUL**  
1-800-309-28886 or 313-972-3100  
We Help 1,000's of people through job placement, food depots and children's camps.

**YAWN ALL THE WAY TO THE BANK.**

U.S. Savings Bonds may not be exciting, but they are a safe, easy way to save for the future.

**U.S. SAVINGS BONDS**  
A Public Service of the Government

**SAVE 20% - 60% DISCOUNT PIANO WAREHOUSE**

ATTENTION PARENTS! You can afford a nice piano for your child's lessons

**NEW PIANOS**  
American-made  
**SAVE 30%**  
Discontinued Model  
**CLOSE-OUT**

Large Selection USED PIANOS From **\$695**

**USED • O • R • G • A • N • S**  
All Hammonds, Conn, Wurlitzer, Allen, Lowry, Baldwin, Gem, Yamaha  
**30% - 60% OFF**

**ROSEVILLE** 25118 GRANDOT (1/2 MI SOUTH OF 614) (810) 445-8340  
**GRINNELL PIANO DISCOUNT PIANO WAREHOUSE**  
MON • WED • FRI 10-6PM; TUES • THURS 10-8PM; SAT 10-5PM; SUN 1-5 (Dearborn Store Only)

**DEARBORN** 8425 N. TELEGRAPH (AT ANN ARBOR TRAIL) (313) 563-4460

**15th ANNIVERSARY SALE SINCE 1981**

**SAVE 10% TO 25% MORE**

On Like New Furniture and Decor Accessories That Are Priced Up To 70% Less When Compared To New

- Dining Room Sets • Bedroom Sets • Entertainment Cabinets • Wall Units
- Sofas • Easy Chairs • Tables • Lamps • Chandeliers • Oil Paintings
- Prints • Porcelain • China • Silver • Brass • Collectibles • And More

If it does not meet our high standards, it is not displayed in our showroom!

**Re-Sell-It ESTATE SALES**  
34769 GRAND RIVER FARMINGTON  
CALL 810 478-SELL DELIVERY AVAILABLE Serving You Since 1981

MAJOR CREDIT CARDS ACCEPTED  
HOURS 10 AM - 6 PM EVERYDAY SUNDAY 12 - 4 PM

**LIONEL**  
Amtrak passenger train set

Built to the rugged standards of historic Lionels, the Amtrak passenger set includes everything you need to get running: locomotive, three fully illuminated passenger cars, 27"x63" oval of track, and 40-watt power and control system. It's a terrific way to get into Lionel railroading—and it's a great value, too!

NOW ONLY **\$185**  
REG. \$219.95

**MERRI-SEVEN TRAINS & HOBBIES**  
19155 Merriman at 7 Mile • Livonia, MI 48152  
**(810) 477-0550**  
BUY • SELL • TRADE • REPAIR • ALL GAUGES  
Prices Good November 27 - December 7, 1996

**MOVADO**

**MOVADO VIZIO™**  
Solid stainless steel or steel/18K gold, with scratch-proof hard metal bezel  
Push-button deployable clasp  
Swiss quartz  
Sapphire crystal  
Water resistant  
Strap models, too  
Starting at \$995

**MC MASTERCRAFT JEWELERS**  
DESIGNERS • MANUFACTURERS • DIAMOND IMPORTERS  
LAUREL PARK PLACE  
6 Mile & I-275 • Livonia  
(313) 464-3555

**Rated #1 Nursing Facility in 7 Counties Oct. '96 by Detroit News and Free Press**

**Windemere**  
SUPPORTIVE CARE RESIDENCE

Treasured Moments... We Make Them Possible

Windemere offers diverse levels of care to accommodate the changing needs of older adults so Treasured Moments continue to be Living Moments

- Supportive Care
- Residential Assisted Living
- Respite
- Memory Impaired
- Skilled Nursing Care
- Medicare Certified
- Rehabilitation
- Physical
- Speech
- Occupational
- Home Health Care

**NO ENTRANCE FEES**

6950 FARMINGTON RD. WEST BLOOMFIELD (Just N. of 14 Mile Road)  
**810-661-1700**

**Windemere**  
Since 1981

1996 FESTIVAL OF TREES  
A Benefit for Children's Hospital of Michigan  
presents

**DREAMS CAN COME TRUE...**  
A NUTCRACKER CHRISTMAS  
November 24-December 1  
Cobo Center

**ADMISSION**  
Adults \$6, Seniors \$3 (60+), Children \$2 (12 and under)  
Children under 2 are free  
(Presale discounts available to groups of ten or more)

**ENJOY A MAGICAL HOLIDAY TRADITION AT THE 12th ANNUAL FESTIVAL OF TREES**  
Professionally Decorated Trees • Wreaths • Gingerbread Village  
Expanded Santaland with Activities for the Kids  
Teddy Bear Brunch (November 24 only)  
Daily Entertainment

**SHOW HOURS**

NOV 24 SUN	NOV 25 MON	NOV 26 TUE	NOV 27 WED
10-6	CLOSED	10-5	10-5
NOV 28 THU	NOV 29 FRI	NOV 30 SAT	DEC 1 SUN
10-3	10-8	10-8	10-6

**RAFFLE**  
1997 Jeep, Wrangler  
Jeep is a registered trademark of Chrysler Corporation

**SPONSORS**  
ENGLISH GARDENS NURSERY & GARDEN CENTER • MEIJER  
OGDEN ENTERTAINMENT • OLDIES 104.3 WOMC • PALMER MOVING & STORAGE

For information please call: 313-966-TREE  
Tickets available at English Gardens, Meijer and Cobo Center

**\$1.00 OFF ONE FULL PRICE ADULT ADMISSION WITH THIS AD**

Call GREEN SHEET CLASSIFIED (810) 348-3022

READ then RECYCLE

SHTN

# Thompson gets shot at prosecuting adult suspect

By TIM RICHARD  
Staff Writer

Oakland Prosecutor Richard Thompson got a going-away present from the Michigan Supreme Court — a chance to try Joseph D. Fultz, now in his mid-20s, as an adult for an alleged sexual assault committed when he was 15.

The highest court voted 5-2 to order Oakland Probate Judge Sandra Silver to waive jurisdiction over Fultz, binding him over to Circuit Court for trial as an adult.

If convicted as an adult, Fultz could get 4-10 years in prison. Had he been convicted when he was a juvenile, he could have been placed in a boys training home for a year. Judge Silver found that, even if he were found guilty, no facilities existed for someone in his mid-20s.

Thompson, who lost the Aug. 6 primary for renomination as prosecutor, had a tough reputation for appealing more judges' decisions than the other 82 prosecutors combined. And he appealed this one through the circuit, appeals and supreme courts.

Fultz was 15 and a niece in Holly was 7 in 1984 when two incidents were alleged to have occurred.

"We find the probate court abused its discretion in denying the prosecutor's motion to waive jurisdiction to the circuit court," said the half-page Supreme Court order. Concurring were Chief Justice James Brickley, Justices Dorothy Comstock Riley, Elizabeth Weaver, Patricia Boyle and Conrad Mallett Jr.

Silver was to issue the order binding Fultz over to circuit court last week, according to assistant prosecutor John S. Pallas. Fultz is free, at least until his arraignment.

Justice Charles Levin, retiring at the end of the year, filed one of the lengthy dissents for which he is noted — 10 pages — with Justice Michael Cavanagh concurring.

Fultz was 23 in 1991 when the girl brought the incidents to light. She said Fultz had handcuffed her a bedpost and forced her to have intercourse, forced her to perform fellatio and threatened her mother and sister if she told anyone.

Levin's dissent criticized the high court majority for issuing an order without an opinion that "thoughtfully, carefully, or adequately address(es) the issues."

"The defendant has in fact lived a life free of crime for eight years," Levin said. "There is thus no evidence that would justify a finding that he poses a threat to the public safety — one of the law's criteria."

Although the charge is serious, Levin said "the seriousness of the charge offense is but one criteria and may not alone be used to determine" whether Fultz is a danger to society.

Levin said the majority justices "usurp the probate judge's and jury's roles, as finders of fact, in deciding that the niece's allegations, rather than Fultz's denial, are to be believed in weighting as a factor the niece's assertion that she remained silent for over seven years because Fultz had threatened her."

Levin concluded: "The probate judge carefully and thoughtfully reviewed all the criteria. There was no abuse of discretion."

Silver took into account that Fultz was by then married with three children, had no criminal record and was unemployed but seeking work. She also considered that wife April Fultz testified her husband had never done anything inappropriate in their four years of marriage.

Pallas, arguing for the prosecutor's office, told the high court that under Silver's ruling, Fultz would "in effect have been immunized from criminal prosecution," and that the public welfare demands criminal prosecution.

"Can the juvenile offender escape punishment merely through the passage of time?" Pallas asked rhetorically. "You might just get away with it."

"Judge Silver is in essence blaming the victim for not coming forward earlier," Pallas told the justices, adding, "The prisons of this state are filled with convicts who are married and have children."

Since arguing the case two months ago, defense attorney Earl R. Spuhler of Fenton has joined the Genesee County prosecutor's office as an assistant prosecutor.

# ONE DAY ONLY!

**SATURDAY, NOV. 30, 1996**



# MAKE YOUR OWN SALE!

SAVE UP TO **\$55** on your total purchase\* when you use all ten Santa Bucks! (One Santa Buck per item)

**MEIJER**

<p><b>\$1 OFF</b></p> <p><b>SANTA BUCK</b></p> <p>with Santa Buck on any one regularly priced item in stock selling for 9.97 or more. Limit one item per Santa Buck. No additional Santa Bucks in store.</p> <p><b>MEIJER</b></p> <p>*Excludes alcoholic beverages, tobacco products, prescriptions, previous purchases, existing layaways and gas station. Good 6 a.m. thru midnight Sat., Nov. 30, 1996 only!</p>	<p><b>\$2 OFF</b></p> <p><b>SANTA BUCK</b></p> <p>with Santa Buck on any one regularly priced item in stock selling for 19.97 or more. Limit one item per Santa Buck. No additional Santa Bucks in store.</p> <p><b>MEIJER</b></p> <p>*Excludes alcoholic beverages, tobacco products, prescriptions, previous purchases, existing layaways and gas station. Good 6 a.m. thru midnight Sat., Nov. 30, 1996 only!</p>
<p><b>\$3 OFF</b></p> <p><b>SANTA BUCK</b></p> <p>with Santa Buck on any one regularly priced item in stock selling for 29.97 or more. Limit one item per Santa Buck. No additional Santa Bucks in store.</p> <p><b>MEIJER</b></p> <p>*Excludes alcoholic beverages, tobacco products, prescriptions, previous purchases, existing layaways and gas station. Good 6 a.m. thru midnight Sat., Nov. 30, 1996 only!</p>	<p><b>\$4 OFF</b></p> <p><b>SANTA BUCK</b></p> <p>with Santa Buck on any one regularly priced item in stock selling for 39.97 or more. Limit one item per Santa Buck. No additional Santa Bucks in store.</p> <p><b>MEIJER</b></p> <p>*Excludes alcoholic beverages, tobacco products, prescriptions, previous purchases, existing layaways and gas station. Good 6 a.m. thru midnight Sat., Nov. 30, 1996 only!</p>
<p><b>\$5 OFF</b></p> <p><b>SANTA BUCK</b></p> <p>with Santa Buck on any one regularly priced item in stock selling for 49.97 or more. Limit one item per Santa Buck. No additional Santa Bucks in store.</p> <p><b>MEIJER</b></p> <p>*Excludes alcoholic beverages, tobacco products, prescriptions, previous purchases, existing layaways and gas station. Good 6 a.m. thru midnight Sat., Nov. 30, 1996 only!</p>	<p><b>\$6 OFF</b></p> <p><b>SANTA BUCK</b></p> <p>with Santa Buck on any one regularly priced item in stock selling for 59.97 or more. Limit one item per Santa Buck. No additional Santa Bucks in store.</p> <p><b>MEIJER</b></p> <p>*Excludes alcoholic beverages, tobacco products, prescriptions, previous purchases, existing layaways and gas station. Good 6 a.m. thru midnight Sat., Nov. 30, 1996 only!</p>
<p><b>\$7 OFF</b></p> <p><b>SANTA BUCK</b></p> <p>with Santa Buck on any one regularly priced item in stock selling for 69.97 or more. Limit one item per Santa Buck. No additional Santa Bucks in store.</p> <p><b>MEIJER</b></p> <p>*Excludes alcoholic beverages, tobacco products, prescriptions, previous purchases, existing layaways and gas station. Good 6 a.m. thru midnight Sat., Nov. 30, 1996 only!</p>	<p><b>\$8 OFF</b></p> <p><b>SANTA BUCK</b></p> <p>with Santa Buck on any one regularly priced item in stock selling for 79.97 or more. Limit one item per Santa Buck. No additional Santa Bucks in store.</p> <p><b>MEIJER</b></p> <p>*Excludes alcoholic beverages, tobacco products, prescriptions, previous purchases, existing layaways and gas station. Good 6 a.m. thru midnight Sat., Nov. 30, 1996 only!</p>
<p><b>\$9 OFF</b></p> <p><b>SANTA BUCK</b></p> <p>with Santa Buck on any one regularly priced item in stock selling for 89.97 or more. Limit one item per Santa Buck. No additional Santa Bucks in store.</p> <p><b>MEIJER</b></p> <p>*Excludes alcoholic beverages, tobacco products, prescriptions, previous purchases, existing layaways and gas station. Good 6 a.m. thru midnight Sat., Nov. 30, 1996 only!</p>	<p><b>\$10 OFF</b></p> <p><b>SANTA BUCK</b></p> <p>with Santa Buck on any one regularly priced item in stock selling for 99.97 or more. Limit one item per Santa Buck. No additional Santa Bucks in store.</p> <p><b>MEIJER</b></p> <p>*Excludes alcoholic beverages, tobacco products, prescriptions, previous purchases, existing layaways and gas station. Good 6 a.m. thru midnight Sat., Nov. 30, 1996 only!</p>

**SATURDAY, NOV. 30, 1996**

# ONE DAY ONLY!

**40% Off ENTIRE STOCK**

**\*Winter Boots for the Whole Family**

Choose from a wide selection in the Shoe Department.

Styles and sizes may vary by store. \*Workboots, casual boots, sport boots and hikers not included. Everyday 8.97-64.95, sale 5.38-38.97.







# RECORD OUR TOWN

**B**  
THURSDAY  
November 28, 1996



Michael Haggerty, far left, of the Community Federal Credit Union, assists Amerman Elementary School student credit union bankers last Wednesday in completing a transaction. Tellers Layne Scherer, from left, and Aram Sarakisian help patrons Nickie Brants and Nika Frimanko.

## An Education To Bank On

Financial institutions team up with area elementary schools to give students a hands-on experience in money management

Story by **CAROL WORKENS**  
Photos by **JOHN HEIDER**



Novi Woods Elementary School student Cathleen Garbacik counts the deposits as part of her duties as head teller.

**A** penny saved is a penny earned.

Banking has never been easier. There are ATM machines in the lobby of or on the outside of banks if you can't make it to the bank during business hours. There are also small branches and ATMs in supermarkets and shopping malls.

Area elementary schools are also making it easy for students to save, as well as providing them with a good learning experience.

The Amerman Elementary School bank just opened for business on Nov. 21. Part of the Partnership in Education program, Community Federal Credit Union has been working with Amerman since 1991.

But this year there's a new twist - for the first time, the student bank is online with the Plymouth branch of the credit union.

To staff the bank, students filled out job application forms similar to those filled out by adults.

During the simplified interview process, students were evaluated on their ability to answer basic questions, and on their appearance, their demeanor and their ability to act professionally.

"They liked being in the spotlight," said Michael Haggerty, assistant vice president of the Northville branch of Community Federal Credit Union. "They were a little nervous but they liked it."

"They are learning some skills they can use when they go for their first interview."

The 35 fifth grade student staff members are not compensated, except for a big party at the end of the year.

"It is an excellent hands-on experience for them," said Jeff Lightfoot who has worked very closely with the students and the credit union.

There is also a group of students in the bank's marketing department who come up with ideas for publicity. Promotional ideas can consist of a video, a commercial,

continued on 3

### Volunteer



Photo by JOHN HEIDER

Harold Price is the food coordinator at Civic Concern.

## Price has the cost of food memorized

By **CAROL WORKENS**  
Staff Writer

Harold Price, a resident of Northville Township for 33 years, definitely knows his way around a store and where to shop the sales.

Price has been working with Northville's Civic Concern for about four or five years.

Civic Concern provides assistance for Novi and Northville needy families with food, rent, utilities and medical needs.

For the last two years, Price has been the food coordinator and is responsible for menus which list what foods are available.

Price and about four volunteers, and sometimes two to four high school students, will go to the old welding area at Northville High School where the food is stored, to pack the items into bags.

"The high school has been very cooperative," Price said. "They provide the room and provide us with the student help during the school year."

In the bags are vegetables, fruit, ravioli, cereal, pasta, spaghetti

sauce, peanut butter, jelly, soup and crackers, among other items.

"This is not the only support but it does provide quite a bit of food for them," Price said.

More unusual donated items, such as sardines, salmon, cream of broccoll or mushroom soup, and single items of a variety of foods, are not put in the bags but are set on the "goodie table" from which shoppers can choose.

"People should check their dates before they donate," Price said. Volunteers have to throw out any items which have expired dates.

After all the bags are packed, they are taken out to the volunteers' cars and hauled to the Northville Senior Center. Food is distributed twice a month, on the second and fourth Fridays, year round. A single person receives one bag of food, while a family of two or more receives two bags.

On a recent Friday, the volunteers gave out 75 bags of food and packed another 25 that went to Focus HOPE.

Continued on 5

### It's A Fact

#### WET BEHIND THE EARS

The Northville High School Mustangs swim team will



swim a total of 5,000 yards during a typical practice session.











Photo by JOHN HEIDER

The puppies held by Lorie DeGrazia, right, and vet assistant Colleen Porter, were adopted.

## Abandoned puppies adopted

By CAROL WORKENS  
Staff Writer

They were in a box but they weren't gift wrapped and they were not going to be placed under a Christmas tree.

Instead the brown cardboard box containing four 8-week-old female yellow Labrador mixed puppies was dumped off near Rocky's of Northville on Seven Mile Road in Northville Township.

The puppies were discovered by a neighbor of a client of veterinarian Carol Geake while she was walking her dog on Nov. 21.

The woman thought it was rather peculiar for the occupant to take a box out of the car, place it on the ground and drive away so she went over to take a look inside.

There are lots of options to dumping unwanted animals, according to Lorie DeGrazia, a veterinarian with Geake's clinic.

"You can often call veterinary clinics. A lot of times we can help people place them without actually

bringing them here."

People can call their vets to get local numbers for various organizations to contact. Organizations such as Friends for Animals, Animal Aid and the Humane Society will be glad to provide assistance.

"There are lots and lots of groups that can help," DeGrazia said.

It's lucky for the puppies that they were rescued in time. They could have been run over by a car or truck, they could have starved to death, or, at this time of year, they could have suffered from exposure and died.

"It is very cruel," DeGrazia said "It is not fair to them at all."

The puppies are in relatively good health, according to DeGrazia, and have now been wormed and given their first shots.

This story has a happy ending, though. As of Monday, all four had been adopted.

"We do know of some dogs and cats who are being fostered out right now that need homes," DeGrazia said.

For more information on other dogs or cats that need homes, call 349-2598.

### Reunions

**ST. DAMIAN'S GRADE SCHOOL:** Eighth grade graduates and all teachers, classes of 1964-1986, Nov. 29. Registration begins at 4:30 p.m. in St. Damian's Community Room, 29825 Joy Road, Westland, Mass. Is at 5 p.m. A school tour and a dinner/dance is at 7 p.m. at Laurel Manor in Livonia. Call (313) 397-3158.

**NOVI HIGH SCHOOL:** Class of 1986, 10 year reunion, Nov. 30, Holiday Inn, Farmington Hills. Call (810) 360-7004.

**DEARBORN HIGH SCHOOL:** Class of 1986, 10 year reunion, Nov. 29, at Hawthorne Valley in Westland. Call (810) 360-7004.

**FERNDALE HIGH SCHOOL:** Class of 1971, 25-year reunion on Nov. 30 at DoubleTree in Southfield. Call (810) 360-7004.

**STERLING HEIGHTS HIGH SCHOOL:** Class of 1986, Nov. 29, Sterling Inn in Sterling Heights. Call (313) 886-0770.

**WARREN MOTT HIGH SCHOOL:** Class of 1986, Nov. 29, Barrister House, St. Clair Shores. Call (313) 886-0770.

**STERLING HEIGHTS STEVENSON HIGH SCHOOL:** Class of 1971, Nov. 29, Sterling Inn, Sterling Heights. Call (313) 886-0770.

**LINCOLN PARK HIGH SCHOOL:** Class of 1976, Nov. 29, Ramada Heritage in Southgate. Call (313) 886-0770.

**BERKLEY HIGH SCHOOL:** Class of 1971, Nov. 30, Kingsley Inn, Bloomfield Hills. Call (313) 886-0770.

**REDFORD UNION HIGH SCHOOL:** Class of 1981, Nov. 30, Vladimir's Hall, Farmington. Call (313) 886-0770.

### Engagement



James Hazlett III/Wendy Kohl

James and Judith Kohl of Northville announce the engagement of their daughter, Wendy Elizabeth, to James Cummins Hazlett III, son of Drs. James and Linda Hazlett of Grosse Pointe, Mich.

The bride-elect graduated from Northville High School in 1989, and received her degree in 1993 from Michigan State University. She is in her third year of teaching fourth grade in the Clarenceville

School District. The bridegroom-elect is a 1988 graduate of University Liggett High School. He graduated from Michigan State University in 1992, with a bachelor's degree in science. He currently attends dental school at the University of Michigan and will graduate in May 1997. Upon graduation from U-M, he will enter the U.S. Air Force to do his residency in advanced dentistry. A December wedding is planned.

For Quick Results  
Call GREEN SHEET (810) 348-3022  
CLASSIFIED

## Program helps the needy

Continued from 1

Old Village School has two boys who volunteer to help carry bags on distribution days.

"We have quite a unique operation," Price said.

Price recently went to pick up 35 heads of lettuce and 35 pounds of apples which a frequent contributor to Civic Concern had recently bought.

Price buys food at very responsible prices at the Oakland County Food Bank through government and Skillman Foundation grants.

With the help of a truck and a driver who volunteers four times a year, Price can pick up 4,000 to 5,000 pounds of food at a time. Last year, Civic Concern collected 9,000 pounds of food. Price also takes advantage of sales at area stores.

Food donations come from area churches such as Our Lady of Victory Church, St. Paul's Lutheran Church, First United Methodist Church in Northville and the First Presbyterian Church in Northville. All the area churches help with monetary contributions when needed.

So far this year Cooke Middle School has held a paper drive and collected Kleenex, toilet paper and paper towels, while Meads Mill Middle School held a food drive. Ninety rolls of toilet paper were given out on Friday.

Besides food donations, Civic Concern is also in need of monetary donations, which are tax deductible.

Northville's Kiwanis and Moose lodges are among the many monetary contributors.

"We get it from all over the community," said Price.

Many area businesses adopt a family for Christmas. Civic Concern receives the proceeds from the Goodfellows paper drive, and from the Common Folk dinner which was held at Genitt's Hole-in-the-Wall restaurant.

Civic Concern has also been the beneficiary of the food collection of both the Northville and Novi post offices for the last few years. Residents put food out in their mail boxes which the mail carrier collects.

"In addition to food we help people with rent and utility payments and medical needs," Price said.

The headquarters for Civic Concern is at Cooke Middle School, 21200 Taft Road. For more information, call 344-1033.



# Marketplace

## We bring a lot to the party!







**We carry a variety of high quality ready-to-serve appetizers and hors d'oeuvres, entrées and side dishes, scrumptious desserts, and tabletop supplies from paper plates and cups to punch bowls and cater trays all designed to save you time and money during your busy holiday season.**

**PUBLIC WELCOME • NO MEMBERSHIP FEE**

**10 Detroit Locations to Serve You!**

Brighton (810) 220-0110	Farmington Hills (810) 474-1990	Mt Clemens (810) 792-7600	Rochester Hills (810) 656-6000
Taylor (313) 291-0360	Troy (810) 588-1700	Utica (810) 254-5656	Warren (810) 983-5405
	Westland (313) 721-8700	Wixom (810) 926-0353	

Stop in and see our selection of holiday gift items!



Mon. - Sat.: 8 - 8  
Sun.: 12 - 5





# RECORD MOVIES

**7B**  
THURSDAY  
November 28, 1996

## 'Looking For Richard' translates Shakespeare's gripping drama

For the first time in his lengthy career, Al Pacino dons three hats as creator, director and star of "Looking for Richard." In the vein of Truffaut's "Day for Night" or Fellini's "8 1/2", Pacino's impassioned project intertwines the telling of "Richard III" — Shakespeare's gripping drama of power, lust and betrayal — with an intimate look at the actors' and filmmakers' processes as they grapple with their characterizations and with translating their enthusiasm for the play on to film.

Pacino takes the cameras on a free-spirited comic romp through the streets of New York to the birthplace of Shakespeare, and finally, to an emotionally-charged production of "Richard III."

The opportunity to present Shakespeare in an untraditional format and make it as accessible as possible for a modern audience charmed a dedicated and benevolent cast including Estelle Parsons as Queen Margot, Alec Baldwin as Clarence, Kevin Spacey as Buckingham, Winona Ryder as Lady Anne and Aidan Quinn as Richmond.

With contagious enthusiasm and the assistance of such respected actors as Sir John Gielgud, Sir Derek Jacobi, Kenneth Branagh, Vanessa Redgrave, James Earl Jones and Kevin Kline, Pacino seeks to prove that everyone can enjoy Shakespeare, and that his tales are timeless in their exploration of human nature.

While throwing themselves into their characters, Pacino and his actors had to break down centuries of barriers surrounding one of Shakespeare's most complicated and intimidating works. "You don't need to understand every single word that's said, as long as you get the gist of what's going on. Just trust it and you'll get it," says Pacino.

In defiance of tradition, the viewer is allowed to go behind the scenes and witness the actual process of acting. The weightier aspects of "Richard III" are leveled by informal shots of the actors digging their teeth into their roles in an often comic and sometimes heated forum.

Pacino's methods of analysis are insightful, amusing and engrossing. As he stands in London's legendary Globe Theatre and in the



Al Pacino is star, director and creator of "Looking For Richard," a Fox Searchlight release.

austere halls of New York City's Cloisters Museum, Pacino transcends the barrier between actors and their audience.

His devoted pantheon of performers evidently had their own heartfelt enthusiasm for the project. "Some of these actors returned the checks we gave them and told us to put the money into the film instead."

While "Looking for Richard" journeys with the actors both in and out of character, following their struggles, debates and revelations about the play, Pacino also takes to the streets of New York to measure public opinion about Richard III.

Pacino's wild energy receives a range of responses from "Richard who?" to opinionated preaching on Shakespeare, as one street person proclaims: "He helped us and instructed us in the art of feeling."

Pacino notes, "By juxtaposing the day-to-day life of the actors and their characters with ordinary people, we attempted to create a comic mosaic — a very different Shakespeare. Our main goal with this project is to reach an audience that would not normally participate in this kind of language and world."

## Send your reviews

Become a movie critic in your local newspaper by sending your mini movie review (200 words or less) to Home-Town Newspapers, C/O Katie Bach, 323 E. Grand River

Avenue, Howell MI 48843. Or e-mail a review to pjerome@htonline.com. For more information on the movie page, call Katie at 517-548-2000.

## "FIRST CONTACT" IS THE 'ID4' FOR THE HOLIDAYS!"

"PURE ADRENALINE AND FULL-BLAST ENTERTAINMENT!"

"A WILD RIDE OF ACTION AND HUMOR. The best thrill of the 'Star Trek' film series." — New York, KANSAS CITY SUN

"FIRST CONTACT STANDS PROUD AND APART. Glides along with purpose and style." — Richard Corliss, TIME

"BOLDLY GOES WHERE NO 'STAR TREK' HAS GONE BEFORE. New action-packed heights." — John Lasker, NEWS CHANNEL 8

"A GREAT ACTION FILM." — Ed Diemer, TUNE-IN PUBLICATIONS

"THE SPECIAL EFFECTS ARE ABSOLUTELY ASTOUNDING. It has all the suspense of 'Aliens' wrapped up in a nice 'Star Trek' package. You don't have to be a Trekker to enjoy." — Jerry Perone, GREAT MAGAZINE



AMC AMERICANA WEST	NOW SHOWING	AMC BEL AIR 10
AMC EASTLAND 5	AMC SOUTHFIELD CITY	AMC LAUREL PARK
BIRMINGHAM 8	GENERAL CINEMAS CANTON	RENAISSANCE 4
SHOWCASE AUBURN HILLS	SHOWCASE PONTIAC	SHOWCASE STERLING HEIGHTS
SHOWCASE WESTLAND	STAR GRATIOT AT 15 MILE	STAR JOHN R. AT 14 MILE
STAR LINCOLN PARK 8	STAR ROCHESTER HILLS	STAR TAYLOR
UNITED ARTISTS FAIRLANE	UNITED ARTISTS LAKESIDE	UNITED ARTISTS 12 OAKS
UNITED ARTISTS WEST RIVER	FORD WYOMING	NO PASSES OR COUPONS ACCEPTED

## "THE BEST FILM OF 1996!"



"TWO THUMBS UP!" — Siskel & Ebert  
"SPELLBINDING!" — Janet Maslin, THE NEW YORK TIMES  
**MEL GIBSON**  
**RANSOM**

AMC ABBEY 8	AMC AMERICANA WEST	AMC BEL AIR 10
AMC LAUREL PARK	AMC SOUTHFIELD CITY	AMC STERLING CTR. 10
AMC WOODS 6	BIRMINGHAM 8	GENERAL CINEMAS CANTON
SHOWCASE AUBURN HILLS	SHOWCASE DEARBORN	SHOWCASE PONTIAC
SHOWCASE STERLING HEIGHTS	SHOWCASE WESTLAND	STAR GRATIOT AT 15 MILE
STAR LINCOLN PARK 8	STAR ROCHESTER HILLS	STAR TAYLOR
UNITED ARTISTS 12 OAKS	UNITED ARTISTS WEST RIVER	WYANDOTTE

## "THE ENGLISH PATIENT IS ONE FOR THE AGES!"

Of some 6,000 films I've seen over my 28 years as a professional viewer, *The English Patient* is the best of all.

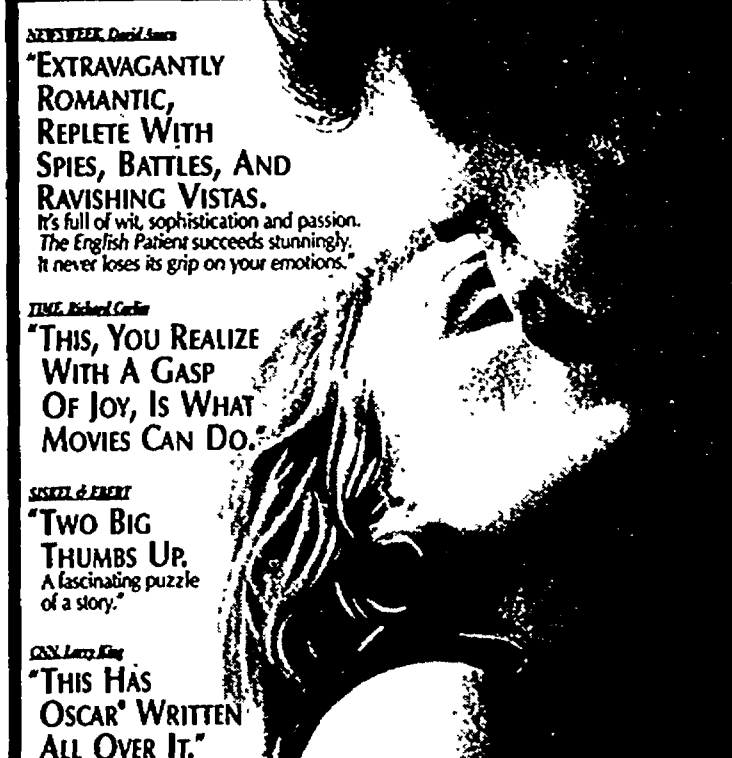

**THE ENGLISH PATIENT**

NOW SHOWING	AMC LAUREL PARK	AMC MAPLE	AMC WOODS
BIRMINGHAM 8	MAIN ART THEATRE	SHOWCASE PONTIAC 6-12	SHOWCASE WESTLAND
STAR GRATIOT	STAR JOHN R.	STAR ROCHESTER	UNITED ARTISTS 12 OAKS

## "DISNEY MAGIC HAS DONE IT AGAIN!!"

"A CLASSIC MASTERPIECE! FANTASTIC, INCREDIBLE!"



AMC BEL AIR 10	AMC EASTLAND	AMC AMERICANA WEST
AMC SOUTHFIELD CITY	AMC SOUTHLAND	AMC LAUREL PARK
BIRMINGHAM 8	GENERAL CINEMAS CANTON	AMC WONDERLAND
SHOWCASE DEARBORN	SHOWCASE PONTIAC	SHOWCASE AUBURN HILLS
SHOWCASE WESTLAND	STAR GRATIOT AT 15 MILE	SHOWCASE STERLING HIGHTS
STAR LINCOLN PARK 8	STAR WINCHESTER 8	STAR JOHN R. AT 14 MILE
UNITED ARTISTS WEST RIVER	WYANDOTTE	UNITED ARTISTS LAKESIDE

## Make It a Family Tradition

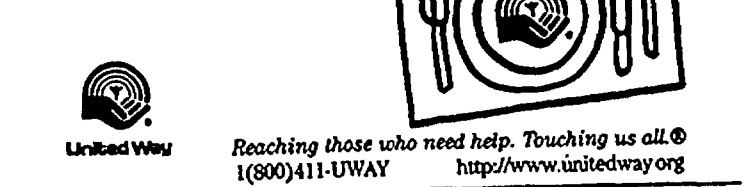

## THIS THANKSGIVING WEEKEND SAVE ROOM FOR "THIS HOLIDAY SEASON'S BEST MOVIE."

"ARNOLD AND SINBAD ARE HILARIOUS... A COMEDY THE ENTIRE FAMILY CAN ENJOY."

"SIDE-SPLITTING. THE BEST HOLIDAY FAMILY FILM IN YEARS."

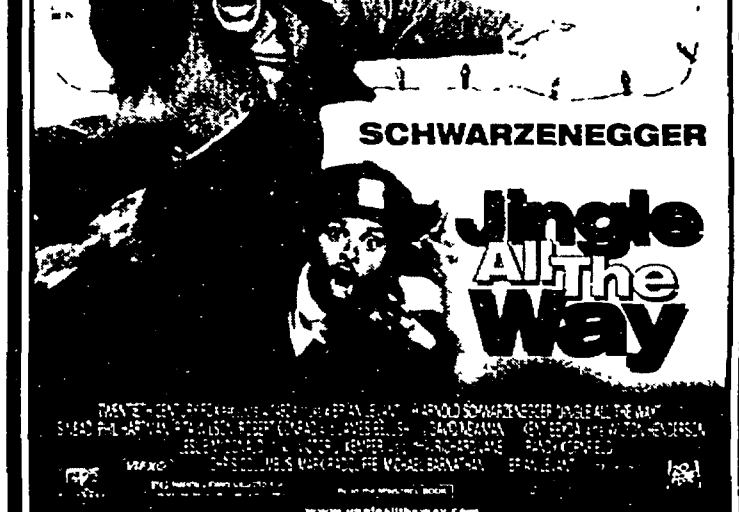

## NOW SHOWING

AMC AMERICANA WEST	AMC BEL AIR	AMC EASTLAND 5
AMC LAUREL PARK	AMC SOUTHFIELD	AMC WONDERLAND
BIRMINGHAM 8	GCC NOV TOWN CTR.	QUO VADIS
SHOWCASE AUBURN HILLS	SHOWCASE PONTIAC 1-5	SHOWCASE STERLING HIGHTS
STAR GRATIOT	STAR LINCOLN PARK	STAR TAYLOR
STAR WINCHESTER	UNITED ARTISTS FAIRLANE	UNITED ARTISTS LAKESIDE MALL
UNITED ARTISTS OAKLAND MALL	UNITED ARTISTS WEST RIVER	SORRY NO PASSES DURING ENGAGEMENT

READ then RECYCLE















**REAL ESTATE**

**When title companies, Realtors cross the line**

By **Jame M. Woodard**  
Copley News Service

Title companies and Realtor firms usually work well together as a business team, helping consumers purchase homes and other real estate. But sometimes they get too close.

Some title companies are providing services, materials and even cash to real estate brokers who send business their way. This falls into the area of illegal "kickbacks," and regulatory agencies are cracking down on violating firms.

"We're now investigating the practices of five title companies," said Dennis Ward, chief of enforcement for the California Department of Insurance. He declined to identify the firms while the investigations are under way.

California probably leads the country in the number of recent violations, but the problem is nationwide.

"We plan to conduct in-depth examinations of 15 to 20 firms by

the end of this fiscal year, next June," Ward said.

The most common practice being targeted in current investigations is the printing and distribution of promotional property flyers or brochures. In some cases, this service is provided free by title companies for "good customer" Realtors or their sales associates.

Other questionable practices are providing computers, software packages, cellular phones, fax machines and other equipment for Realtor firms.

In some cases, a full-time escrow coordinator - an employee of the title company - is headquartered in a Realtor's office. The title company pays rent for the coordinator's office space, sometimes a far greater rent than the space is really worth, Ward said.

Many of these practices have become widespread in the real estate and title industries and need to be controlled, he noted.

Continued on 2

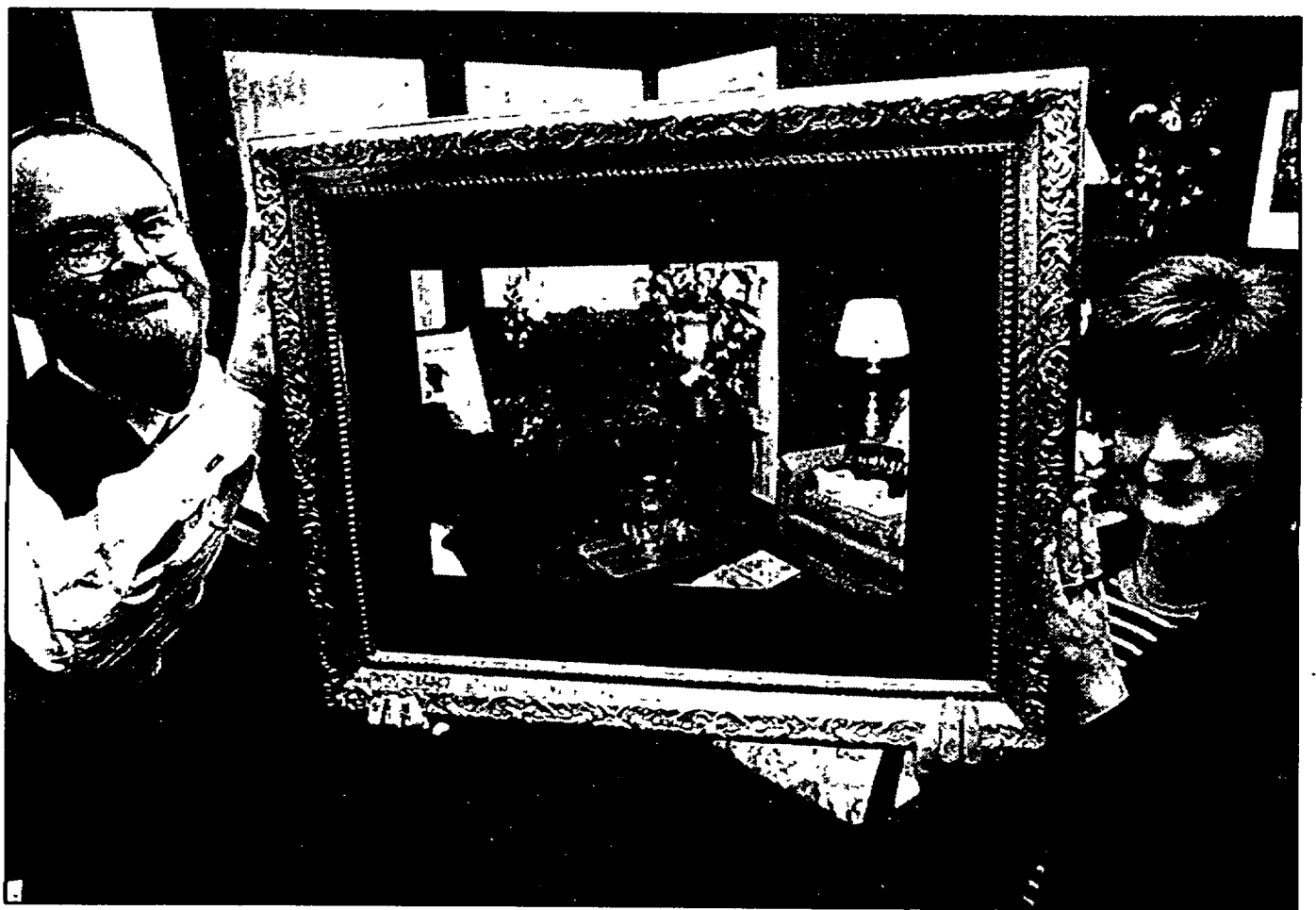

Tom Lynch helps wife Mary Tata put the final touches on her first "Cottage Sale" at their home in Milford.

**HOME DESIGNS**



**The Arie is uniquely suited for weekend travelers**

By **James McAlexander**  
Copley News Service

For weekend travelers concerned about finding a safe place to park their recreational vehicle when they return home, the impressive Arie will put an end to those worries. A full-sized R.V. storage unit has been designed to fit alongside the garage of this 2,171-square-foot charmer. When you return from a trip, whether it lasts a few days or a few weeks, you'll be happy to have this beautiful house waiting.

A wrap-around porch with waist-high railing adds a homey touch to the exterior design. If the weather turns chilly, warm up by spending some time in the spa that's located in the glass-enclosed green room.

The interior motif also will lift your spirits. There is plenty of room here for entertaining friends in comfortable surroundings. Near the recessed entry, the vaulted living room serves as a cozy retreat. Warmed by a wood stove, this is the perfect spot for rejoicing in good conversation or savoring the view through the huge bay window.

Meals are to be appreciated in the Arie. The formal dining room boasts French doors that open to the porch, allowing a cool breeze to

grace your dinner table. For more informal eating, a breakfast nook and eating bar are on either side of the walk-through kitchen, in addition to all the built-in appliances, there is a roomy walk-in pantry.

The isolated master suite features personal access to both the greenroom/spa and a back deck that runs the length of the building. Other master suite amenities include a walk-in closet and private bathroom.

The second bedroom, which also is isolated for privacy, will function well as quarters for overnight guests or an elderly parent that is part of the household. A full bathroom is close by.

Separating the two bedrooms, the large family room is the main gathering point in the Arie. Lots of space here to set up a pool table, or a couple of couches and a big-screen television.

When the sun is shining, put the barbecue out on the back deck.

For a study plan of the Arie (403-03), send \$10 to Landmark Designs, c/o HomeTown Newspapers, 323 E. Grand River, Howell, MI 48843. (Be sure to specify plan name and number when ordering.) For more information, call (800) 562-1151.

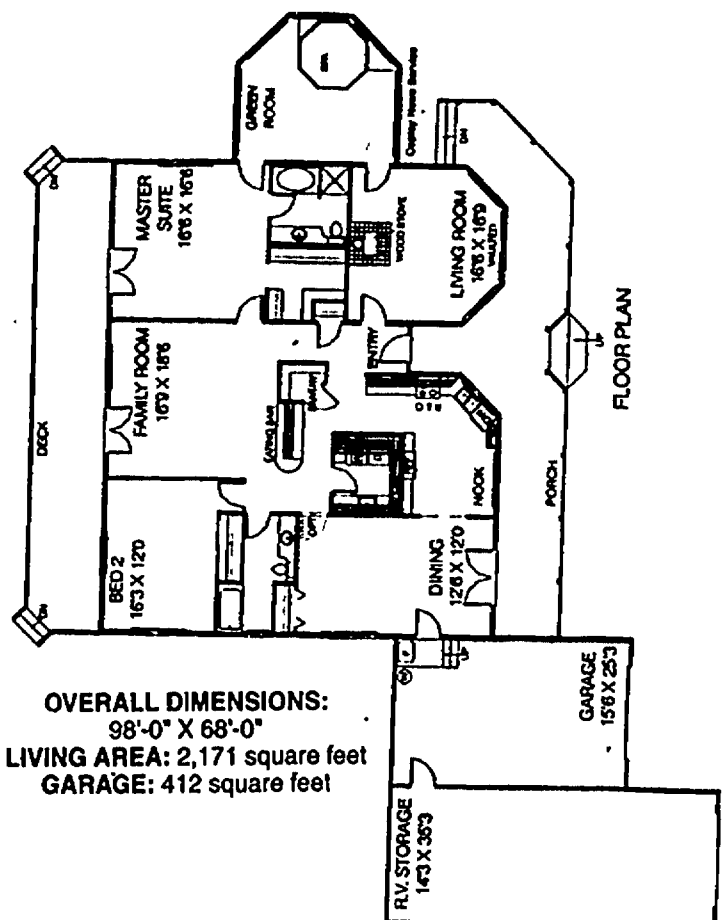

**Welcome to Mary's Cottage**

Mary Tata says there is no such thing as a cottage sale. You won't find it in the dictionary, and she's never been to one. But that didn't stop her from dreaming one up.

"I got the idea from the cottage industries, when people used to make things with their hands and sell them. Then, my sister got me this great stationery with a cottage on it," Tata said.

Fate took over to produce the first cottage sale in the Milford area. Just like the art she produces, the wife of author and funeral director Tom Lynch likes to pioneer new territory.

So what in the world is a cottage sale, anyway? It's her eclectic collection of something for everyone; including antiques, floral arrangements, rustic furniture, interesting craft and retail items. It might be a special bow, or hand-painting that makes you want to take something home.

Nothing is ordinary here. The items for sale are as varied as this lady's talent. Some are original art objects, like the sculptures and some hand-sewn items.

Two unique scarves are an example. One is an off-white Victorian silk number with golden charms sewn onto the hem of the scarf as fringe. A small pocket is sewn into the inside of the scarf to carry necessities.

The second scarf was inspired by her fisherman

Other artists who contributed to Mary Tata's Cottage Sale include:  
**Fammy Gwile**: Native American Dream Catchers.  
**Penny Pfeil**: Grown-up dress up clothes for young girls.  
**Sher Toburen**: Hand-stamped and embossed cards and stationery. (Toburen also gave demonstrations during the sale.)

husband. It's a deep purple adorned with fishing tackle, weights and lures as fringe.

Although the Nov. 9 sale wasn't open to the public, about 75 special invitations were sent out. Many Liberty Street neighbors were included, as well as friends and relatives. This prompted an

added bonus — reasonable prices on her items.

Guests wandered through the layout of Tata's and Lynch's exquisitely decorated home and snacked on cider

and desserts. Many shoppers arrived promptly at the start of the sale to get the best selections.

The rooms were organized by themes. The kitchen/dining room contained some of the children's toys and items. A throwback to the childhood days of yesteryear, cigar boxes were filled with collectibles like marbles, match-box cars and pencils. One box was filled with art supplies, including colored pencils and markers. The dining area held many of the jewelry items, and the formal dining room contained the art objects.

Some of Tata's favorite items are the baskets she creates; mixing the old with the new, and combining interest-

Continued on 2

Story by **Annette Jaworski** • Photo by **Scott Benedict**

**Majestic mums take work**

By **C.Z. Guest**  
Copley News Service

**GARDENING**

The fall flowering time of the garden mum is nature's grandest show.

To reap the greatest satisfaction for yourself and your garden mums, there are a few simple tasks that need to be accomplished, not just in the fall but all year.

The first thing to remember is to get the root system of your plants established before winter sets in. Generally, garden mums purchased in pots will have a more consistent root system than those dug from the garden. The garden-grown plants will require slightly more care, and the most important ingredient for success is water.

With the coming of fall, we all naturally start paying less attention to our gardens. In many areas where September and October can be dry months, this is a terrible mistake. You must keep newly planted garden mums or any other plantings from drying out until the ground freezes.

Some care and handling tips:  
 Plant garden mums in a

sunny spot where they can get at least a half-day's sun. Plant in fertile, well-drained soil. Soil can be improved upon by adding compost, peat moss or other organic matter. Garden mums planted outdoors in the fall do not need to be fertilized until they begin to grow the following spring. There is also no need to prune back plants until spring.

Mulch plants after several hard frosts with straw hay or evergreen branches.

In the spring, remove any old plant stems (a rake works perfectly) and gradually remove the mulch as the season warms up.

During the growing season, liquid or dry fertilizers may be used; read instructions carefully - this is the key to vigorous growth. Continue to fertilize until August or until buds begin to show color.

To encourage branching and development of compact plants, begin pinching by using your thumbnail and index finger as soon as

Continued on 2

**Maintenance for mums**

Beautiful fall mums require a minimal amount of work year-round. Watering and fertilizing top the list.

- Plant mums in fertile, well-drained soil. Spot must be sunny.
- Use compost, peat moss or other organic matter to enrich soil.
- Fertilize only during the growing season of spring and early summer. Do not fertilize once buds appear.
- Do not prune during winter.
- Mulch with straw, hay or evergreen branches after a few

- hard frosts. Take the mulch off in the spring and remove dead plant stems from mums.
- Keep mums compact by pinching off new growth. Pinch growth back once a new stem reaches 3 to 5 inches in length. Do not pinch new growth after July 15 in the North or Aug. 1 in the South.



Copley News Service/Dan Clifford















Open the door to your dream! Classified is your best location for information about new homes and apartments. Check it out today!

Howell 517-548-2570  
South Lyon 810-437-4133  
Northville/Novi 810-348-3022



Brighton 810-227-4436  
Milford 810-685-8705

# MAKIN' IT HAPPEN

1998 GREENSHEET EAST/CREATIVE/11/27/98

**414 Rooms**

**MILFORD LARGE** furnished room, facing Kensington Park, kitchen, & laundry privileges. References & security deposit \$300 mo. (810)685-2774.

**SOUTH LYON** \$75 per week, utilities included. Full house privileges. (810)486-2664

**SOUTH LYON** Deluxe rooms. Low weekly/daily rates. TV, maid service. Country Meadow Inn, Pontiac Trail, (810)437-4421.

**STOCKBRIDGE/GREGORY, ELDERLY** - Family has room for 1 ambulatory elderly person to come and be a family with us. (517)851-4600 after 6pm

**422 Office Space**

**BRIGHTON** - 100 & 200 sq ft. of office space available. Very reasonable. (810)227-3188.

**BRIGHTON** - Near downtown. Grand River frontage. \$280/mo. (810)227-2201.

**BRIGHTON CITY** Professional air cond. office space w/conference room & adjoining office. From \$180-\$2000/mo. Immediate occupancy Call Karl (810)229-2459

**BRIGHTON FREE** Rent. Affordable, expressway accessible office space. Private parking & amenities. 300 to 4,000 sq ft. units. (810)229-6446.

**BRIGHTON OFFICE** space for rent. Approximately 1000sq. ft. divided. 603 W. Grand River, Cal. (810)229-6323 and ask for Mike or Bernie.

**BRIGHTON, NEAR** downtown. \$104 per mo. (810) 227-2201.

**HOWELL** - Prime Byron Rd. location across from Hospital. 760sq ft. \$15/sq.ft./yr. Call Dr. Michael Kerr. (517) 546-3065

**NOVL 125-SQ.FT.** unfurnished interior office for rent. Secretarial services available. (810)344-0098.

**RETAIL OR** office space available. 1,200 sq ft. Hamlet Plaza, Novi Rd., between 8 & 9 Mile (810)349-8120 ask for Greg

**BRIGHTON-WAREHOUSE** space, air conditioned, overhead door, 1200 sq ft. \$650/mo. Office/Warehouse space also available. (810)229-2469

**FOWLERYVILLE** Commercial property Downtown for rent. 800sq ft. Storage only. 3300sq ft. retail/light industrial. 2,800sq ft. retail office. plenty of parking Call Teri Best, (810)227-1761.

**GREEN OAK Twp.** 6200sq. ft. industrial building for lease. Deluxe offices, dock, overhead door, 28ft ceiling. 1200ft. from 23 Hwy. 20th Century Realty. (810)231-3300.

**MILFORD. WAREHOUSE** or light industrial space for rent. All sizes. 500 to 15,000sq.ft. Perfect for contractors or small businesses. (810)685-0291

**NOVL 14,100SQ.FT.** warehouse w/loading docks. 1801sq.ft. of office. I-96 & Beck Rd Call (810)348-8864.

**REMODELED DOWNTOWN** Milford store. Ideal for retail or office. Approx. 2,000sq ft. Exc. location. (810)685-2364

**THORNTON MINI STORAGE** now has outside storage. 1574 Alloy Pkwy., Highland. (810)887-1132.

**WHITE LAKE** - inside/outside, secure, reasonable rates, boats, cars, etc. (810)887-2767

**440 Wanted To Rent**

ALL ADS TO APPEAR UNDER THIS CLASSIFICATION MUST BE PREPAID

**457 Property Management**

SINGLE FAMILY HOME LEASING AND MANAGEMENT FOR ABSENTEE OWNERS MeadowManagement, Inc. Novi AMO. Serving Livingston & Sylv. Oakland Counties (810)348-5400

CLEAR OUT your garage or attic and make some extra cash at it. Advertise a garage sale in our classified ads

GREEN SHEET ads get results.

**Find Yourself...In the Navy.**

**You'll Find:**

- Equal Access to Success
- 60,000 Jobs Open Right Now!



**Join an Exciting Team! NAVY**

For more information, call 1-800-USA-NAVY.  
World Wide Web: <http://www.navyjobs.com>

# Who Can Solve This Problem?

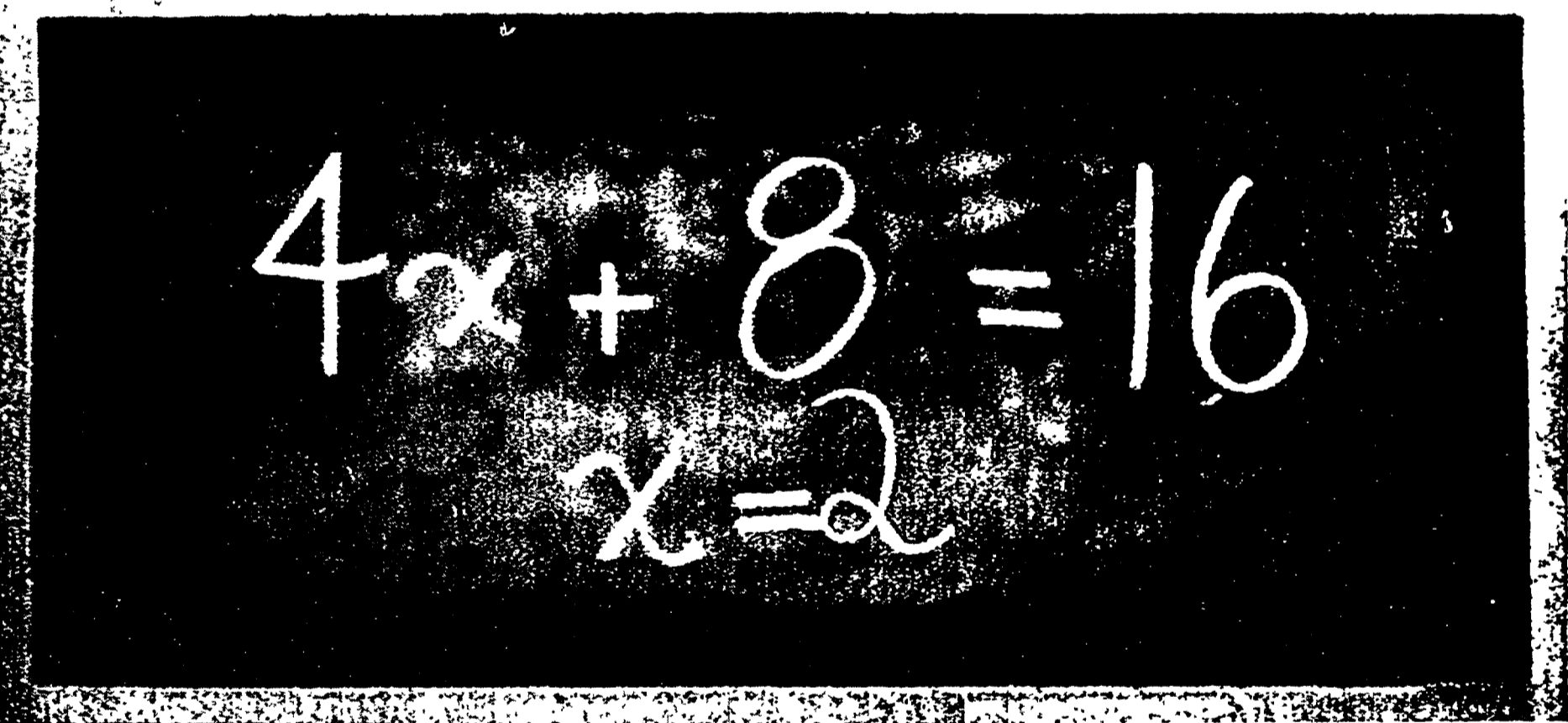

Right now, in some school districts, third graders are learning how to solve this equation. And in some school districts, sixth graders are learning. But there are still some school districts where seniors will receive a diploma, without ever having to face the question.

**Insist on higher academic standards in your school district.**



AMERICAN FEDERATION OF TEACHERS EDUCATIONAL FOUNDATION

## Quantity and quality in stock at food store

By SCOTT DANIEL  
Staff Writer

If you're like everyone else, grocery shopping comes in at about 97th on your list of things to do.

Let's see. There's the kids' soccer game, dry cleaning to pick up, friends to visit, housework to do ... the list goes on and on.

So instead of visiting the local superstore at midnight, why not get your grocery shopping done for, say, the next month?

At Gordon Food Service in Wixom, you can do just that. The store, which opened in mid-October, allows customers to buy both quantity and quality at a reasonable price.

Manager Gerry Ward said about 75 percent of his store's business thus far is from local homeowners. Gordon Food Service also has many corporate clients, he remarked.

"We cater to most smaller restaurants and grocery stores," Ward said. "A lot of school districts come to supplement their (food) orders."

Gordon Food Service has been one of the leading suppliers of food service products in Michigan for more than 50 years. The company serviced corporate clients and school districts exclusively until opening its "Marketplace" stores in 1970.

Since then, 54 Gordon Food Service Marketplace stores have opened around the state.

Ward said the company decided to open a 14,000 square foot facility in Wixom to meet increasing demand in the area.

"A lot of people were already familiar with us because of our

Brighton and Farmington Hills stores," he added.

Located just off Wixom Road between I-96 and Pontiac Trail at 49200 Wixom Tech Drive, the store offers a variety of food and other products.

A huge selection of frozen foods is available. Everything from vegetables, to deserts and pizza are on hand.

Then there's can goods. Again, an assortment of vegetables can be found as well as soups and condiments.

But take note: you won't find too many single serving containers. If you like corn, for example, your average GFS container holds several pounds of kernels.

Fresh produce, meats and dairy products can fill immediate needs if bulk buying isn't your preference.

Ward said an advantage of shopping at Gordon is quality of its grocery items.

"We offer restaurant quality products," he said.

Party supplies and paper products also come in larger quantities. Table top items, table covers and utensils are just a few of the other products available.

Unlike many of the warehouse clubs, there's no membership fee at Gordon Food Service.

"There's no cost difference to buy off the shelf," said Ward.

The store also offers 5 percent discounts for many types of business organizations, including churches.

Gordon Food Service is open Monday through Saturday 8 a.m. to 8 p.m. and on Sunday from noon to 5 p.m. For more information, call (810) 926-0353.



Photo by JOHN HEIDER

Gordon Food Service store manager Gerry Ward displays some of the shop's canned goods. GFS, which opened Oct. 16, specializes in food and kitchen necessities.

### You're Invited To Our 5th Annual WINTER OPEN HOUSE

FRIDAY & SATURDAY, NOVEMBER 29 & 30

9 AM TIL 6 PM

UP TO 60% OFF PARTS & ACCESSORIES

- Oil
- Helmets
- Suits
- Duffle Bags
- Woodys Ice Studs
- Gloves
- Sweat Shirts
- Toys
- Hats

And Much More!

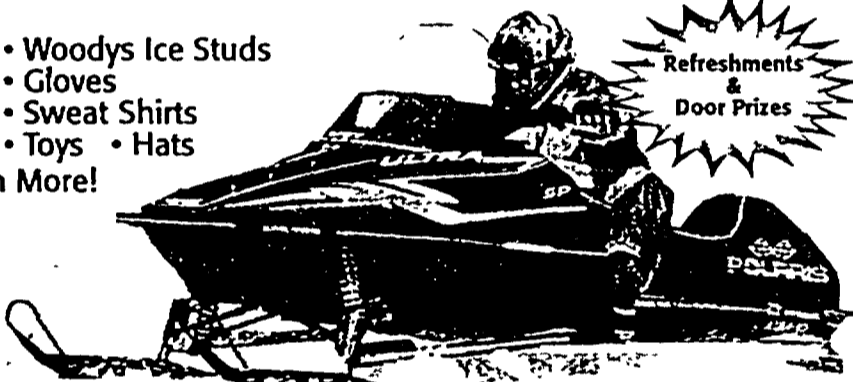

Come See  
Daytona Race Bike  
on Display  
Sat. Nov. 30th  
- Also -  
The Top Drag Sleds  
And Drivers

Talk with the Factory Reps From:

**ARCTIC CAT POLARIS YAMAHA**

**BAKER'S LAWN & LEISURE**

1155 Milford Rd., Highland (810) 887-2410

M-59

MILFORD RD. 1/2 MILE S. OF M-59

VISA M-C

### Santa's not the only one who needs a Deere this winter.



Nothing Runs Like a Deere®

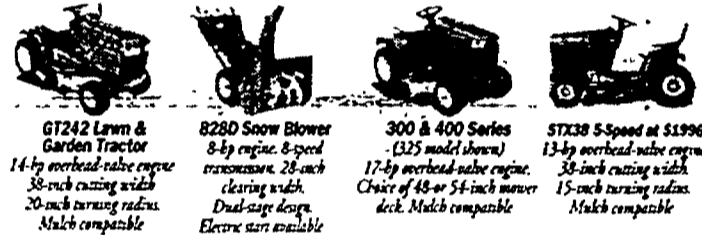

GT242 Lawn & Garden Tractor  
14-hp overhead-valve engine  
38-inch cutting width  
20-inch turning radius  
Match compatible

B280 Snow Blower  
8-hp engine, 8-speed transmission, 28-inch clearing width  
Dual-stage design  
Electric start available

300 & 400 Series  
(325 model shown)  
17-hp overhead-valve engine  
Clear of 48-or 54-inch mower deck. Match compatible

STX38 5-Speed at \$1996  
13-hp overhead-valve engine  
38-inch cutting width  
15-inch turning radius  
Match compatible

**\$97 DOWN** If you've been waiting for the perfect time to buy John Deere equipment, it's here. That's because right now you can take home one of our featured lawn tractors or snow blowers for only \$97 down\* with no interest and no payments until April 1, 1997. Offer ends December 31, 1996. \*Tis the season for a great offer.

**BAKER'S LAWN & LEISURE**

1155 Milford Rd., Highland (810) 887-2410

M-59  
MILFORD RD. 1/2 MILE S. OF M-59

READ then RECYCLE

**Closed  
THANKSGIVING DAY  
November 28th**

All Used Auto Show Carpet

**\$1.50** sq. yd.

- Padding as low as 99¢ sq. yd.
- Must take carpet with you!

Friday, Nov. 29th 9am-9pm; Saturday, Nov. 30th 9am-9pm & Sunday, Dec. 1st 12pm-5pm

**DONALD E. McNABB  
CARPET COMPANY**  
31250 S. Milford • Milford  
(810) 437-8146

Open 7 Days  
Now 2  
Locations to  
serve you

**McNABB CARPET  
WAREHOUSE OUTLET**  
18236 Fort St. • Riverview  
1/2 mile north of Sibley

(313) 281-3330

5 mi. west of 12 Oaks Mall Exit 155 off I-96  
Open Mon.-Sat. 9 am-9 pm; Sun. 12 pm-5 pm

## BULLSEYE!

# Insider

BUSINESS JOURNAL

is right on target for businesses in Livingston & West Oakland counties

- Our readers have a median income of \$80,000.
- 69% of our readers have a college education or advanced degree.
- Our readership includes 211,000 readers of which 67% have been in business for 10 years or more.
- Average annual sales volume for these companies is \$750,000.
- 33% exceed \$1 million in sales.

Call today for more information.

(810) 220-1800

Save 25% off the newsstand price of \$24 per year, subscribe today for only \$18 per year!













512 Help Wanted Sales HOW DOES \$35,000 Per Year & Up Sound To You...

VICE PRESIDENT OF SALES & MARKETING Crosswinds Communities, Michigan's largest residential home builder/land developer...

560 Education/ Instruction ALL SUBJECTS K-5, patient, enthusiastic, 23 yrs exp. special general Ed. teacher consultant...

562 Business & Prof. Services ALL ADS TO APPEAR UNDER THIS CLASSIFICATION MUST BE PREPAID

630 Cards of Thanks ALL ADS TO APPEAR UNDER THIS CLASSIFICATION MUST BE PREPAID

638 Tickets AIR TICKETS (6) Detroit-Aspen, Colorado, Feb 8, return Feb. 16. \$451 ea. (313) 561-3099

706 Auction Sales THIS WEEK'S AUCTION Large Artiques, Collectibles, Furniture...

713 Garage Sales/ Moving Sales ALL ADS TO APPEAR UNDER THIS CLASSIFICATION MUST BE PREPAID

720 Bargain Buys 250 GAL. fuel oil tank, will deliver, \$50 (810)348-0895

INTERIOR DESIGNER In home sales of window treatments Full time Benefits plus mileage. Call Sga (313)769-5100

520 Help Wanted Part-Time Earn extra cash for the Holidays! Work out of South Lyon Herald office evenings, 5:15pm-8:45pm...

527 Babysitting/ Childcare Services A-1 SITTER, over 25 yrs exp Non-smoker, CPR, Reasonable Snacks, lunch. (810)231-1965

574 Business Opportunities \$5 HOMEWORKERS \$5 urgently needed. Earn weekly paychecks from the comfort of your own home...

640 Transportation/ Travel "Comfortable Transportation" Take a comfortable & affordable ride anywhere...

704 Arts & Crafts 6th Annual CHRISTMAS HOME SHOW GIFTS GALORE MAYCREST FARM

710 Estate Sales ACQUIRING & SELLING QUALITY FURNITURE DECORATIVE ACCESSORIES AND ANTIQUES

716 Household Goods 2 ETHAN ALLEN bedside chairs, \$50 ea. (810)220-8048

724 Business & Office Equipment BRUNING PD 101 blue print machine, excellent condition \$200. (810) 229-7838

OWN YOUR OWN BUSINESS CRUISESHIP CENTERS, Canada's Leading Cruise Vacation Specialists, has full and part time opportunities available for appropriate candidates in the Detroit Metro area...

537 Babysitting/ Childcare Services A-1 SITTER, over 25 yrs exp Non-smoker, CPR, Reasonable Snacks, lunch. (810)231-1965

600 Personal MINGLE & JINGLE Singles Night, Dec. 4th, Northstar Christmas Tree Lot, located on Wayne, between Joy & Warren Rds...

600-678 ANNOUNCEMENTS NETWORK MARKETING opportunity. Come listen & decide your destiny...

700 Absolutely Free ALL items offered in this "Absolutely Free" column must be exactly that, free to those responding...

700 Absolutely Free SEE ALSO... ADDITIONAL ADS FOR CRAFT SHOWS IN OUR "CRAFT DIRECTORY" IN THE CLASSIFIED SECTION

704 Arts & Crafts 6th Annual CHRISTMAS HOME SHOW GIFTS GALORE MAYCREST FARM

716 Household Goods COUCH & Chair, Large, Matching set. Good cond., \$325. (313)462-0709

Value Sales co. NEW WAREHOUSE SHOWROOM Just around the corner from Howell's Historic Courthouse NOW OPEN

524 Help Wanted Domestic CARE GIVER for elderly woman in position, 2-3-4 or 5 days/ wk. Good wages Call 9-5pm. (313)741-1601

530 Entertainment D.J. MUSIC for all occasions, all types available. Dom J (517)223-8572 after 6pm, weekdays.

538 Childcare Needed BABYSITTER FOR 8 & 10 yr. old children to get them off to school, 6:30am-8:30am, Mon-Fri. Milford area (810)684-6062

620 Announcements/ Notices 2ND ANNUAL cookie walk at Milford United Methodist Church, Dec. 14, 9am-2pm. (810)684-2798

700 Absolutely Free 12FT. WOOD garage door, complete retracting (810)220-2972

704 Arts & Crafts Arrow Auction Service Auction is our full time business Households - Farm Estates Business - Liquidations Roger Anderson (810) 227-6000

710 Estate Sales ESTATE SALE Closing household - furniture, kitchen ware, linens, books, women's clothing, hand tools, reception room chairs 7 tables, old postcards and records, some antiques, armoire, curtains and much more.

716 Household Goods LITTLE TYKES race car \$75; Step 2 chamber w/size \$75; white toddlers bed \$10. All in ext. cond. (810)231-3203

Value Sales co. DISCOUNTED NEW MATTRESSES New mattresses Queen Set... only \$199.00 Full Set... only \$149.00 Twin Set... only \$99.00

534 Jobs Wanted Female/Male ALL ADS TO APPEAR UNDER THIS CLASSIFICATION MUST BE PREPAID

540 Elderly Care & Assistance CERTIFIED NURSE Aide looking for 24 hr. care position. (517)851-4293

542 Nursing Care/ Homes BONUS! \$300. Group home in Brighton seeking part-time am, part-time pm & midnight position shifts working with developmentally disabled persons...

"GET LEGAL" Building License Seminar by Jim Klausmeyer (810) 887-3034

620 Announcements/ Notices 2ND ANNUAL cookie walk at Milford United Methodist Church, Dec. 14, 9am-2pm. (810)684-2798

700 Absolutely Free 12FT. WOOD garage door, complete retracting (810)220-2972

710 Estate Sales ESTATE SALE Closing household - furniture, kitchen ware, linens, books, women's clothing, hand tools, reception room chairs 7 tables, old postcards and records, some antiques, armoire, curtains and much more.

716 Household Goods LITTLE TYKES race car \$75; Step 2 chamber w/size \$75; white toddlers bed \$10. All in ext. cond. (810)231-3203

Value Sales co. DISCOUNTED NEW MATTRESSES New mattresses Queen Set... only \$199.00 Full Set... only \$149.00 Twin Set... only \$99.00





# GREEN SHEET CLASSIFIED

*The People's Marketplace*

## Now on the **INTERNET!**



Subscribers to HomeTown Online<sup>SM</sup> will be able to access the Green Sheet Classifieds Monday after 6 p.m.

The World will be able to access Ads Wednesday at 9 a.m.

### HomeTown Online<sup>SM</sup>

unlimited Internet access for  
only \$19<sup>95</sup> per month\*

**(517)545-1919**

\* no long distance phone fees for most of Livingston County

### GREEN SHEET CLASSIFIEDS

To place an ad call one of our local offices

(313)913-6032

(810)227-4436

(517)548-2570

(810)348-3022

(810)437-4133

(810)685-8705

24 Hour Fax (810)437-9460



1-800-579-SELL



*We're Easy to Find*  
<http://www.htonline.com>

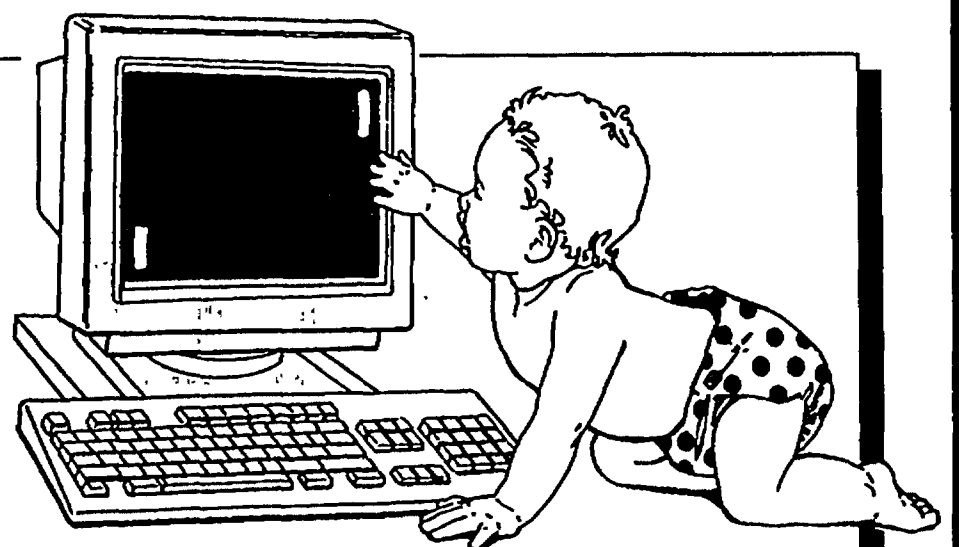

Make this a Holiday to remember for generations to come.

*Start recycling.*

Wrapping paper? *Recycle.*

Cardboard boxes? *Recycle.*

Nowadays, you can recycle just about anything.

Contact your local recycling center and find out more.

**HOME TOWN**™  
Newspapers

<b>822 Trucks For Sale</b> 1991 FORD F-150 XLT Lariat, 6 cyl. 65K, loaded, tonneau cover. \$8200 best. (810)220-1048. 1993 DODGE dually - diesel. Loaded, - exc. cond. \$16,500. (517)546-1772 after 6pm. 1993 FORD F-150 XLT, V8, auto, air, 71,000 miles. \$9,900. (313)522-8437 1993 FORD Ranger XLT Super cab, 38,000 miles. \$9,750. (810)380-7434 1993 RANGER XLT. Ar. exc cond. 4 cylinder. 5 speed \$6950 best. Must sell. (517)223-8930	1994 GMC Sonoma SLS exc. cab, red, loaded. 82k hwy. mi. Exc. cond. \$9400 best. (810)380-0920 1996 GMC SIERRA Z71 off road. Fully loaded, 4WD. 4yr. 60,000 mile warranty. \$26,000 best. Call Steve (313)420-3043 page # (313)793-7793. 1996 SOMOMA High Rider Extended cab - Black, all toys. low miles. Must see. \$22,500 best (810) 851-5766	1997 FORD F-150, short bed, V-8, 10,000 miles. \$16,800. Call after 5:30pm. (810) 699-9310 4 WD pick ups, dump trucks, & a van. Highest bidder. View Wed. - Sat. Nov. 27-30, 4895 Wash Dr., Brighton. City of Brighton vehicles - as is. bid at (810)227-9726.	<b>1984-1991 VANS WANTED</b> Instant cash. Call Dale in Lansing. (517)882-7299, Barn to 8pm any day! 1985 DODGE Caravan. 69,000 original miles, automatic, V-6, air, power, cruise. No rust. New in/out. \$3200 best. (313) 427-1885 1988 SAFARI SLE - V6, loaded. 7 passenger, trailer hitch. 111,500 miles. Excellent condition. \$4000 Call. (810)363-3866 1990 AEROSTAR, Eddie Bauer, extended. 75,000 miles, new tires. excellent. \$6500 (810)305-5449
---	--	---	--

**John Colone's**  
**'Holiday Week 1% SALE!'**  
SALE HOURS Mon.-Tue. til 8, Wed. & Fri. til 6, Sat. til 3

**1% OVER FACTORY INVOICE**  
**ON MORE THAN 150 VEHICLES**

*Just the right car for that trip to Grandma's* 

GREAT SELECTION & EVEN GREATER SAVINGS ON THE NATIONS FAVORITE MINIVANS, JEEPS, RAM TRUCKS, DAKOTAS AND MORE.

**HEAR YE!! HEAR YE!!**  
The areas exclusive provider of EASY CARE CERTIFIED AND GUARANTEED USED CARS AND TRUCKS

6 MO. - 6000 MILE Bumper to Bumper warranty on all CERTIFIED CARS  
100 POINT Quality and Safety Inspection

'93 COUGAR XR-7 LS Loaded & Certified <b>\$10,900</b>	'92 VOYAGER MINIVAN 2 To Choose From Certified, low miles, from <b>\$8,888</b>	'94 - 15 PASSENGER VANS 3 To Choose From, Only <b>\$11,499</b>	'94 DODGE STEALTH RT Moon roof and more Certified and Ready! <b>\$16,495</b>
'94 CONCORD Loaded, all power, oah <b>\$12,555</b>	'95 RAM CLUB CAB 1500 SLT LARAMIE Automatic, V8, full power <b>\$17,900</b>	'95 NEON 3 To Choose From <b>\$8,695</b>	SATURNS SL2 & SC2's 3 To Choose From <b>\$8,990</b>

**John Colone**  
"Just a little above the rest from high prices"  
Chrysler - Plymouth - Dodge - Jeep - Eagle

CHRISLER Dodge Jeep Eagle

DOWNTOWN PINCKNEY ON M-36  
(313) 878-3154 (313) 996-0086

SALE HOURS: Mon.-Tues. & Thurs. 9-4 Wed. & Fri. 9-4 SERVICE: Mon. Tues. & Thurs. 7-7 Wed. & Fri. 7-4

**Michigan's Original "SUPERSTORE"**

AT VARSITY FORD:  
**"WE'RE STUFFED"**  
...WITH GREAT DEALS ON GREAT USED CARS FOR THE HOLIDAYS!  
Varsity Ford Sale Ends Nov. 30 at 5 pm

**475** Used Vehicles Available

**LOW PRICES, GREAT PAYMENTS**

1988 MERCURY SABLE LS 4 DR. \$4,699 or \$139/mo.  
1991 PONTIAC 6000 LE 4 DR. \$5,499 or \$147/mo.  
1989 TOYOTA TERCEL 2 DR. \$3,899 or \$119/mo.  
1988 MERCURY SABLE WAGON GS \$4,299 or \$129/mo.  
1993 FESTIVA \$3,299 or \$89/mo.  
1988 HONDA PRELUDE SI \$4,899 or \$146/mo.  
1990 TAURUS GL WAGON \$5,799 or \$169/mo.

**TRUCKS, WORK TRUCKS, 2 WHEEL & 4 WHEEL DRIVE**

1994 F350 XL DUMP TRUCK \$16,899 or \$379/mo.  
1995 E-150 CARGO VAN \$16,999 or \$339/mo.  
1996 E150 CARGO VAN \$17,399 or \$349/mo.  
1999 F-150 XLT \$8,699  
1992 RANGER STX SUPERCAB \$7,799  
1994 F-150 SUPERCAB \$15,799 or \$354/mo.  
1993 RANGER SUPERCAB 4x4 XLT \$13,799 or \$334/mo.  
1995 F-250 XLT 4x4 SUPER CAB \$19,999 or \$399/mo.  
1999 F-350 TRUCKS AVAILABLE. COME AND SEE WHY WE'RE THE LARGEST FORD TRUCK DEALER FOR MILES AROUND.

**SPORT UTILITIES**

1992 BRONCO XLT \$13,699 or \$329/mo.  
1993 EXPLORER 2 DR. \$12,599 or \$305/mo.  
1994 EXPLORER EDDIE BAUER 4 DR. 4 WHEEL DRIVE \$19,999  
1995 EXPLORER SPORT \$21,699

**ECONOMY**

1995 ESCORT LX WAGON \$8,999  
1996 PLYMOUTH NEON \$9,999 or \$199/mo.  
1995 MERCURY TRACER TRIO \$10,399 or \$209/mo.  
1993 FESTIVA \$4,999 or \$119/mo.

**MINI VANS & CONVERSIONS**

1995 WINDSTAR LX \$15,699 or \$314/mo.  
1995 VILLAGER GS \$16,399 or \$329/mo.  
1992 CLUB WAGON XLT \$8,999 or \$219/mo.  
1994 AEROSTAR XL PLUS \$12,999 or \$289/mo.

**LUXURY AND SPORT**

1995 CONTOUR SE \$13,499 or \$269/mo.  
1996 MUSTANG GT CONVERTIBLE \$21,499  
1993 CENTINALE \$14,999 or \$359/mo.  
1994 PROBE GT \$11,999 or \$269/mo.  
1993 LINCOLN TOWN CAR \$13,999 or \$339/mo.

**Varsity Ford**  
3480 Jackson Rd. | Ann Arbor  
(313) 996-2300 | Call Toll Free 1-800-875-USED  
Open Mon. & Thurs. 9-9; Tues., Wed., Fri. 9-6; Open Sat 9-5



# CHAMPION

## USED CAR CONNECTION

**THANKSGIVING WEEKEND ONLY! TWO DAY RED TAG SALE**  
 FRIDAY NOVEMBER 29, 9:00 A.M. - 6:00 P.M. & SATURDAY NOVEMBER 30, 9:00 A.M. - 4:00 P.M.  
 HUGE CLEARANCE SAVINGS - LARGE SELECTION

**More than just a great price!**

- Certified Sales Consultants**  
All Champion sales consultants undergo an intensive training program to deal with customer's needs successfully, always keeping budget concerns in mind.
- Easy On-Site Financing**  
Champion provides easy, on-site financing with 15 accredited lending institutions to choose from and finance and payment tailored to fit your needs.
- Warranty On All Vehicles**  
All vehicles under 100,000 miles and less than ten years old are covered by an extensive warranty. See dealer for details.
- 52-Point Mechanical Inspection**  
All vehicles undergo a rigorous 52-point inspection by factory trained, state certified, authorized technicians before going on sale.
- Low Down Payments & Monthly Payments**  
Champion certified sales consultants work with you to arrange affordable down payments and monthly payments.
- Poor Credit History?**  
Champion says "Yes" when others say "No". Credit specialists provide "cash-out" financing despite divorce, layoff or other past problems.

**BAD CREDIT? BANKRUPT?**  
 1. You must be employed  
 2. Have a trade or down payment  
**IT'S EASY, IT'S FAST!**  
 810-229-8800  
 517-545-8800  
 Ask for Dave Cabell  
 Phone Applications Accepted

### GM Certified USED VEHICLES

Vehicles that carry this label meet GENERAL MOTORS standards, including 110 point appearance & servicing inspection & reconditioning, vehicle history & campaign check, market based NO HAGGLE pricing, a customer friendly sales environment, a 12/12 GM Certified Used Vehicle limited warranty, including roadside assistance, and a 3 day/150 mile money back guarantee!

**ASK ABOUT OUR "0" DOWN LEASE PROGRAMS!**

### TRUCKS, MINIVANS, 4x4's & SPORT UTILITIES

'94 TRACKER CONVERTIBLE Bal. new truck warranty low mil. 2 to choose! From	'95 TOYOTA 4x4 Ready for winter! Extra clean!	'95 SONOMA SLE EXT. CAB 4.3L V6, auto, air, loaded!	'94-5 FULL SIZE CONVERSION VANS 8 to choose from! Bal new van warr!	'96 F150 PICKUP Only 13,000 miles! Bal new truck warr!	'94 S10 4x4 Auto, air, 4.3L V6, loaded!	'95 WRANGLER HARDTOP 4x4 Low miles! bal new truck warr!	'95 RANGERS SPLASH 4x4 V6, only 15,000 mi, bal new truck warr!	'92 SUBURBAN 4x4 Extra clean! Won't last long!	'95 1500 4x4 PICKUPS 3 to choose! From	'96 CHEROKEE 4x4 V6 low mi! Bal new truck warr!	'95 BLAZER 4 DR 4x4s 10 to choose from, SAVE THOUSANDS, bal new truck warr! From	'96 BLAZER 4 DR 4x4s 8 to choose from, SAVE THOUSANDS, bal new truck warr! From	'95-6 TAHOE 4 DR 4x4s Loaded low miles, 3 to choose from, SAVE THOUSANDS bal new truck warr!
'93 S10 EXT. CAB PICKUP Includes air conditioning!	'94 F150 PICKUPS Automatics, 2 to choose! From	'95 DAKOTA SPORT PICKUP Only 21,000 miles, bal. new truck warr!	'95 RAM 1500 PICKUP Bal. new truck warr., only 27,000 miles!	'96 S10 PICKUP Only 15,000 miles, bal new truck warr!	'94 F150 PICKUP 3 to choose! From	'94 WRANGLER 4x4 V6, ready for winter driving!	'93 EXPLORER 4x4 Automatic, loaded, V6, etc!	'95 TRACKER HARDTOP 4x4 Auto, A/C, only 24,000 miles, bal new truck warr!	'92 S10 BLAZER 4x4 4 DRs 2 to choose! From	'95-6 1500 & 2500 PICKUPS 15 to choose from, 2WD & 4WD, Reg Cab & Ext Cab, bal new truck warr!	'94 SONOMA 4x4 Automatic, V6!	'95 VOYAGERS & CARAVANS 7 to choose! From	SAVE THOUSANDS! CALL FOR DETAILS



### BUDGET VEHICLES

'90 STORM Automatic, only 67,000 miles!	'91 PROBE GT Incl. elec. moonroof! Won't last long!	'89 SEVILLE Drive in Cadillac luxury!	'91 CAVALIER Auto. & air! Lots of equipment!	'91 CUTLASS Only 68,000 miles! Hurry!	'91 CIVIC Great gas mileage!	'90 TRANSPORT Front wheel drive! Room for everybody!	'91 FIREBIRDS 3 to choose! From
'89 AEROSTAR Low miles! Room for the whole family!	'91 SUZUKI SIDEKICK New car trade-in!	'91 S10 PICKUPS 3 to choose! From	'93 METROS Great on gas! 2 to choose! From	'89 PROBE Automatic and air! Low miles!	'89 REGAL 6 cyl., loaded, low mi. Hurry!	'95 PRIZM LSI Auto & air - Loaded!	'95 GRAND AM SE Automatic, V6, A/C, loaded! 350 VEHICLES AVAILABLE! ALL MAKES & MODELS!

### THE BEST OF THE REST

'95 CAMAROS & FIREBIRDS 5 to choose, 5 spd & auto, V6 & V8!	'94 LUMINA Auto., A/C, V6, loaded! Hurry!	'93 SENTRA Automatic, loaded! Great buy!	'93 GRAND AM SE Loaded with options! Extra clean!	'95 CORSICAS Loaded! 12 to choose! From	'94 SKYLARK First one gets it!	'95 BERETTAS 2 to choose! Low miles! Well-equipped! From	'95 CUTLASS Loaded extra clean!
'94 GRAND AM GTS Loaded, V6, auto! 2 to choose! From	'95 SATURN SW2 WAGON Low mi., loaded, new car trade-in!	'94-5 CORVETTES 4 to choose from! Call for details!	'96 NEONS 3 to choose! Low mi., bal. new car warr! From	'95 GRAND PRIX SES 6 to choose! Low miles, V6, loaded! From	1996 CHEVY CORSICA 30 to choose from. Good miles, lots of equipment. Starting at \$8995.00 or \$139.00 mo.*		

## GM Employees & Family Members Save An Additional 5% 1996 FACTORY CLOSEOUT SALE!

<b>1996 CAVALIER</b> Was \$14,344 Stock #1527  Now <b>\$12,125*</b>	<b>1996 CAMARO</b> Was \$20,032 Stock #1207  Now <b>\$16,485*</b>	<b>1996 ASTRO LS</b> WAS \$24,105 Stock #6124  Now <b>\$19,995*</b>
<b>1996 LUMINA LS</b> Was \$20,875 Stock #1393  Now <b>\$16,865*</b>	<b>1996 S-SERIES TRUCK</b> Was \$17,395 Stock #5748  Now <b>\$14,495*</b>	<b>1996 C-1500 SILVERADO</b> Was \$22,934 Stock #6116X  Now <b>\$18,769*</b>
<b>1996 MONTE CARLO LS</b> Was \$18,881 Stock #1457  Now <b>\$15,595*</b>	<b>1996 TRACKER</b> WAS \$16,463 Stock #5764  Now <b>\$12,995*</b>	<b>1996 CONVERSION VANS</b> Hurry-in to Mid-Michigan's #1 Chevy-Geo Dealer Starting At <b>\$18,495*</b> 15 To Choose From

# CHAMPION

5000 E. GRAND RIVER AT EXIT 141 1-96  
**517-545-8800 • 810-229-8800**

**GE**  
**CHEVROLET**

**HOURS**  
 Mon., Thur. 9 a.m. - 9 p.m.  
 Tues., Wed., Fri. 9 a.m. - 6 p.m.  
 Sat. 9 a.m. - 4 p.m.

\*All prices plus tax, title, destination, doc. & fee. All rebates to dealer. GM employees & family members save additional 5%. Vehicles may not be exactly as pictured. Payments are based on 20% down payment, plus tax, title and fees. 95% & 96% to finance for 60 mos. @ 10.25% APR. 94% to finance for 60 mos. @ 11% APR. 93% to finance for 60 mos. @ 11.25% APR. 92% to finance for 48 mos. @ 12% APR. 91% to finance for 48 mos. @ 12.5% APR. 90% & older to finance for 36 mos. @ 13% APR. Terms & rates may vary depending on lending institution. Subject to credit approval & all vehicles are subject to pre-sale.









JAY CHEVROLET

OPEN SAT. 10-4

JAY CHEVROLET

OPEN SAT. 10-4

JAY CHEVROLET

VISIT OUR NEW HOME . . .

# JAY CHEVROLET



## Thanksgiving Savings

### 1997 GEO TRACKER

2 dr. 4x4 Convertible

STOCK #5033



**\$199\* MO.**  
36 MONTHS

WITH GM DISCOUNT

### 1997 BLAZER 2 DR. LS

STOCK #5061

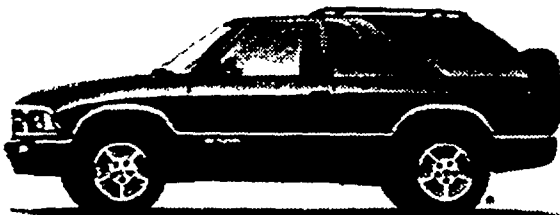

**\$199\* MO.**  
24 MONTHS

WITH GM DISCOUNT

### 1996 CONVERSION VAN

Loaded Custom Van!

STOCK #2506



**\$299\* MO.**  
24 MONTHS

WITH GM DISCOUNT

## USED CAR SAVINGS



1992

### GMC SAFARI

A.W.D. Conversion Van, V-6, tilt, cruise, pw, pl, cassette, low miles, showroom clean

**\$12,990**

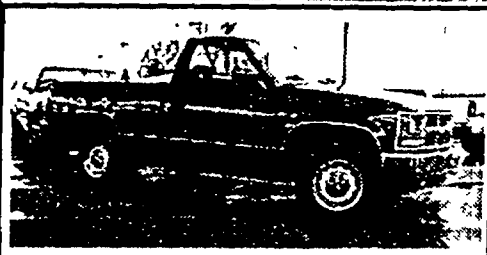

1994

### CHEV. 4x4 WORK TRUCK

auto, air, bedliner, like new!

**\$15,990**



1995

### CHEV. ASTRO CL

V-6, loaded, power seats, like new!

**\$16,990**



1994 CHEV.

### 1500 SERIES EXT. CAB

Silverado Edition, only 40,000 miles, like new with matching cap.

**\$16,990**

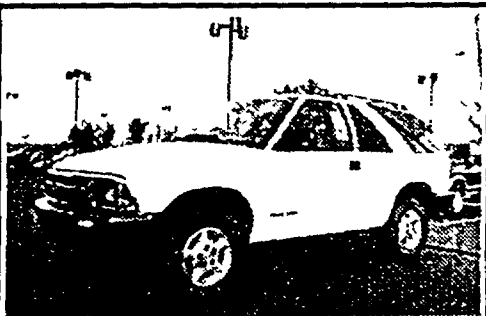

1995

### CHEV. BLAZER LS 4x4

Only 18,000 miles, loaded and we mean loaded!

**\$17,990**



1994

### GMC YUKON 4x4 SLE

43,000 miles

**\$19,990**



1994

### GMC SUBURBAN 4x4 SLE

8 cyl., loaded, must see!

**\$19,990**



1995

### CHEV. TAHOE 4 DR. 4x4

loaded with all the toys, must see!

**\$24,995**

3372 W. HIGHLAND RD. (M-59) • HIGHLAND  
4 MINUTES EAST OF US 23

**(888) JAY-CHEV**  
**(810) 684-1025**

SHOWROOM: Mon. & Thurs. 8 to 9  
Tues., Wed., Fri., 8 to 6  
OPEN Saturday 10 to 4  
Service: Mon.-Fri. 7:30am to 7

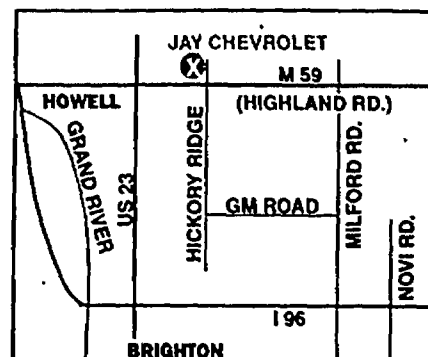

OPEN SAT. 10-4

JAY CHEVROLET

OPEN SAT. 10-4

JAY CHEVROLET

OPEN SAT. 10-4

OPEN SAT. 10-4

JAY CHEVROLET

OPEN SAT. 10-4

JAY CHEVROLET

OPEN SAT. 10-4

JAY CHEVROLET

OPEN SAT. 10-4

JAY CHEVROLET

OPEN SAT. 10-4

JAY CHEVROLET

OPEN SAT. 10-4

JAY CHEVROLET

OPEN SAT. 10-4

JAY CHEVROLET

OPEN SAT. 10-4

JAY CHEVROLET

Thursday, November 24, 1994 GREENSHEET EAST/CHRYSLER LIVING - DT7



### THE APOLLO ADVANTAGE! WE WON'T BE BEAT!

"No Hassle!  
Low Price Guarantee!"  
Every Apollo Car Priced Below NADA Official Used Car Guide Central Edition Retail Value.  
Buy With Confidence!  
33 Point Quality Inspection  
90 Day or 4,000 Mile Warranty On Every Used Car Purchase  
Fast, Affordable Financing From A Variety Of Sources For Almost Any Need!

**\$1995 to \$5995**  
1988 PLYMOUTH VOYAGER V6, auto., av. fully loaded.....\$3,995  
1989 FORD CLUB WAGON 12 passenger, 1 owner, 34,000 mi.....\$4,995  
1990 SUBARU JUSTY GL 4 WD, only.....\$2,995  
1985 PONTIAC FIERO GT Auto., air, fully loaded.....\$2,995  
1992 FORD ESCORT GT 1 owner.....\$3,995

### \$5995 to \$9999

1990 OLDS CUTLASS INTERNATIONAL Fully loaded, low mi., super sharp.....\$6,995  
1988 AEROSTAR XL Low mi., 1 owner.....\$4,995  
1995 PLYMOUTH NEON Auto., air.....\$8,495  
1991 LINCOLN TOWN CAR Executive Series, fully loaded, leather.....\$8,995  
1989 DODGE CARAVAN 1 owner, 44,000 mi.....\$5,995  
1994 RANGER SUPER CAB XLT Fully loaded, air.....\$9,995  
1993 MERCURY TRACER Auto., air, 1 owner.....\$6,995  
1994 FORD ESCORT LX Air, stereo, cassette.....\$6,995  
1993 FORD TEMPO GL Auto., air, 21,000 miles.....\$7,995  
1994 PONTIAC SUNBIRD LE Auto., air, 39,000 miles.....\$7,995

### Luxury, Sport & More

1994 LINCOLN TOWN CARS 3 to choose from.....\$15,900  
1996 CONTOUR Fully loaded, auto., air, sunroof 12,600 mi.....\$12,500  
1994 FORD PROBE GT Moonroof, 1 owner, fully loaded.....\$9,995  
1995 EXPLORER 4x4 Eddie Bauer 7,000 mi loaded! MSRP: \$34,625 Now.....\$26,996  
1992 LINCOLN CONTINENTAL Exec. Series, fully loaded, 1 owner.....\$9,900  
1994 LINCOLN MARK VIII Deep jewel green, 1 owner, loaded, hands free phone.....\$17,994  
1994 MERCURY SABLE LS power moonroof, low miles, 1 owner.....\$11,900  
1996 MERCURY GRAND MARQUIS LS 1 owner, fully loaded, 18,000K mi.....\$18,996  
1989-1994 FORD AEROSTARS 5 to choose from.....\$3,995  
1996 LINCOLN CONTINENTALS All fully loaded, keyless, V8, alum. wheels, 3 to choose from.....\$24,996  
1994 ESCORT GT Fully loaded, 32,000 mi., 1 owner.....\$7,995  
1994 MERCURY VILLAGER GS Fully loaded, 1 owner.....\$12,900  
1994 FORD TAURUS SHO Fully loaded, auto., air.....\$10,900  
1996 LINCOLN TOWN CARS All fully loaded, leather, keyless entry, sun, wds., p. seats, 8 to choose! Special Purchase! From.....\$24,996  
1994 GRAND MARQUIS LS Fully loaded, 1 owner, 27,000 miles.....\$14,495  
1995 FORD THUNDERBIRD Auto., V8, p.w., p.l., tilt, cruise, air, only.....\$11,900  
1994 LINCOLN CONTINENTALS 4 to choose. All fully loaded, from.....\$12,900  
1996 MERCURY SABLE LS All fully loaded, ABS, keyless entry, low, low miles. 5 to choose. From.....\$14,995  
1995 PONTIAC GRAND PRIX SE 2 door, fully loaded.....\$11,900

**APOLLO** LINCOLN MERCURY  
2100 W. Stadium at Liberty  
Ann Arbor, MI 48106  
668-6100  
Mon & Thur 9-9  
Tues, Wed, Fri 9-6  
Sat 10-3  
\$1000 mi. 1998 or newer

BRIGHTON HONDA MAZDA • BRIGHTON HONDA MAZDA

# BRIGHTON HONDA MAZDA

**'93 HONDA DEL SOL SI**  
Air, alloy wheels, sporty & fun!  
Reduced **\$9,995** (this is not a misprint)

'94 HONDA ACCORD EX	'90 MITSUBISHI MIRAGE Great transportation, low miles. Auto. This week reduced to:	'92 MAZDA MX3 Good miles, black, 5 spd. This week only:
\$14,988	\$4,995	\$7,371
'92 MAZDA PROTEGE Auto, air, 4 door, great investment	'94 MAZDA TRUCK 2 dr, only 30K, sharp, auto	'90 ISUZU TROOPER Very rare, 414, green, 4 door.
\$7,995	\$7,954	Hurry \$8,987
'95 MAZDA PROTEGE Low miles, factory warranty, air, auto. reduced to \$9,995 today you choose	'93 HONDA ACCORD LX 2 dr, only 30K, sharp, auto	'95 MAZDA MPV
\$9,995	\$11,987	\$12,379

**BRIGHTON HONDA MAZDA**  
8704 W. GRAND RIVER • BRIGHTON  
810 227-5552  
Open Saturday 9am - 3pm

BRIGHTON HONDA MAZDA • BRIGHTON HONDA MAZDA

## CHAMPION USED CAR CONNECTION

603 West Grand River, Brighton (810)-227-1550

AS LOW AS \$82 A MONTH!

CAR SPECIAL OF THE WEEK '93 FORD FESTIVA 2 DR. \$1,995

'93 GEO METRO 3 dr. hatch, auto \$4,495..... or.....\$82/mo.	'92 FORD ESCORT 3 dr. hatch \$4,195..... or.....\$85/mo.
'92 SUBURBAN 4X4 Ecra clean, 9 pass \$17,995..... or.....\$368/mo.	'94 DODGE CONVERSION Full power \$13,995..... or.....\$255/mo.
'95 TOYOTA PU 4x4 & clean \$12,495..... or.....\$207/mo.	'94 RANGER P.U. Low miles \$6,995..... or.....\$127/mo.
'95 MERC MYSTIQUE Air, auto, cass. \$10,995..... or.....\$182/mo.	'95 CHEV. CORSICA SL #4067PT \$8,995..... or.....\$149/mo.
'94 GD AM GT 4 dr. auto & clean \$10,995..... or.....\$199/mo.	'91 CHEV. S10 P.U. Clean - Good Miles \$4,495..... or.....\$102/mo.
'93 DODGE DYNASTY 4 dr. V6 \$6,795..... or.....\$124/mo.	'94 GEO TRACKER Soft top \$8,995..... or.....\$164/mo.

TRUCK SPECIAL OF THE WEEK '93 F150 PICKUP \$1,595

AUTO LOANS - Slow Pay, No Credit, No Collateral. Call Tony 810-227-1550

95's to finance for 60 mos @ 9% APR. 94's & 93's to finance for 54 mos @ 9.5% APR. 92's to finance for 48 mos @ 10.5% APR. 91's to finance for 42 mos @ 10.5% APR. 90's & down for 36 mos @ 13.5% APR

Fresh Start Financing We Say Yes When Others Say No!

**DOWNTOWN BRIGHTON**

Who should you turn to with questions about your medicines?



### Team Up & Talk With Your Pharmacist

Your pharmacist is one good answer. You may not know that your pharmacist can help you understand how to take your medications properly. This is one of the best ways to decrease your overall health care costs—and your pharmacist is there to help you get the most from your medications.

By working together with your pharmacist, you can be sure that your medications will make you better when you are sick or help keep you healthy.

Your pharmacist can help you get the most from your medicines, so be sure to ask your pharmacist...we are always there for you... helping your medicines help you.

**APHA**  
A Program of the American Pharmaceutical Association  
The National Professional Society of Pharmacists

Frustrated? Have a Dispute?



We provide mediation and conciliation services  
Livingston Community Dispute Resolution Service  
Call (517) 546-7530

## Special Financing or Factory Rebates on 1996 WINDSTAR'S

# 4.99% APR

or 5.99% APR



Red Carpet Lease.

## QUALITY PRE-OWNED VEHICLES

 <b>1994 FORD EXPLORER LIMITED</b> Power moon roof, every available option Only <b>\$19,900</b>	 <b>1996 FORD EXPLORER XLT</b> 9,000 miles, running boards, loaded, cassette Only <b>\$22,900</b>
 <b>1993 FORD F150 XLT 4x4</b> Green, auto., full power, running boards, fiberglass cap, cassette Only <b>\$14,600</b>	 <b>1995 LINCOLN CONTINENTAL</b> Pearl gold, 6 CD changer, cassette, factory phone, leather, must see! Only <b>\$23,900</b>
 <b>1996 FORD THUNDERBIRD LX</b> Dark teal, loaded, 23,000 miles Only <b>\$12,900</b>	 <b>1991 FORD RANGER XLT</b> Cassette, air, bedliner, clean! Only <b>\$5,600</b>
 <b>1995 FORD TAURUS GL</b> Dark green, loaded, like new Only <b>\$13,900</b>	 <b>1995 MERCURY GRAND MARQUIS LS</b> 16,000 miles, leather, digital dash, fully loaded, must see! Only <b>\$18,900</b>

# HILLTOP

**FORD, LINCOLN & MERCURY**  
2798 E. Grand River, Howell

## HILLTOP HOTLINE

1-800-258-5603

HOURS: Showroom 8 am-9 pm Mon. & Thurs. 8 am-6 pm Tue., Wed., Fri. 9 am-3 pm Sat.  
Parts, Service, Body Shop 8 am-6 pm Tues., Wed., Fri.

JUST 2 MILES EAST OF HOWELL ON GRAND RIVER

\*All vehicles subject to prior sale. All prices plus tax, license & doc. fees. 36 mos. lease plus reg. fee and taxes. \$3000 cash or trade down.  
\*\*All vehicles subject to prior sale. Prices plus tax, lic. and doc. fees. 24 mos. lease plus reg. fee and taxes. \$200 cash or trade down.

WALDECKER SAVINGS FEAST

WALDECKER SAVINGS FEAST

Open  
Friday &  
Saturday  
Normal Hours

# GOBBLE the SAVINGS



Our Cars Are  
Tagged With  
Thanksgiving  
Savings.

**1997 OLDSMOBILE CUTLASS SUPREME SL**  
Sedan Stk. 7357,  
3100 SFI V6, 16" alum., wheels  
pwr. windows, cruise.  
**\$17,995\***  
GM EMP. SAVE ADDL. \$947.50

**1997 OLDSMOBILE EIGHTY EIGHT**  
Stk. 7274, 3800 Series II V6, loaded, full power  
new design  
**\$21,210\***  
GM EMP. SAVE ADDL. \$1,124.75

**See You Friday & Saturday For These Specials!**

**1996 BUICK REGAL**  
Stk. 6364, 3800 Series II, V6, remote keyless entry, steering wheel  
controls, full power, prestige pkg.  
**\$18,314\*** Includes Rebate  
in lieu of 3.9%

**1997 PONTIAC BONNEVILLE SE**  
Stk. 7048, 3.8 Series II, V6, 16" alum. wheels,  
4 spd. auto., remote keyless entry, spoiler,  
AM/FM cass., pwr. mirrors, 6 way driver seat  
**\$22,399\*** Includes Rebate  
in Lieu of 3.9%

**1997 PONTIAC SUNFIRE GT COUPE**  
Stk. 7101, 4 spd. auto., air, rear defog, AM/FM, CD, cruise  
control, cycle wipers, steering wheel, radio controls  
**\$15,991\*** Includes Rebate  
in Lieu of 3.9%

**Closeout Price**

**1996 GEO TRACKER CONVERTIBLE**  
Stk. 6457, folding rear seat, body side  
molding, 5 spd., p. steering, AM/FM stereo  
**\$10,995\*** after rebate  
GM EMP. SAVE ADDL. \$705.45

**1997 CHEVY S-10 PICKUP LS**  
Stk. 7360, 5 spd., aluminum wheels,  
AM/FM cass., cloth seat.  
**Bargain Priced At \$11,760\*** after rebate  
GM EMP. SAVE ADDL. \$619.70

**1996 PONTIAC GRAND AM SE COUPE**  
Stk. 6373  
Dual airbag, ABS brakes  
daytime running lamps  
pwr. locks,  
4 spd. auto.,  
14" steel wheels.  
Spoiler, air control cycle,  
wipers, defog, AM/FM cass.  
**\$14,249\*** Plus rebate  
in lieu of 3.9%

**1997 CHEVY CAVALIER 4 DR**  
Stk. 7399, auto., air, rear defog, AM/FM cass.,  
body side moldings, intermittent wipers  
**\$13,499\***  
GM EMP. SAVE ADDL. \$683.30

**1997 CHEVY 1/2 TON WORK TRUCK**  
Stk. 7362, bench seat,  
air, 4300 V6 Vortec,  
AM/FM cass., tilt, step  
bumper, heavy duty  
trailer  
**\$17,289\*** GM EMP. SAVE  
ADDL. \$886.20

**The All New Venture**

**1997 CHEVY VENTURE**  
Stk. 7322, 3.4 V6, 4 spd.  
auto., AM/FM cass.,  
luggage carrier, cruise,  
p.w., 7 pass., remote  
keyless entry  
**\$20,995\*** GM EMP. SAVE  
ADDL. \$1,078.40

**1997 PONTIAC GRAND AM GT 4 DR**  
Stk. 7084, sport interior group 3.1 V6 auto 4  
spd. air AM/FM CD player, cruise defog power  
mirrors pwr windows Remote keyless entry  
**\$17,253\*** Includes Rebate  
in Lieu of 3.9%

**1996 BUICK CENTURY SPECIAL**  
Stk. 6593 14" aluminum wheels, power locks, windows tilt  
**\$15,499\*** Includes Rebate

WALDECKER SAVINGS FEAST

WALDECKER SAVINGS FEAST

## WALDECKER



New Location!  
Chevrolet - Oldsmobile - Geo  
880 S. Grand, Fowlerville (Near I-96)  
(517) 223-9142  
Hours: Mon. & Thurs. 8:30-9;  
Tues., Wed. & Fri. 8:30-6; Sat 10-4

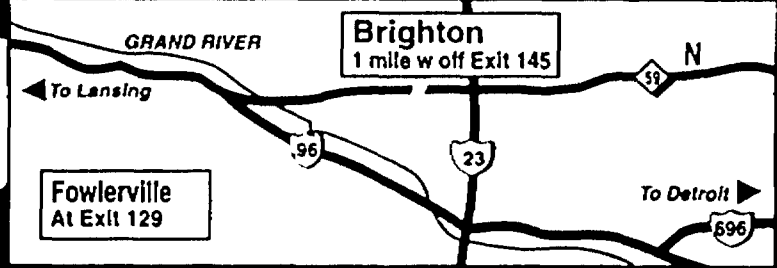

**Pontiac-Buick**  
7885 Grand River, Brighton  
(810) 227-1761  
Hours: Mon. & Thurs. 8:30-9;  
Tues., Wed. & Fri. 8:30-6; Sat 9-4

Prices effective thru 12/3/96. Subject to presale. All prices, plus taxes, title and plates. After rebate. Pictures do not necessarily represent vehicles.

### YOUR "GM CONNECTION" in LIVINGSTON COUNTY

#### FOWLERVILLE'S USED CARS

#### FOWLERVILLE'S TRANSPORTATION SPECIALS

'86 FORD ESCORT 2 Dr., silver, 73,400 miles	\$1,995
'88 CHEVY CORSICA 4 dr., auto, air	\$3,995
'91 CALAIS 4 DR 44,100 miles, auto air.	\$5,995
'92 CIERA SL Auto, air, many extras	\$5,995
'82 BUICK SKYLARK 77,200 original miles	\$2,995
'84 RANGER 4x4 XLT 6 cyl	\$2,995
<b>TRUCKS</b>	
'96 SUBURBAN LT Loaded	\$28,995
'95 CHEVY 1500 W/T 6 cyl., 5 spd., 24,600 miles	\$16,995
'95 LUMINA APV 3800 V6, p. sliding door	\$17,995
'95 CHEVY 1500 Reg. cab, long box, 18,600 miles	\$9,995
'94 BLAZER 4x4 4 dr., many extras	\$17,995
'94 GMC JIMMY SLT Leather, only 30,000 miles	\$17,995
'94 CHEVY 1500 Long box	\$9,995
'93 TRACKER 4x4 Convertible	\$7,950

'92 GMC JIMMY SLE 4x4 Red	\$14,150
'92 LUMINA APV 6 cyl., 7 pass	\$9,995
'90 OLDS SILHOUETTE P. seat	\$8,995
<b>CARS</b>	
'96 OLDS CUTLASS SUPREME	\$14,995
'95 BUICK CENTURY White, 6 cyl., sharp	\$10,995
'95 PONTIAC GRAND AM 4 Dr., only 23,600 miles	\$14,995
'94 GEO METRO 2 dr., gas saver	\$6,995
'94 LUMINA 4 dr., 6 cyl., full power, only 15,300 miles	\$10,995
'94 CAVALIER 2 dr., RS, bright blue, 28,000 miles	\$8,995
'94 GRAND AM Quad 4, auto., air	\$9,995
'94 CIERA WAGON Third seat, hard to find	\$11,995
'93 SUPREME 4 dr., 6 cyl., many extras	\$10,995
'92 PONT. GRAND PRIX Coupe, Euro pkg.	\$9,995

#### BRIGHTON USED CARS LOT

'94 CHEVY CAVALIER 2 dr., Blue, low miles, auto & air, only	\$7,500
'93 PONT. GRAND PRIX 2 dr., teal, full power, 32,000 mi. Only	\$10,900
'95 BUICK RIVIERA Burgundy full power 24,000 mi. Only	\$20,900
'92 PONT. SUNBIRD GT 2 dr., loaded, only 19,000 mi. must see Only	\$9,900
'91 TOYOTA COROLLA 5 spd w air, only	\$4,500
'92 OLDS DELTA 88 ROYALE Blue full power	\$7,900
'93 CHEV. LUMINA EURO 2 dr., full power, low miles, new, only	\$8,900
'93 PONTIAC GRAND PRIX SE 2 dr., White, loaded, extra clean	\$9,900
'92 PONTIAC FIREBIRD Loaded, formula, Triops, 4200 mi., only	\$9,900
'95 DODGE INTREPID ES Loaded, sharp, only	\$11,900
'95 GMC SONOMA PU Black V6, auto, air, SLE, low miles, only	\$11,900
'92 BUICK LESABRE Silver, loaded, low miles, one owner, only	\$11,900
'95 PONTIAC GRAND PRIX SE 4 dr., Dk. Teal, loaded, extra sharp, one owner, only	\$12,900
'95 BUICK CENTURY White, V6, full power, program car, only	\$11,900
'94 CHEVY ASTRO CONVERSION VAN Burgundy like new, loaded, only	\$12,900
'94 FORD EXPLORER 2X4 2 dr., extra clean	\$12,900
'95 BUICK CENTURY 4 dr., Tan, full power, 12,000 miles	\$13,900
'93 GMC SAFARI EXT VAN All wheel drive, loaded, low miles, only	\$13,900
'94 BUICK LeSABRE CUSTOM Lt Blue, full power, one owner, only	\$13,900
'94 BUICK LeSABRE CUSTOM White, loaded, one owner, only	\$13,900
'94 BUICK LeSABRE LIMITED Black, full power, w/leather, only	\$14,400
'95 CHEVY MONTE CARLO LS White, loaded, off lease, only	\$14,900
'96 PONTIAC GRAND AM 2 dr., Lt. Green, 2600 mi., loaded	\$14,900
'95 CHEVY MONTE CARLO Z34 Black/Black, loaded, showroom new, only	\$15,900
'95 OLDS SILHOUETTE Dk. Teal, loaded, dual air, showroom new, 20,000 mi., only	\$16,900
'95 GMC JIMMY SLT 4X4 Loaded, 4 dr., Burgundy w/leather, only	\$19,900
'96 CHEVY EXT. CAB PU Blue, Silverado, full power, 7300 miles, only	\$21,900
'96 CHEVY BLAZER 4 dr., Aqua Green, 4x4, full power, showroom new, 8000 mi., only	\$24,900

WALDECKER SAVINGS FEAST

WALDECKER SAVINGS FEAST

WALDECKER SAVINGS FEAST

WALDECKER SAVINGS FEAST

# WRAP IT UP!

A HOLIDAY GIFT GUIDE

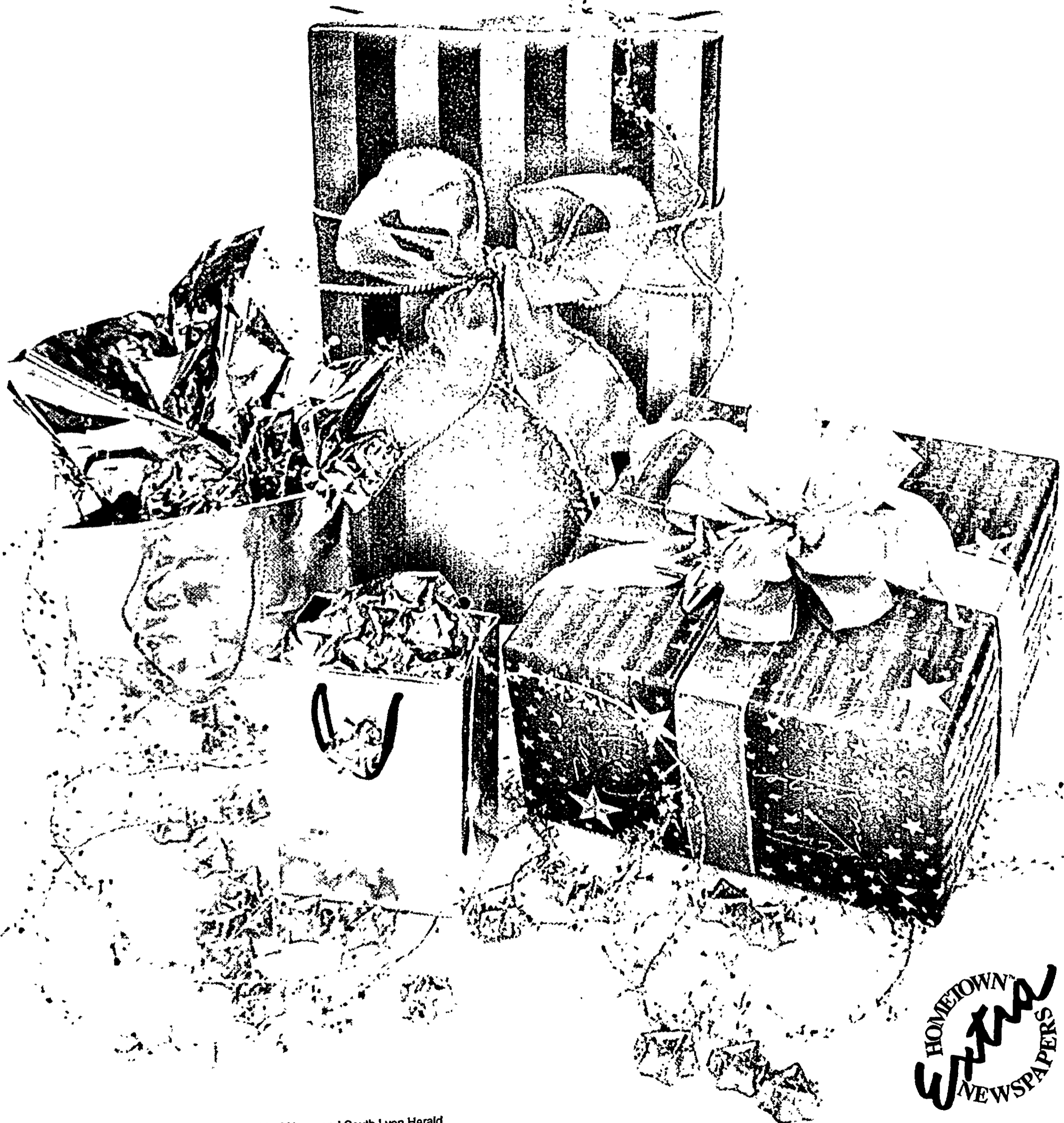

HOMETOWN  
*WTHM*  
NEWSPAPERS

Supplement to the Milford Times, Northville Record, Novi News and South Lyon Herald

# Custom Designing

- 4 Craftsmen
- 2 Designers
- 1 G.I.A. Certified Graduate Gemologist

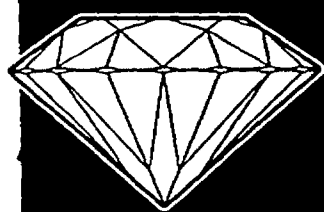

## In Store Jewelry Repair

### We Service

- Rolex®
- Omega®
- Concord®
- Movado®
- Rado®
- Ebel®
- Cyma®

# Direct from Israel



**E**liminate the middlemen, and save hundreds, even thousands of dollars by purchasing direct from Israel. Our vast inventory and purchasing power has made us a great source for diamonds. Dean Rottermond has made direct buys from the diamond cutting centers of the world. We feature many diamonds from 1 carat up to 5 carat stones. All are certified diamonds.

Call for your appointment today, or stop in at your convenience. Our staff will be pleased to assist you in your diamond selection.

## ROTTERMOND

CUSTOM JEWELERS

369 N. Main, Milford

810•685•1150

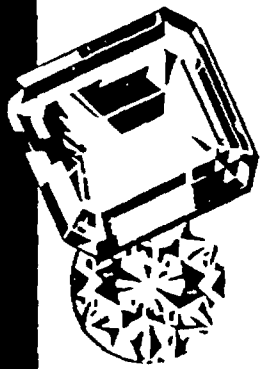



# Happy Holidays

from

the entire staff of:

# VISIONS Salon



*our business is focusing on you!*

**Our salon cares for your total beauty:  
Hair, nails, skin and body.**

*We have Great Ideas for your Holiday Shopping. We offer a wide range of products, from aroma therapy candles, bath oils, make-up, skin care and professional hair care products to fill your stockings*



## Give a Gift of pampering

Call 344-9944 to select the perfect day package. A relaxing day of the most luxurious pampering is waiting for your special someone.

**\*Hair Designs**

- Designer Cuts
- Perms
- Color
- Special Occasion Style

**\*Nails**

- Whirlpool pedicures
- Acrylics - Gel, Wraps
- Paraffin
- Nail Art

**\*Massage**

- Therapeutic
- Swedish
- Sports
- Shiatsu
- Polarity
- Reflexology
- PreNatal

**\*Facials**

- Deep Cleansing
- Acne Prone
- Eye Firming
- Moisture Replacement
- Glycolique Treatments

**\*Makeup**

**\*Waxing**

**\*Electrolysis**

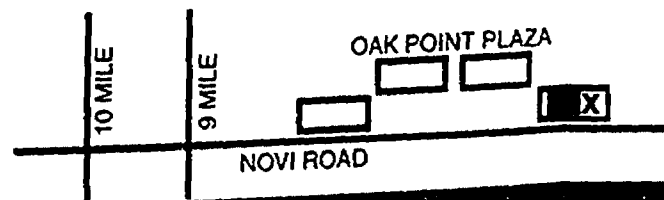

## 810 344-9944

2202 Novi Road  
Novi, Mich 48375  
(Oak Point Plaza)

# Potlucks are a perfect way to entertain

By Priscilla Lister  
Copley News Service

"Like old-fashioned church suppers, communal dinners are coming into their own again," says Marion Cunningham in the new edition of the classic cookbook, "The Fannie Farmer Cookbook" (Knopf), revised for the '90s. "It's a good way for working people, who might not otherwise have the time, to put together a festive dinner. And if everyone chips in, the financial burden is shared."

Potluck parties can especially fill the bill during December. Whether it's a gathering of co-workers during a holiday lunch at the office, a celebration of neighbors at the new year, a Kwanzaa or Hanukkah or Christmas feast for an extended family, or a party among friends, make it potluck. Everyone shares in the giving, which really can make everyone happier.

Cunningham suggests that for a potluck dinner, it's "wise to have someone coordinate the meal so that everything goes together well." Or the meal could be coordinated with plenty of creative leeway, such as simply assigning courses.

For some potluck parties, no specific assignments are necessary. Consider a cookie exchange, where each person brings a dozen or more cookies to share and exchange. Or a cocktail buffet, where everyone brings his or her own favorite finger food. Or a salad bar, where everyone brings a prepared salad. Or a pizza party where everyone brings the ingredients for their favorite toppings.

The potluck possibilities are virtually as endless as food choices. But there are certain considerations that can make potluck parties more successful.

The editors and writers of *Sunset* magazine offer some good seasonal entertaining ideas for potlucks in "Sunset Recipe Annual, 1995 Edition" (Sunset Publishing).

"When we gather families and friends to share the season's festivities, it's their company we want to enjoy. We choose and serve foods that will make friends comfortable, get them involved, break the ice and reaffirm traditions," say the editors.

Jerry Anne Di Vecchio, a *Sunset* writer, says for a dish to make it onto her party menu, it has "to meet some tough standards, especially for the come-and-go gathering we particularly enjoy." Her primary criteria: foods that stay fresh for hours, are self-serve, can be eaten with fingers and require no



A cookie exchange lets everyone show off their best holiday recipes.

last-minute attention.

To get your juices flowing, here are some general ideas for great potluck dishes:

Any bruschetta or crostini, the crispy Italian bread appetizers topped with chopped tomatoes and fresh basil or tapenade, an olive paste; any quiche or frittata, cut into bite-size pieces; any number of chips and dips, from fresh veggies with hummus to corn tortilla crisps with salsas; a selection of fresh fruits, cut into chunks or wedges; cold shrimp with cocktail sauce; baked chicken fingers; egg rolls with spicy peanut sauce; any cold soup, from vichyssoise to gazpacho; three-bean

salad, spicy corn and rice salad or tabbouleh; flour tortilla roll-ups (spread with cream cheese, spicy bean dip, diced green onions, cilantro and such additions as diced red peppers, diced ham or bacon, rolled up, then cut into bite-size pieces); tiny crab cakes.

Bring your favorite casseroles, especially those that don't suffer too much if they're not piping hot: Macaroni and Cheese; Spaghetti Casserole; Cheesy Broccoli and Rice; Baked Beans; Chicken Noodle Casserole.

And you can never go wrong with bringing sweets of any kind, from tarts, cakes, cookies or brownies to homemade nut brittles or fudge.

Take one of these dishes to your next potluck, and you'll surely please a holiday crowd.

## TEXAS TORTILLA BAKE

1-1/2 pounds lean ground beef  
1 large onion, chopped  
1 (14-1/2 -ounce) can Mexican-style stewed tomatoes, undrained  
1 (10-ounce) can mild enchilada sauce  
8 ounces process cheese spread, sliced  
2 teaspoons ground cumin  
1/2 teaspoon salt  
1/2 teaspoon pepper  
2 cups crushed tortilla chips  
1 (3-ounce) package cream cheese  
8 (8-inch) flour tortillas  
1 (4-1/2 -ounce) can chopped green chilies  
1 cup (4 ounces) Monterey Jack cheese, shredded  
Yields 8 servings.

Brown ground beef and onion in large skillet or Dutch oven, stirring until meat crumbles. Drain.

Stir in tomatoes, enchilada sauce, sliced cheese spread, cumin, salt and pepper; cook mixture over low heat, stirring constantly, until cheese melts. Set aside.

Preheat oven to 350 F.

Place crushed tortilla chips in greased 13x9x2-inch baking dish (or disposable aluminum foil pan). Spoon two-thirds of beef mixture over tortilla chips.

Spread cream cheese evenly on 1 side of tortillas, and sprinkle evenly with chilies. Fold tortillas in half and arrange on beef mixture. Spoon remaining beef mixture on top of tortillas, and cover.

Bake for 20 minutes. Uncover casserole and sprinkle with Monterey Jack cheese. Bake 5 additional minutes to melt cheese.

From *Southern Living: 1994 Annual Recipes* (Oxmoor House).

## SICILIAN PASTA TIMBALE

2 small (about 1 pound each) eggplants  
About 2 teaspoons salt  
4 to 6 tablespoons olive oil  
1 pound salad macaroni  
3 cups marinara sauce, homemade or purchased  
2 cups shredded provolone cheese  
1/2 cup grated Romano cheese (divided use)



**20% off all size  
STREAM BATH**

in stock with this ad  
expires 12-11-96

Let your  
bathtub double  
as a steam  
room!



**South Lyon Plumbing & Supply**  
(810) 486-1288  
21001 Pontiac Trail (just north of 8 Mile)

**\$anta'surplus®**  
TOY & GIFT OUTLET STORE

**WEST OAKS II  
SHOPPING CENTER**  
(next to Toys 'R Us)  
43484 W. Oaks Drive • Novi  
810-344-1153  
Mon - Sat 10-9; Sun. 12-5

SHOP EARLY WHILE QUANTITIES LAST.

**SHAPED BOOKS.**  
Choose from animal and  
vehicle themes.  
Just right for preschoolers.  
Coated paper.  
RETAIL VALUE: \$3.95  
NOW **\$1.49** EACH



**RIBBON EGGS.**  
Choose from various  
colors of curling ribbon.  
Each contains 60 feet.  
RETAIL VALUE: \$.49  
NOW **29¢** EACH



**BLITZEN!**  
**SAVE 25%-70%**  
You may win a \$50  
SHOPPING SPREE!  
And Register for a  
HAWAIIAN HOLIDAY FOR TWO.



**Open  
Nov.  
30th**

**Christmas Trees**

Scotch Pine 5½' - 8'  
your choice tax included **\$14.00** Larger Trees Available

Colorado Spruce & Douglas Fir Available  
Sold at:

**Erwin's Country Store**  
Pontiac Trail & Silver Lake Rd.  
**Normar Tree Farms**  
12744 Silver Lake Rd. • Brighton  
(810) 437-1202  
Hours: 4pm-6pm Weekdays; Sat. & Sun. 9am-6pm



**Make It A Special Christmas . . .  
Take A DRIVE IN THE COUNTRY**

Experience the holiday fun and adventure of a 400 year tradition, searching for the world's greatest Christmas Tree . . . and be enchanted with a HORSE DRAWN WAGON RIDE around our lake on a scenic 75 acre tree plantation . . .

**CHRISTMAS TREES**  
Choose And Cut Your Own  
• Blue Spruce • Pine •  
(Saws Provided • Trees Machine Cleaned)

\*Tree Sizes - Table Top to 12 Ft. \*Hot Beverages & Foods  
\*Selection - Over 60,000 \*Country Crafts, Tree Stands, Etc. . .  
\*Priced \$5 and up \*Children's Elf Tunnel  
\*Santa Claus \*Pony Rides \*Petting Zoo

**\$200 OFF**  
Any 5 1/2 to 7 ft  
TREE  
WITH THIS AD

15 minutes south of I-96 at  
Fowlerville. 20 minutes north of I-94 at Chelsea

**SKYHORSE  
STATION**  
11000 Roberts Rd., Stockbridge  
(517) 851-7017  
9 til Dark Everyday

Call toll free  
for information  
and directions **1-800-497-2682**



*Holiday* Gifts from **PFAFF**

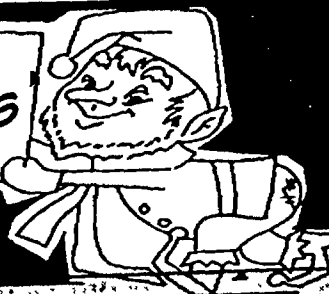

**#1:** Pfaff tipmatic 6085  
21 Stitches plus buttonhole, blind hem with case  
Reg. \$799  
Sale Price \$499

**#2:** Pfaff tipmatic 6122  
21 Stitches plus buttonhole  
Reg. \$1199  
Sale Price \$899

**#3:** Pfaff tipmatic 6091  
21 stitches, plus buttonhole, blind hem, with case plus Pfaff exclusive dual feed.  
Reg. \$999  
Sale Price \$699

**FAST CREATIVE**  
Pfaff tipmatic 7570  
World's finest computerized sewing machine working with the most advanced embroidery hoop system any where  
Reg. \$4499  
Sale Price \$3399

**Anderson Sew 'n Vac**  
34170 PLYMOUTH ROAD • LIVONIA  
(between Wayne and Farmington)  
Extended Holiday Hours: M - F 10-5 Th 11-7 Sat: 10-4

**Open an Adventure**

Give the gift of a lifetime . . .  
a champagne hot air balloon flight!

**renaissance balloons, inc.**  
1255 E. Grand River Avenue  
Brighton, Michigan 48116  
(810) 229-7400

Ask about  
our  
Holiday  
Special!

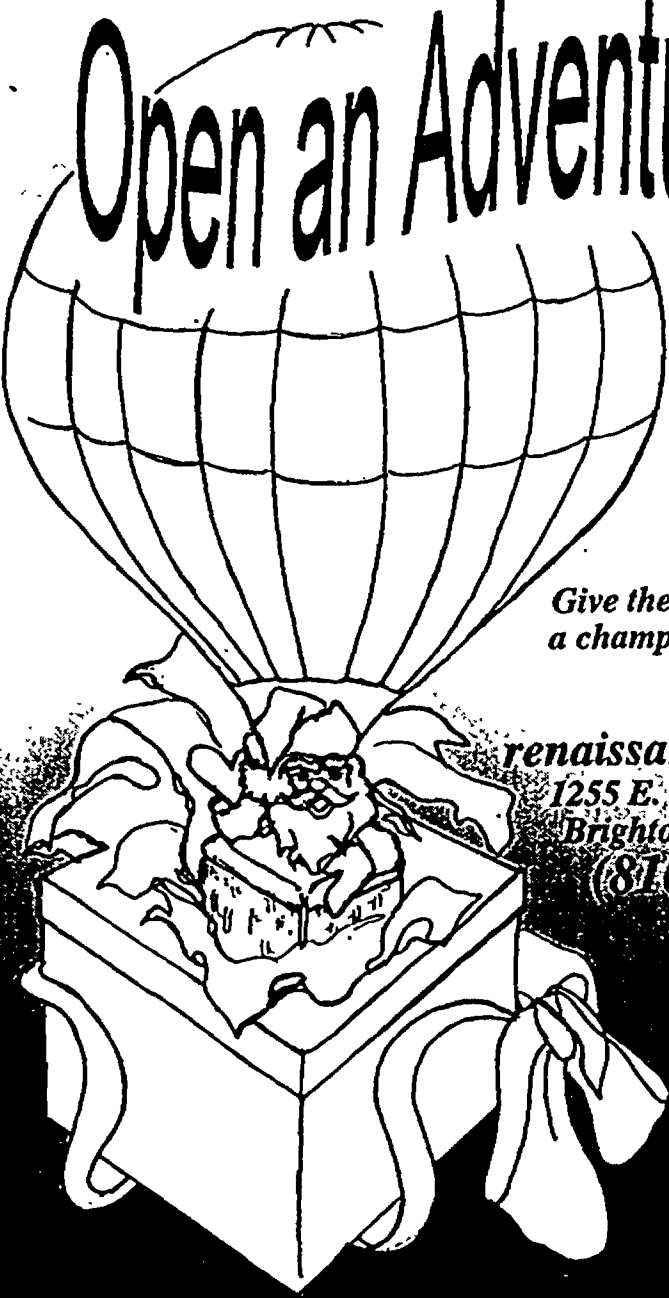

# Cards should reflect the sender's sentiments

By Elizabeth Scheibner  
Copley News Service

During the period between Thanksgiving and the end of the year, more than 2.65 billion holiday cards will be exchanged in homes across the United States. And, as any weary, overworked postal employee will tell you, that's a lot of mail.

Whether you make your own or buy them, sending cards is a holiday tradition that is here to stay - even in the age of e-mail and the Internet. In many cases, holiday cards are our only correspondence with long-distance friends and relatives.

Choosing your holiday cards can either be a frustrating or enjoyable experience, depending on how you approach it.

The key is to shop early when the selection is at its best and you're not rushed. Look for cards that express your feelings and your personality, whether it's spiritual, joyous or humorous. You may want to buy several different styles of cards to complement the unique personalities of your friends and loved ones.

More than three-fourths of all households include family photographs in their cards or use a photo on the front of the card. The range of photo-holder cards has grown enormously in the last few years, reflecting better quality and better design. Choose from whimsical to sophisticated, contemporary to traditional.

If you're going to have a professional photographer take your holiday photo, be sure to schedule the shoot early in the season.

Photographers are busy during the holidays and are often booked weeks or months in advance. You also need to allow enough time to select proofs and have reprints made.

In today's hectic lifestyle, many people don't have the time to write long personalized letters to each person on their holiday card list. Instead, they write a generic letter highlighting what they've done over the past year and have it photocopied. While some people may view this as tacky, it's becoming more and more accepted. If you go this route, make sure to include

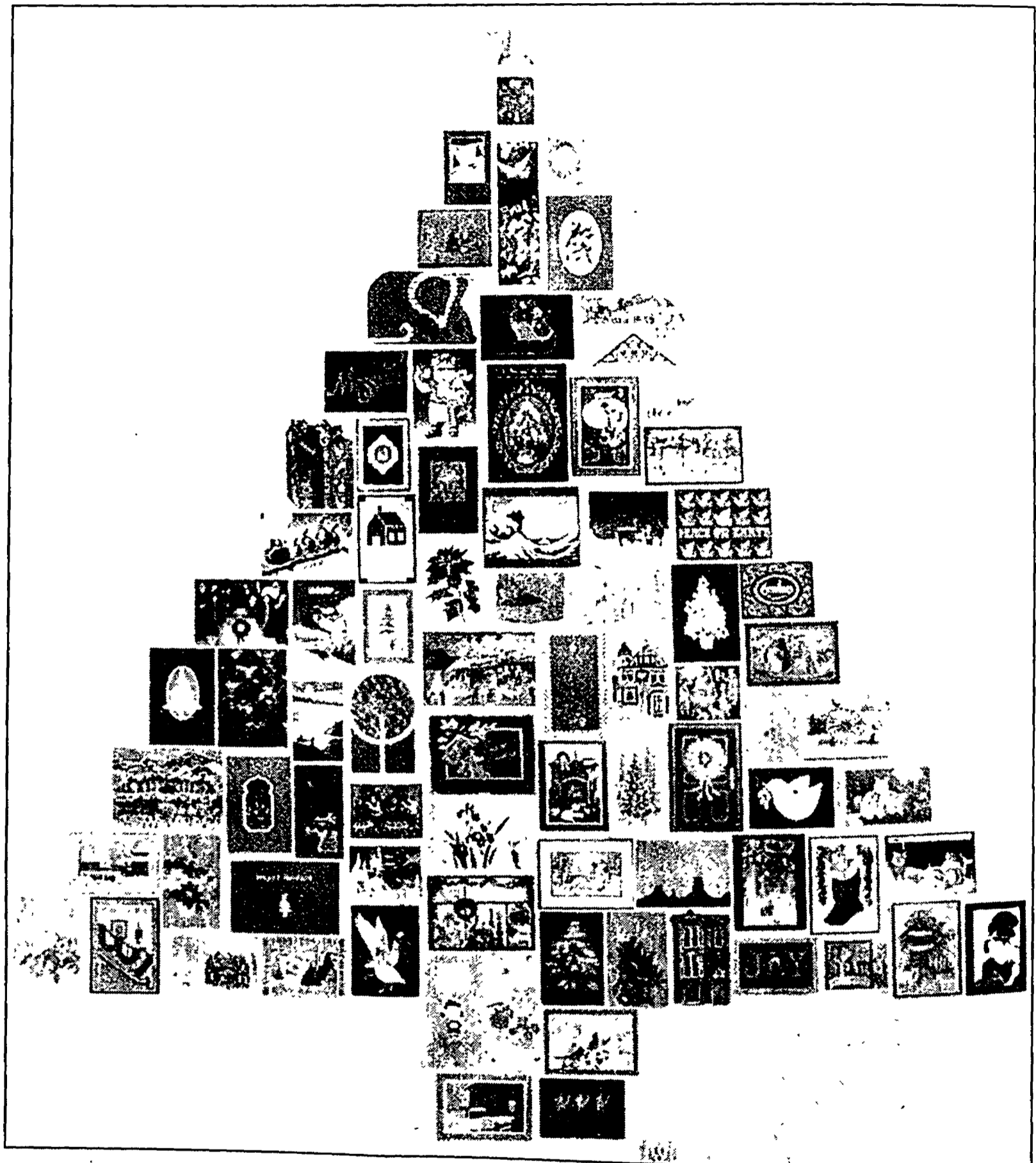

Wondering what to do with all those pretty greeting cards that come in the mail? Try displaying them on the wall in an appropriate pattern.

a personalized note to each recipient at the end of the letter. And remember to keep the letter brief. No one needs to hear about all your dental problems or

the scores from your son's soccer games.

Making your own holiday card is a great way to personalize your holiday

greetings. And you don't have to be a promising artist or a budding poet to

Continued on 12

## CARD DESIGNS

The following are top design trends in holiday cards:

**Arctic animals:** featuring illustrations or photographs of polar bears, wolves, penguins, seals and reindeer in snowy settings.

**Regional:** cards with regional images or humor for different parts of the country.

**Ethnic:** multicultural cards with African folk art, American Indian themes and Hispanic influences.

**Nautical:** featuring seascapes,

sailboats, frigates and lighthouses.

**Spiritual:** religious and inspirational cards offering messages of renewal, hope and peace.

**Victorian:** nostalgic cards featuring Victorian angels, Dickens

village scenes and Old World Santas.

**Celestial:** contemporary cards with stars, moons and suns.

(Source: American Greetings and Hallmark.)

# Gift-giving tips for co-workers and clients

By John Godfrey  
Copley News Service

Ever since Ebenezer Scrooge discovered the true meaning of Christmas and decided to pop for the Cratchit family holiday dinner, the business world has recognized the marketing value of the yuletide season.

Whether you're running a multinational corporation or working at home for yourself, you can make a big impression with a well-thought-out holiday gift or two. Of course, not all impressions are good: Something tasteful and elegant will remind everyone of your best qualities; a tacky trinket might make them think twice about doing business with you.

## IN THE WORKPLACE

Delia Marshall, senior editor of Smart Money magazine, writes a monthly column on gift giving. She said that business gift giving is rife with complications and caveats, and the boss-secretary relationship can get

particularly treacherous around the holidays.

"I think a lot of bosses agonize over what to give their secretaries because you don't want to be too personal, but you don't want to be too impersonal," Marshall said. "You want to keep them happy because a good secretary is priceless."

The trick, she said, is to find something personal but not intimate.

"Give them something slightly extravagant they wouldn't get for themselves, like a brand-name item from Tiffany's or a store like that. Articles of clothing are risky because of the fit issue and also because they'll feel compelled to wear it."

Although cost shouldn't be the issue, Marshall said that a high-ranking executive should be willing to pay \$50 to \$100 on a secretary's gift. A midlevel executive would do fine to spend in the \$25 to \$50 range.

"If you can get the perfect thing for \$5, great," she added. "An obscure recording with a story behind it is

great, and that will only cost you \$15."

Many companies have instituted "Secret Santa" gift-giving programs so no one feels obliged to buy presents for everyone in the building.

With this approach, participants draw a name out of a hat and are "assigned" to give that person a gift, usually something with a strict price limit.

This is a great way to get everyone into the holiday spirit without breaking the bank. Trying to figure out who your Santa is can be more fun than opening the gift.

Employers who want to give some sort of gift to the entire staff should be careful to give staffers something useful and tasteful. If you give your workers something chintzy or self-promotional, they'll talk about it for months.

Marshall, for one, thinks promotional gifts to employees are "pretty tacky."

"The only point for an employee gift is to thank them and to reaffirm your relationship with them," Marshall said. "You don't have to remind them who you are. One hopes they know."

Marshall's favorite gift from a boss? "I got a blanket one year. A wool throw. You can never have too many of those. It was just a beautiful, woven, green throw, and it didn't have any logo on it."

## GIFTS FOR CLIENTS

If sending a logo-imprinted gift is tacky for employees, it's sometimes necessary when dealing with clients.

"For clients," Marshall said, "the most tasteful thing to do is not to include your logo. If you're talking about marketing, though, taste isn't always the issue."

According to Lea Manning, research administrator for Promotional Products Association International, the trade association for the promotional products industry, logo-imprinted gifts were an \$8 billion industry last year. Not surprisingly, the holidays are the busiest time of the year.

More companies are realizing the

Continued on 34

DESIGN AND EXPERT CRAFTSMANSHIP AT OLD FASHIONED PRICES

**The YANKEE CARPENTER**

UNFINISHED & FINISHED FURNITURE • CUSTOM FINISHING STAIN OR PAINT

**KHOURY**

Real wood for real life . . .

**SALE \$144<sup>95</sup>**

**THE LOW PRICE LEADERS!**

**SALE \$239<sup>95</sup>**

**SALE \$119<sup>95</sup>**

**90 DAYS SAME AS CASH**

Bring in this ad for additional savings on other Khoury items!

Qualified Buyers Get Up To \$10,000 Credit With This Card

WE'LL MATCH ANY ADVERTISED PRICE!

YOU WON'T GO NAKED BUYING AT THE YANKEE!

NEW LOCATION IN BRIGHTON  
8671 W. Grand River at I-96  
(810) 227-3434  
Hours: Mon.-Thurs., Fri. 10-8  
Tues. - Wed. 10-6  
Sat. 10-5 • Sun. 12-4  
or visit our 2 other locations-

**BLOOMFIELD HILLS**  
1751 S. Telegraph  
(313) 338-0441

**STERLING HEIGHTS**  
43775 Van Dyke  
(313) 739-2323

MEMBER AGS AMERICAN GEM SOCIETY

ON THESE SELECTED DAYS ONLY

**Orin Jewelers INC.**

SINCE 1933

For the finest in  
• DIAMONDS  
• PRECIOUS GEMS  
• GOLD JEWELRY  
• FINE WATCHES

Make This Christmas Special  
With a Lasting Gift from Orin Jewelers

DIAMOND AND COLORED GEM ADD-A-LINK BRACELETS  
Starting from \$160<sup>00</sup>

Dazzle Her With Diamonds  
Anniversary rings beautifully set with diamonds alone or with a mix of diamond, rubies, sapphires or emeralds.  
Starting From \$275

Mikimoto. Where Culture Began.  
Cultured pearl necklaces in varying sizes and lengths, all featuring Mikimoto's signature 18k gold clasp.

the Steel Series Water-Resistant to 200 meters  
TAGHeuer

"Your Family Diamond Store..  
Where Fine Quality & Service are Affordable"

**90 DAY FREE FINANCING!**  
with approved credit

GARDEN CITY  
29317 Ford Road (at Middlebelt)  
(313) 422-7030

NORTHVILLE  
101 East Main (at Center)  
(810) 349-6910

MEMBER AGS AMERICAN GEM SOCIETY

Orin Jewelers Charge Select Purchase Charge

CELEBRATED GEMOLOGIST AMERICAN GEM SOCIETY

# Hints for choosing the perfect holiday tree

By Jennifer Plantier  
Copley News Service

For many families, a fabulous tree is the centerpiece of holiday home decorating, and an important symbol of joyous seasons past and present. Even though most of us have too much to do and too little free time during the holidays, try to think of tree shopping and trimming as a fun family outing and not just one more daunting task to be completed.

Fresh or artificial? The debate rages on in many households. Our preferences seem to be formed by dear childhood memories of searching for the perfect evergreen - or frightening flashbacks of the unholy mess they can leave behind.

It's no secret, opting for an artificial tree is more convenient, less messy and more economical over the long run.

And these days you don't have to sacrifice good looks. A high-end quality tree looks almost as real as those from the great outdoors - complete with cute little pine cones.

For others, however, the trip to the tree lot is part of the holiday experience and no amount of convenience can replace the good feelings inspired by the heady aroma of a fresh-cut tree.

## FRESH AND FRAGRANT

Those who set out to find the perfect tree should remember that the fresher the tree is to begin with, the fewer problems they will encounter later. Look for brightly colored, pliable (as opposed to brittle) and lush needles - telltale signs that trees are cut fresh, rather than chopped down and stored months in advance.

Whether you purchase your tree directly from a tree farm, a corner lot or other retail store, make sure that the trees



A fancy tree laden with gold balls, ribbons and other finery makes an eye-catching seasonal decoration.

are displayed on raised platforms as opposed to pavement and are kept well watered and out of direct sunlight.

When selecting a particular tree, consider your ceiling height and the amount of space you have to display the

tree. Generally, people find full, symmetrical trees most attractive, so step back and circle the tree, looking for bare spots and assessing its overall appeal. The trunk should also be straight enough to stand upright in a stand. Keep in mind that even the most beautiful, natural

trees will not be perfect!

Following is a rundown of some of the most popular varieties of Christmas trees. Personal taste and your decorating style will determine the right one for you. Also,

## TREE THEMES

By Jennifer Plantier  
Copley News Service

Many take pride in a hodgepodge holiday tree, trimmed by the entire family with ornaments that become more cherished with each year. Others take the decorating more seriously - elevating it to a medium of artistic expression and putting lots of thought into elements of color and theme. Whatever your approach, it should be a project the family can enjoy together.

Start with a tree set up sturdily in a stand. Wrap a sheet or decorative tree skirt around the bottom, and begin by stringing the light strands first from bottom to top. Continue with strands of beads or garland before placing ornaments. Heavier ornaments may need to be placed back toward the trunk and on heavier branches, while lighter ones will work toward the ends.

Following are a few examples of attractive themes, but remember that the possibilities are virtually endless.

**Chosen colors.** Pick a color scheme (all gold, white Christmas, pastels, etc.), and go with lights, ornaments, ribbon and other trim that match for a striking effect.

**Back to nature.** Choose ornaments depicting nature or made of natural materials. Trim with flowers and plants (real or otherwise), string cranberries together in strands.

**Nostalgia.** Search out ornaments that recall previous eras like Victorian angels, candle lamps or old-fashioned Santas.

**Folk art/handcrafted designs.** Look for handmade goods at holiday fairs and craft shows. Better yet, look to craft magazines for ornaments you can make yourself.

**Favorite things.** Load up a tree with teddy bears, angels or any one thing you really adore.

**Campy collections.** Look for companies such as Hallmark for wonderful collector ornaments in lots of styles. Many newer styles depict sports celebrities, cartoon figures and elements of pop culture, such as Barbie. Some even have moving parts that are powered by plugging them into light strands.

# DONNA'S BOOKSTOP has...

Something For everyone on your list!

- Book Lights • Cliff Notes
- Books On Tape
- Stocking Stuffers
- Romantic Times
- Goosebumps
- ... BOOKS! BOOKS! BOOKS!

Christmas Book  
Orders by  
December  
16th

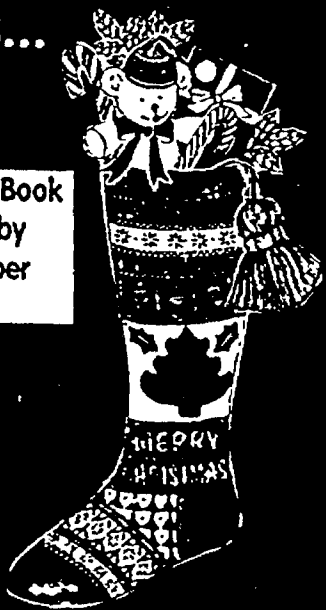

Extended Holiday Hours:  
Sundays (through Dec. 22nd) - 9 a.m. to 3 p.m.  
and  
Thursdays (starting Dec. 5th) - until 7 p.m.

1419 S. Milford Rd., Highland  
next to D' Cafe in Colonial Village  
(810) 887-8383

Hours:  
Mon.-Fri. 10-6  
Sat. 9-5

Happy Holidays From All Of Us At Donna's Book Stop!



## DEADLY NEUROMUSCULAR DISEASES

Please help us put on  
the brakes.

**MDA**  
Muscular Dystrophy Association  
1-800-572-1717

People help MDA. because MDA helps people

SUNSHINE FARM and GARDEN  
Invites you to our  
"Just in Thyme  
for Your Holidays"!

# OPEN HOUSE

on  
FRIDAY, SATURDAY & SUNDAY  
NOVEMBER 29, 30 & DECEMBER 1

**FREE Refreshments** "MAKE IT AND TAKE IT  
WORKSHOPS"  
**FREE Demonstrations**  
Your Choice \$10<sup>00</sup> ea.

Call For  
Workshop  
Times!

- Flower Pot Angel • Good Luck Bird's Nest
- Pressed Flower Picture • Mini-Topiary
- Cinnamon Stick Ornaments • Potpourri Jar
- Silk Evergreen Wreath • Manger Herbs
- Bible Potpourri for Christmas

Call For  
Workshop  
Times!

The Herb Shop is filled to the Brim with Herbal Gifts, common and rare dried Herbs and Flowers, Herbal and Botanical Wreaths, Swags, Centerpieces, Books, Baskets, Windowsill Herb Pots, Garden Statuary, Potpourri Ingredients, Fragrance and Essential Oils, and many, many more Beautiful Things for the Holiday Season.

## SUNSHINE FARM AND GARDEN

2460 WIXOM ROAD

COMMERCE TOWNSHIP, MICHIGAN 48382

PHONE AND FAX (810) 685-2204

Hours: Tuesday thru Saturday, 10 a.m. to 5 p.m., April thru December.

Call for complete class lists.

# Give GOLF!

THE PERFECT HOLIDAY GIFT  
FOR ANY GOLFER!

Give this great golf and dining special for any one of the featured courses.  
Worth over \$200.00 each! Valid through 1997.

Only **\$25.00** per certificate

Each certificate entitles you or your guest to complimentary golf and dining  
when a second of equal or greater value is purchased.

Choose from:

- \* **WHISPERING PINES** - Pinckney  
5 FREE ROUNDS OF GOLF AND 1 FREE BONUS 9 HOLE ROUND
- \* **RUSH LAKE** - Pinckney / **REDDEMAN FARMS 'COMBO CARD'**  
5 FREE ROUNDS OF GOLF AT EACH COURSE & 5 FREE LUNCH OR DINNERS
- \* **BRENTWOOD** - White Lake  
5 FREE ROUNDS OF GOLF, 5 FREE LUNCHES & 5 FREE DINNERS
- \* **HICKORY CREEK** - Canton  
5 FREE ROUNDS OF GOLF & FIVE FREE BUCKETS OF BALLS
- \* **CAPTAIN'S CLUB** - Grand Blanc (just off I-75) - a Raymond Floyd course.  
5 FREE ROUNDS OF GOLF, 5 FREE LUNCHES & 5 FREE DINNERS
- \* **REDDEMAN FARMS** - Chelsea (just W. of Ann Arbor)  
5 FREE ROUNDS OF GOLF, 5 FREE LUNCHES & 5 FREE DINNERS
- \* **HIGHLAND HILLS** - Highland  
5 FREE 18 HOLE & 5 FREE 9 HOLE ROUNDS OF GOLF & 5 FREE LUNCHES

Call (810) 669-8815 or (800) 838-5294

or send check or money order to  
Dickenson Sawyer, Inc.  
P.O. Box 396, Milford, MI 48381

Please specify which certificate you wish to order!  
Certificates are not available at the course.



GUARANTEED LOWEST  
PRICES OF THE YEAR!

# 14KT GOLD

At Unbelievable Savings  
14KT ITALIAN GOLD CHAINS & BRACELETS



**\$12.95**  
PER GRAM

Not a limited  
selection  
but **Hundreds** to  
choose from

ALL  
DIAMOND  
& GEMSTONE  
JEWELRY  
30-50% OFF

- Custom Rings & Remounts Our Specialty
- Citizen & Seiko Watches 30-60% OFF

*Redford Jewelry*

25950 W. Six Mile  
Redford Twp.  
(2 BLOCKS WEST OF BEECH DALY)  
(313) 592-8119

HOURS:  
MON.-SAT.....10-6  
THURS.....10-8  
INSTANT CREDIT AVAILABLE

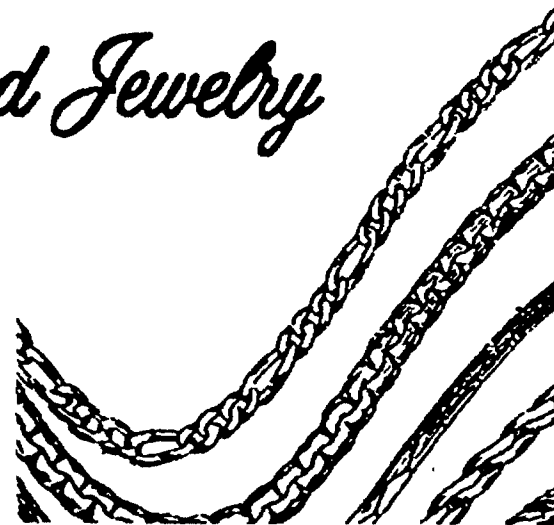



- Woven throws
- Wreaths
- Pilgrim & Blenko glass
- Architectural accents
- Lamps
- Pillows & Bell pulls
- Jewelry
- Christmas ornaments, cards & wrappings
- Candles
- Boyd collectibles
- Unique gifts & Home decor

Extended holiday hours

**Traditions**  
Ltd.

120 N. Center • Northville  
(810) 349-0199

**GIVE SOMEONE SPECIAL  
(or yourself) SOMETHING  
DIFFERENT THIS CHRISTMAS**



31060 Wixom Rd.

Wixom, MI 48393

**GOLD'S GYM AND  
FITNESS**

**CENTER OF WIXOM**

MAKES GIFT GIVING EASY WITH THESE  
GREAT END-OF-THE-YEAR SPECIALS:

90 DAY MEMBERSHIPS  
(regularly \$125.00)  
**HOLIDAY PRICED**  
\$99.00

6 MONTH MEMBERSHIPS  
(regularly \$199.00)  
**HOLIDAY PRICED**  
\$175.00

YEARLY MEMBERSHIPS  
AS LOW AS  
**\$30.00 A MONTH**  
(with no sign-up fee, regularly \$25.00)

**25% OFF**  
ALL CLOTHES AND ACCESSORIES

GIFT CERTIFICATES AVAILABLE

AND AS ALWAYS...  
DAILY RATES ARE 1/2 PRICE BEFORE 3 P.M.

HOURS ARE:  
MON. - FRI. 5 A.M. - 11 P.M.  
SAT. - SUN. 8 A.M. - 6 P.M.  
PHONE: (810) 960-7766

ASK ABOUT OUR CORPORATE AND  
SENIOR CITIZEN DISCOUNTS

A Licensee of Gold's Gym Enterprises, Inc. • Sale Ends 12/31/96

Present this flyer for a complimentary  
**\$25**  
**VALUE**  
session with a personal trainer.



**GOLD'S GYM IS PLEASED TO OFFER  
THESE AMENITIES:**  
Clean, spacious locker rooms • Personal trainers  
• Babysitting • Tanning  
Friendly, knowledgeable staff • Juice bar • Pro shop  
Tons of free-weights  
State-of-the-art equipment  
Extensive cardio section with televisions



# Wreaths are an easy project

By Elizabeth Scheibner  
Copy News Service

Most of us go to great lengths to decorate the inside of our homes during the holidays, but we often neglect the outside. Hanging a wreath on your front door makes your house more inviting and announces to passers-by that you're in the holiday spirit.

One of the delightful things about wreath-making is that it allows complete freedom of expression. You can create a holiday wreath that expresses your own style - whether it's sophisticated, whimsical or traditional. Don't feel you must imitate something you've seen at a store. Be creative and have fun. Experiment with different materials and decorations. When it comes to wreath-making, there are no rules.

Unlike some crafts that require a sizable investment in supplies and materials, wreath-making is



Creating a homemade wreath is a satisfying holiday project. On this wreath, dried flowers and other plants accent a eucalyptus base.

Continued on 14

## Come share the magic of Christmas!

### Great Gift & Decorating Ideas

- The Boyds Collection (Bearstone, Folkstone, Dollstone, Plush)
- Woolys (The original Wooly Snowman)
- Lang Calendars
- Pine Baroness Angels & Dolls
- Camille Beckman
- Pat Richter - Prints & Cards
- Accent Furniture Pieces
- Village Candles
- Snowmen - Angels - Gingerbread

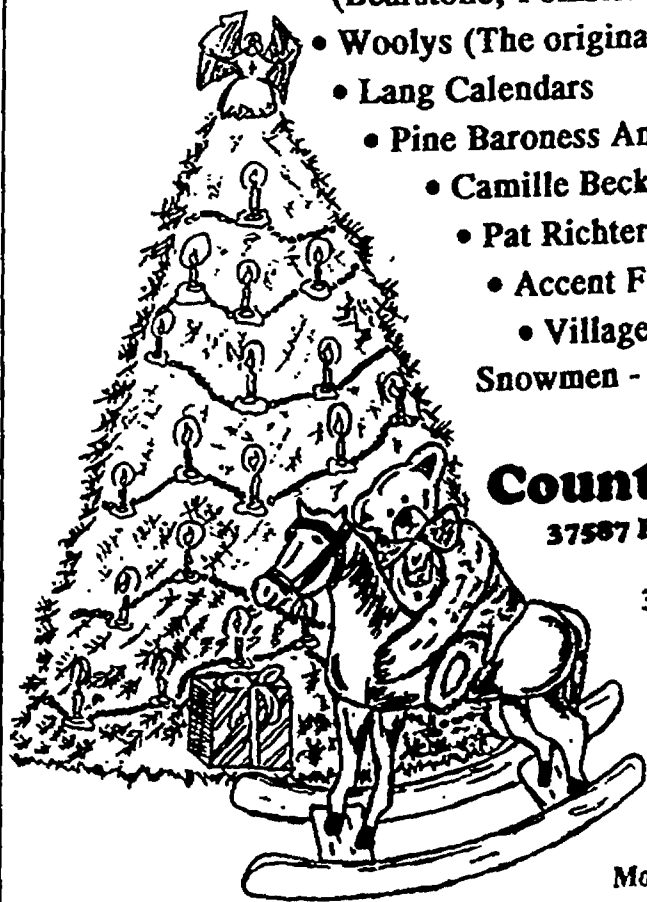

### Country Elegance

37587 Five Mile at Newburgh  
Livonia, MI  
313-953-9687

Experience peaceful,  
friendly Holiday  
Shopping.

Holiday Hours:  
Mon-Fri 10-8, Sat 10-6, Sun 12-5

21130

## Remember Us...



...for your Holiday Shopping!

Looking for an extra special item for someone very dear? Our expanded store is brimming with gift ideas...come see for yourself.

Rockers • Cedar Chests  
Entertainment Centers  
Recliners • Curios and more

Quality - Value  
Price  
427-3080

**Chris Furniture**

Sheldon Center  
33125 Plymouth Rd.  
Corner of Plymouth & Farmington Rds.  
Livonia

Open: M&F 9:30-9; T,W,Th&Sat. 9:30-6; Sun. 12-5



21132

# Communal dining is becoming popular again

Continued from 4

Butter, to prepare pan  
2 tablespoons fine dry bread crumbs  
Fresh basil sprigs (optional)  
Yields 8 servings.

Trim stems from eggplants, then cut lengthwise into 1/4-inch-thick slices; sprinkle with salt. Let stand 15 minutes. Rinse; pat dry.

Preheat oven to 425 F. Coat 2 or 3 pans, each 10 by 15 inches, with 2 tablespoons oil each. Turn eggplant slices in oil, arrange in single layer.

Bake until eggplant is browned and soft when pressed, 15 to 25 minutes; remove as browned.

Meanwhile, bring about 3 quarts water to a boil in 5- to 6-quart saucepan. Add macaroni and cook just until barely tender to bite, 5 to 6 minutes. Drain. Mix macaroni with 2 cups marinara sauce, provolone cheese and 6 tablespoons Romano cheese.

Butter sides and bottom of 9-inch cheesecake pan with removable rim. Dust pan with bread crumbs. Arrange one-third of eggplant slices, overlapping to cover bottom of pan. Cover with half of macaroni mixture. Repeat layers; arrange eggplant to cover top layer. Press down gently to compact layers and make timbale level. Sprinkle with remaining Romano cheese. (Can be made ahead, covered and chilled up to 1 day.)

Bake, uncovered, in 350-F oven until hot in center, about 30 minutes (bake chilled timbale for 30 minutes, then uncover and continue baking until hot in center, about 30 minutes longer). Let

## YULEFACTS

### Holiday headaches

These common yuletide foods are known to trigger headaches in some people:

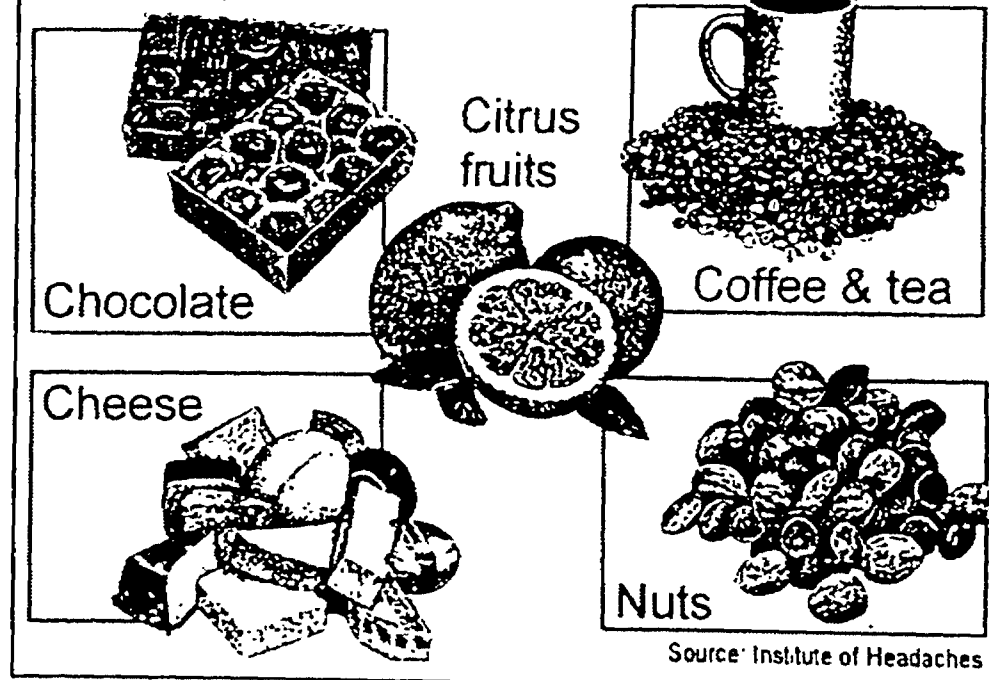

Source: Institute of Headaches

stand 5 minutes.

In 1- to 1-1/2 -quart pan, stir remaining sauce over medium heat until hot.

With knife, cut around timbale to release; remove pan rim. Garnish timbale with basil. Cut into wedges, Serve with sauce.

From *Sunset Recipe Annual, 1995 Edition* (Sunset Publishing).

These cookies, made without flour,

egg yolks or shortening (except to grease pans), are as moist as candy.

### COCONUT-ALMOND MACAROONS

3-1/2 cups (14 ounces) sweetened, flaked coconut (divided use)

1 cup sliced almonds

1/2 cup (4 fluid ounces) sweetened condensed milk

1/2 teaspoon almond extract (essence)

2 egg whites

1 tablespoon sugar

Pinch of salt

Warm, melted, bittersweet chocolate (optional)

Yields about 18 cookies.

Position rack in middle of oven and preheat to 350 F. Grease 2 large baking sheets with solid vegetable shortening.

In baking pan, combine 1-1/2 cups of coconut and almonds. Bake, stirring occasionally, until golden, about 12 minutes. Remove from oven; cool. Leave oven set at 350 F.

In large bowl, combine cooled coconut mixture, remaining 2 cups coconut, condensed milk and almond extract. In another large bowl, using electric mixer set on high speed, beat together egg whites, sugar and salt until soft peaks form. Using rubber spatula, gently fold egg whites into coconut mixture.

Using large spoon, form mounds 2 inches in diameter on prepared sheets, spacing them 2 inches apart. Bake until cookies are golden brown, about 10 minutes. Transfer to racks and cool completely.

Line 2 baking sheets with wax paper. Dip bottoms of cookies into melted chocolate and transfer chocolate-side down to prepared baking sheets. Refrigerate until chocolate is set. Store cookies in airtight containers at room temperature for up to 4 days.

From Williams-Sonoma Holiday Baking (Time-Life Books).

# Sending cards is a holiday tradition that's here to stay

Continued from 6

create effective cards and messages.

A little imagination goes a long way. If you're at a loss for ideas, take a card-making class offered by a local crafts store or community college.

The options for making holiday cards are virtually endless. You can create designs with potato prints, linoleum blocks, stencils, cookie cutters, sponges, textured fabrics or construction paper. You can cut the cards yourself from large sheets of paper or buy prepackaged stationery cards, which are available at art and office supply stores.

To avoid using an envelope, and to save on postage costs, you can create holiday postcards or self-mailers. Keep in mind, though, that a postcard doesn't allow much room for a personalized message.

Some people like to have their homemade cards professionally printed. While the end result is quite nice, it

can be an expensive proposition, particularly if you're using a color other than black.

If you want to create personalized holiday cards but lack the time or energy to make your own, Hallmark offers a unique alternative.

Card Studio is a CD-ROM that allows you to create your own cards using a selection of more than 200 pieces of artwork, 900 clip-art symbols and more than 1,000 original messages. The kit comes complete with a selection of high-quality paper and envelopes and is compatible with Windows 3.1 and Windows 95.

Rather than sitting down and writing 75 Christmas or Hanukkah cards in one evening, spread it out over the course of a week or two. This will make the task less daunting and will keep your holiday spirits up.

The post office recommends using black or blue ink on the envelope to ensure speedier delivery. Be sure to always include a ZIP code as well as your return address.

## YULEFACTS

### The cards say it all

More than **2 billion** cards will be exchanged this yuletide season.

**91%** of holiday cards will be mailed.

The average household sends and receives **28 cards.**

Men take more time than women choosing the perfect card.

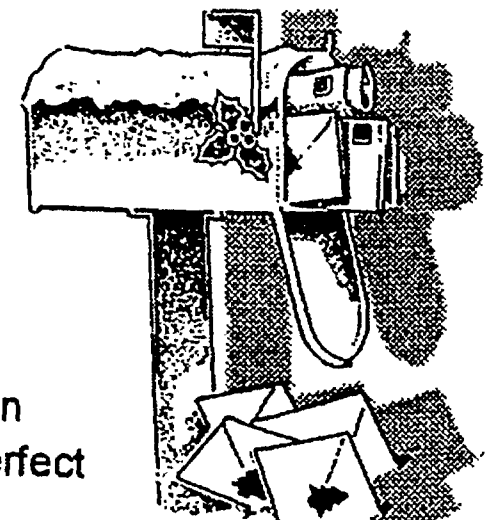

Source: Hallmark Cards Inc

10% OFF ANY ONE NON SALE ITEM WITH THIS AD



**Open House**  
Nov. 29-31

**Holiday Gifts for Him & Her**

**Gift Certificates**  
**Free Gift Wrapping**

It's so hard to find out who

*Naughty & Nice*  
Jewelry Apparel & Gifts

412 W. Main • Brighton  
227-9566

10% OFF ANY ONE NON SALE ITEM WITH THIS AD

**Wood 'N Things**  
Special Gifts for Special People



Don't miss our Christmas Caboose, which is bursting with Santas, Ornaments, Wreaths, Garlands, Snowmen, Christmas Cheer and where the magic of Christmas never ends!

If you joined us last year, you'll be SURPRISED! If you missed us last year, you'll be AMAZED! Share the sights and sounds of this holiday season as you browse through our unique selection of gifts and decorations

Layaway now so you won't be disappointed. A 10% deposit holds your selection until December 10th

- Outdoor Decorations
- Christmas Tapestries
- Holiday Candles
- Ornaments
- Angels
- Speciality Food Items
- Custom Wreaths
- Snowmen
- Pottery
- Santas

Gift Certificates Make Wonderful Presents

We specialize in finding the right gift for that hard to shop for person.

**Wood 'N Things**  
200 Hyne Street  
(1 block off Main in Downtown Brighton)  
**(810) 227-2837**

**HOLIDAY HOURS:**  
Mon.-Fri. 10 am - 8 pm  
Saturday 10 am - 5 pm  
Sunday Noon - 5 pm

**Divers Incorporated**  
Diving & Snorkeling Equipment

**Gigantic Holiday Sale**

**Plymouth Store Only**  
SATURDAY & SUNDAY, DECEMBER 7th & 8th - 10 A.M. - 5 P.M.  
Sale too big for both locations. All staff will be at the Plymouth store only.  
The Ann Arbor store will be closed for this weekend only.



**BCD's** starting at only..... **\$150<sup>00</sup>**  
**Computers** as low as..... **\$200<sup>00</sup>**  
**Regulators** starting at only..... **\$125<sup>00</sup>**

**Masks, Fins**  
**Snorkels**  
**Wetsuits**  
**Drysuits**  
**and much more!**  
**at unbelievably low prices.**

**42295 Ann Arbor Road**  
(PMC Center) PLYMOUTH  
**(313) 451-5430**

**OPEN SUNDAY**  
12/15  
12/22

HOLIDAY HOURS: Mon. thru Fri. 11-7; Sat. 10-5; Sun. 12-5

**All Our Best for a Crafty Season...**



- UNIQUE Gift Items
- Holiday Wreaths
- Christmas Decorations
- Gift Bags & Tissue
- Fine Jewelry & Costume Jewelry
- Greeting Cards
- Gift Certificates

Over 1200 Local Craft and Antique Dealers Display Their Merchandise on a Daily Basis

**Countryside Craft Mall & Antiques**  
WALLED LAKE - (810) 926-8650  
1154 E. Maple Road Bet. Decker & Pontiac Trail

**4 LOCATIONS**

**LIVONIA**  
(313) 513-2577  
35323 Plymouth Rd.

**STERLING HEIGHTS**  
(810) 977-1633  
40700 Van Dyke at 18 Mile Road

**FLINT**  
(810) 230-0885  
4333 Miller Road

**Walled Lake Map**  
Pontiac Trail, Maple Rd., Countryside Crafts, Decker

**Extended Hours:**  
Mon thru Sat 10-8  
SUN 11-5

# Finding and decorating tree is a family activity

Continued from 8

think about the amount, size and weight of the ornaments and lights you plan to use.

**Douglas firs:** have evenly spaced branches and short needles that tend to stay on long after the tree is cut.

**Scotch and white pines:** long-needle varieties with the traditional, attractive cone shape.

**Blue spruce:** an indigo-tinted pine with a nice look, but loses its needles relatively quickly.

## FROM STORE TO STAND

Once the chosen tree has been hauled home, place it immediately in a pail of water and out of direct sun or freezing cold until you're ready to bring it indoors.

Before placing it in a tree stand, 1 or 2 inches should be cut off the bottom, so that the tree can draw water up into the trunk and remain fresh longer.

To keep it from drying out prematurely, take care not to set it up close to heat sources like fireplaces, heaters or heat vents. Check and fill the stand with water frequently. A hardworking

tree needs a lot of moisture to keep its good looks!

Finally, before you begin to decorate, make sure the tree is firmly in the stand and sturdy enough to ride out the entire season.

## SEASONAL SAFETY

Select decorative light strings that are UL approved, as they have already passed the Underwriters Laboratories' safety tests. Never use outdoor light sets for a tree set up inside the home.

Check all light cords and connections for fraying, exposed wires or other types of damage. Look over the bulbs as well, bare spots and peeling paint indicate the lights could be generating too much heat.

Keep the tree well watered to avoid premature drying and inspect tree branches occasionally for dry spots that could ignite more easily. Make sure to keep lights and extension cords away from water-filled tree stands. Unplug light strands before retiring to bed and whenever you leave the house.

Beautiful trees and shiny ornaments are almost irresistible to curious toddlers. Try to place the tree high out of

## YULEFACTS

### When do people buy their Christmas trees?

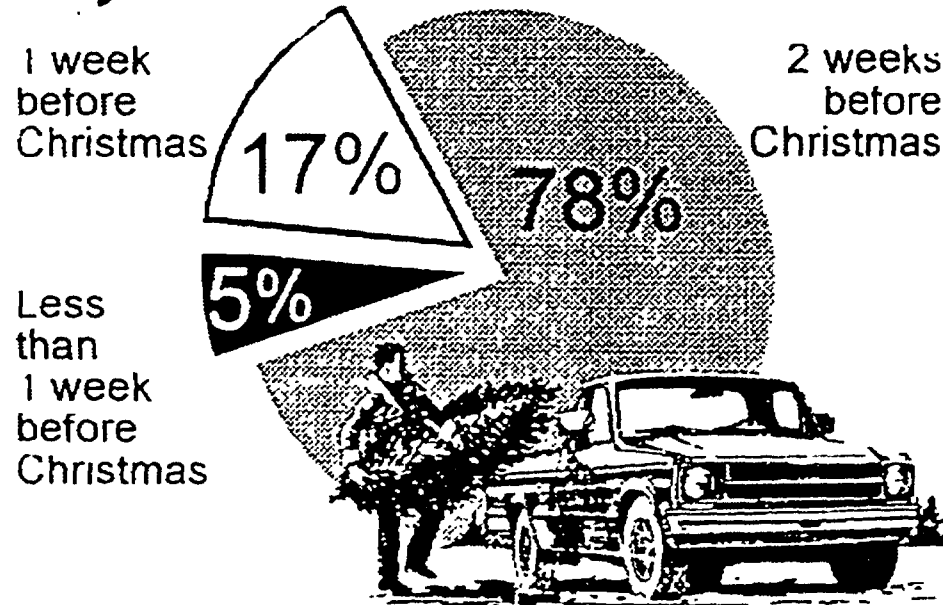

Source: 1-800-FLOWERS

their reach, or in an area of the house they don't frequently play in. Avoid glass ornaments that break easily (at

least down low) and tinsel that is made from lead if you have young children in your home.

# Wreaths are an easy and inexpensive holiday project

Continued from 11

relatively inexpensive. The basic supplies needed include a hot glue gun, glue sticks, wire, toothpicks and floral pins and, of course, whatever decorations you choose to use. You'll also need to determine what type of wreath form to use - straw, wire or plastic foam.

Straw forms are probably the most versatile and durable, and they come in a wide variety of sizes and shapes. Wire forms are best for wiring objects together, such as pine cones or dried fruit. Plastic foam is the least durable but is well suited for attaching light materials, such as wrapped candies, bows or cloth.

Before you begin working on the wreath, gather all the materials and make experimental placements to see how the elements will fit together best. Is the effect interesting? Is there anything you can add that will make it more eye-catching? If you know where the wreath will hang, consider the size of the space and the dominant colors.

Try to keep proportions the same. One element that is way out of scale with the others may ruin the final com-

position.

The most traditional holiday wreaths, of course, are those made of evergreen and trimmed with red ribbon, but there's no reason you shouldn't experiment with other materials, such as nuts, berries, spices, seashells, juniper, fresh flowers, dried fruit or flowers.

When using greenery, cut the boughs in short lengths of about 4 to 6 inches and place stems in the same direction. Make sure each piece of greenery overlaps so that the wreath form doesn't show. Once you've attached the greenery with wired picks or glue, prune it for a uniform shape. Add juniper, baby's breath or red roses for contrast or simply attach a bright colorful bow.

If you want to create a more whimsical look, consider using miniature toys, bells or red-and-white peppermint candies. Other embellishments that make an interesting wreath include waxed

fruit, loose boughs of bayberry and white pine, clusters of hydrangea and miniature apples. If the wreath is hung near a window, you may want to wrap a strand of miniature lights around it.

Wreaths don't have to be hung to be used effectively. Consider using one as a centerpiece or to jazz up a candle arrangement. Or create a garland to drape across the mantelpiece or over a doorway. Another alternative to traditional wreaths is to decorate a straw fan, hearth broom or basket with a cluster of wired greenery, flowers or grasses.

Or you can tie sheaves of corn and wheat with wire and ribbon for a country look.

Here are a couple of wreath ideas to get you started:

**Magnolia wreath.** The beauty of this wreath is that it can be hung long after the holidays are over. To make the wreath, you'll need to gather unblemished magnolia leaves that are uniform in size. Wash the leaves with cold

water and remove stems.

Using floral pins, attach the leaves around the inside of a straw wreath form, going in the same direction.

Follow the same steps for the outside of the wreath and on the final layer spread sets of three leaves in a fan shape and attach with floral pins. Use red berries, miniature pine cones or other accents as desired.

**Eucalyptus wreath.** This fragrant wreath can either be left natural or spray painted in gold or silver for a more elegant look.

To make the wreath, strip about 80 mature eucalyptus leaves from their branches, layer between sheets of wax paper, and press overnight beneath a stack of books. Eucalyptus leaves have a natural curve to their stems so select an equal number of right- and left-leaning leaves.

To attach the leaves to the wreath form, bind them one at a time with a single length of floral wire, coiling it several times around each stem before placing the next leaf on the frame overlapping the previous stem. To finish, add a wide ribbon through the wreath and tie in a big, loose bow.

## ROMAN ROOTS

Christmas celebrations date all the way back to the ancient Roman celebration of Saturnalia, a wintertime festivity during which people decorated their homes with greenery and exchanged tokens with friends and family. (CNS)

You're Invited To  
**DOWNTOWN MILFORD'S  
 CHRISTMAS  
 OPEN HOUSE**  
**THURSDAY, DECEMBER 5TH; 6-9 P.M.**  
 Sponsored by: The Milford Business Association

**CANDLE, CAN & CAROL** 5:45 pm  
**ARRIVAL OF SANTA** 6:00 pm

• Bands • Choral Groups • Refreshments  
 Co-sponsored by: Providence Hospital and the Appe'teaser.

**Pictures with Santa**

During CHRISTMAS OPEN HOUSE 12-5-96  
 By: Kwik Photo 1-5x7 only \$5.00



**JOIN US FOR OUR  
 HOLIDAY  
 OPEN HOUSE**

Thursday, December 5, 1996  
 9:30 am til 9 pm



400 N. Main St.  
 Milford (810)684-6044

• Prints • Collectibles  
 • Originals • Custom Framing

"Little Angels" BY: STEVE HANKS

**25% OFF STOREWIDE**  
 Some exceptions. 12-5-96 only

Visa • MC • Disc • No Fee Lay-a-way



For All Your  
 Holiday Floral  
 Needs...

Think Of Us!



The Only Florist On Main Street!  
 "Serving the Huron Valley Since 1975"

**THE VILLAGE FLORIST**

Mon.-Fri. 9:30 a.m. to 6:00 p.m.; Sat. 9:30 a.m. to 5:30 p.m.

Additional Parking & Entrance in Rear

401 N. MAIN ST., MILFORD (810) 685-9012

**HAPPY HOLIDAYS**  
 From SPARTAN TIRE



"We're Bigger To Serve You Better!"  
 Our professional staff: John, Mark, Mac, Mike, Joe & Mike  
 "STOP IN AND SEE US SOON."

**WHEEL ALIGNMENT • SHOCKS • BRAKES • MUFFLERS • FRONT END REPAIR**

"SERVING THE HURON VALLEY SINCE 1975" **MONROE**

**SPARTAN TIRE**  
 your personal TIRE AND SERVICE CENTER

Our Bigger Home  
 115 E. Liberty Street, Downtown Milford  
 684-5251 & 685-7777

"Your Holiday  
 Hometown Bakery"



- Holiday Breads
- Finnish Pasties
- Party Trays
- Cookies
- Cakes
- Wedding and Party Cakes
- "Killer" Brownies
- Muffins
- Low Fat Bagels & Muffins



MILFORD BAKING COMPANY Mon-Sat. 5:00 am to 6:00 pm  
 408 N. MAIN STREET  
 DOWNTOWN MILFORD 685-2200

**Visit With Santa**  
 on Main Street

- Thursday, Dec. 5th - 6 to 9 pm
- Thursday, Dec. 12th - 6 to 8 pm
- Thursday, Dec. 19th - 6 to 8 pm

at the Village Center Mall



You're Invited To  
**DOWNTOWN MILFORD'S  
 CHRISTMAS  
 OPEN HOUSE**

**THURSDAY, DECEMBER 5TH; 6-9 P.M.**  
 Sponsored by: The Milford Business Association



**CANDLE, CAN & CAROL** 5:45 pm  
**ARRIVAL OF SANTA** 6:00 pm

• Bands • Choral Groups • Refreshments  
 Co-sponsored by: Providence Hospital and the Appe'teaser.

**Pictures with Santa**

During **CHRISTMAS OPEN HOUSE** 12-5-96  
 By: Kwik Photo 1-5x7 only \$5.00

**READ BETWEEN THE LINES  
 BOOKSELLERS**

341 N. Main Street, Downtown Milford  
 (810) 684-7285



OVER 20,000 BOOKS  
 ALL SUBJECTS . NEW RELEASES  
 SPECIAL ORDERS WELCOME

Gift Certificates  
 Available

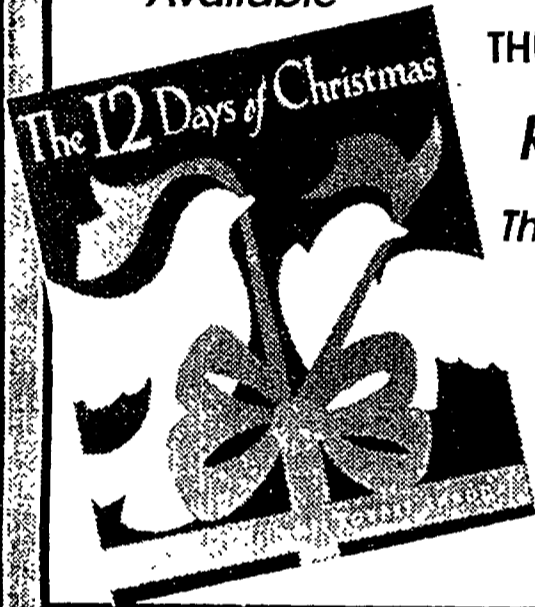

PLEASE JOIN US ON  
**THURSDAY, DECEMBER 19th**  
 at 6 p.m. to meet  
**ROBERT SABUDA**  
 author of  
*The 12 Days of Christmas*

**HOLIDAY HOURS**  
 11-1-96 to 12-24-96  
 MON.-THURS. 10 to 7  
 FRIDAY 10 to 8  
 SATURDAY 10 to 6  
 SUNDAY 11 to 4



MS. DUANE KARR  
 & ASSOCIATES



**Think Gifts!  
 FULL BODY  
 MASSAGE!**

**GIFT  
 CERTIFICATES**

MASSAGE THERAPY

Buy 3  
 1 Hour  
 NOW  
 \$45 ea.  
 Reg. \$50ea.

**The Best Idea Yet!**  
**\$5 Off 3 Massages**  
**Save \$15**

Aromatherapy  
 Herbal Oil  
 Included Free

With coupon • Expires 12-25-96

5 Massage Therapists • 2 Massage Therapy Rooms  
 Ms. Duane Karr & Associates  
 Massage Therapy  
 (810)685-3628 (phone & fax)  
 Our Downtown MILFORD OFFICE

441 N. Main Street (rear)  
 Lower Level/Rear Entrance  
 Of Cobb Insurance Agency

Appt. Avail.  
 M-F 10 a.m. - 9 p.m.  
 S & S 10 a.m. - 2 p.m.

Pull in, enter from rear parking lot off Commerce, west of Main Street, behind Legends of Time

**Duane Karr's Crystal Rainbow Co. Store Offers:**  
**Gifts From \$1<sup>00</sup> & Up**

Crystals: Quartz, Amethyst, Rose Quartz, Gemstone Hearts  
 Aromatherapy: Rose Floral Water, Jasmine Perfume, Lavender Body Oil,  
 Angel Scent Kit, Scent of the Goddess

Classes: Massage Therapy.

Aromatherapy, Yoga, Tai Chi, Positive Thought, Self-Help Massage Tools - FREE, Skin Care

★ ★ ★ ★ ★ ★ ★ ★ ★ ★ ★ ★ ★ ★ ★ ★

Massage Therapy Gift Certificates plus Duane's wonderful Herbal Massage  
 & Body Oils are also available at Art & Sol and The Health Mart in Milford



Join us for this holiday  
 celebration  
**MILFORD'S  
 CHRISTMAS  
 OPEN HOUSE**  
 Thursday, December 5th  
 6 to 9 p.m.

- Limited Edition Prints • Ready Made Frames
- Original Art • Dry Mounting
- Poster Art • Pottery • Gifts

"Creative Designs in Custom Framing"

**main street ART  
 GALLERY**

432 N. Main Street, Milford (810)684-1004

Merle Norman  
 creates **Holiday Magic. Free!**

"Full Service Salon"  
**MERLE NORMAN  
 COSMETICS**

**A CUT ABOVE**

The Place for the Beautiful Face.  
 338 N. Main St., Milford  
 (810) 685-0810  
 Mon thru Thurs. 10 to 8  
 Fri 10 to 6, Sat 9 to 3

\*Free gift with purchase of two or more  
 Merle Norman cosmetic products.

Our Holiday Magic gift includes trial sizes of:

- LUXIVA PREVENTAGE Firming Eye Cream
- LUXIVA AHA Emulsion
- Lip Pencil Plus in Coral Rust



**Coe's  
 CLEANERS  
 NEW LOCATION!**

155 E. Commerce 685-3121 & 685-0770  
 Hours: Mon.-Fri. 7-7; Sat., 9-5  
 Quality Dry Cleaning & Shirt Laundry

- Alterations
- Leather Cleaning
- Wedding Dress Preservation
- Shoe Repair

**20% Off Incoming  
 Dry Cleaning Only**

With Coupon  
 Expires 12-14-96

**Coe's  
 CLEANERS**



You're Invited To  
**DOWNTOWN MILFORD'S  
 CHRISTMAS  
 OPEN HOUSE**

**THURSDAY, DECEMBER 5th; 6-9 P.M.**  
 Sponsored by: The Milford Business Association



**CANDLE, CAN & CAROL** 5:45 pm  
**ARRIVAL OF SANTA** 6:00 pm

• Bands • Choral Groups • Refreshments  
 Co-sponsored by: Providence Hospital and the Appe'feaser.

**Pictures with Santa**  
 During CHRISTMAS OPEN HOUSE 12-5-96  
 By: Kwik Photo 1-5x7 only \$5.00

**MAIN STREET  
 WINE SHOPPE**

**HOLIDAY GIFT BASKETS**  
 for Personal and Professional Gift-Giving

**OUTSTANDING SELECTION** **CORPORATE GIFT PROGRAM**

A terrific assortment of cheeses, crackers, chocolates, nuts, cookies, coffees, gourmet condiments, beer, ales, wine and more! Many different styles and sizes available.  
**COMPLETE PACKAGING, DELIVERY & SHIPPING SERVICE AVAILABLE.**

Let us represent you this holiday season with tastefully designed gift baskets. Perfect for professional gift-giving needs.  
**BEAUTIFUL GOURMET GIFT BASKETS STARTING AT \$30.00**

Complete Packaging, Delivery and Shipping Service Available. We are now accepting orders.



**426 N. Main St.  
 MILFORD**  
 Mon.-Sat. 9 to 9; Sun. 12 to 5  
 (810)685-7195  
 Fax (810) 684-2686

**Gourmet Gift Ideas and Fine Cigars**

**LEGENDS OF TIME** MONDAY - FRIDAY 10-6  
 SATURDAY 10-5  
 SUNDAY 11-4

453 N. MAIN STREET • MILFORD, MI 48381  
 (810)685-0911



Authentic and unique Southwest Native American gifts and decor, dream-catchers, kachinas, tiles, pottery, peacepipes, mandallas, cards, jewelry, posters, drums, fetishes, wind chimes and more.

**THE KOKOPELLI**

The Kokopelli is a humpbacked flute player whose Indian heritage dates back as early as 200 A.D. This legendary, well traveled and footloose figure was a god to some, a nuisance to others and a bearer of good luck and health to many. Well known for his gift of fertility, childless wives begged for his company, while unmarried women fled from him with fear.



Join Us During Christmas  
 Open House  
 Thursday, December 5th  
 6 p.m. - 9 p.m.

Enjoy  
 Hot drinks and samples of  
 our stromboli. Also pick up  
 our new menu

Great American Pizza  
 340 N. Main Street, Milford (810) 685-0909

**THE HEALTH MART**

- DHEA
- All Natural Vitamins
- Herbs
- Melatonin - Sleep Aid
- Dairy Free Products
- Homeopathic Medicine
- Mealless Frozen Food Alternatives
- Healthy Snacks
- Gift Certificates



**10% OFF ALL VITAMINS**  
 with this ad. Exp. 12-15-96

400 N. Main St., Milford, Downtown  
 Inside Village Center Mall  
 810-684-MART (6278)

**牡丹樓 PEONY HOUSE**

CHINESE RESTAURANT  
 "Compare Our Prices and quality"  
**FREE PARKING**

**HAPPY HOLIDAYS**  
 Stop in and visit during  
**OPEN HOUSE**

427 N. Main St., Milford  
 684-5444

You're Invited To  
 MICHIGAN'S OLDEST MEN'S CLOTHING STORE  
 Celebrating Our 160th Holiday Season

**10% to 30% OFF**  
 STOREWIDE 6 to 9 12-5-96

**Arms Brothers**  
 Store for Men Since 1836

361 N. MILFORD ST., MILFORD  
 685-8449



**Shop  
 Milford  
 Save Time!**

**Milford Music**  
 "Lesson Today For the Music of Tomorrow"  
 Give the Gift that  
 Lives Forever...  
**MUSIC**

- Gift Certificates for Lessons
- All Instruments! All Styles!
- Sheet Music and Books
- Acoustic and Electric Guitar Packages
- Great Stocking Stuffers.

**Milford Music**  
 347 N. Main Street (Upstairs) 685-9200  
 Downtown Milford  
 Open Monday thru Thursday 10 a.m. - 5 p.m. & Sat. 10 a.m. - 5 p.m.

"BEANNÄCHTAI NA NALLAG"  
 (Bann Knocktee Nu Nulag)  
**BLESSINGS OF CHRISTMAS from**  
**the celtic shamrock**  
 Irish & scottish heritage shop

Phone Orders Welcome  
 Out of State Shipping Available  
 Visa/MC/Discover/American Express  
 Hours: Mon-Fri. 10a.m. - 6 p.m.; Sat. 10 a.m. to 5 p.m.  
 Sun. 11 a.m. to 4 p.m.

# C & C Sports Puts You on the Right Track for Holiday Gift Giving Ideas...

**GOT A LITTLE ENGINEER THAT NEEDS TO BLOW OFF A LITTLE STEAM?**

**zero down**  
**zero interest**  
**zero payments**

when you buy a new '97 or prior RT180, RT100, PW80, or PW50 October 1 through December 31, 1996.



**C&C Sports**  
*Life In The Fast Lane!*

**DON'T FORGET THE GEAR:**  
Our Accessories Department has Lots of Great Gift Ideas

**8090 W. Grand River Brighton • 227-7068**



\* With approved credit using the Yamaha credit card. 16.8% APR on balances up to \$6,000; 12.9% APR on the portion of the balance over \$6,000. \$50 minimum finance charge. Unit must be purchased new from dealer inventory.

**WE'RE PLEASED TO PRESENT YOUR BOARDING PASS**

**PLEASE STORE YOUR BAGGAGE IN THE REAR COMPARTMENT**



**Predatory Instinct**  
Bring out the predator in you with the Polaris Xplorer 400L and Polaris 300. With a two-stroke air-cooled engine, the Xplorers move hunting to the next level.

- Polaris automatic variable transmission
- Push-button engage 4-wheel drive gives instant power when you need it.



**Suit Your Needs**  
Customize your ATV to suit you needs with Polaris parts and accessories. Stop by today and choose from a wide variety of items such as winches, blades and mowers to customize your ATV and get the job done quickly and easily.

**POLARIS** Believe it.

**8090 W. Grand River Brighton 227-7068**

**C&C Sports**  
*Life In The Fast Lane!*

Polaris ATVs may not be ridden by anyone under 18, and all riders should take a safety course. For safety and training information, see your dealer or call Polaris at 1-800-342-3764. ATVs can be hazardous to operate. For your safety, always wear a helmet, eye protection, protective clothing and never carry passengers.

©1995 Polaris Industries Inc.

**GIVE THE GIFT THAT KEEPS ON SHREDDING.**



Wondering what to give? Try a sure-please, 1997 Sea-Doo watercraft. Right now, we've got special deals on the boats that make every day a holiday.



**GOING somewhere "Warm" for the Holidays? Check out our line of SPEEDO SWIMWEAR!**

**MAKE SURE THEY STAY IN "LOCOMOTION" THIS SEASON - GET THEIR TRACK STUDED AND KEEP YOUR CONDUCTOR FROM ENDING UP ON HIS CABOOSE!**

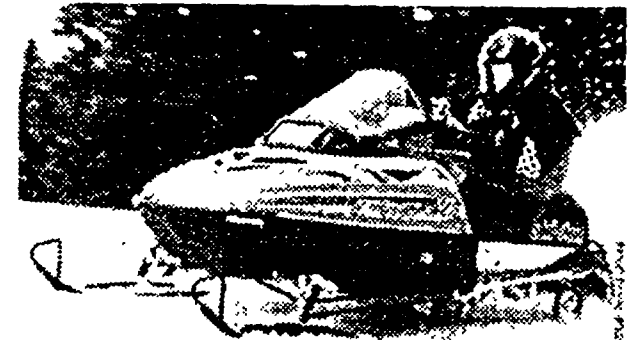

**Snow wonder it's a Ski-Doo \$3399\*\***

The wonder of the Formula S model isn't that it has a 368cc fan-cooled Rotax® engine or that it has a comfortable long-travel SC-10 Sport rear suspension, 40" ski-stance and tough aluminum frame. The wonder of it is the price. So what are you waiting for?



**Santa says... Gloves, Boots, Bibs, Coats and Helmets Sure Beat Coal When it Comes to Gifts!**

**C&C Sports**  
*Life In The Fast Lane!*

**8090 W. Grand River Brighton (810) 227-7068**

**Chug on Down to C & C Sports and celebrate Christmas "in the fast lane!"**

Hours: Mon, Th, Fri 10-8; Tues-Wed 10-6; Saturday 9 to 4



# Surprise loved ones with a good book

By Lee Littlewood

Copley News Service

Books are perfect, sure-to-please holiday gifts. With thousands of titles in bookstores, it's certain something can be found for even the pickiest of recipients. Novels, nonfiction, how-to, religion, poetry, sports, cooking, child care, humor, travel, health, business, self-help books and more are available to appease the tastes of everyone on your list.

A foolproof way to cop an excellent gift is to match tastes and interests with a book. If Uncle Don is an avid fisherman, a fishing book (and there are several) would undoubtedly win his heart. And for sister-in-law Sue who is about to embark on a cruise to Alaska? An Alaskan travel guide or photography book should warm her up for her big journey. And most people appreciate gorgeous coffee-table books to enliven their living rooms.

What will the rest of readers, browsers and aficionados of fine books clamor for this holiday season?

Tom Clancy's "Executive Orders" (G.P. Putnam & Sons) and John Grisham's "The Runaway Jury" (Doubleday) should satisfy intrigue fans. "Third Twin" from Ken Follett (Random House) and, if we can stand one more O.J. chronicle, "Journey to Justice" by Johnnie Cochran (Random House), are both certain to be big sellers, according to a Borders spokeswoman.

And Michael Crichton's "Airframe" (Random House) is due to appear on bookstore shelves in December for last-minute shoppers.

Stephen King followers can get scared twice with "Desperation" (Viking), using his own name as author, and "Regulators," using his pseudonym, Richard Bachman (Dutton). Scoring a sure marketing coup, the two books feature jackets that,

when unfolded, form one picture side by side. Anne Rice latest offering is "Servant of the Bones" from Alfred A. Knopf.

On the opposite end of the reading spectrum, those craving serenity will love Sarah Breathnach's "Simple Abundance: A Day Book of Comfort and Joy" (Warner). With 366 evocative essays written for women who wish to live by their own lights, the stories promise to open hearts.

Another for-women-only tome is geared to those who want to get mentally fit in 1997 and is the latest in the "Chicken Soup For the Soul" series. Intending to provide revelations, heart-warming tales and observations to help make people happy, "Chicken Soup For the Woman's Soul" (Health Communications Inc.) is from the same authors (Jack Canfield and Mark Hanson), plus Marcy Shirnoff, Jennifer Reed and famous women celebrities - no doubt to provide some vital female

input.

Both sexes can partake in emotional health with Daniel Goldman's "Emotional Intelligence," subtitled "Why It Can Matter More Than IQ" (Bantam). This book may be an appropriate gift for that type-A personality who may need to learn to think before acting. "Dogbert's Top Secret Management Handbook" by Scott Adams (Harper Business) is bound to be a business must.

You have be careful, though, when giving a gift book bearing words such as "diet," "exercise" or "low-fat." Could the person receiving the gift think you're trying to give him or her a hint? If your friend or family member has made it known that he or she wants to get in shape, there are plenty of self-help books on the shelves.

Two of the most famous women in entertainment are offering their ideas

Continued on 22

**Brainer's Greenhouse**  
Will help you celebrate the Holidays!

- OVER 20,000 POINSETTIAS IN ALL COLORS AND SIZES
- MANY VARIETIES OF FRESH CHRISTMAS TREES
- FRESH HOLIDAY HOMEMADE WREATH AND ROPING
- CEMETERY BLANKETS

**SPECIALIZING IN FRASER FIRS**

- CUSTOM FLOCKED TREES (White, Green, Blue, Pink)
- BEAUTIFUL HOLIDAY ARRANGEMENTS

Ask about our corporate discount!

**51701 Grand River • Wixom**

(1½ miles west of Wixom Road)

(810) 349-9070

M-F 8-8  
SAT 8-6  
SUN 9-5

**The "Add-a-Cube"™  
Safety Pin.™**

Letter Cubes	\$19.95
Gem Cubes	\$32.95
Lg Safety Pins	\$59.95
Sm Safety Pins	\$29.95

(Not Shown)

**Baby Someone You Love, in 14Kt Gold**  
by Aurafin.®

**Diamond Castle**

JEWELERS SINCE 1902

39955 Grand River Avenue  
Novi (¼ Mile West of Haggarty)  
(810) 442-2440



Why stay home when you can escape the holiday rush with a horse-drawn sleigh ride in a snowy retreat.

## For an exciting celebration, plan a trip

By Alison Ashton  
Copley News Service

Some people love celebrating the holidays at home - all that decorating, baking and entertaining. When it comes to seasonal celebrations, their hearts are with home and hearth.

But others, especially those pressed for time, would like nothing more than to get away from it all. With a small investment of time planning the getaway, it's a relatively carefree way to spend the holidays. Think of it: no parties to plan, no decorations to worry about, no entertaining all your kith and kin.

### WHERE TO GO

Convinced? Now you must decide where to go and what type of getaway you're looking for.

If you prefer to be home for Christmas, you can still enjoy a getaway with one of the many pre-holiday shopping packages offered at hotels in major cities. These take some of the stress out

of the gift-shopping chore, and they let you enjoy the novelty of the holidays in a different city.

Start by choosing a city, then calling hotels to find out what they offer in the way of holiday packages. Packages usually include a reduced room rate, plus a stockingful of enticements - maybe tickets to a local production of "A Christmas Carol," holiday tea service in the afternoon (an ideal way to unwind after a long day shopping) or special discounts at local stores. Some hotels even wrap your packages. What's more, hotels everywhere are festively decorated for the holidays.

For those who want to close up the house and spend the holiday out of town, the options are limitless. For traditional celebrations, head to Europe, where you can discover how other cultures spend the holidays. You can travel independently, but more tour operators are putting together group packages; check with your travel agent.

Too far? Consider heading north of the border to Quebec, where Christmas

has a New World Gallic flair. Or go south to Mexico for a colorful Latino holiday.

Skiers love to head for the hills this time of year. But other revelers want the warm sun, clear water and clean beaches of the Caribbean or Hawaii. If either holiday sounds ideal, make reservations well in advance as resorts fill up quickly.

Also consider how areas closer to home celebrate the holidays. If there's a place you really enjoy, check with the local chamber of commerce to find out what seasonal activities they have planned. For example, Charleston, S.C., has a month of activities planned, with everything from tree-lighting ceremonies to wreath-making workshops to progressive dinners in the city's historic center. Similarly, Humboldt County in Northern California has a full roster of events, including lunch with Santa and a lighted tractor parade; New Year's Eve is celebrated with a square dance.

Or plan a holiday in a truly exotic

destination, such as Africa, Antarctica or even the jungles of Belize. It would certainly be a memorable gift to yourself.

### GOING BY CAR

Getting away may be as simple as hopping in the car for a drive out of town. It's a convenient mode of travel, especially for families with young children. In fact, 55 million people are expected to travel by car this holiday season. But time spent cooped up in the car can add to holiday stress.

"Travel during the holidays can be hectic, particularly car trips, but it also can be an opportunity for families to spend quality time together," says Donald B. Weaver, Ph.D., a Dallas psychologist.

Weaver, a father of two, says advance planning is the key to a pleasant trip for all. "When children see their parents enjoying themselves, the

Continued on 22

\* A Christmas Wish \* \* A Christmas Wish \* \* A Christmas Wish \*

## Give the Gift of Creativity

Gifts for the Artistically Undiscovered as well as Experienced Artists

 <b>Floor Easels</b> <b>\$20-\$60 OFF</b>	 Winsor-Newton <b>Paint Sets</b> <b>20-30% OFF</b>	
 <b>Creativity for Kids Sets</b>	 <b>Air Brushes Mat Cutters</b>	 <b>Cartoon Kits</b>
 <b>Gift Certificates</b>		<small>Extended Holiday Hours Beginning Dec. 22                  10:00am-7:00pm, Sun. 10:00am-12:00pm</small>



**the creative side**

**Art Supplies Custom Framing**

9864 E. Grand River, Brighton  
 (In VG's Food Center, behind NBD)  
 (810) 220-3244

\* A Christmas Wish \* \* A Christmas Wish \* \* A Christmas Wish \*

\* A Christmas Wish \* \* A Christmas Wish \* \* A Christmas Wish \*

# Play with the BEST

## Rugged John Deere Toys Are Built for Tough Fun

Sturdy, die-cast scale models of the real thing, these toys can hold up in the rough and tumble world of today's kids. Stop in soon and see our selection.

<b>Small scale 1/64 to 1/16</b>  from <b>\$2.95</b> & up	<b>Pedal Riding Models</b>  <b>\$159.95</b> to <b>\$169.95</b>
---	---

**Toys for the Collector! Toys for the Outdoors!**

NOTHING RUNS LIKE A DEERE. 

 New, Used, Parts, Service Pickup & Delivery (800) 870-9791	<h1 style="font-size: 2em;">Thesier</h1> <h2 style="font-size: 1.5em;">Equipment Co.</h2> 28342 Pontiac Trail • South Lyon 48178	 Mon.-Fri. 8am - 6pm Thurs. 8am-7pm Sat. 9am-3pm (800) 870-9791
--	--	--

\* A Christmas Wish \* \* A Christmas Wish \* \* A Christmas Wish \*



**ENJOY**

# AN OLD-FASHIONED CHRISTMAS

**SHOP DOWNTOWN MILFORD**

THE LOCAL MERCHANTS WILL HAVE EXTENDED HOLIDAY HOURS

**MARK YOUR CALENDAR FOR...**

- **MILFORD'S CHRISTMAS PARADE**  
Saturday, November 30th - 10 am on Main Street
- **CANDLE CANS & CAROL**  
Thursday, December 5th - Downtown Milford 5:30 to 6:00 pm - Bring a canned food item to give! Entertainment and Refreshments.
- **CHRISTMAS OPEN HOUSE**  
Thursday, December 5th - Downtown Milford 6 pm to 9 pm. Enjoy High School Bands & Choral Groups. Santa arrives at 6:00 pm
- **VISIT WITH SANTA ON THURSDAY**  
December 5; 6 to 9 pm at the Village Center Mall  
Other Santa visiting times to be posted!

# Books make wonderful, thoughtful gifts

Continued from 19

Shel Silverstein" and "A Pizza the Size of the Sun" by Jack Prelutsky (Greenwillow Books) are two more must-haves, both full of witty, fun poetry for the young and young at heart.

## DAY BY DAY

By Lee Littlewood

Copley News Service

Calendars, whether wall, appointment, boxed or pocket, are vital in these times of rushed lives and busy days. More than just organizers and appointment keepers, calendars for 1997 are artsy, bold, beautiful, funny and decorative - and smart holiday gifts.

"How to Talk About Men and Still Be Politically Correct" from Daydream Inc. is one of the funniest. The calendar pages are adorned with beefcake photos of males, and the text fills in bits and pieces about the models, such as He does not have a hot body, He has

a vehicular addiction and He does not eat like a pig.

While we're on the subject of calendars for women, "The Perfect Man" (also from Daydream Inc.) features photos of objects, a teddy bear, Pez dispenser, Santa Claus and knight statues, and explains why these really are perfect men.

Men aren't left out in the cold, however. Longmeadow's "Women of Summer" is a desk-size calendar with plenty of warm-weather photos of cavorting women cavorting on the beach.

Sports Illustrated's swimsuit calen-

### SHOP EARLY

Holiday gift shopping can be full of hassles, but pre-planning will make it more pleasant. Jennifer Newstrom of Marshall's recommends shopping early for the best selection and smallest crowds.

To stay focused, make a list of gift ideas. Only 18 percent of shoppers actually do this, but taking a moment to think about what Uncle Sam and Aunt Minnie would really like will save hours of aimless browsing.

Budget shopping time into your schedule. Time is money, so don't waste it. Plan several one- or two-hour shopping excursions rather than trying to accomplish everything in one day.

Shop at stores with flexible return policies. Three out of four people say they are likely to return some holiday gifts, and clothing items account for 61 percent of returned gifts. (CNS)

dar should also appease males who love to gaze upon women's swimsuits - or, rather, the women in them.

"Baseball" from Knopf, is an old-fashioned calendar full of the good ol' days about the boys of summer. While we're on the topic of summertime (and who doesn't like to dream during the cold holiday months), "Sailing" from Longmeadow should keep boating fans dreaming of breezes while they plan dentists' appointments and meetings.

If fancies turn to sailing through the sky, "The World Record Paper Air-

plane Book" (Workman) features designs of 12 innovative paper airplanes ready to fold and fly at each month's end.

Nature fans have their pick of the liters. Sierra Club's "Baby Animals" is aimed at kids with 100 stickers included to help keep track of birthdays, hiking trips and recycling days. Sierra Club also releases "Wilderness," "Birds," "Wildlife" and "Butterflies," for all ages, and the Audubon Society always offers plenty of nature-oriented calendars.

Nickelodeon's "The Secret World of Alex Mack" and Scholastic's "Goosebumps" should please children, as should the "The Cat in the Hat Collectible Calendar" for fans of Dr. Seuss. Random House is offering this calendar through WaldenBooks and other bookstores free with the purchase of two Dr. Seuss hardcover books.

"Dolls" from Workman, captures collectible, vintage dolls at their finest while Lang Graphics' many calendars, including their "Schoolhouse Monthly Planner" and "Folk Art Engagement Pocket Calendar," are gorgeous.

# Planning a relaxing holiday celebration away from home

Continued from 20

positive message is passed on, and the children will be happy, too."

Take time to plan ahead, and involve children in the preparations. Show them a map so they can see where they're going and let them help select the route. Look for interesting stops to make along the way - even if it involves a brief detour. You'll discover that getting there can be as fun as being there.

On a more practical note, be careful when packing the car. It's tempting to overload it with lots of extra packages, but makes for an uncomfortable ride for the passengers. Also bring along light snacks and travel-size games and coloring books to keep restless children occupied.

Finally, consider security issues when traveling by car. Don't leave items in view when the car is unoccupied. Gaily wrapped packages are a tempting invitation to thieves.

## GOING BY AIR

Yes, it's great fun to celebrate the holidays out of town. But getting there can be enough to turn anyone into Scrooge. Here are some ideas for making it easier in transit.

Save cash. To save money on expensive airline tickets (this is prime time for the airlines and few discounts are available), consider flying with a small-

er airline. Other money-saving possibilities include flying to a less convenient (and possibly less-crowded) airport and making your journey in two legs (usually cheaper than nonstop routes).

Take your time. When airports are crowded and tempers are frayed for both passengers and personnel, it's wise to leave plenty of time to get to the airport, check in for your flight, board the plane, etc.

Leave bulky or delicate items at home. During the holidays, people always board planes with bags and boxes of gifts, which must be stowed under the seat or in an overhead compartment. There is inevitably more junk than the plane can carry. Remember, gifts can be shipped ahead, which will save you the hassle of toting them.

Whatever you do, don't be like a woman observed on an overcrowded flight from San Diego to Albuquerque, N.M., last Christmas.

"Don't squash my tea cakes," she commanded the harried flight attendant who was trying to squeeze her bag of baked goods into a crowded overhead compartment. "I spent all day yesterday baking."

He (and her fellow passengers) looked at her in disbelief.

"Don't worry, ma'am. I'll take good care of your cake," he said, pleasantly, giving the sack of goodies an extra shove.

## TO GRANDMOTHER'S HOUSE WE GO

By Alison Ashton

Copley News Service

For thousands of seasonal revelers, travel during the holidays means packing up the family and heading to Grandma's house. Visiting the relatives can be a lot of fun - or it can fuel a long family feud. Rude and lazy guests who overstay their welcome are enough to make even the most patient host scream, "Bah, humbug!"

When asked what guests should do when visiting family members for the holidays, manners maven and syndicated columnist Letitia Baldrige quickly reeled off a list of practical tips. Among them:

Never stay more than three days.

Offer to bring something to help celebrate the holidays. It could be an item to decorate the house, a cheery recording of Christmas carols or a contribution to the holiday meal, such as the turkey or dessert. This is in addition to a nice token strictly for the host (a box of gourmet chocolates is good, or perhaps a bottle of wine).

Arrange ahead of time to take the entire host family - "even the kids" - out to a nice restaurant for dinner one night. Since this is a busy time of year for restaurants, remember to

make reservations well in advance.

"Be very helpful around the house." Take out the trash when you notice it's full, get up early to prepare breakfast, help clean up after meals. If several families with children are gathering, offer to take restless kids to the movies one afternoon or for a drive one evening to enjoy the neighborhood holiday lights. Your hosts will welcome the reprieve and the kids will enjoy the outing.

"Be enthusiastic about everything, regardless of how you feel about it." You may not enjoy all your host family's holiday rituals, but you are the guest, so follow the game plan with a smile.

Prepare children to be good guests by briefing them beforehand. Tell them to treat their host's home even better than their own. Of course, they should know to say "please" and "thank you" when it's appropriate.

Baldrige also recommends coaching children to make a brief toast at the holiday meal. Even small children can stand up, thank the hosts and wish them well in the new year.

"When little children do that, everyone just melts," says Baldrige.

And those charming little ones - and their considerate parents - will probably be invited back next year

# Shopping, money, family top list of holiday hassles

By Priscilla Lister  
Copley News Service

Janet David, a New York City clinical psychologist, estimates that 10 percent to 15 percent of her clients seek counseling during the holiday season because of stress.

Time and budget pressures are rampant during the holidays. To help put the festivity back into the season, organize.

"Getting organized removes the mental and physical burdens that distract you from accomplishing and enjoying the things that are important in your life," says Stephanie Denton, a professional organizer and adviser to Organized Chaos Inc.

Organized Chaos Inc. is a national club dedicated to simplifying home

management by helping people organize their lives. Members, who pay \$2.50 to join, receive The Chaotic Times newsletter filled with tips and advice on getting organized and simplifying home management. Contact Organized Chaos Inc., P.O. Box 4120, Grand Rapids, MN 55730-4120.

## TIME MANAGEMENT

There may be no better time to simplify than during the holidays. Consider some helpful hints on holiday time management put together by Denton and her colleagues at Organized Chaos:

Ask recipients what gift they'd like. Create a master "To Buy" list and never go shopping without it. Map it

Continued on 24

## YULEFACTS

### Holiday headaches

The holidays are the season of good will, but with a price. Here are America's top five holiday hassles.

Overindulgence  
in food and drink

Christmas  
shopping

Spending too  
much money

Traveling to see  
friends and family

Putting up and  
taking down decorations

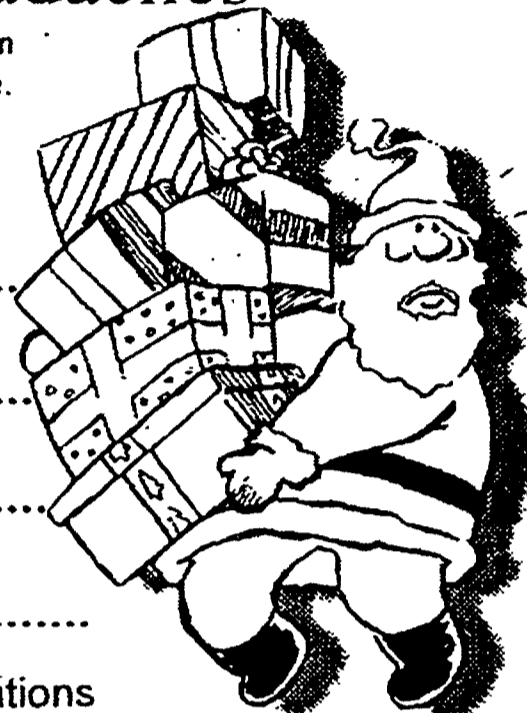

Source: Alka-Seltzer

# From one extreme to the other

*(and everything in between)*

Striking black and glass halogen pendant designed by architect William Fitzpatrick.  
Dimensions: 28" long, 5" high and 5" wide.  
Reg: \$175.00  
Sale: \$124.95

Six light verde wrought iron chandelier with shades for a beautiful finishing accent.  
Dimensions: 23" high and 32" wide.  
Reg: \$824.40  
Sale: \$579.95

Six light cast French brass chandelier with French Vianne Nuage shades.  
Dimensions: 32" wide and 32" high.  
Reg: \$1860.00  
Sale: \$1299.95

These and many other fixtures are Holiday Priced through December 21.

## Michigan Chandelier

Light Years Ahead in Customer Service.

Bloomfield  
6580 Telegraph at Maple Rd. ☎ 810-626-2548

Novi  
45319 Grand River, One Mi. W. of Novi Rd. ☎ 810-344-0260

Rochester  
200 E. Second St., E. of Main St. ☎ 810-651-4302

# Minimizing hassles during the holiday season

Continued from 23

out by store location before you leave home to avoid wasting time.

Use your home computer to centralize all holiday planning activities, including dates of holiday parties, travel itineraries, menus and shopping lists, cards sent out and more. Denton suggests home management software such as Microsoft Bob.

Create a schedule for all the household jobs that need to be done to prepare for the holidays; assign each family member specific tasks.

Accept that you may not be able to do everything yourself. Hire an ambitious high school student during winter break to help cater a party, wrap presents or perform other tasks you can't find time to do.

Make a list of gifts and the gift-giver's name as you open each present to make thank-you notes easy.

## BUDGET MANAGEMENT

Beware the holiday spending spree that wrecks financial havoc on your new year.

The International Association for Financial Planning in Atlanta suggests you "leave your 'plastic' at home and check your emotions at the door. These are two sure-fire ways to make your holiday shopping more enjoyable, affordable and successful."

"Paying today's bills with tomorrow's money will catch up with people," says Les Kirschbaum, president of Mid-Continent Agencies Inc., a national accounts receivable management firm in Rolling Meadows, Ill.

The best approach to control holiday spending, says Kirschbaum, is to budget your money carefully.

"Wait for chosen items to go on sale. Don't shop when you're tired because you'll tend to rush and make expensive mistakes," he adds.

He offers these tips to avoid post-holiday financial blues:

**Establish a budget.** Set an appropriate spending level for each person on your gift list and stick to it.

**Pre-select gifts.** Make a gift list for each person to prevent impulse buying and overspending.

**Develop a repayment plan for purchases.**

"The key is to plan ahead and start saving now for those bills that are deferred, so you don't experience an even bigger cash crunch in January and February," says Kirschbaum.



Mall crowds are one of the reasons why holiday shopping is a hassle.

## CREDIT CRISIS

Holiday time is spending time for many shoppers, who buy more gifts than they can comfortably afford.

"This is the time of year when people can easily spend more than they should. Some get carried away by the holiday spirit, while others feel obligated to make the grand gesture even if that is not in their best interest financially," says Becky Cutler, spokeswoman for Citibank MasterCard.

But it is possible to control holiday spending with a little discipline. Some suggestions from Cutler:

Don't feel compelled to buy a gift you can't afford.

Avoid last-minute shopping, when you might be forced to spend more

Avoid using national credit cards and department store charge cards with high interest rates.

Beware of deferred payment plans.

than you should due to limited choice and time. Also avoid shopping when you're tired or hungry; it's too tempting to buy items on impulse.

Postpone large purchases until after Christmas in order to take advantage of post-holiday sales.

## COMPUTER CHRISTMAS

Computer hardware is a popular gift. Before buying, consider the recipient's needs, do homework by reading computer magazines and buy from a retailer who can offer high-quality post-purchase technical support.

"For families with children, it's best to find out what kind of computer your child uses at school and how they use it," advises James R. Kruse, senior computing consultant at Emory University in Atlanta. (CNS)

"Some consumers can forget they even made the purchases and get caught with a sizable bill they can't pay off in March," he says.

## SHOPPING PITFALLS

Keep in mind the following shopping pitfalls outlined by Consumers Union:

**The sales pitch.** Beware of high-pressure sales pitches to buy an extended warranty - often the most profitable item in the store for retailers.

"The fact is, most failures in electronic products generally occur early in the life of the product, when the manufacturer's warranty is still in effect, or at the end, by which time an extended warranty usually will have expired," says Consumers Union.

**Store credit cards.** Consumers are often offered the chance to save 10 percent or more on their first purchase by getting a store credit card.

"If the consumer pays the balance in full, it could result in a 10 percent savings. What happens if they don't? Store cards typically carry an annual interest rate of at least 18 percent; some charge as high as 24 percent. In contrast, many bank credit cards carry interest rates below department store credit card rates," says Consumers Union.

Beware of payment plans that sound too good to be true. Those deferred payment plans that invite you to wait until May or June to pay, or those that offer you to skip a payment or a lower minimum payment should be scrutinized closely.

"Consumers should know the consequences before accepting these tempting offers," says Consumers Union.

## THE FAMILY GATHERINGS

Don't expect perfection at your holiday family gatherings, advises Mark McLeod, director of Emory University's Counseling Center in Atlanta. Avoid the post-holiday blues by keeping realistic expectations.

"We go into the holiday season expecting it all to be warm feelings," says McLeod. "But it isn't ever that way; there are lots of hassles that can create conflict like buying cards and gifts and visiting families. Most of us have to lower our expectations so we don't get disappointed."

Don't expect old tensions or issues to be dealt with and resolved during holiday visits, he says. "Promise yourself to address them during the coming year instead."

And another strategy to smooth a holiday visit is to build in some time when you and your spouse or significant other can talk about how the visit is going. "That time can be very important so no one is feeling overburdened with details," says McLeod.



Recall the Warmth of Christmas Past... Visit Heartland House for a special "Christmas in the Country"



**Specializing in**

- Vintage Furniture
- Howard Miller clocks
- Dept. 56 Villages
- Christopher Radko Glass Ornaments
- Folkstones • Noah's Arks
- Goosefeather Trees
- Byers Choice Carolers
- Miss Fannie Turgeon's Dolls
- Vaillancourt Santas



**Heartland House Country Store**

124 W. Main  
Downtown Brighton  
**229-4039**

Major Credit Cards Accepted  
M-F 10 to 8, Sat. 10-5, Sun. 12-5

*Holly Day Specials*

Deck your halls with our boughs of holly, evergreens and floral arrangements.

For convenient Gift Giving call your order in  
**(810) 437-4168**

**Bakman FLORIST**  
22880 Pontiac Trail  
In King Plaza  
South Lyon

Selling & Accepting Gently Used Quality Designer Fashions for Men, Women and Children. Maternity & Plus Sizes

*Dress Your Best For Less!*

300-450 New Fall/Winter Consignments Received Daily!

**Great Selection of Holiday Fashions!**  
**60%-80% Off Retail!**  
Remember Us for Toys & Accessories for the Home

**Our Blessings**  
Consignment Clothier

328 Summit, Milford  
Behind Middle House  
Between Allstate & Hector & Jimmy's

**684-1594**

Hours: Mon.-Sat. 9 to 5 Except Thurs. 9 to 8

CLAIBORNE • ST. JOHN • SONIA RIKIEL • BICCI • GIRBAUD • ALBERT MIPON • EVAN PICONE • RALPH LAUREN  
ADRIENNE VITTADINI • ANN TAYLOR • JONES NEW YORK • ESCADA • KUPPENHEIMER • STRUCTURE  
LANDS END • GAP • CAROLE LITTLE • DIKY  
UNGARO • OSH KOSH • L. BATES • CHANEL

**20% Off Any One Item at Regular Price**  
1 coupon per customer. Expires 12-25-96

Gift Certificates Layaways

Wrap up your Holiday Gift List with...

**Sanders** SINCE 1875 ... a holiday tradition since 1875

Sanders fine quality Chocolates and Toppings are a perfect fit for everyone on your LIST.

from our...  
Old Fashioned Family Assortment to our Honeycomb Chips ... always a favorite!

or perhaps...  
one of Sanders Fancy Fruits or our world famous Milk Chocolate Hot Fudge Dessert Topping.

Remember... MAIL ORDER - ASK ABOUT OUR CORPORATE DISCOUNTS  
sending Sanders for the holidays ... says it best!

For information ... on mailing those out of town gifts or to find a store featuring Sanders products.. near you.

*Holiday List*

- ...for the house
- ...co-workers
- ...clients
- ... Teachers
- ... Family
- ...out of town relatives...
- ...Aunt Mary in
- ...Uncle Tony in
- ...Tom & Chris
- ...etc.
- ...etc.
- ...etc.

call 1-800-651-7263  
or 1-800-838-5151  
office - Novi, MI 48375

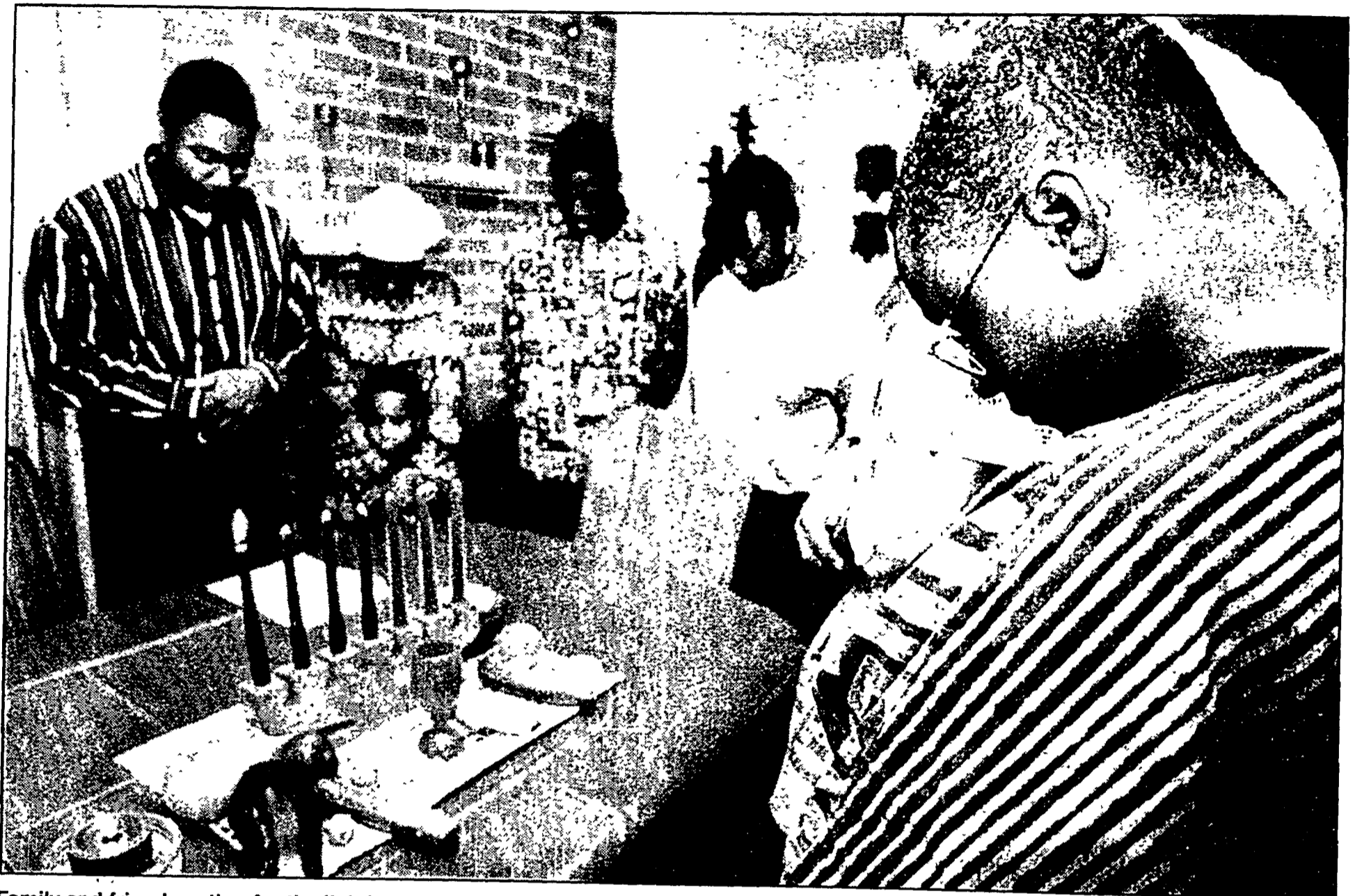

Family and friends gather for the lighting of the Kwanzaa candle and to renew their commitment to the African-American community.

## Kwanzaa celebrations trace roots to Africa

By Priscilla Lister  
Copley News Service

Kwanzaa, the seven-day African-American cultural holiday celebrated Dec. 26 through Jan. 1, has become one of the most important holidays to reaffirm family values.

Created in 1966 by a university professor and cultural scholar, Maulana Karenga, Kwanzaa was inspired by traditional harvest celebrations in Africa.

His vision for the holiday has been "to foster a reunion of African-American families and peoples, to recognize African-American achievements, and to be a time for cultural renewal and rededication to strong family values," say Kathleen Minnick-Taylor and Charles Taylor in their book, "Kwanzaa: How to Celebrate It in Your Home" (Praxis Publications).

Kwanzaa is based on seven principles, each celebrated on its own day during the celebration: umoja, or unity; kujichagulia, self-determination; ujima, collective work and responsibility; ujamaa, cooperative economics; nia, purpose; kuumba, creativity; and

imani, faith.

There are also seven symbols arranged on the Kwanzaa table: a mkeka, or a mat, representing African traditions and foundation; the kinara, a candleholder representing the original stalk of ancestry; mishumaa saba, the seven candles placed in the kinara and one lighted successively each day of the celebration; vibunzi, ears of corn representing the number of children in a family; kikombe cha umoja, a communal unity cup used to share the ceremonial drink; mazao, fruits and vegetables symbolic of products generated from hard work; and zawadi, gifts that represent rewards for outstanding achievement during the year.

On the first day, dedicated to umoja (unity), the Taylor family sits down for dinner while African-American music plays softly in the background.

"Then we prepare to light the candle," say the Taylors. "Next we pass the unity cup, which we usually fill with water or juice. Beginning with the eldest person, each of us briefly tells what umoja means, takes a drink and then passes the cup until all have

drunk. During supper we discuss what we have done to promote unity and what additional things we might do in the future."

During a family activity that first night after supper, the Taylor family creates a family picture board.

"We go through family pictures, talk about our family history, and then work together to assemble a picture board that will stay up the entire seven days of Kwanzaa," say the Taylors.

While the principles and symbols of Kwanzaa are standard, the ways to celebrate the holiday are as varied as any family.

Some followers of Kwanzaa fast from sunrise to sunset during the seven days, says Jessica B. Harris in "A Kwanzaa Keepsake: Celebrating the Holiday With New Traditions and Feasts" (Simon & Schuster), which makes the evening meal more celebratory. Others invite different friends to celebrate throughout the seven days.

Harris, a teacher and author, fills her family's Kwanzaa with inspirational spirits as well. During each evening's ceremony, she selects ancestors whose

lives and accomplishments are shared as springboards for further discussion of each principle.

Many African-Americans wear African-style clothing during Kwanzaa and especially during the karamu feast on the last day, says Angela Shelf Medearis in her book, "A Kwanzaa Celebration: Festive Recipes and Homemade Gifts" (Dutton). Serving the feast African-style, arranging pillows or cushions around low tables, adds a historic touch.

During the karamu feast on Jan. 1, Kwanzaa celebrations may also feature stories, songs, dances and other performances.

"It presents a great opportunity to get children excited about Kwanzaa," says Medearis.

The Taylor family ritual during the third day of Kwanzaa, the principle of which is ujima (collective work and responsibility), involves collective planning of the karamu feast and the special readings and music to be heard



# Bring the whole gang to shop for all your holiday buys in **South Lyon!**



## Forget Me Not Inc.



- Custom Cakes
- Christmas Gifts
- Balloons
- Balloon Stuffing

582 N. Lafayette • South Lyon  
In Huntington Square  
(810) **437-8865**

## Lyon's Book Den

116 E. Lake St. • South Lyon

(810) **437-2500**

**20% Off**

Books and Greeting Cards

with coupon expires 12-8-96

## Christmas Walk

- Visit our Christmas Gift Shop inside the shop
- We will also be at the High School Boosters Craft Show

## The Art Craft Shop

113 N. Lafayette • South Lyon  
(810) **437-3830**

## Mickey's Menagerie

Floral Designs • Silk & Dried  
810-437-3279

## Floral Arrangements & Wreaths for Gift Giving

Shipping available & free gift wrapping

327 N. Lafayette • South Lyon  
(810) **437-3279**



## Santa's Special

Fri. Dec. 6 / Sat. Dec. 7 / Sun. Dec. 8

**1 Large Pizza \$5.99**  
with 1 topping

pick up special ONLY with this coupon

Delivering Quality to a Plate Near You!

*Wishing everyone a*

*Merry Christmas and a Happy New Year!*

294 N. Lafayette • South Lyon • **810 437-8100**  
Hours: Sunday - Thursday 11-11 Friday & Saturday 11-12

## BROOKDALE CLEANERS

*Professional Alterations by Mia*

Same Day Service Available Monday - Saturday before 10am

Quality Dry Cleaning & Shirt Laundry

**20% Off**

Incoming Dry Cleaning Only!

Brookdale Cleaners • expires 12-14-96

Located in Brookdale Square • 22301 Pontiac Trail • South Lyon  
Hours: M-F 7a.m.-7p.m.; Sat. 8a.m.-5p.m. (810) 486-4200

## HealthStyles

PHYSICAL REHABILITATION

301 S. Lafayette • South Lyon, MI 48178

## PHYSICAL THERAPY AND OCCUPATIONAL THERAPY

### SPEECH THERAPY

*Specializing in:*

- ★ Neck & Back Rehabilitation
- ★ Orthopedic • Sports Injuries
- ★ Post-Surgical Rehabilitation
- ★ Pain Management
- ★ Neurological Conditions
- ★ General Rehabilitation

**Ask Your Physician For A Referral**

Most Insurances Accepted including: PPOM, Workers Compensation, Medicare and Blue Cross/Blue Shield

Barbara Herzog, P.T.  
Sandra Jenkins, P.T.

Member of: American Physical Therapy Association, Michigan Physical Therapy Association

**486-1110**

## BI-RITE AUTO SUPPLY

**HUGE SELECTION** of Tools & Gift Sets

**Great Stocking Stuffer ideas!**

**Gift Certificates**

**BUMPER TO BUMPER**

125 E. Lake St. • South Lyon  
(810) **437-6995**



### Christmas Festivities

- 12/6 6:30pm Decorating Tree
- 12/6 7:00pm Tree Lighting
- 12/7 10:00am Parade

Enjoy the festivities throughout the town

### 12/7 Christmas Walk

- Story Reading at Lyon's Book Den
- 12:30 pm at South Lyon Cinema - Rated PG
- "Larger than Life" Starring Bill Murray
- Open House at The South Lyon Fire Dept. and South Lyon EMS
- Santa will be giving free sleigh rides
- Luncheon Specials throughout the town

Bring the whole gang to shop for all your holiday buys in

# South Lyon!



Give the gift... that lasts for life

## Lay Howie

### Hardwood Floors

Nobody knows more about your hardwood floors

- Quality Installations
- Refinishings and Repairs
- Residential • Commercial

call us at: (810) 437-1813

fax us at: (810) 437-1366  
New Hudson, MI - we lay for pay

## MICKEY'S

ICE • KEG BEER • LOTTO • WINE

437-3993

22450 Pontiac Trail at 10 Mile  
Hours: M-Sat 9-12:30, Sun 12-11  
Your Lotto Headquarters • Play The Big Game  
• 27 Instant Tickets In Stock

### Discount Cigarette Center

All Monarch cartons \$14.59	All Winston cartons \$17.22
All Doral cartons \$14.59	All Camel cartons \$17.22
All Basic cartons \$14.59	All Winston Select cartons \$17.22
All Salem cartons \$16.72	

Large Selection of Zippo Lighters

## Serra Interiors

### Decorating Center

- Quality Floor Covering
- Custom Draperies and Blinds
- Wallpaper

The Service You Expect at  
Prices You Can Afford

## 437-2838

116 N. Lafayette

## Cabbage Rose Antiques

### Specializing in Victorian

- Christmas Gifts - Snowmen
- Kaleidoscopes • Antiques

(810) 486-0930

317 N. Lafayette • South Lyon  
www.rust.net/cabrose

## Pat Guy Interiors

- Custom Window Treatments
- Carpeting • Ceramic, Vinyl & Wood
- Designer Wallcoverings and Fabrics
- Custom Area Rugs

Private Design • Consultations by Appt.

(810) 486-5321

South Lyon

## 10% Off

In stock only with this ad expires 12-14-96

### SOUTH LYON PLUMBING & SUPPLY

(810) 486-1288

21001 Pontiac Trail - just north of 8 Mile

- Heating • Plumbing • Cooling
- Water Conditioning

Sales & Service

## South Lyon Fireplace Shop

- Area's largest selection of glass doors and mantels.
- Stop by and visit our showroom to see our new gas & wood burning fireplaces
- Largest selection of top quality gas logs
- Glass doors for all pre-fab / zero clearance fireplaces

228 S. Lafayette • 2 Blocks S of 10 Mile • South Lyon  
Hours: Tuesday - Friday 10:00-6:00, Saturday 10:00-4:00

437-3044/437-0055

Now Leasing

## BROOKWOOD FARMS

### South Lyon's Finest

- 1, 2 & 3 bedroom apts.
- Garages Available

3 bedroom single family homes, full basement, 2 car attached garage

(810) 437-9959

Huntington Sq. 644 N. Lafayette  
In Huntington Square

## CLEANERS

Professional Dry Cleaning & Shirt Laundry

- Alterations
- Leather Cleaning
- Wedding Dress Preservation

Hours: Monday-Friday 8:30 - 7:00; Saturday 9:00-5:00

(810) 486-4700

## 20% Off

Incoming Dry Cleaning Only  
Expires 12-14-96

## SOUTH LYON CYCLE

209 S. Lafayette (Pontiac Trail)  
810-437-0500

One of the Top 100 Bicycle Dealers in the U.S.A.  
Owner Operated with "Over 25 Years Experience"

Complete Selection for Family or Pro

Use our Christmas Layaway

One Day Service Available On All Makes & Models!

1. Island Lake State Rec. Area
2. Kensington Metro Park
3. Maybury State Park

## Walldressers Plus

- Wallcovering Installation • Painting Services
- Custom Artwork Selections

Peggy Adams  
(810) 788-5962

Creativity & Experience Combined

## GREAT LAKES SADDLERY

A Variety of Gift Items for the Equestrian in Your Life!

22271 Pontiac Trail, South Lyon  
Brookdale Square  
(near the corner of Nine Mile and Pontiac Trail)

Hours: Tues - Sat: 10am-7pm; Sun: Noon to 5pm

(810) 437-0555

# DOLLS

## 20-30% OFF

Doll Trunks, American Girl Doll Beds, Doll Desks  
Sale ... November 27 - December 20th

### DEC. 7TH OPEN HOUSE 7TH ANNIVERSARY

Enter to win a special door prize. 9am-8pm

NEW DOLL CLOTHES NOW IN!

## DIANE'S DOLL HOUSE

(On the corner of 10 Mile and Pontiac Trail)

Holiday Hours:  
Mon. - Sat. 11-7; Thurs. 11-8; Sun. 1-5; Closed Wed

102 N. Lafayette • South Lyon (810) 486-0450

Visa, MC, Am Ex, Discover • Layaway

## QUICKSILVER PRINTING CENTER

120 N. Mill St. • South Lyon, MI 48178

810-486-1777 • Fax 810-486-1780

- DESKTOP PUBLISHING
- BUSINESS CARDS
- CONTINUOUS FORMS
- CHECKS
- ENVELOPES
- LETTERHEAD
- FORMS
- AND MORE...

GIFT IDEAS:  
Business Cards  
Calling Cards  
Personalized Stationery  
Note Pads

## Pegasus Antiques & Collectibles

# Holiday Sale!

## 25%

Reduction on most merchandise. Additional 5% with ad.\*

2 Full Floors of Yesteryear! Gas Pumps & Gas Memorabilia, Beverage, General, Paper, Tins, Signs, Pocket & Table Lighters (old & new), Furniture, Glass.

Meet Paws, The Detroit Tigers Mascot & Ronald McDonald at Our  
3rd Annual Christmas Parade  
December 7, 1996 10am  
Free Sleigh Rides with Santa!

Sale Ends 12-31-96

(810) 437-0320

Pontiac Trail & 10 Mile • South Lyon  
Hours: Tues.-Sun. 11am - 5pm; Thurs. till 8pm; Mon. by chance  
Cash, Checks and Charges Cheerfully Accepted  
\* see shop for details

coupon • coupon • coupon • coupon

## One Extra Year of Service

# FREE

with the purchase of any water softener unit

coupon • coupon • coupon • coupon

coupon • coupon • coupon • coupon

## BOTTLED WATER

# FREE TRIAL OFFER!

FREE 30-DAY TRIAL!  
FREE 15 GALLONS!  
FREE DELIVERY!

CALL NOW!

Offer available to new customers only. Bottle deposit and credit check required.  
With this coupon • Absolutely Expires 12-31-96  
Cannot be combined with any other offer or discount

coupon • coupon • coupon • coupon

810-437-9136 | 313-449-8722

Call Us Anytime! Mon. - Fri. 9-6; Sat. 9-4

## COUNTRY WATER TREATMENT

13658 W. Ten Mile • South Lyon

Locally Owned & Operated

### Sales, Salt & Service

Bring the whole gang to shop for all your holiday buys in

**South  
Lyon!**



**Paint 'n  
Paper** Plus

*Finishing Touches*

117 N. Lafayette • South Lyon  
(810) 486-4910

♥ Arrangements ♥ Antiques ♥ Gifts

♥ Home Accessories ♥ Christmas Trims

Let us help  
you with your  
gift giving &  
decorating  
this holiday  
season!

**South Lyon** **K40** Full Service  
**ELECTRONICS** CB Radio Shop  
104 N. Lafayette • South Lyon  
Electronics Sales & Service 810 437-7440

Cellular Phones & Cellular Phone Activation Packages

**Hand Held**  
Rechargeable  
Spotlight  
**\$39.95**

**CB  
Radio**  
**\$39.00\***  
\*Factory Serviced

**All  
Cobra CB  
Radio's on  
Sale**

**Special  
Pagers  
on Sale**  
**\$39.95**  
Free Activation  
Save \$60.00



Make Christmas Dreams Come True

*Hallmark Cards*

**Geri's Hallmark**

22371 Pontiac Trail • South Lyon

810 437-5319

Located in Brookdale Square  
just South of 9 Mile

Give the gift of  
**Travel  
Certificates**

Call now  
and save!

**Phillips Travel  
Service, Inc.**

110 N. Lafayette  
South Lyon, MI. 48178-1297

810 437-1733

Call Toll Free

1-800-783-2019



**Saturday December 7th Only**

**25% Off** All Christmas Items!  
excludes sale items

**Free Popcorn**

**Porcelain Buildings**

Hand-painted buildings feature 6' cord and bulb.  
Build your own collection. Assorted Styles.

**Sale  
Price** **\$9.88**



**South Lyon Lumber** **ACE**

415 E. Lake St South Lyon

**HARDWARE**

**(810) 437-1751**



Where  
Santa Shops for  
Computers!

**COMPUTERIZE Inc.**  
IBM COMPATIBLE COMPUTERS

CD ROM  
8X-\$130  
10X-\$200  
12X-\$250

- DIGITAL DISPLAY CASE • MIN OR DESKTOP
- 3.5" or 5.25" FLOPPY DRIVE
- 2 SERIAL/ PARALLEL PORTS
- 8 MEG RAM • 16 RAM ADD \$60
- 104 KEY W/NUM STYLE KEYBOARD
- SVGA 14" COLOR MONITOR 28CP NON-PT
- SVGA VIDEO CARD 1 MEG RAM PCI
- 256K PIPELINED CACHE MOTHERBOARD
- 850 MEG HARD DRIVE-1.2 GIG ADD \$50
- 3 YEAR WARRANTY PARTS AND LABOR



ADULT  
CD ROMS  
IN STOCK

90 DAYS  
NO PAYMENT

WE MEET OR BEAT  
COMPETITION PRICES

RAM SALE  
1.5GB 5999 530  
2.5GB 5999 530

PENTIUM-75	PENTIUM-100
\$850	\$875
PENTIUM-120	PENTIUM-133
\$900	\$950
PENTIUM-150	PENTIUM-166
\$1000	\$1150
PENTIUM-200	PENTIUM PRO-200
\$1450	\$1800

MULTIMEDIA STARTING AT \$150 CALL  
• Software • Accessories • Service • Delivery • Financing

15076 MIDDLEBELT, LIVONIA

313-427-0102  
Mon.-Fri., 10-8 • Sat., 10-6 • Closed Sun



**MERRI-SEVEN  
TRAINS & HOBBIES**

19155 Merriman At 7 Mile Rd.

Livonia, MI 48152

(810) 477-0550

- Buy • Sell
- Trade • Repair
- All Gauges of Trains
- Doll Houses
- Miniature Furnishings
- Model Kits
- Collectible & Antique Toys



Now carrying  
wooden railways  
for children by Brio

*Give the Gift of Golf!*

## Season Pass

*for '97 Golf Season*

**\$600<sup>00</sup>    \$900<sup>00</sup>**

Single                      Couple

**Gift Certificates! Any Denomination!**

**Book Your  
Holiday Party Now!**

No party too small

**ALL YOU CAN EAT! No Carryouts! ALL WINTER!**

Join us for our  
Fish Fry

**\$6<sup>45</sup>**  
only

Dinner Includes: • Baked or Fried Cod  
• Cole Slaw • French Fries • Roll & Butter

Saturdays 5-10 pm

**CRAB LEGS**

**\$14<sup>95</sup>**

**Pebble Creek Golf Club**

24095 Currie Road (810) **437-5411**  
South Lyon

# A Bird Lover's Holiday

Let us help you share you love of  
nature with gifts that gladden  
the heart.

We have the perfect gift for your favorite bird lover!

## Wild Bird Centers

located in Traver Village  
2625 Plymouth Rd. • Ann Arbor, MI  
Mon.-Sat. 10-6, Sun. 12-5

### 213-BIRD (2473)

# Kwanzaa celebration reaffirms family values

Continued from 26

that night.

"Children from our extended family make plans to present a special skit for the festival," say the Taylors. "They select a theme based on the principle of ujima. ... This evening reminds all of us of the joy and strength we gain by working together."

A project suggested by Harris in her book for the third night of Kwanzaa asks that in creating a potluck supper for family and friends, each person bring a second dish to be shared with a homeless shelter, AIDS hospice, senior citizens' center or other group of your choice. Take the children when you take the dishes and "establish the tradition of collective work and responsibility."

But perhaps above all, "Kwanzaa is also a time of feasting, of rejoicing, of savoring friendships and ties with family, or renewing commitments. Part of that communion of family and friends takes place around the table and the communion of the table is a good part of the warmth of the holiday," says Harris.

With that thought, consider adding these recipes to your own Kwanzaa traditions.

"This dish was one of the first African dishes that I tasted and it was truly love at first bite," says Harris. "I often double this recipe because yassa is even better the next day. It also freezes well."

## SENGALESE CHICKEN YASSA

1/4 cup fresh lemon juice  
4 large onions, thinly sliced  
Salt to taste  
Freshly ground black pepper to taste  
1/8 teaspoon minced fresh habanero or other hot chili, to taste  
1/4 cup plus 1 tablespoon peanut oil (divided use)  
1 (2-1/2 - to 3-1/2 -pound) chicken, cut into serving pieces  
1 habanero or other hot chili, pricked with a fork  
1/2 cup pimento-stuffed olives  
4 carrots, scraped and thinly sliced  
1 tablespoon Dijon-style mustard  
1/2 cup water  
Yields 6 servings.  
In large nonreactive bowl, prepare

marinade with lemon juice, onions, salt, pepper, minced chili and 1/4 cup peanut oil. Place chicken pieces in marinade, making sure all pieces are well covered, and allow them to marinate for at least 2 hours in refrigerator.

Preheat broiler. Remove chicken pieces, reserving marinade, and place them in shallow roasting pan. Broil until lightly browned on both sides. Remove onions from marinade.

Cook onions slowly in remaining 1 tablespoon oil in flameproof 3-quart casserole or Dutch oven until tender and translucent. Add remaining marinade and heat through.

When liquid is thoroughly heated, add broiled chicken pieces, pricked chili, olives, carrots, mustard and water. Stir to mix well, then bring yassa slowly to a boil. Lower heat and simmer for about 20 minutes or until chicken is cooked through.

Serve hot over plain white rice.  
(From "A Kwanzaa Keepsake.")

"This recipe greatly reduces the fat normally added to collard greens, but it keeps the flavor," says Medearis.

## NEW-STYLE COLLARD GREENS

2 bunches (about 4 pounds) collard greens  
6 cups water  
2 pounds smoked turkey wings, cut at joints  
2 teaspoons salt  
1 or 2 dried red peppers OR 1/2 teaspoon ground red pepper (cayenne)  
1 clove garlic, mashed  
1/2 teaspoon sugar  
1 tablespoon olive oil  
Yields 8 servings.

Cut tough stems and yellow leaves from collard greens and discard. Gently rub leaves with your fingers under warm running water. Cut greens into large pieces. Let leaves soak in warm, salted water for 10 minutes. Rinse with cool water and drain in colander.

In large pot, bring water to a boil. Add collard greens, smoked turkey wings, salt, red pepper, garlic, sugar and olive oil. Reduce heat, cover and simmer over low heat for 1 to 2 hours or until greens are tender.

Stir occasionally and add hot water to cover greens as needed.  
(From "A Kwanzaa Celebration.")



Create Your Magic At The



**Winter Bridal Sale**

20%-50% OFF Selected Wedding Gowns  
30%-75% OFF Selected Holiday Evening Gowns  
20% OFF Your Wedding Accessories  
25% OFF Invitation Order

Wedding Special

**All Tuxedos \$59<sup>00</sup>**

Sale ends Jan. 31, 1997

Winter Cape Rental Available

115 E. GRAND RIVER • HISTORIC DOWNTOWN HOWELL  
**(517) 548-4708**



Open Thanksgiving Day!



Visit **Broadview Christmas Tree Farm**

Experience... all the charm & outdoor adventure of an old-fashioned winter hayride. Walk among our evergreens & choose your own special tree, perhaps one with a limb which might have given cover or a gap which offered a warm resting place to the many rabbits, birds, deer & other living creatures on our farm.

Celebrate... fifty golden years of memories on our 100-acre tree plantation. Enter the warmth of our barn where you can gather to eat, visit and enjoy the spirit of tradition.

Only \$25 for Scotch Pine, \$35 for standard size Spruce, \$45 for Blue Spruce & \$55 for Douglas Fir. Other sizes specially priced. Free shaking. Available: pre-cut trees from \$9 to \$90. roping, wreaths, tree stands.

Coupon! Bring this ad & save \$2.00



4380 Hickory Ridge Road, Highland, 3 miles north of M-59  
Beginning Thanksgiving Day, 7 days a week, 9 AM - 5 PM • (810) 887-TREE or 887-4865

# Kitchen For Family Gatherings... Cuisinart

The Cook's World® ... for the holidays and everyday!

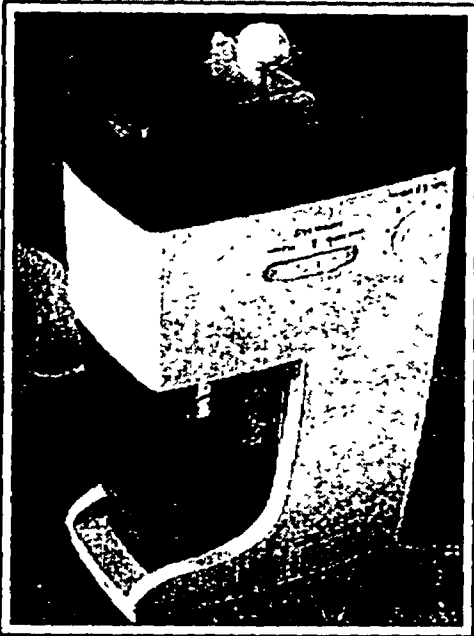

**CREATE YOUR OWN CLASSIC BLEND - CUISINART COFFEE BAR COFFEE MILL**  
Imagine being able to blend aromatic Kona with full-bodied Espresso beans... or creating your own special decaffeinated and caffeinated blends, with the Cuisinart Coffee Bar™ coffee mill. The combinations are limitless! It's the only coffee mill with dual whole bean chambers.  
Mfr. sugg. retail \$89.99 144 units  
**Sale \$69.99**

**FREE GIFT WITH PURCHASE!**  
Two Mugs (not shown)



**CUISINART AUTOMATIC 12-CUP COFFEE MAKER**  
The Cuisinart 12-cup automatic coffee maker brings rich, full-bodied coffee bar flavor into your home. This ultimate coffee maker includes adjustable auto shut-off, a "time to clean" monitor, self clean function, and programmable coffee holding temperature. Plus, an extra-large LCD clock and temperature display. Gold tone filter included. 3-year limited warranty. 144 units  
Available in WHITE or BLACK Mfr. sugg. retail \$119.99  
**Sale \$89.99**

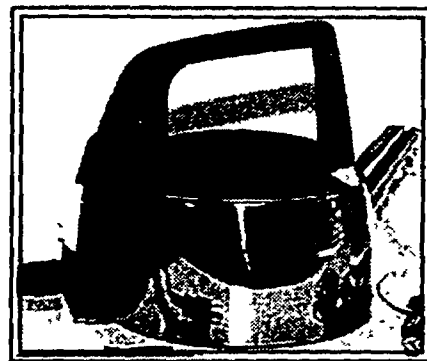

**CUISINART ELECTRIC WARMING POT**  
Keeps water hot and ready when you need it. Great for tea! All stainless steel. Heat resistant handle. 1 3/4 quart.  
Mfr. sugg. retail \$96.00 144 units  
**Sale \$69.99**

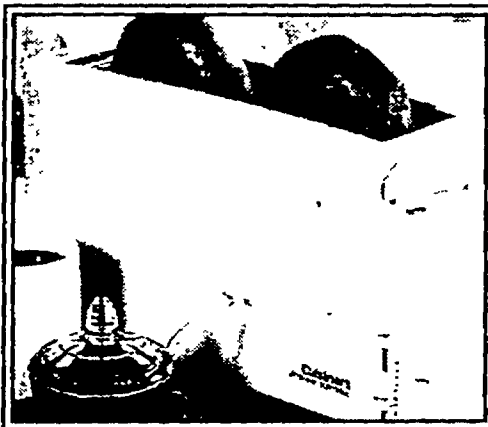

**LARGE ENOUGH FOR BAGELS! CUISINART TOASTER**  
Cuisinart's two-slice toaster offers a selection of 10 toasting cycles with a cancel button and the unique heat-surround feature for even results every time. The carriage rises close to the top for easy removal. You'll love the slide-out easy-clean crumb tray. Black or White (shown) 144 units  
Mfr. sugg. \$60.00  
**Sale \$39.99**

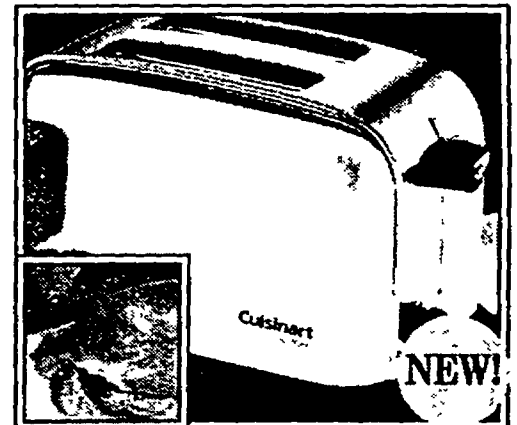

**CLASSIC STYLE & ELEGANCE - CUISINART CHROME TOASTER**  
Large toasting slots hold a variety of breads, including muffins and bagels. Toasts lifts to top of toaster easily remove even small items. Sets toast color from dark to light for perfect browning. Defrosts - Reheats - Slide-out Crumb Tray - Cord Storage. 18-month warranty. 144 units  
Mfr. sugg. retail \$75.00  
**Sale \$49.99**

## EVERYDAY COOKWARE

**CUISINART YOUR CHOICE SALE Only \$49.99 each!**



2-QT KETTLE \$80.00 Value 144 UNITS  
2-QT CASSEROLE & COVER \$85.00 Value 144 UNITS  
3 1/4-QT SOUP POT & COVER \$110.00 Value 144 UNITS  
9 1/2" GRATIN & COVER \$98.00 Value 144 UNITS  
2-QT NON-STICK SAUTE PAN \$120.00 Value 144 UNITS

**FREE GIFT!**  
7 1/4" SKILLET FREE WITH PURCHASE! (not shown)



**◀ CUISINART EVERYDAY 7-PC. COOKWARE SET**  
All Cuisinart Cookware can be placed in the oven and under the broiler. Cuisinart Stainless Steel Cookware will give you a lifetime of service and unequalled results. Great heat conduction and dishwasher-safe too! The set includes: 2-qt. deep sauce pan w/cover, 2 3/4 qt saucepan w/cover, 10 1/4" dutch skillet pan, 7-qt dutch oven stock pot w/cover. 96 sets.  
Mfr. sugg. retail \$380.00  
**Sale \$199.99**



**7-PC. NON-STICK STAINLESS STEEL COOKWARE SET**  
Cuisinart has combined non-stick convenience with professional quality performance to create a new standard in stick-free cookware that contains absolutely no aluminum. Now you can enjoy uncompromising cookware specially design for flavorful and healthy cooking. Includes 8" skillet, 2-qt sauce pan w/lid, 3 1/2-qt saute pan w/lid, 5-qt stock pot w/lid (fits 8" skillet). Includes free 7" skillet! Mfr. sugg. retail \$480.00  
**Sale \$249.99**  
96 sets

**FREE 7" SKILLET!**  
with purchase of set

**GIFT WITH PURCHASE!**  
**CUISINART CUSTOM II**  
This Cuisinart Custom II food processor has a durable motor and large feed tube. Includes large work bowl, stainless steel blade, dough blade, and slicing and shredding discs. 11 cup capacity. Bonus: 2-ml slicer disc, flat cover and a how-to video free with purchase. Limited quantity. 144 units.  
Mfr. sugg. retail \$300.00  
**Sale \$199.99**

**CALL 1-800-641-1252 FOR ALL YOUR HOLIDAY NEEDS**

**FREE SCALE WITH PURCHASE!**

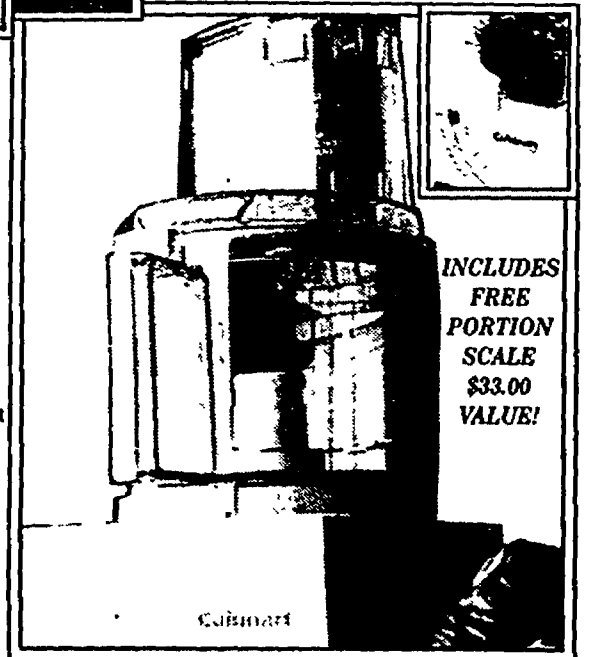

**INCLUDES FREE PORTION SCALE \$33.00 VALUE!**

## DROP BY FOR OUR SALE HOLIDAY GUIDE

VISA  
MASTERCARD  
DISCOVER  
AMERICAN EXPRESS

Novi  
Novi Town Center  
SE of I-96 Novi Exit  
810-380-8600

REDFORD TOWNSHIP  
26770 Grand River  
Btwn. Inkster & Beech  
313-537-1300

ROCHESTER  
Great Oaks Mall  
Walton & Livernois  
810-652-0402

W. BLOOMFIELD  
Orchard Mall - NE Corner  
Maple & Orchard Lk. Rd.  
810-855-4466

**SHOP BY PHONE OR DROP BY ANY LOCATION**  
1-800-641-1252



**SALE ENDS DECEMBER 24, 1996**



**MAKE THEIR CHRISTMAS THE BEST EVER!**  
from  
**THE MUSIC MAN**

**AREA'S LARGEST SELECTION OF GUITARS, DRUMS, AND P.A.s**

- GIBSON
- MARTIN
- PEAVEY
- IBANEZ
- WASHBURN
- TAKAMINE
- SEAGULL
- HERITAGE
- G & L
- SIGMA
- TAYLOR
- DOBRO
- CRATE



**GUITAR GIFT PACKS**  
from  
**\$179<sup>99</sup>**

**SPECIALS**

KORG GT-3 REG \$40<sup>99</sup> NOW **\$24<sup>99</sup>**  
ELECTRONIC GUITAR TUNER

IBANEZ TM5 THRASHMETAL Distortion Pedals  
REG \$59<sup>99</sup> NOW **\$39<sup>99</sup>**

ZOOM MULTI-EFFECT GUITAR PROCESSORS  
**STARTING AT \$139<sup>99</sup>**

"ACOUSTICALLY WE'RE A SOUND INVESTMENT"

PEARL, TAMA, SUNLITE AND TKO  
**Complete Drum Sets**  
including cymbals and stands from **\$359<sup>99</sup>**

- Sheet Music
- Accessories

Hours: Mon-Fri 11-8, Sat 11-6, Sun 12-5

331 W. Main  
**DOWNTOWN BRIGHTON**  
(810) 227-9440  
and  
27466 Plymouth Road  
Livonia, MI (313) 522-3071

**GIFT GUIDE**

**Tokens for the workplace**

Continued from 7

marketing value of promotional gifts. Manning said, and a small, but growing, segment of the business world is expecting a gift from you each December. And why not? The T-shirt you send them is also a cheap ad for your company, so everybody stands to gain, right?





Recent surveys indicate that while

clothing articles are still the most popular promotional business gifts around, times are changing.

"Distributors are seeing a lot of sales on technology items that are going to be used as business gifts," Manning said. "We've seen that increase a lot in the past couple of years. We've seen the prepaid phone cards a lot and compact discs that you can put a holiday greeting on with music that follows it."

**Husqvarna**  
**FALL CLEARANCE SALE**  
All prices drastically reduced!

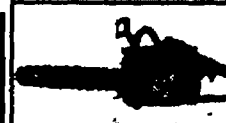
**FREE** Case with every chainsaw purchase

 <b>MODEL 36</b> • 2.2 cubic inch (36cc) engine delivering 2.2 h.p. • Air Injection so the saw runs up to 20 times longer between filter cleanings and changes • 16 inch bar & chain <b>SALE \$199</b>	 <b>MODEL 41</b> • 2.4 cubic inch (40cc) engine delivering 2.5 h.p. • Air Injection • 16 or 18 inch bar and chain <b>SALE \$239</b>	 <b>MODEL 55</b> • 3.2 cubic inch (53cc) with 3.3 h.p. to handle heavier loads • Very easy starting saw, thanks to Husqvarna's smart start technology & the saw's combination choke/air filter • Runs clean & cool thanks to extra large air intake & filter <b>SALE \$349</b>	 <b>MODEL 262</b> • 3.1 cubic inch (52cc) delivering 3.1 h.p. nearly 25% more power than similar sized saws • Exclusive smart start decompression valve ensures easy starting • New environmental of pump delivers oil only when the chain rotates. <b>SALE \$579</b>
---	--	---	--

**BAKER'S LAWN & LEISURE**  
1155 S. Milford Rd. (1 mile South of M-59) Mon.-Fri. 9-6; Sat. 9-4  
(810) 887-2410

**Learn While You Play At**

**The Purple Cow**

**Educational Toys For All Ages**

570 N. Lafayette  
Huntington Square, South Lyon  
(810) 486-3890

3603 E. Grand River  
Wal-Mart Plaza, Howell  
(517) 545-0176

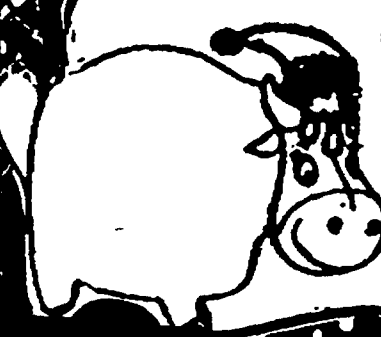

**CHRISTMAS**

*It's that special time of the year!*

**Help Us Celebrate!**

<p><b>Fresh Cut Trees</b></p> <ul style="list-style-type: none"> <li>• Scotch Pine</li> <li>• Fraser Fir</li> <li>• Douglas Fir</li> </ul> <p><b>Hand Tied Roping</b></p> <ul style="list-style-type: none"> <li>• White Pine • Cedar</li> </ul>	<p><b>Cemetery</b></p> <ul style="list-style-type: none"> <li>• Blankets • Wreaths • Cones</li> </ul>
<p><b>Fresh Made Wreaths</b></p> <ul style="list-style-type: none"> <li>• Balsam • Douglas Fir</li> <li>• Mixed Greens</li> </ul>	<p><b>Poinsettias</b></p> <p>What better way to say "Merry Christmas" than with a festive Poinsettia?</p>
<p><b>Ribbon</b> - by the yard 100's of Patterns to choose from <b>Custom Bows</b></p>	<p><b>Also Available</b></p> <ul style="list-style-type: none"> <li>• Artificial Trees, Wreaths, Garland, Plain &amp; Decorated</li> <li>• Lights &amp; Ornaments</li> </ul>

**RANEY'S Rainbow Gardens**  
57707 Ten Mile and Milford Road  
South Lyon Phone 437-2856



# Gift Baskets



They make great gifts for the holidays!

## #1-COLASANTI'S EXTRAVAGANTE

Fit for royalty, this bountiful harvest is overflowing with superb, tantalizing fancy fruit bursting with freshness and gourmet cookies. Garnished with the finest imported chocolates and nuts, the Extravagante says it all.

**\$99.00**

## #2-FAMILY FAVORITE

A fruit lover's paradise! A generous, exquisite assortment of seasonal exotic fruit to satisfy the palate of everyone in the family. Filled from top to bottom with tantalizing fruit, a gourmet Danish ham and many more special delicacies. A delicious gift!

**\$62.50**

## #3-GOURMET GALORE

A basket of gourmet goodies built upon layers of fresh delicious fruit, topped with a savory pineapple, specialty popcorn, shortbread cookies, a Danish ham, the finest cheese, crackers, chocolates and award-winning jelly. A very tasteful gift!

**\$58.00**

## #4-DRY AND DELICIOUS

Toppling over with a variety of the best nonperishable gourmet items, this basket is sure to please. The very best pasta and pasta sauce, the tastiest Gouda cheese and table crackers, Looza fruit juice, cocoa mix, Germack nuts, gourmet cookies and fresh table mints make this basket the perfect gift that will last and last.

**\$36.95**

## #5-THE PREMIER BASKET

Expertly designed, hand-packed top quality fresh fruit rising to a savory summit of plump, juicy pineapple. Sprinkled with the finest imported chocolates.

**\$37.50**

## #6-MICHIGAN HARVEST

A variety of the finest delicacies from our great state. This basket is overflowing with a gourmet assortment of Michigan's best pasta and pasta sauce, Greek dressing, Mucky Duck mustard, homemade peanut butter and Germack nuts. We top it off with pure Michigan honey and the best of Michigan's dried cherries, cranberries and blueberries along with McGuire's famous hot fudge. Say YES! To Michigan!

**\$50.00**

## #7-FRUIT FANTASY

Feast your eyes on this fantasy of fancy fresh fruit. Tease your taste buds with gourmet crackers and cheese along with a succulent Danish ham topped off by choice delicious chocolates.

**\$45.00**

*"All of us at Colasanti's look forward to your visit. Bring the Family"*



468 S. MILFORD RD., HIGHLAND, MI 48357  
(810) 887-0012  
Fax (810) 889-2643

## #8-ALL OCCASION

A beautiful, sturdy dark willow basket is the perfect adornment for this specialty gift. An assortment of the freshest fruits featuring a plump, perfect pineapple, gourmet crackers, imported cheese and a bottle of the finest nonalcoholic wine. A thoughtful gift for any occasion, guaranteed to be a smashing success!

**\$70.00**

## #9-THE LITTLE RED WAGON

A Radio Flyer wagon presents an appealing gift of premium, succulent fruit sprinkled with a variety of fine imported chocolates and tasty lollipops. The wagon is unique as a home decoration or a child's toy.

**\$37.50**

## #10-A FRUITFUL ADVENTURE

A beautiful wicker bread basket balances a tasty tower of fresh succulent fruit covered with the finest gourmet shortbread cookies and crowned with a plump, juicy pineapple. Garnished with imported chocolates.

**\$40.00**

## #11-GOURMET CUISINE

A basket toppling over with gourmet goodies! We begin with a layer of fancy fresh fruit followed by a succulent Danish ham, the finest cheese, award-winning jelly, and gourmet popcorn, crackers and chocolates. A delightful, taste tempting treat!

**\$30.00**

## #12-SOMEONE SPECIAL

A perfect tribute to that especially important person. Filled with fresh, plump fruit, gourmet cookies and the finest imported chocolates, this basket will delight and impress.

**\$27.50**

## #13-POPULAR PIZAZZ

This popular basket is replete with an enticing array of top quality fancy fresh fruit, a delicious perfect pineapple, gourmet cheese and crackers and an assortment of the finest imported chocolates. A positively popular gift!

**\$35.00**

## #14-THE FARMER

A colorful basket filled with extra fancy red and golden delicious apples, premium pears, accompanied by the juiciest sun-kissed oranges. A delicious and healthy gift!

**\$25.95**

## #15-THE LITTLE FARMER

A slightly smaller version of our popular Farmer basket.

**\$17.00**

Visit Our Full Service  
**FLORAL SHOP**  
inside Colasanti's.

ALSO  
• CHRISTMAS TREES  
• HOLIDAY WREATHS • GRAVE BLANKETS  
• CRAFT SUPPLIES

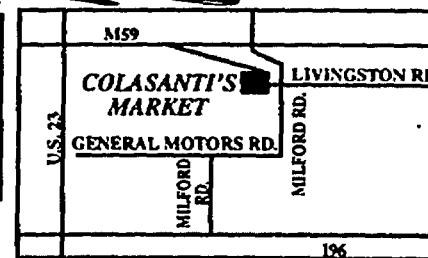

**"HAPPY HOLIDAYS"**

**ORDER FORM**

PERSON PLACING ORDER		UPS SHIPPING AVAILABLE	
Name _____	To _____	Address _____	
Address _____	Address _____		
City _____ State _____	City _____ State _____		
Phone # _____	Zip code _____		
Basket# 1 _____ 6 _____ 12 _____	Phone # _____		
2 _____ 7 _____ 13 _____	Memo for Card _____		
3 _____ 8 _____ 14 _____	_____		
4 _____ 9 _____ 15 _____	_____		
5 _____ 10 _____	_____		
Date to be picked up _____	_____		
Date to be shipped _____	_____		
Date to be delivered _____	_____		
Bankcard # _____	_____		
Expiration Date _____	_____		



Refreshments  
Gift Certificates  
Gift Wrapping

**CLOTHES EXPRESSION**

Contemporary clothing and jewelry for women

**UP COMING EVENTS:**

**Dec. 10 - "TRUNK SHOW"**  
12 - 7 pm "Artclothes"  
by Jennifer Sly-Kirk

**Dec. 11 - "MEN'S NITE"**  
7 - 9 pm  
Let us help the "Santa in your life"  
pick out the perfect gift.

**HOLIDAY HOURS:**  
Mon. - Fri. 10AM-7PM,  
Sat. 10AM-5PM, SUN. NOON-4PM

9864 E. Grand River Ave.  
Grand Crossing Center (Next to VG's) Brighton  
**(810) 227-7566**

**EXTENDED HOURS  
NOW IN EFFECT  
AT THE MOST  
UNIQUE TOY &  
GIFT STORE**

Brio • Safari  
• Breyer • Gund  
Playmobil • Applause •  
• Darda • Tommy  
• Thomas Tank  
• Ravensburger  
• Geo Safari  
Wood Board Games,  
3D & Other Puzzles  
Unique, Unusual and Educational  
Toys & Games For All Ages

**Ultimate  
TOYS & GIFTS**

107 N. Center St., Northville.  
Hours: Mon.-Fri. 10:00am - 8:00pm  
Sat. 10:00 am - 6:00 pm, Sun 12:00 pm-4:00pm  
(810) 305-9990

Watch for Weekly  
Discount Specials  
Throughout the  
Holiday Season

**Beaty's Florist & Greenhouses, Inc.**  
Family owned & operated since 1940  
13790 Highland Rd. (Between Milford Rd. & US 23)

**CHRISTMAS OPEN HOUSE**  
Saturday, Nov. 30 9 a.m. - 5 p.m.  
Sunday, Dec. 1 10 a.m. - 3 p.m.  
• Refreshments • Door Prizes  
• Free Gift With Purchase

Fresh Wreaths; Roping & Grave Blankets  
Poinsettias - all sizes  
Christmas Collectibles & Novelties

**887-1411** Holiday Hours: M-F 9-6; Saturday 9-5; Sundays 10-3 (Starting Dec. 1)  
\*We accept all major Credit Cards\*

Don't Forget Your  
Special Pet at  
Christmas!

- Pet Supplies
- Wild Bird Seed
- Dog Food
- Cat Food
- Horse Feed
- Poultry Feed

**GRAND RIVER EQUINE FEEDS**  
51680 Grand River • Wixom • (810)348-8310

**Santas Everywhere Deserve  
FLEX-A-BED**

**30% OFF**



offer expires  
12/25/96

This Christmas do something for yourself!  
Stop by your Flex-a-Bed dealer and discover  
the comfort you deserve. Two models to  
choose from at affordable prices.

**"Since 1981"**  
**FLEX-A-BED**

LOUNGE RELAX READ SLEEP

**Huron Valley Home-Care Supply Inc.**  
2461 E. Highland Road, Highland, MI  
810-887-6608

**Personalized Children's Books  
Make Reading Fun**

**Disney Titles**  
The Lion King, Winnie the Pooh, Snow White, The Hunchback of Notre Dame, Mickey Mouse, 101 Dalmatians and more!

**Other Titles**  
Sesame Street, Power Rangers, Superman and Wonder Woman, Barbie, Mother Goose, NFL Super Bowl and more!

**Book Styles**  
Custom bound, sticker traditional books, sticker pop-up books and sticker lift flap books

Your child, grandchild, niece or nephew will enjoy reading more when they are the star of the story.

Call, fax or write for free catalog

**The American Book Company**  
43422 West Oaks Drive, Suite 202  
Novi, MI 48377-3300  
Tel: 810-380-7027  
Fax: 810-347-1890

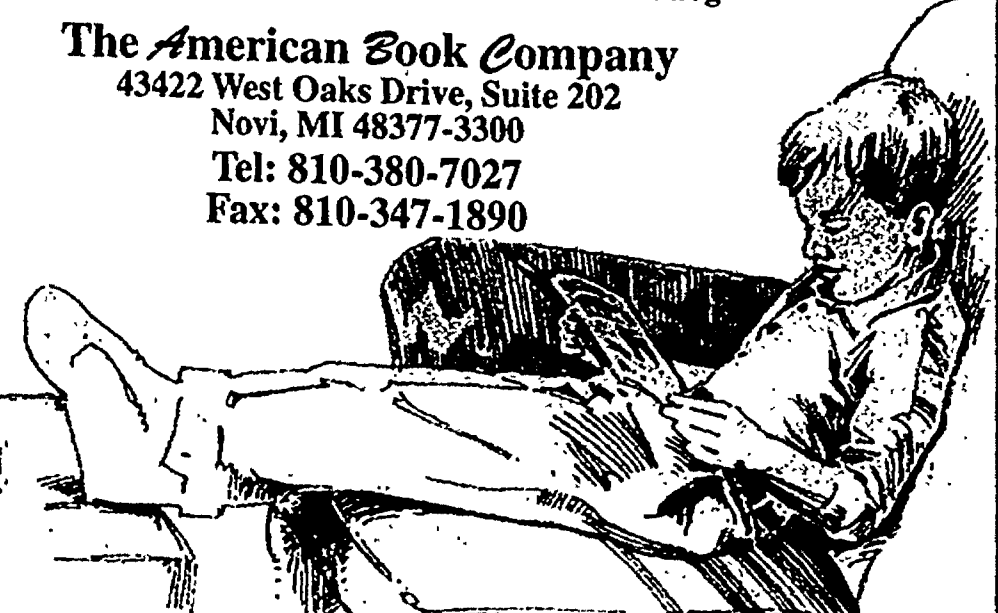

# Have A Real Tree Merry Christmas



**LIVE POTTED  
CHRISTMAS TREES**

**&**

**FRESH CUT  
TREES**

**POINSETTIA SALE**

6" Pot **\$7.99**  
Reg. \$12.99

Larger Sizes Available • Hurry, only 200 available  
With Coupon • While Supplies Last

**Roping Special**

6" Cedar **\$29.99**

Reg. \$34.99  
With Coupon • While Supplies Last



Beautiful  
**Holiday Wreaths**

16" - 7 Ft.

Memorial  
**WREATHS & BLANKETS**

Starting At **\$22.99**



**ALSO AVAILABLE:**

*Fresh Holly Branches, Cones, Boughs, Bows, Boxwood, Fresh Greens, Door Swags, Custom Bows*

**STEINKOPF  
NURSERY**



20815 Farmington Road  
(One Block North of 8 Mile)  
Farmington Hills

**(810) 474-2925**

**Holiday Hours:**

Mon.-Sat. 8 a.m.-9 p.m.  
Sun. 10 a.m. 6 p.m.  
Delivery Available

It's beginning to look alot like a  
Country Christmas!

**Christmas Open House Dec. 6 & 7**



**Gift & Collectibles**  
Christmas Room  
Afghans  
Potpourri  
Yankee Candles  
Fenton Glass

**Great Room**  
Curios  
Gliders & Rockers  
Roll Top Desks  
Oak Accessories  
Grandfather Clocks

over 35 collectible lines  
Holiday Hours: Mon. - Fri. 9-8, Sat. 9-6

**Touch of Country**



3460 M-59 • Howell  
Half way between Howell & Hartwood on M-59  
(517) 546-5995

**LIBRARY SPORTS PUB & GRILL**

Buy 1 Entree get 2nd  
Entree 1/2 Off  
for equal or lesser value  
Dine in only  
coupon

We wish you and your family a  
safe & happy holiday season

(810) 349-9110  
carry-out available.

42100 Grand River • Novi  
in the McLaughlin's Center  
across from Marty Feldman  
Chovy (formerly Shields Pizza)

**CHRISTMAS TREES**

YOUR CHOICE FROM GOOD SCOTCH PINE  
SPRUCE, DOUGLAS FIR  
BEAUTIFUL TREES TO 12 FEET!  
ALL U CUT TREES \$30  
PRE CUT TREES \$15 & UP  
Ask about our \$19 special



10% OFF  
to  
Senior  
Citizens  
exp. 12/24/96

US 23	FENTON RD	TIPSON RD	4235 MIDDLE MILE	HICKORY RIDGE	MILFORD RD
	BRIGHTON	M-59	U CUT FARM		



SAVE 20%  
With this  
coupon  
Mon.-Fri. only  
exp. 12/24/96

OPEN 7 DAYS • (810) 887-1494

NEW  
USED  
RENTALS



FICTION  
NON-FICTION

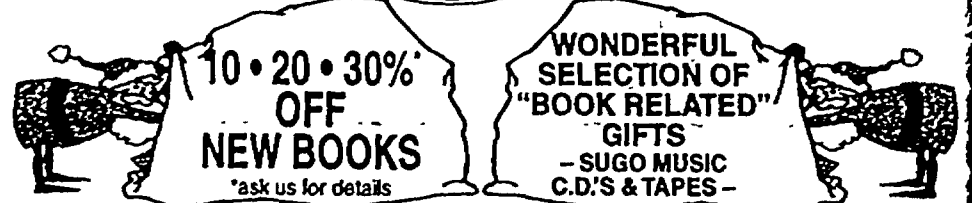

**GIFT CERTIFICATES**

make great stocking stuffers for the readers in your life  
39733 Grand River, Novi, MI 48375 810-474-6066  
Pheasant Run Plaza  
(W. of Haggerty)

Hours Mon.-Fri. 10-8  
Sat. 10-6 Sun. 11-4

**Avoid the Christmas Rush...  
Shop Early and Save!**

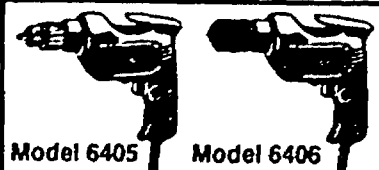

Model 6405 Model 6406  
• high speed, variable speed (0-2, 100 RPM)  
• drills 1/2" in steel, 3/4" in wood • powerful 3.3 AMP  
motor • lightweight (3.1 lbs) and well balanced  
• reversible for removing screws • built-in belt clip  
• all ball bearing construction for durability and  
long tool life • double insulated  
**\$ 57.99 your choice**



Model B04552  
• for a variety of heavy duty uses • features  
grippable clamp lever for easy sandpaper  
installation • palm grip design for easy handling  
• powerful 1.5 AMP motor  
• 14,000 OPM • dust bag for  
clean and efficient sanding  
• lightweight 2.1 lbs. design  
**\$ 49.99**

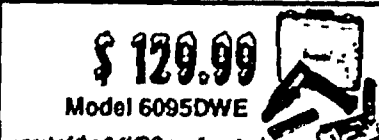

**\$ 129.99**  
Model 6095DWE  
• part of the 9 6VDC cordless tool  
system • equipped with double voltage (9.6V &  
7.2V) charger • 6-stage torque setting • 2-speed  
gear selection, low (0-400 RPM) or high (0-1,100  
RPM) keyless chuck system • drills 1/2" in steel  
and 3/4" in wood • lot includes two batteries,  
charger and rugged plastic tool case



**\$ 61.99**  
Model N9514BK  
• high power-to-weight ratio: 5 AMP • compact  
and extremely lightweight (3.3 lbs.) • 11,000 RPM  
• conveniently located thumb switch • overload  
protector helps prevent motor burnout • wide  
assortment of optional accessories available  
• double insulated • includes plastic tool case

**NEW HUDSON LUMBER & HARDWARE CENTER**



56601 Grand River • New Hudson  
Hours: Mon. - Fri. 7-7; Sat. 8-6; Sun. 9-5  
**(810) 437-1423**

"Your Quality Source for  
Timber and Tools"

**ERWIN'S  
COUNTRY  
STORE**

61019 Silver Lake Rd.  
South Lyon

**(810) 437-4704**

Store Hours: Monday - Saturday 8-6; Sunday 10-5

Large  
Selection  
of Gift  
Baskets

**IMPORTANT INFO.**

- Last day to order Hams & Baked Goods is December 18th
- Closed for the season at 3:00 pm December 24th

**Gift items featuring:**

- Yankee Candles • Goodwin Weaver Throws
- Lang Calendars • Ty Plush Animals
- Camille Beckman skin care plus much more

coupon  
**20% Off**  
All Baked Goods  
with this coupon  
Coupon good thru  
December 18th  
while supplies last

coupon  
**25% Off**  
Any Regular  
Priced Gift Item  
with this coupon  
Expires 12-24-96

## Crystal Slipper Nail Salon



Come in for your holiday nails

200 McHattie • South Lyon  
(810) 486-6649

Bring the whole gang to shop for all your holiday buys in  
**South Lyon!**



## Pat's FIELD of FLOWERS

22331 Pontiac Trail - South Lyon  
just S. of 9 Mile in Brookdale Square  
(810) **437-7997**



Add elegance and charm to the holiday.  
The Frosty Cookie Jar Bouquet  
Starting at

**\$27.50**

Teleflora

Be sure to stop in and see our  
**Holiday Specials!**

(810) 486-5838

**PET STOP**

FOOD & SUPPLIES

Located in Brookdale Square  
22351 Pontiac Trail  
just south of 9 Mile

# 1ST

Evening and Saturday Hours

## OPTOMETRY

eye care centers

(810) **437-7600**

**DR. PHILIP KONTRY, Optometrist**

22321 Pontiac Trail • South Lyon • In Brookdale Square  
Welcome To South Lyon. Please Stop In For Your

**FREE Home Eyeglass Repair & Adjustment Kit**

Bring this coupon into the First Optometry location nearest you and receive a handy eyeglass repair kit. Containing a specially designed screwdriver, magnifying glass and replacement screws for your glasses. ... And it's ABSOLUTELY FREE! Supplies are limited, so hurry in! No purchase necessary. One per person.

# SAVE \$20

**On Glasses or Prescription Sunglasses**

This coupon is good for \$20 off your choice of glasses (lenses & frame) or prescription sunglasses (lenses & frame). Prior orders and other discount programs excluded. One coupon per patient, per purchase. Limited time offer. Not valid with \$79 package or other sale programs.

Expires 12-31-96

Visit **SANTA**  
Sat. December 7th at

## South Lyon RESALE Shoppe

120 E. Lake St South Lyon **810-437-5055**

- Photo with Santa • Candy Canes • Balloons
- Drawing Every Hour • Refreshments

## North Carolina Nursery and Craft

Come and experience a *Country Christmas* at North Carolina Nursery and Craft.

Fresh Cut Pine, Spruce & Douglas Fir. Also Fraser Fir, Wreaths, Roping - direct from the mountains of North Carolina.

Visit Our Country Store for All of Your Christmas and Country Collectibles.

- Rocking Chairs • Pictures • Baskets • Stencils by Jean Smith • Country Furniture • Potpourri • Candles
- Dried Flowers • Savannah Cinnamon Mix • Garden Gifts
- Bird Houses • Gift Baskets and much much more.

Also visit us at our downtown location next to Diane's Doll House during the weekend of the Christmas Walk.

*Happy Holidays From Us to You!*

**810-486-3735**



557 S. Lafayette • South Lyon



Located on Pontiac Trail between 9 and 10 Mile in the South Lyon Center.

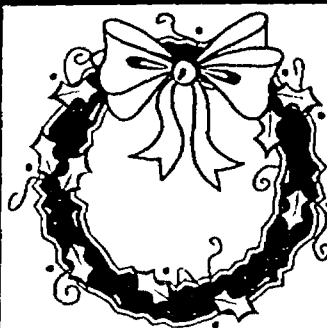

*Holiday savings are now in style.*



**FS**  
HAIR CARE

**CUT PLUS**

- Shampoo • Conditioning Rinse
- Precision Cut • Style

# \$11.95

Reg. price \$14.00

## Fantastic Sams

576 N. Lafayette • South Lyon

**(810) 486-1661**

Hours: Mon. - Fri. 9:00am-8:00pm; Sat. 9:00am-5:00pm

Bring your gift list to  
**KACEE'S Hallmark Gold Crown!**



1997 DAY-BY-DAY CALENDAR



MOJO  
 GREETING CARDS  
 Holiday Wishes  
 1996

**BUY ONE CALENDAR  
 GET THE 2ND ONE  
 1/2 OFF**

*Of equal or lesser value.  
 One per customer • With Coupon  
 Expires 12-24-96  
 Not valid with any other offer and previous purchases.*

**BUY \$20.00 worth of  
 holiday ornaments  
 and receive  
 a FREE  
 Greeting Card**

*Up to a \$2.50 value.  
 One per customer • With Coupon  
 Expires 12-24-96  
 Not valid with any other offer and previous purchases.*

**KACEE'S** *Hallmark*

**LIVONIA**  
 6 Mile & Farmington  
 (313) 427-2505

**W. BLOOMFIELD**  
 6645 Orchard Lake  
 (810) 851-8685

**NORTHVILLE**  
 119 N. Center St.  
 (810) 348-0290

**NOVI**  
 43151 Crescent Blvd.  
 (810) 344-4588

**WHITE LAKE**  
 10871 Highland Rd.  
 (810) 698-3250

Also Locations in Sterling Heights & Chesterfield



**Holiday shopping shouldn't  
 make you want to SCREAM!**

Visit Art Source for personalized service on  
 affordable art, framed & unframed ... prints &  
 museum reproductions ... original photography  
 ... custom mirrors ... art lover's note cards ...  
 gift certificates ... the finest in custom framing

**ART • SOURCE**

AFFORDABLE ART • PICTURE FRAMING SPECIALISTS

126 Main Centre Building  
 (Center Street, south of Main)  
 Downtown Northville  
**(810) 348-1213**

HOLIDAY HOURS (beginning November 22)  
 Monday thru Friday 10:00-8:00 Saturdays 10:00-6:00 Sundays Noon-4:00

*Milford's General  
 Store*







**"We've Got Gifts for Everyone!"**  
*\*Featuring Christmas Creations by Beverley Paisley of "Out Of the Woods"\**

🎄 Leather Wallets 🎄 Money Clips 🎄 Watches  
 Pen/Pencil Sets 🎄 Cotton Throws 🎄 Coffee Beans  
 🎄 Hand Made Chocolates and much more!

**GIFT BASKETS**  
 Come see our Holiday Gift Baskets  
 in various sizes filled with coffees,  
 candies and various Gift items-Great Selection

Visit our walk-in  
**HUMIDOR ROOM**  
 Featuring a large selection of  
 premium cigars and accessories

**423 N. Main St., Milford**  
 on the porch with Milford Travel, Peony House  
 and After Image Salon  
**(810) 684-7388**



**2 DAYS  
 ONLY!**  
*Nov. 29 and 30*

Sensational Thanksgiving Week-end Savings on  
 Janome-New Home Sewing Machines & Sergers!

**MODEL 108**  
 Economy plus high performance in great  
 multi-stitch machine. Special low price makes  
 it a terrific value.

**NOW ONLY \$199!**

*Memory Craft 3000*  
 Enjoy the ease and beauty of modern computer  
 sewing at this rock-bottom holiday price!

**ONLY \$799!**

**DAY AFTER THANKSGIVING SALE!**

DON'T  
 MISS  
 IT!

SUPER SALE 6am-6pm  
 20% OFF  
 All Notions & Fabrics

Early Bird Specials from 6am-noon  
 Livingston County's largest quilt shoppe with over 2,500 100% cotton bolts of  
 fabric and new to the shoppe - a full line of unbelievable wools!

NOV. 29th  
 ONLY!

*The Stitchery*  
 1129 E. Grand River  
 (517) 548-1731



**WILD BIRD MARKETPLACE**  
 205 W. Main  
 Downtown Brighton  
 229-7303

**GIFT IDEAS FOR NATURE LOVERS!**

M-F 10-8  
 Sat 10-6  
 Sun 12-5

**Kid's Workshop**  
 Sunday, Dec. 8  
 1-3 p.m.  
 Make & take ornament for the birds

Squirrel-Proof Feeders  
 Bird Books  
 Garden Statuary  
 Nature Music & Videos  
 Purple Martin Apartment  
 Bat House  
 Nature Figurines  
 Flags  
 Window Feeder  
 Wind & Solar Ornaments  
 Bluebird House  
 Sweatshirts  
 Thistle Feeder  
 Hummingbird Feeder  
 Swift Binoculars  
 Hatched Bird Bath

**Looking for the perfect CHRISTMAS GIFT?**

Put your home MOVIES, SLIDES, or PHOTOS on to video cassette for easy TV viewing. Video Transfer makes the perfect gift for the whole family. Extra copies are only 10 bucks, so why not give the gift of memories to all your family and friends?

**\$5.00 OFF** Your Movies, Prints or Slides Transferred to Video Cassette

Or \$3.00 off Video Duplication • One Coupon Per Person • Expires 1-15-97

**American Video Transfer, Inc.**  
 810 E. Grand River  
 Brighton  
 (810) 227-5001

**CITY OF BRIGHTON**

**HOURS:**  
 Mon.-Fri. 9-6  
 Sat. 9-1

KROGERS  
 ST. PATS  
 E. GRAND RIVER

Presenting  
 the U.S. Savings Bonds  
 that money alone  
 can't buy.

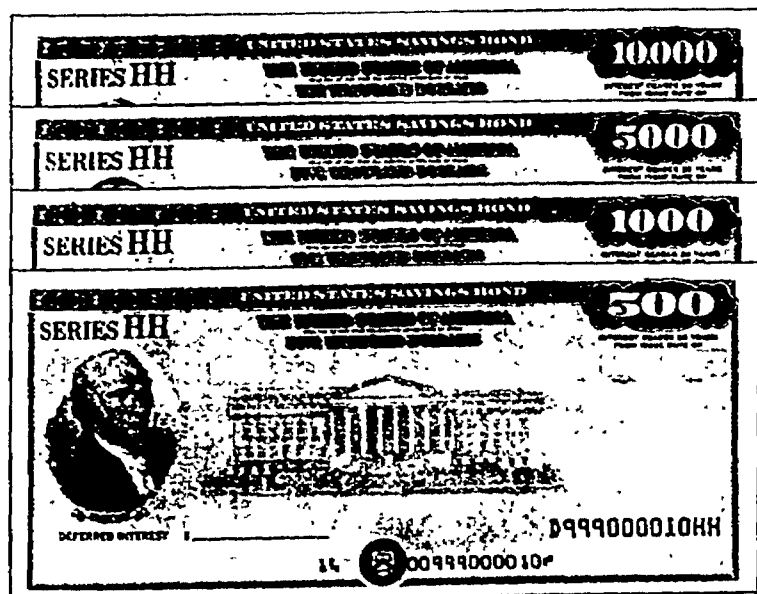

There's only one way to get Series HH Savings Bonds: Exchange Series E/EE Savings Bonds and Savings Notes for them.

HH Savings Bonds, of course, offer the security of knowing your investment is backed by the full faith and credit of the United States. They also offer tax advantages.

With HH Bonds, you'll receive interest payments every six months for up to 20 years. That interest is exempt from state and local income taxes, although it's subject to annual federal income tax reporting. If, however, you've deferred reporting the interest earned on your E/EE Bonds, you may continue to do so for up to 20 more years or until you redeem the HH Bond, whichever comes first. Or you can report the accumulated interest when you exchange your E/EE Bonds for HH Bonds.

Ask about the Bonds money alone can't buy, Series HH Bonds, where you bank, or write: U.S. Savings Bonds, Washington, DC 20226.

For a recorded message of current rate information, call  
 1-800-4US BOND • 1-800-487-2663

Certain restrictions apply. Ask for details.



A public service of this newspaper

**ONE-STOP CHRISTMAS SHOPPING**

at  
*The Village Collection*

**Village Mercantile**  
Old Country Store  
Gifts & Food

**The Potting Shed**  
Garden Accessories  
for both indoors & out

**Aunt Ellie's Emporium**  
Potpourri scented candles & much more

**Santa's Corner**  
Handcrafted Christmas decorations everything from ornaments, stockings, trees

**Grandma's Tea Garden**  
Herbal Teas, Cappuccino, Cocoa & other delights

Bring in for **FREE DRAWING** 10 prizes

*The Village Collection*  
360-1951  
7718 Cooley Lake Rd.  
(located in Lake Plaza)

Bring in for **FREE Coupon Book**

Select A Diamond And Color Stone Slider In Any Design Available with an Omega Chain To Make The Perfect Holiday Gift!

- Gold Chains and Charms
- Diamonds at True Discount Prices
- Watch Batteries Installed While You Wait
- Loose Color Stones
- Repairs Done on Premises by Expert Jewelers
- Pearl Restringing, Gem Identification Service

Men's or Ladies  
**BULOVA WATCHES 25% OFF**  
(in stock)

Over 25 Years of Jewelry Experience - Whatever your price range, we have it! From affordable to high fashion.

**Royalty Jewelers, Inc.**

Mon.-Fri. 11-7 41714 W. 10 Mile • Novi (810) 347-7773  
Sat. 11-5 (Farmer Jack Center)

Our program has Helped children for so long, We remember making these with macaroni Instead of pasta.

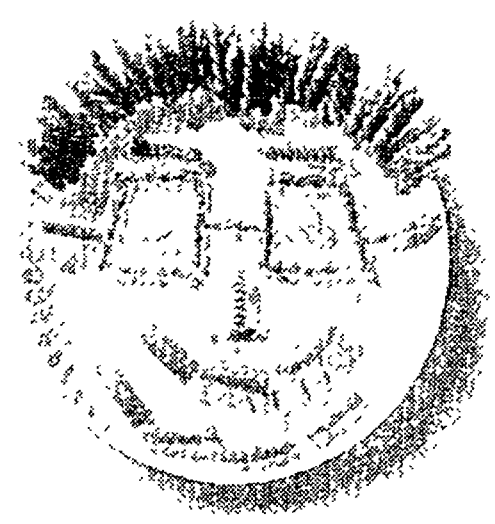

Since 1965, we've worked to make sure all children have the opportunity to learn valuable lessons during the years when it's easiest for them to learn. To find out how you can help, call your local Head Start.



Nurture the future  
BE A HEAD START VOLUNTEER





**NORTH POLE**

SPECIALS FROM

# Santa's Workshop

Visit our bigger store for a Christmas extravaganza. We have loads of Christmas decorations and gift ideas for everyone on your list!

**ACE SUPER**

9803131



**79¢ Roll**  
Wrapping Paper  
30 sq. ft. in assorted patterns.

**COUPON**

Good at participating Ace stores. Limit 6 Expires 12/31/96



Full profile tree with up-swept branches. Perfect for any room in the house. 9812926

6 1/2' Austrian Fir

**\$49.99**

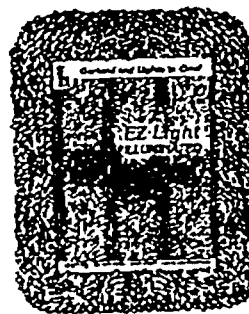

Pine garland features 70 decorator light set. Clear or multicolors. 9814401,19

36' Lighted Garland

**\$14.88**



You pay 8.99  
Main-in rebate -4.00  
Final cost 4.99

**100 Light Mini Set**

Assorted or clear bulbs. End-to-end strand for indoor/outdoor use. UL listed. 96303,04

**\$8.99**



**ACE Manager's Special**

**100 Watt Floodlights**

Ideal for decorative holiday lighting as well as security. Assorted colors. 30976,77,78,31413

**\$2.99**



**ACE Manager's Special**

**Spotlight Kit**

Light lawn, patio or driveway with a weatherproof spotlight. Stake into ground or mount on wall. 6' cord. (Floodlight not included.) 31672

**\$2.99**



**Colorbright Outdoor Light Set**

25' String of long-life, multi-colored ceramic C9 bulbs. Six-way decorating clips on sockets. 9814039

**ACE Manager's Special \$7.47**

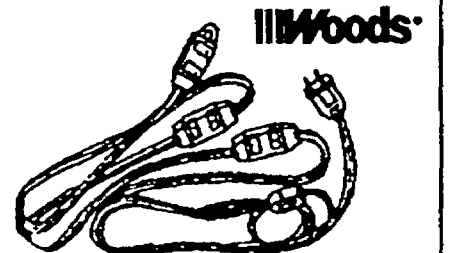

**Woods**

**Christmas Tree Extension Cord**

Put 9 outlets in your tree. 15' cord with on/off switch. Excellent for Ceramic villages and other decorations. Green or white. 3060522,5114

**\$3.77**

**Fed Ex drop box available for your holiday shipping!**

## South Lyon Lumber

**(810) 437-1751**

**ACE HARDWARE**

415 E. Lake St  
South Lyon



# Decorate home to evoke yuletide spirit

By Lee Littlewood  
Copley News Service

"Oh! holly branch and mistletoe,  
And Christmas chimes where'er we go,  
And stockings pinned up in a row!

These are thy gifts, December!"

Harriet F. Blodgett captured the spirit of holiday home decor when she penned these festive words long ago. They still ring true in many homes today, and for many families who forget their differences and join together to celebrate winter spirits and joyous home affections.

You don't have to be a pro-

fessional decorator to make your house an inviting seasonal haven. All you need is enthusiasm. For some, opening boxes of treasured ornaments and decorations is as exciting as opening gifts. Others thrill at the first sight of twinkling lights glistening from dressed-up trees.

Most of us are reminded during the holiday season that goodness, magic and togetherness still exist. So how do you manage, between shopping, cleaning, paying bills and working, to turn your home into a festive oasis that captures these good tidings?

Check out decorating books at the library or bookstore. Full of ideas for even the not-

so-creative, many are available for your perusal (and you won't be charged to copy ideas). One in particular that's as charming as the projects inside is "Mary Englebreit's Christmas Companion" (Andrews and McMeel). Englebreit, one of America's premier illustrators, greeting card creators and decorating experts, offers her whimsical, fun-to-look-at home scenes and Christmas craft ideas.

Besides the homey, colorful room scenes, the book, subtitled "The Mary Englebreit Look and How to Get It," includes "Breit Ideas," such as



Flickering, fragrant votive candles are a quick and easy way to create a warm holiday ambience.

Continued on 54

"Your Gift Department Store with Hallmark Cards"

  
**Hallmark**

Register to Win  
**A Patchwork Quilt**

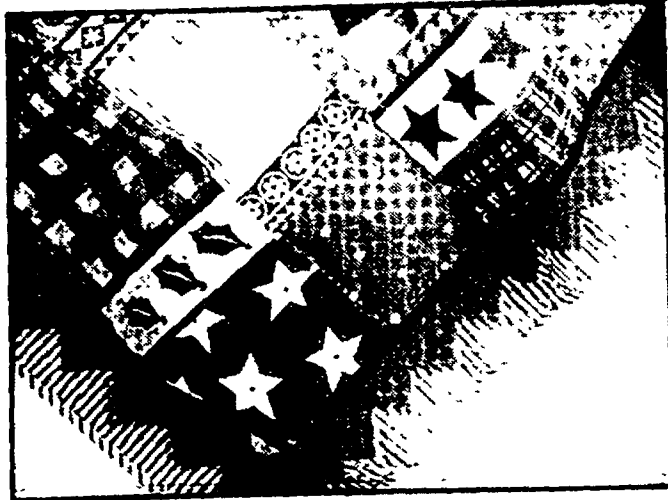

A unique holiday tradition could be yours!  
Enter By December 14, 1996  
Drawing Monday, December 16  
No purchase necessary





*Bon Ton Shoppe*

**FARMINGTON**  
DOWNTOWN FARMINGTON  
Grand River at Farmington  
M-F 9-9, Sat 9-6

**BRIGHTON**  
BRIGHTON MALL  
Grand River at I-96  
M-F 9-9 Sat. 9-6

**LIVONIA**  
NEWBURGH PLAZA  
6 Mile at Newburgh  
M-F 9-9, Sat. 9-6

**MILFORD**  
PROSPECT HILL (Kroger)  
Shopping Center  
Milford Rd Near Summit St  
M-F 9-9, Sat. 9-6

**A. KEAN PICTURE FRAMING**

**GOURMET FRAMERS**  
Best Framers in the Industry  
Family Owned -  
Knowledgeable and Extremely  
Clever in Design!!

**WE INVENTED THE  
50% OFF  
POSTER AND PICTURE FRAMING!**

**41787 GRAND RIVER, NOVI, MI 48375**  
1/4 mile west of Meadowbrook Rd. on  
the south side of Grand River  
**(810)347-0991**  
M-T-W-F 10-6, Th 10-7, Sat. 9:30-4, Closed Sun.

*Merry Christmas*

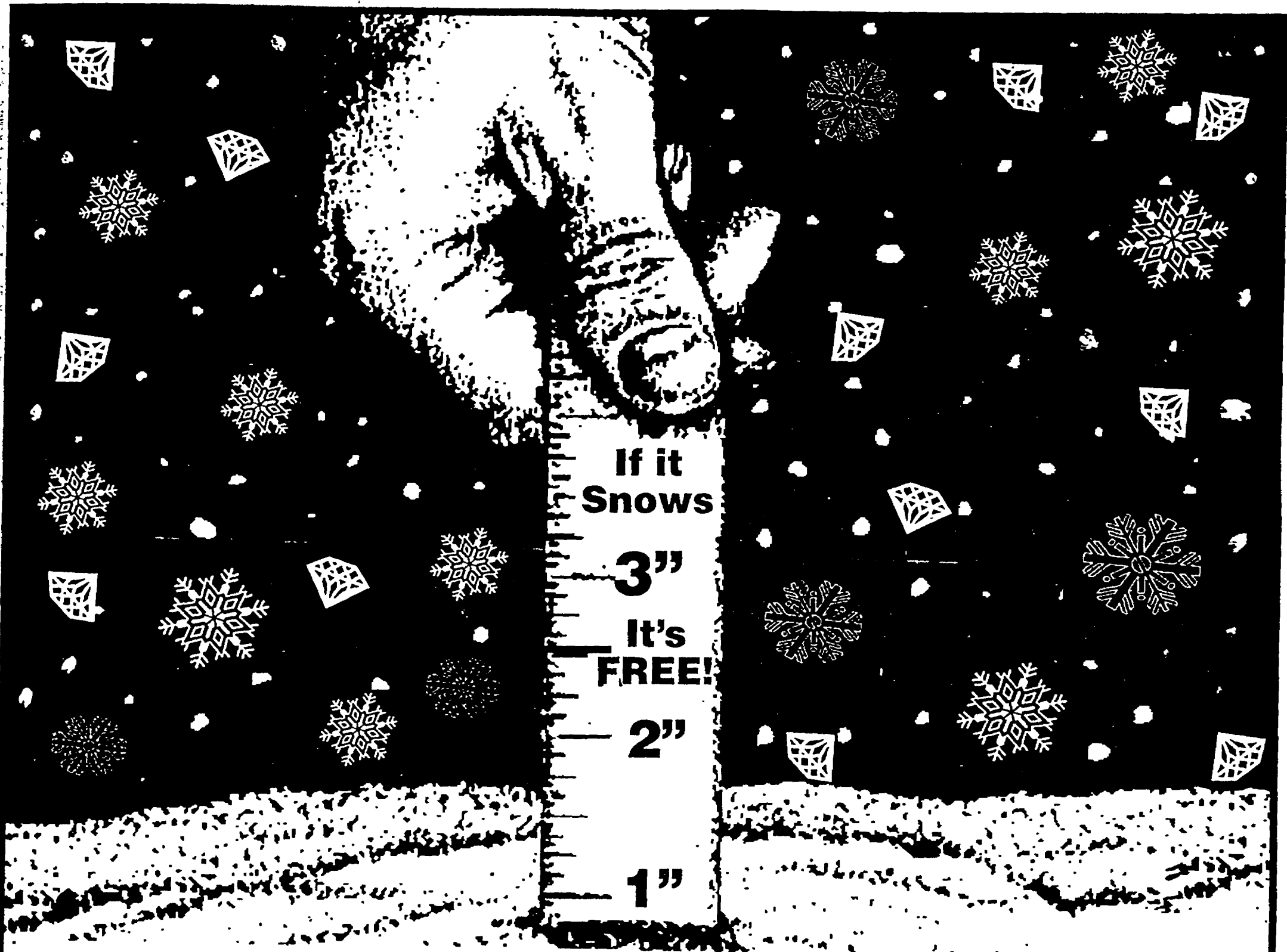

# Ho..Ho..Ho..I Hope It Snows!!

Would You Like To Get All The Jewelry You Purchase  
This Holiday Season

## FREE?

If it snows 3" or more on New Year's Day, Jan. 1st, 1997, you will be refunded 100% of each purchase  
you made between November 15th & December 15th, and you still keep the jewelry

**Keep Your Receipt & Pray For Snow!**

Insured by World Wide Weather  
MASTER  JEWELERS

## F.A.O. JEWELERS

320 W. Grand River Ave.  
**BRIGHTON**  
(Across from Dairy Queen)

Diamond  
Specialists



Custom  
Designs

NO PURCHASE NECESSARY • SEE STORE FOR DETAILS

(800)  
**887-GEMS**

<b>CHRISTMAS LOANS AS LOW AS</b>	<b>7.50%</b>
<b>NEW AUTO LOANS AS LOW AS</b>	<b>7.50%</b>
<small>(Refinance of Dealer Loans on New Autos Welcome)</small>	
<b>USED AUTO LOANS AS LOW AS</b>	<b>8.50%</b>
<b>AUTO LEASING AS LOW AS</b>	<b>7.50%</b>
<small>(Loan Rates Are Subject to Change Without Notice)</small>	
<b>SAVINGS AND CHECKING ACCOUNTS</b>	
<b>AAA GROUP INSURANCE FOR HOME AND AUTO</b>	
<small>(Could Save as Much as 25% on Your Auto and 10% on Your Home Premiums)</small>	
<b>HOME EQUITY AND MORTGAGE LOANS</b>	
<b>VISA AND LINE OF CREDIT - LOW RATES</b>	
<small>CALL OR COME IN TO GET MORE INFORMATION</small>	

**SUBURBAN CATHOLIC CREDIT UNION**  
 31716 GRAND RIVER FARMINGTON, MI (810) 474-7100  
 546 N. PONTIAC TRAIL WALLED LAKE, MI (810) 624-3662

MEMBERS OF THE CREDIT UNION FAMILY SERVICE CENTERS AND ATM SC24  
 18 LOCATIONS IN MICHIGAN

EACH MEMBER INSURED TO \$100,000

**NCUA**  
 NATIONAL CREDIT UNION ADMINISTRATION  
 U.S. GOVERNMENT AGENCY

**MUST QUALIFY FOR MEMBERSHIP TO OPEN ACCOUNT AT SUBURBAN CATHOLIC CREDIT UNION**



STUFF THE STOCKINGS WITH GIFT CERTIFICATES FROM

## Oxford Inn Tavern

Oysters • Seafood • Steaks

Casual Dining  
 Featuring Live Blues  
 Thurs. • Fri. • Sat. 810-305-5856

VOTED "BEST RIBS"  
 Detroit Monthly 1996

43317 East Grand River (at Novi Road) Novi  
 Open: 11:00 a.m. Mon.- Fri., 4 p.m. Sat. & Sun.

## Michigan Made Inc.

Home of Michigan Made Products



GWEN FROSTIC • PEWABIC POTTERY  
 BULLFROG CANDLES

&

Lots of Michigan Foods  
 Books & Lighthouses

830 W. ANN ARBOR TRAIL • DOWNTOWN PLYMOUTH  
 (313)207-8494

## RENT-A-FLICK

47230 W. 10 Mile Novi, MI 48374  
 810-349-2000

HUGE STOCK OF NEW RELEASES

VCR SERVICE FREE ESTIMATES

10% OFF ANY PURCHASE Exp. 1-10-97	PLAYSTATION & NINTENDO 64 RENTAL	RENT 2 MOVIES FOR THE PRICE OF 1 Exp. 1-10-97
--------------------------------------	----------------------------------	--

## "SOFT TOUCH" CHIROPRACTIC

23895 Novi Road, Novi

Dr. Kathy Duncan, R.N., D.C. is a former registered critical care nurse who changed career paths after learning about the benefits of chiropractic care through a personal success story.

Dr. Duncan suffered from severe migraine headaches, which physicians attributed to stress. As a last resort, she sought chiropractic treatment. The chiropractor informed her of a misalignment in her neck, corrected the source of her pain, and eliminated her migraine headaches. She's been a believer in chiropractic ever since.

Dr. Duncan so strongly supported the achievements of chiropractic, she decided to pursue a degree as a Doctor of Chiropractic and attended Life Chiropractic College in 1983. Three years later, she graduated from the college and was president of her class. Dr. Duncan established the successful Soft Touch Chiropractic Clinic in Novi during 1990.

Dr. Duncan practices a soft, gentle, non-invasive pressure point treatment for all types of pain or discomfort in the back, neck, head or legs. With the spine as the focal point, muscles are relaxed by using pressure on the points along the muscles in conjunction with the spine. Once the muscles are relaxed, the spine readjusts itself naturally.

Tight muscles caused by stress, tension, strains or trauma can pull the spinal column out of alignment. This can produce many types of pain or discomfort in the body. "There are no chemicals or drugs masking any symptoms," she said. "We treat the



*Dr. Kathy Duncan*

cause, rather than the symptom."

Dr. Duncan and her friendly support staff, Marty Schwiekhart, Deb Bradshaw and Barbara Murdock make patients feel welcome. "We really try to go out of our way to make them feel comfortable," she said.

Soft Touch Chiropractic is open four days a week and offers Saturday hours by appointment only. Dr. Duncan can be reached at (810) 348-2000.



## CARPET TWO ROOMS GET ONE ... FREE!

What A Great Gift for the Holidays!  
 We Will Come Directly to Your Home and let you select your carpet colors from our top quality brands (or come to our showroom)!

You'll Never Beat Our Prices  
 And Our Sale Never Ends!

ESTIMATES • SALES • INSTALLATION  
 Philadelphia • Salem • Cabin Craft • Sutton • Aladdin • World • Mohawk  
**BERBER SPECIALISTS**  
 Directly From The Mill To You  
 Anso Crush Resister, DuPont Stainmaster, Scotchguard Xtralife

IF YOU HURRY - WE CAN HAVE YOUR CARPET INSTALLED BEFORE SANTA COMES DOWN THE CHIMNEY!

FILTER QUEEN AND SHARP VACUUMS SOLD AT LOW LOW PRICES!

RECEIVE A \$50 MOUNTAIN JACK GIFT CERTIFICATE WITH PURCHASE OF 40 YARDS OR MORE

CARPET • LINOLEUM • HARDWOOD FLOORS

Serving The Tri-County Area In Floor Care Since 1974

## J&R Industries

27488 Schoolcraft • Livonia  
 (313) 525-5211

\*FREE ROOM consists of specialty carpet and pad...also labor up to 16 yards.

# Visit Novi Town Center & Rekindle the Glow this Holiday Season

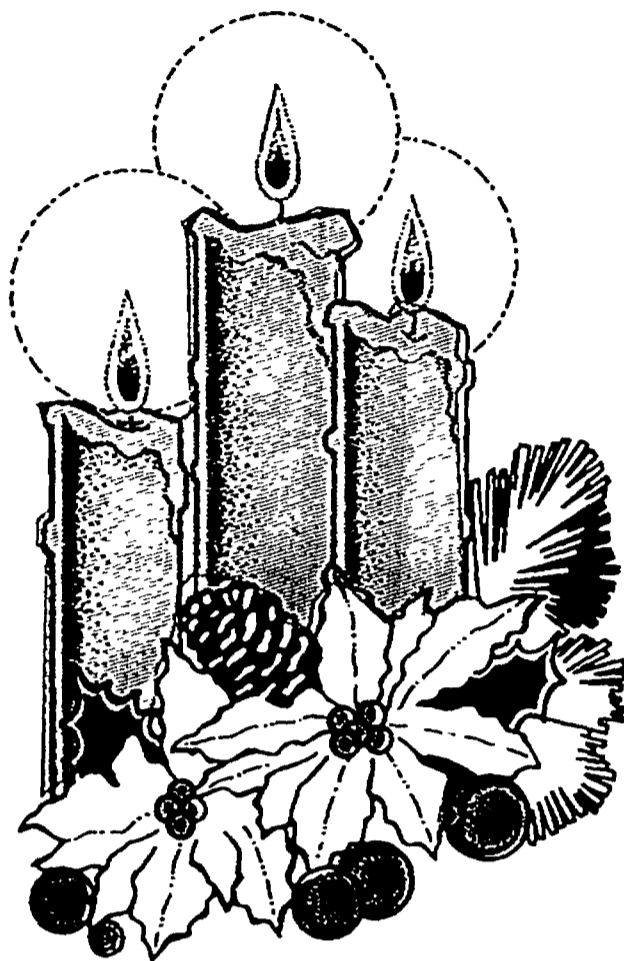

## IMPORTANT PROMOTION RULES

To redeem your Mrs. Baker's Original Recipe® Scented Apothecary Candle Jar you must:

1. Make your purchases from at least two Novi Town Center merchants between November 20 and December 24.
2. Spend a minimum of \$150.00.
3. Have your receipts stamped at the time of redemption.
4. Limit is one candle per customer.
5. Candles may not be exchanged for other items or returned for cash.
6. Offer good only while supplies last.

## REDEMPTION CENTERS:

TJ Maxx  
Town Center Gallery  
White Rabbit Toys  
Kitchen Glamor

Charisma Salon  
Borders Books & Music  
Kacee's Hallmark



**NOVI TOWN CENTER**

On Eleven Mile Between I 96 and Grand River

# SNOW THROWER SALE!



**4 Cyl. NO GAS/OIL MIXING**

**HONDA**  
Power  
Equipment

- 5.5 hp easy-start Honda 4-cycle OHV engine
- 21" clearing width
- Discharges snow up to 33 feet!
- Electric start also available

†Max. depending on snow conditions

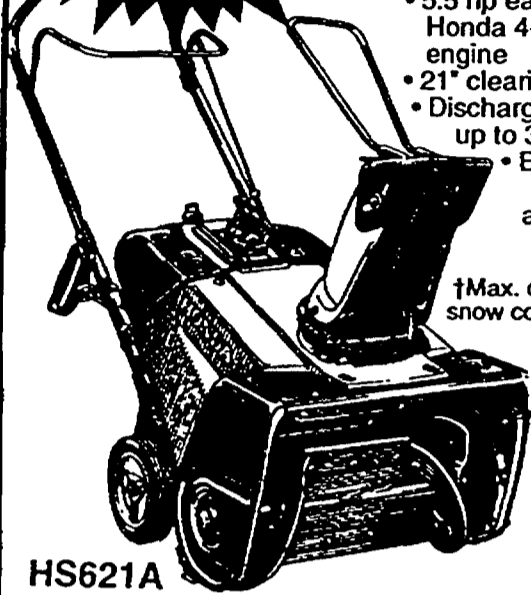

HS621A

For optimum performance and safety, please read the owner's manual before operating your Honda Power Equipment.  
©1995 American Honda Motor Co., Inc.

**SNAPPER.**  
"LEGENDARY QUALITY"

Reg. \$529<sup>99</sup>  
Now \$469<sup>99</sup>



- 3 hp
- 19" clearing width
- 2 year warranty

Now \$449<sup>95</sup>

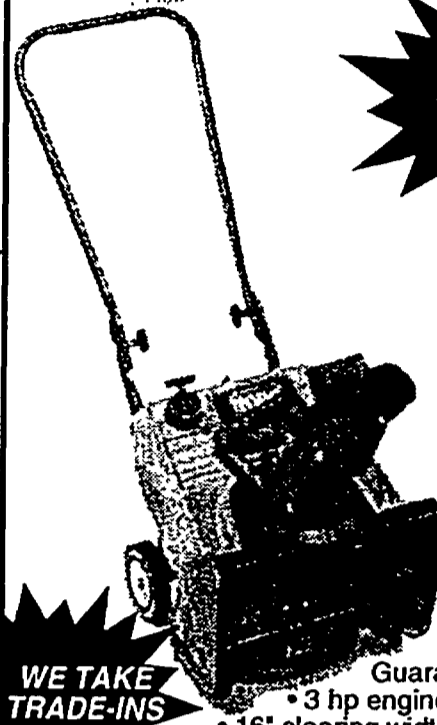

**EXCLUSIVE POWER CURVE® TORO® CCR POWERLITE® SNOWTHROWER**

• Exclusive Power Curve® snowthrower Money-Back Performance Guarantee\*

- 3 hp engine
- 16" clearing width
- Throws snow up to 25 feet (while supplies last)

**TORO**

**WE TAKE TRADE-INS**

**When you want it done right.**



**Cougar Cutting Products & Supply, Inc.**

(810) 348-8864  
46845 12 Mile Rd.



(© Beck Rd. & I-96)

**We Take Trade-Ins**

Hours:  
M 7:30 a.m. - 6:00 p.m.  
T-Fr. 7:30 a.m. - 5:30 p.m.  
Sat. 9:00 a.m. - 3:00 p.m.

We're Having a Sale!!

## ROLISON PRO HARDWARE \$\$ Makita Savings! \$\$

111 W. Main  
Downtown Brighton  
(810) 229-8411

### New For 1997

#### CORDLESS DRILL

6263 DWAE  
9.6 Volt  
Reg. \$189<sup>99</sup>

Now \$165

6213 DWAE  
12 Volt  
Reg. \$219<sup>99</sup>

Now \$189<sup>99</sup>



6233 DWAE  
14.4 Volt  
Reg. \$249<sup>99</sup>

Now \$210<sup>00</sup>

- 2 Speed Gear
- 17 Torque Settings
- External Access Brushes
- Push Button Forward/Reverse Switch
- Keyless Chuck

**Makita**  
"CALL FOR POWER TOOLS"

COMPOUND MITER SAW  
LS1040  
Reg. \$286<sup>99</sup>

Now \$245

RECIPRO SAW  
JR3020  
Reg. \$189<sup>99</sup>

Now \$164

DISC GRINDER  
N9514BK  
Reg. \$69<sup>99</sup>

Now \$58

HEDGE TRIMMER  
UH303DST  
Reg. \$169<sup>99</sup>

Now \$48<sup>00</sup>

With Free Battery!

GRASS TRIMMER  
UM140DST  
Reg. \$149<sup>99</sup>

Now \$48<sup>00</sup>

With Free Battery!

STRING TRIMMER  
RBC 251  
Reg. \$289<sup>99</sup>

Now \$210<sup>00</sup>

CORDLESS DRILL  
6095DWEL-2  
Reg. \$145<sup>99</sup>

Now \$127<sup>00</sup>

3/8" DRILL  
6406  
Reg. \$64<sup>99</sup>

Now \$57<sup>00</sup>

7/8" CIRCULAR SAW  
500 7NBAK  
Reg. \$129<sup>99</sup>

Now \$115<sup>00</sup>

10" MITER SAW  
LS1030  
Reg. \$219<sup>99</sup>

Now \$189<sup>00</sup>

COMPOUND SAW  
LS1211  
Reg. \$889<sup>99</sup>

Now \$750<sup>00</sup>

RANDOM ORBIT SANDER  
B05001  
Reg. \$69<sup>99</sup>

Now \$58<sup>00</sup>

CASUAL OUTDOOR FURNITURE AT  
COMPLETELY RELAXED PRICES

*Jimnies*   
RUSTICS

## FULL TREES—HALF PRICE

WE'VE BROUGHT THE FOREST AND SKY INDOORS FOR YOU TO ENJOY

Jimnies invites you to come  
see our holiday collection of  
fabulous "faux" firs (trees, that is).

Our Christmas trees are full,  
round, and incredibly life-like.

Adorn them with sets of our  
unique and magical lights fea-  
turing colors stolen from the  
skies — soothing teal blues,  
frosted silver-whites,  
even rich burgundies.

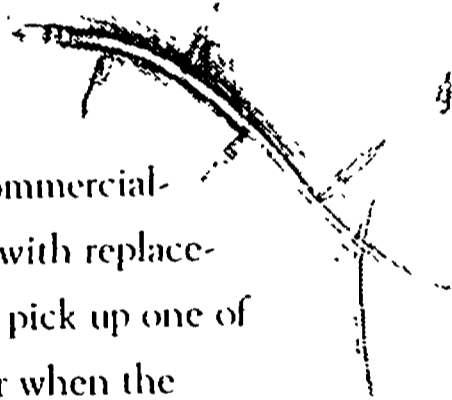
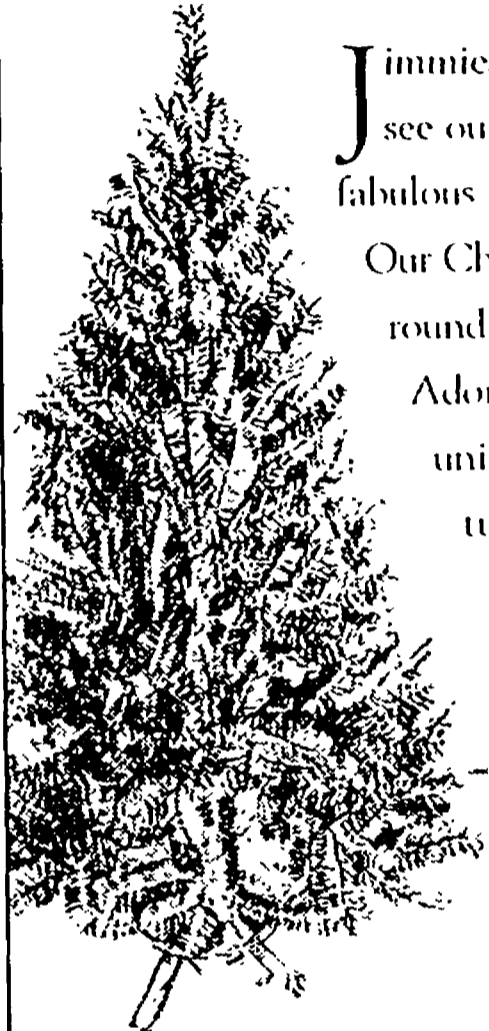

These extremely durable, commercial-  
grade lights come complete with replace-  
ment bulbs and fuses. And pick up one of  
our handmade toboggans for when the  
winter beckons you outdoors! Bring

winter's outdoor charm into your home  
with holiday furnishings from

Jimnies.

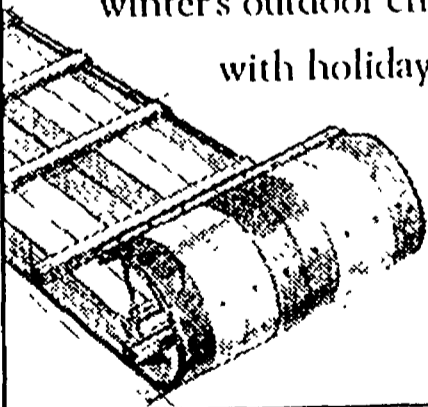

**30 TO 50% OFF**  
7 FOOT TREES FROM \$69

PLEASE CALL FOR STORE HOURS

BIRMINGHAM 810-644-1919  
690 S. WOODWARD

LIVONIA 313-522-9200  
29500 W. 6 MILE RD.

NOVI 810-348-0090 • 48700 GRAND RIVER

*Jimnies*   
RUSTICS

*Happy  
Holidays*

...and to make  
your Holidays  
bright, we have  
a huge selection of special gifts for  
you, your family, friends and clients!

### Specialty Fruit & Gift Baskets

from \$25 to \$150

Filled with an assortment  
of extra fancy fruit, nuts,  
assorted cheeses, candy,  
and much, much more!

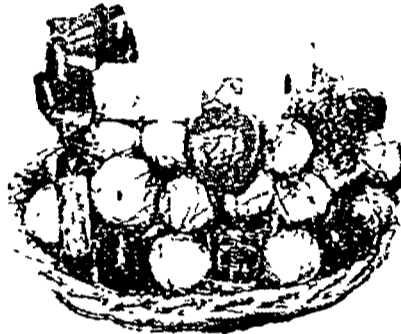
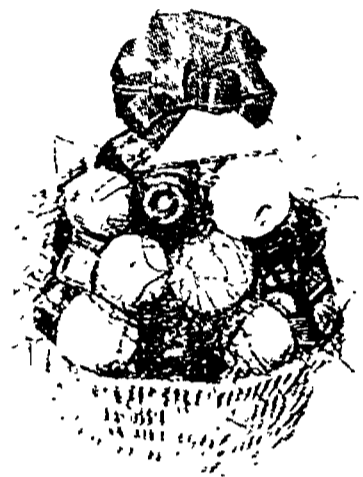

For Fruit and  
Gift Baskets  
call  
(810)477-4333

### Large Selection of Quality Poinsettias & Arrangements

Fresh & Silk  
Holiday  
Arrangements



And gifts for  
your home or  
business

**DON'T BE DISAPPOINTED...ORDER EARLY!**

*Flower's From Joe's*

and

BY CAROLYNN



*Joe's Produce*



33018 West Seven Mile • Livonia  
DELIVERY AVAILABLE TWICE DAILY THROUGHOUT METRO DETROIT

Corporate Accounts Welcome!

Mon.-Fri. 9-6  
Sat. 9-5

**(810) 477-8616**



1-800-956-JOES

Fax (810) 477-0176

## THE PERFECT HOLIDAY GIFT!

We have it for . . .  
Co-worker . . . Friend . . . Family  
and/or Loved One

All Occasion "Theme" Gift Baskets

Call for Gift Certificates, information and/or appointment.  
MC-Visa Welcome -- We deliver UPS Daily

Your Full Service Hair, Nail & Body Spa  
"Home of the Makeover Specialists!"

Gift Certificates

*Polished Outlook* inc.

"Spa in the Village"  
325 W. Main St., Milford  
(810) 685-9898

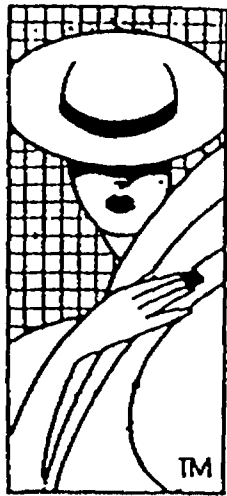

## KIRKLAND FARMS

Your Local Landscape Center  
21130 Pontiac Trail • South Lyon MI 48133  
(810) 486-5400

## Fresh Cut Christmas Trees

Lighted Yard

Open 7 Days

- Fresh Wreaths & Roping  
Wreaths custom made with our decorations or yours
- Novelty Wreaths & Swags
- Grave Blankets • Gifts



**\$200 Off**  
your purchase  
with this ad



## S-J's TRACK SHACK Green Cash Sale

on Western Fashions  
**30% OFF**  
everything in stock\*  
now thru CHRISTMAS

Open 7 days, now thru Dec. 24th.

514 S. Grand, Fowlerville  
(517) 223-7442

excludes Wrangler Jeans & Minnetonka Moccasins



Home to over  
25 dealers.  
Offering a wide  
variety  
of primitives,  
intricate glass,  
lamps,  
furniture &  
more!  
Consignments  
Welcome



YEAR ROUND HOURS:  
Tuesday-Saturday  
10 am-5 pm  
Sunday 12 Noon-5 pm  
Closed Mondays

Other closings: All legal holidays, Christmas Eve & Day,  
New Years Eve & Day and Easter Sunday

(810) 349-0117

48120 W. Eight Mile Road, Northville  
1/4 Mile West of Beck Road

Announcing  
Christmas in the  
Barn, featuring "The  
Christmas Village."  
Come join us for the  
holidays with  
antiques from  
Christmas long ago.  
Enjoy the magic of  
"The Christmas  
Village" for young  
and old alike.  
Starting Nov. 29 and  
running through  
Dec. 22.

## Italia Jewelry

Is Now Offering  
Great Savings On  
Fine Jewelry

Bring in this Ad  
and receive a  
guaranteed  
**10% Off**  
Your Best Deal  
At Italia Jewellery

\*ASK ABOUT OUR NEW FREE VIP CARD  
with your purchase

*Italia Jewelry*

Repairs • Custom Work • Fine Jewelry • Precious Gems  
Master Jewelers

33463 West Seven Mile • Livonia  
(810) 442-7878

Free Layaway • Free Gift Wrap

\*Limited Availability

THE TRUTH  
IN JEWELRY

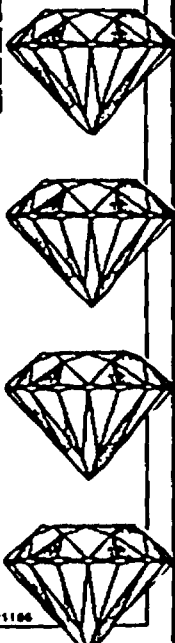

## SNOW ADVISORY

GIVE DAD WHAT  
HE REALLY  
WANTS AND  
NEEDS!

TORO® CCR POWERLITE®  
SNOWTHROWER

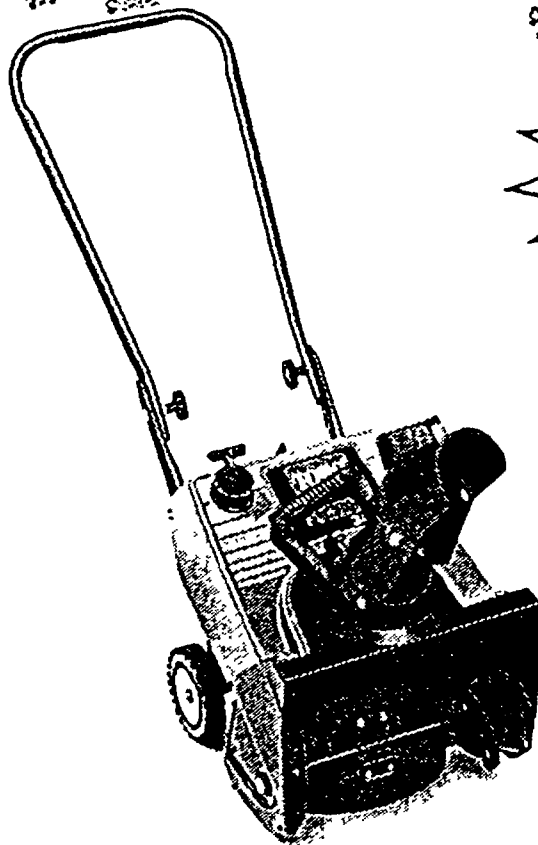

- Exclusive Power Curve® rotor system cleans down to the pavement
- 3 hp engine
- 16" clearing width
- Folding handle for easy, compact storage

SALE PRICE **\$399<sup>00</sup>**

WEIGHS ONLY 38 LBS.  
THROWS SNOW 25 FEET\*

**BAKER'S**  
LAWN AND LEISURE

**TORO**

1155 Milford Rd., Highland  
(810) 887-2410

When you want it done right.

© 1995 The Toro Company

# "MIRACLE ON MAIN STREET" DOWNTOWN NORTHVILLE

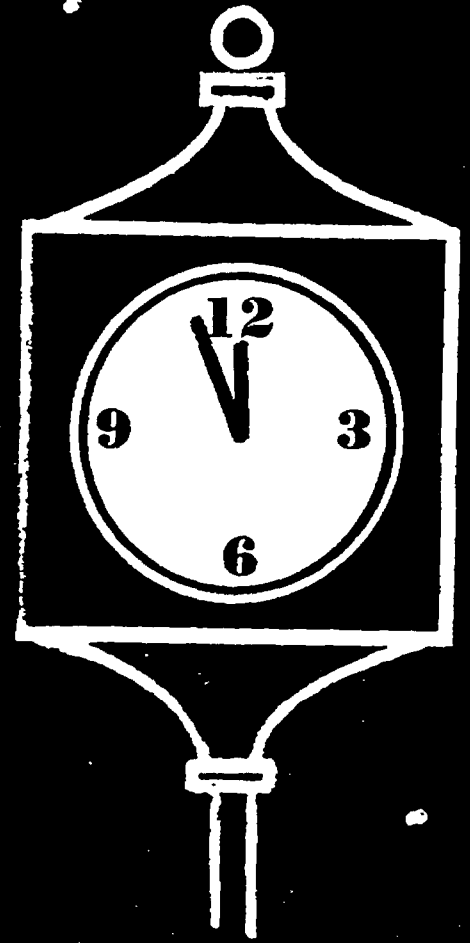

- \* Vintage village atmosphere
- \* One-of-a-kind shops & restaurants
- \* Lots of FREE parking

Look for this sign

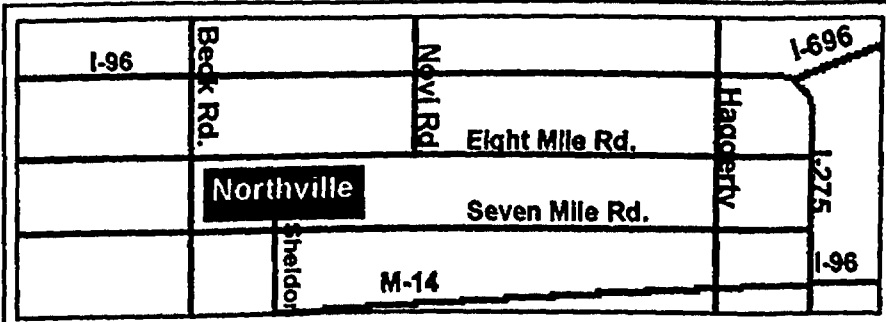

### Special Events

- \* "MIRACLE ON MAIN STREET" PARADE~ Friday evening, 11/22, 6:00. After the parade, until 9:00, visit Santa and his live reindeer at Santa's House, by the Gazebo.
- \* CHRISTMAS WALK~Sunday afternoon, 11/24, 1:00-5:00
- \* CANDLELIGHT WALK~Friday evening, 12/6, 6:00-9:00
- \* CHARITY AUCTION~Sunday afternoon, 12/8, 1:30-3:00
- \* VISITS WITH SANTA ~(Call for hours)

### MIRACLE MERCHANT HOLIDAY HOURS

Monday-Friday 10:00-8:00, Saturday 10:00-5:00, Sunday 12:00-4:00

NORTHVILLE CENTRAL BUSINESS ASSOCIATION, (810) 349-0522 or (810) 348-1213



# It Adds Up to 14 Months of Absolutely NO PAYMENTS and NO INTEREST!

14 = 0 0 0 0

MONTHS UNTIL  
ANY PAYMENTS  
OR INTEREST  
BEGIN

MONEY  
DOWN

MONTHLY  
PAYMENTS'  
UNTIL  
JANUARY '98

% INTEREST  
CHARGED OR  
ACCRUED  
BEFORE  
JANUARY '98

ADDED  
CHARGES!

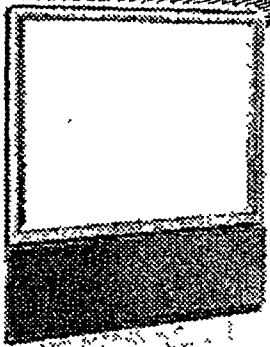

Use your Three Diamond® Card to buy any Mitsubishi TV or VCR between October 24th, 1996 and December 11, 1996, and there is No Down Payment, No Monthly Payments, No Interest and No Accrued Interest Until January 1998!

50" Slim Stereo Big Screen with Two-Tuner Advanced Picture-in-Picture  
Crafted in genuine oak veneer, this slim 50" set offers both performance and convenience. An all-digital, 3-dimensional comb filter ensures a clear, sharp picture. Two tuners allow two channels to be viewed simultaneously.

- Features Mitsubishi's high-performance CRTs, high-efficiency optics and advanced picture technology for a sharp, accurate picture
- Advanced picture-in-picture (sizable, moveable, snapshot, replay, still) allows viewing of 2 programs at the same time, without using a VCR's tuner
- Illuminated multi-brand remote with VCR/cable box control
- Parental Lock: Lock the TV by time and Lock the channel allow you to restrict programming access for children
- 900 lines horizontal resolution; 3D Y/C Comb Filter

If you purchase a Mitsubishi TV, Big Screen or VCR during Mitsubishi's blockbuster event from October 24th, 1996 to December 11, 1996, there's no down payment, no monthly payments to handle and no interest building up from month to month. Payments won't begin until January 1998 and you only owe the original purchase price - no added interest on the preceding months! Interest\* only begins to count in January of 1998 - Yes, January of 1998.



IN-STORE IN-HOME  
SERVICE DEPARTMENT

HOURS  
Monday & Thursday  
8:00 a.m. - 8:00 p.m.  
Tuesday,  
Wednesday & Friday  
8:00 a.m. - 6:00 p.m.  
Saturday  
9:00 a.m. - 5:00 p.m.

# CENTURY

ELECTRONICS  
SINCE 1977

8491 Grand River • Brighton Mall Annex at I-96 - Brighton



(810)227-5422

Livingston  
County's  
Only Full  
Sale &  
Service Store  
- Now in  
Our 20th  
Year!

# Stocking *Available in December!* Stuffers

Need some Stocking Stuffer ideas? Why not fill the stockings with HomeTown Newspapers 1997 Golf Club Card or 1997 Dining Club Card or both? Only \$20 each.



HomeTown  
1997  
Golf  
Club Card

Effective 1997 Golf Season Only!



HomeTown  
Newspapers  
1997  
DINING  
CLUB  
CARD

Your ticket to exciting  
culinary adventures

**Bon Appetité**

Effective Jan. 1 - Dec. 30, 1997

**Call for information:**

(517) 548-2570 (810) 437-4133  
 (810) 348-3022 (810) 227-4436  
 or 1-800-579-7355

# Decorating the home for the holiday season

Continued from 44

how to create handmade ornaments with plastic foam, plaster, spray paint and buttons, and a way to spruce up votive candles with gingerbread house cookies.

Magazines, too, offer fashionable ideas aplenty. Country Sampler's Decorating Ideas produces a holiday edition full of Christmas projects as do dozens of other monthlies.

Quick ways to brighten the decor? Candles, candles and more candles. Clusters of flickering candles are traditional decor whether you celebrate Kwanzaa, Hanukkah or Christmas.

Plain, fragrant or adorned with holiday frills, candles warm any home's appearance.

Next? Potpourri, made from roses or purchased, can be another sensory

feast. To make your own, collect a quart of petals before they turn brown. add 1 tablespoon of fixative (dry lavender or oak moss from herb, spice or drug stores), spray with perfume or add a cinnamon stick or vanilla beans. wrap in sachet and enjoy long after the holidays.

According to Pattie Shaw, style director for J.C. Penney's home furnishings catalogs, "You don't need a big budget or a lot of spare time to create a holiday atmosphere. A few inexpensive shortcuts can make any home special."

Here are a few she suggests:

Fill bowls or glass jars with ornaments or pine cones. Cover everyday throw pillows with festive slipcovers and lampshades with pleated convivial overshades. Drape a mantel scarf over the fireplace, buffet table or dresser. Place a pillar candle in a bowl and fill

with fresh cranberries. Surround a variety of candles with seasonal fruits and decorative ribbons to create a natural centerpiece for the table.

Colors are another way to change your home's look. If you're used to holiday red and green, substitute pearly white and rich gold. And anything with angels is sure to be hot this chilly season.

What else can you do inexpensively? Display holiday quilts, blankets, dinnerware and even greeting cards.

For those who wish to shop to decorate, jovial holiday products are already lining shelves of department and specialty stores. Many families, even those without kids, are turning to lighthearted, nostalgic decorations that evoke special memories from the past. Winnie-the-Pooh fans can find plenty of products starring the friendly Pooh and cohorts in the snow, and through

holiday scenes. Disney's holiday Pooh line, with stockings, kitchen accessories, ornaments and warm blanket throws to festoon any couch, can be found in most large department stores.

The Classic Pooh line, featuring the traditional, old-fashioned Pooh, comes alive in snow globes, music boxes, blankets and Christmas rugs. Classic Pooh, ideal for handing down from generation to generation, is available in upscale specialty shops.

Department 56's extensive line of lighted, tabletop snow homes and buildings makes it easy to create gorgeous winter villages and Dickens-era neighborhoods piece by piece.

The company offers a decorating brochure - Ready, Set, Decorate! - by calling (800) LIT-TOWN, or contacting the Department 56 Web site at [www.department56.com](http://www.department56.com).



**Lepppek**

Design/Build Landscape Contractor  
Nursery - Garden Center

**Spectacular  
Homemade  
Wreaths**

- Fraser Firs • Concolor Fir •
- Beautiful Live Trees •
- Michigan Snowfresh Christmas trees •
- Holiday lights, decorations, ornaments •
- Wreaths • Garland • Cemetery blankets •
- Artificial trees • Craft supplies •
- Snowplowing

**OPEN 7 DAYS**  
73441 W. Grand River  
Brighton  
(810) 227-2566

## DECK THE HALLS!

**SILVESTRI  
MINI LIGHTS**  
The original premium Christmas lights.  
Super-bright, long-lasting bulbs.  
**PREMIUM 50 LIGHT SET**  
Only \$7.99

**BALSAM  
FIR  
WREATH**  
22-24" Extra Heavy  
Only \$7.99

**HOLIDAY GREENS**  
We have a huge selection of the freshest greens in town. Come and see!

**POINSETTIAS**  
A rainbow of colors!  
From \$4.99 to \$49.99

Now \$7.99  
6" pot  
REG. \$9.99

**HOLIDAY ROPING**  
We have a wide selection of premium fresh garlands. Come and see!

**CEDAR ROPING  
SPECIAL**  
60" Heavy Grade  
\$29.99

**HOME & GARDEN  
SHOWPLACE**  
453-5500

**CHRISTMAS HOURS:**  
Mon.-Fri. 9-8 • Sat. 9-6 • Sun. 10-6  
OFFERS EXPIRE 12/1/96

**PLYMOUTH  
NURSERY**  
Christmas in the Country

9900 Plymouth/Ann Arbor Rd.  
Just 10 minutes west of I-275

Hardware Lumber  
**IVERSON'S**  
**SERVICESTAR**  
 GOOD NEIGHBOR.  
 GOOD ADVICE.  
**Home Centers**

**CHRISTMAS  
 TIME  
 SPECIALS**



**REDDY HEATER**  
 PORTABLE FORCED AIR HEATERS

**Heat Dragon Model RLP35-35,000BTU/hr.**  
 Ideal for small garages, shops and remodeling areas. Heats up to 6,500 cubic feet 12 hour run time

**\$159<sup>99</sup>**

RLP35

**Model RLP50 49,500BTU/hr.**  
 For garages, workshops and intermediate size areas. Quiet, compact, lightweight. Can operate on a 20 lb cylinder. Heats up to 9,300 cubic feet

**\$174<sup>99</sup>**

RLP50

**Model RCP80-Variable 30,000 to 73,000 BTU/hr.**  
 Quiet, clean-burning, with piezo matchless ignitor, debris shield and UL listed hose and regulator. Operates on a 20 lb tank at low setting heats up to 13,700 cubic feet.

**\$129<sup>99</sup>**

RCP80

**EVERY REDDY HEATER IS:**

- A source of instant, efficient heat.
- Ready to go right out of the box.
- Easy to handle
- Easily serviced with modular components.
- Designed with simplicity of operation in mind.

**MANY MORE MODELS AVAILABLE  
 Propane and Kerosene All On Sale NOW!**

*GIVE HIM SOMETHING HE REALLY WANTS THIS YEAR!*

**SHOP VAC 1 GALLON PORTABLE WET/DRY VAC**

**\$29<sup>99</sup>**

**Trakita**  
 Cordless Screwdriver  
 Equipped with Electric Brake  
 Model 6791DW  
 With Fast Charger

**9.6V Includes case \$49<sup>95</sup>**

#50551

- Vacuums wet or dry
- Powerful 5.7 amp motor.
- Comes w/4" hose, crevice tool, gulper nozzle, mounting ring and 6'8" power cord.
- Plastic tank won't dent or rust.
- 2 year manufacturer's warranty.

**Rubbermaid**  
**INDUSTRIAL ROUGHNECK**

Tool Chest (35"x13 1/2"x14 1/4") No. 7718.....\$39<sup>95</sup>  
 Tool Chest (36"x18 1/2"x20 1/4") No. 7719.....\$59<sup>95</sup>

- Structural foam material for industrial strength and durability
- Recessed side grips for carrying heavy loads
- Tool Chests have reinforced lid construction to help prevent warping

No 7718 No 7719

**PORTER-CABLE**  
 PROFESSIONAL POWER TOOLS  
 Model 9447  
**\$164<sup>99</sup>**  
 7 1/4" Electric Circular Saw With Case

**VARIABLE SPEED ALL-PURPOSE TIGER® SAW KIT**  
**\$139<sup>99</sup>**

- 9.6 Amp, AC only
- Variable speed switch 0-2600 SPM
- 1-1/8" stroke
- Efficient reciprocating cutting action
- 100% ball bearings
- Pivoting front shoe
- Universal blade clamp
- Carrying case included

Model 9738

**LUMBER • PLYWOOD • ROOFING • INSULATION • CEILING TILE**

**SEAL SKINZ WATERPROOF SOCKS**

100% Guaranteed All Season \$23.99  
 Insulated \$28.99

**FINISH STAPLER**

**JAMERCO INC.**

Full one year warranty

**\$62<sup>99</sup> Each**

Model JTSO61825

Applications:  
 Cabinets & Furniture, Trim & Molding, Crafts & Picture Frames, Lightweight, Compact, Powerful  
 Carrying Case Included

**BRAD NAILER**

**JAMERCO INC.**

Model JTBN1832

**SLB1M BLACK & DECKER SNAKELIGHT**

**\$23<sup>99</sup>**

Flexible core for hands-free lighting. Can be bent, coiled, draped or wrapped into various positions. High-intensity Xenon bulb for maximum light. High-impact ABS construction for durability. Includes 2 C cell batteries and a spare bulb.

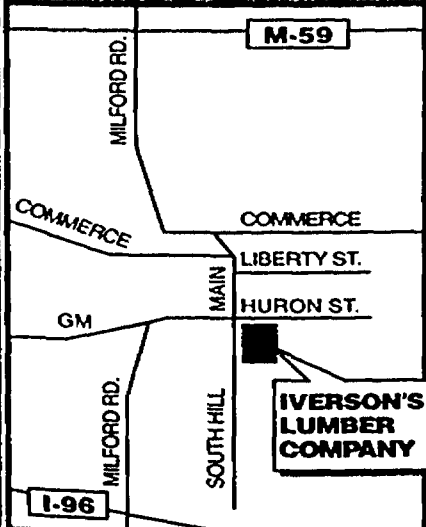

**EVERYTHING IN BUILDING NEEDS AND MASONRY SUPPLIES**

**300 E. Huron St. • Milford**

**685-8702**

ALL ITEMS CASH & CARRY

Sale Prices Good Thru December 23rd

HOURS: Mon.-Fri. 7:30 a.m. - 6 p.m.  
 Saturday 8-4; Sunday 10 a.m. - 2 p.m.

# HO HO HO! I HOPE IT SNOWS!

If it snows 4" or more this New Year's Eve, you will get a **100% CASH REFUND** (excluding sales tax) on all purchases made between December 1st and Christmas!

See store for details  No purchase necessary  

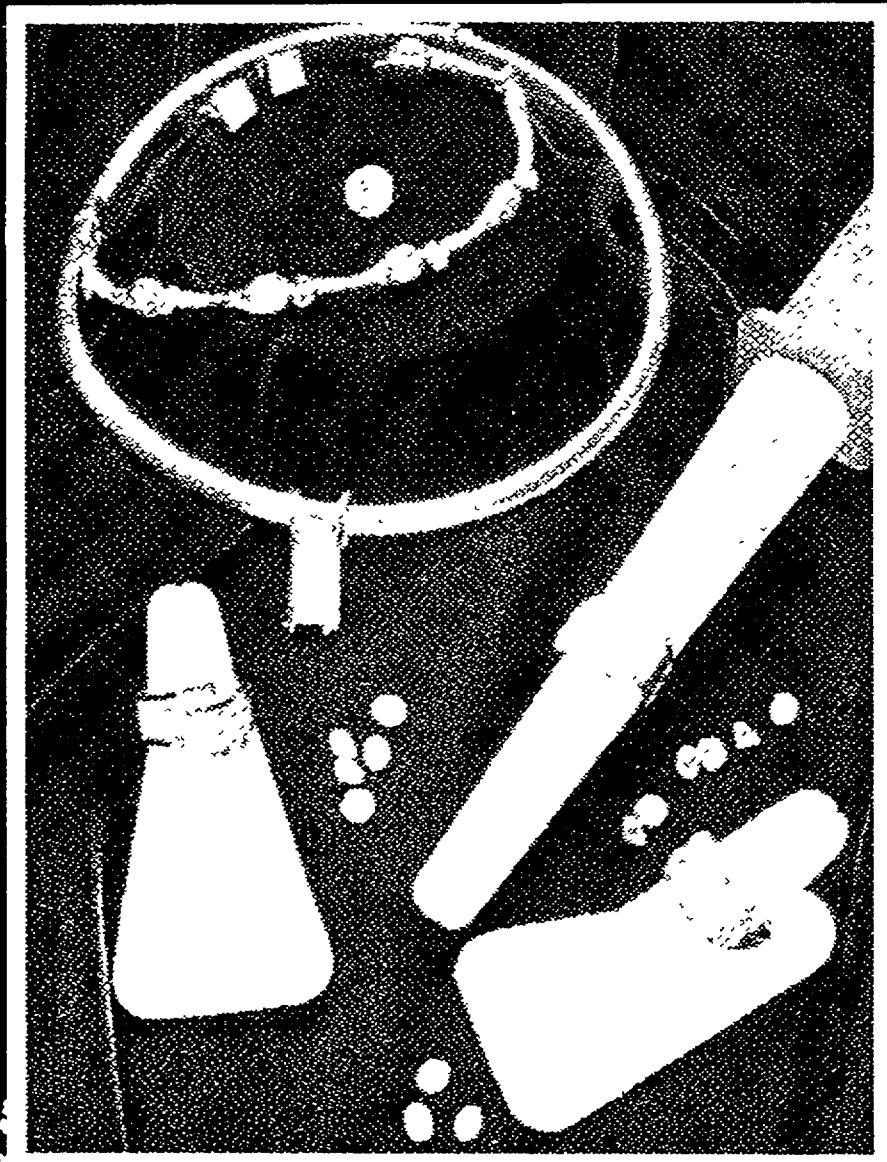

**Lowest  
Prices**

**Reliable  
Service**

**High  
Quality**

**Super  
Selection**

**Guaranteed!**

*Only  
at*

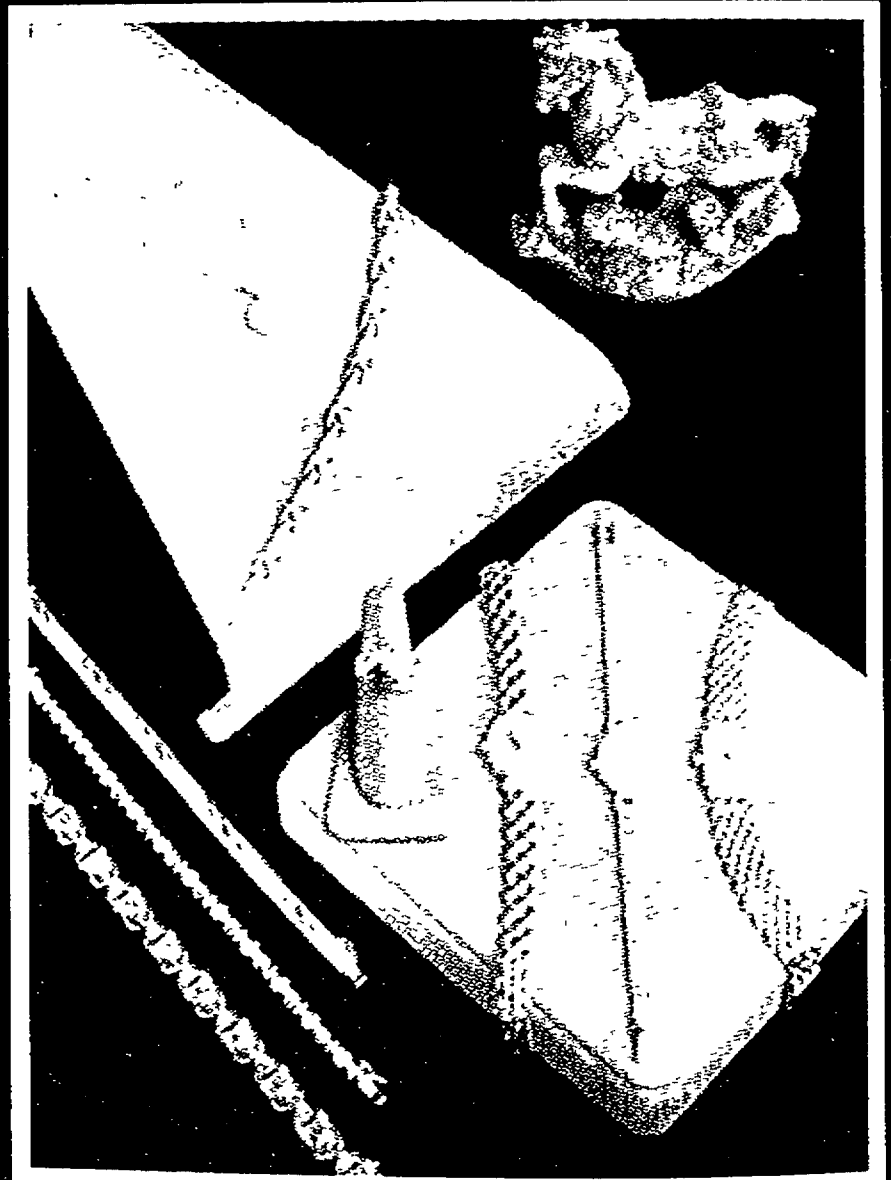

## SHOP AND COMPARE!

**Free Gift Wrapping  
Shipping Services Available**

**All Major Credit Cards  
Accepted!**

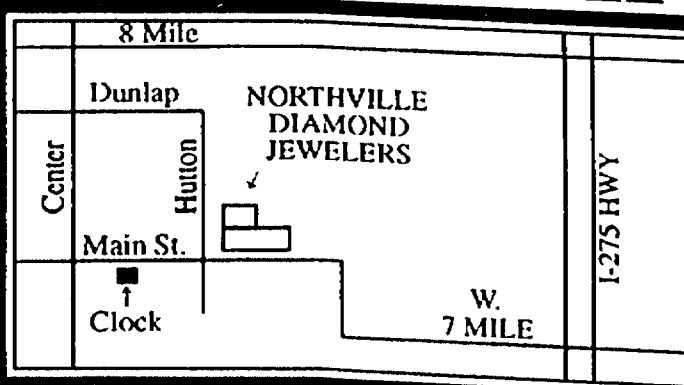

**Holiday Hours:**  
Monday-Friday 10a.m.-8p.m.  
Saturday 10a.m.-6p.m.  
Sunday 12p.m.-5p.m.

201 East Main St. at Hutton (across from Presbyterian Church) Downtown Northville • (810) 348-6417

YOUR COMMUNITY GUIDE TO  
**SANTA'S HOLIDAY SECRETS**



## Restore Your Marble To Its Natural Beauty

Experts in Marble Restoration & Preservation

Bring out the natural beauty, color & sheen for a lustrous finish - with the professionals at **MARBLELIFE**



**MARBLELIFE** uses modern care technologies to restore, preserve and seal marble, terrazzo and other dimensional stone.

Experts also in Corian countertops and ceramic tile. Rely on the experts at **MARBLELIFE** to keep your new and older marble looking exquisitely pristine.

**MARBLELIFE**

FREE ESTIMATES  
**1-800-459-6870**

## Send a "Little Bit of Michigan" to friends and family anywhere.



**EVERGREEN WREATH.** Our traditional, natural evergreen wreath is hand-made from Balsams, Cedar, pine, and Blue-berried juniper, trimmed from a northern Michigan forest after a late fall frost. The wreaths are made only one day before shipping to insure freshness. They are decorated with natural pine cones and a colorful waterproof bow. Overall diameter is about 22". The perfect size for a door or window.

**\$24<sup>95</sup>**  
Includes shipping  
4% Michigan sales tax

**MICHIGAN SAMPLER.** SOMETHING FOR THE WHOLE FAMILY. The gift box contains the Evergreen Wreath, Home-made Apple Butter, Peach preserves, Michigan Honey, and Maple syrup candy. Includes a card with your holiday message or you can include your own.

**\$34<sup>95</sup>**  
Includes shipping

**PLATT ROAD FARM & GREEN HOUSE**  
1-800-400-8964 or 1-313-439-3314

## CHRISTMAS SHOPPING BLOWOUT SALE!

Inline Skates, Snowboards  
Service, Sales & Rentals

**20%** off all 1996 Recreational and Roller Hockey Skates

Your Headquarters for:  
**K2 • Oxygen • Roces  
Misson • Palmer  
Hyper • Senate**

**50%** off all 1996 Snowboards Boots & Bindings  
Expires: 12-1-96

Family Specials & Team Discounts

# BLADESPORTS

43427 JOY ROAD • CANTON • (313) 207-8606  
CHRISTMAS HOURS: Mon.-Sat. 10-9 Sun. 11-6

Continue The Tradition  
Of Giving Ft....



**\*FREE POINSETTIA**  
with the purchase of  
1 Dozen Long Stem Roses at..... \$12.99  
or  
25 Long Stem Roses at..... \$24.99

\* (Poinsettia comes in a 4 1/2 pot valued at \$4.99)

**1-800-353-2977**

Hours:  
M - W 9:00-6:00 p.m.  
Thurs. & Fri. 10-7 p.m.  
Sat. 9-6  
Closed Sunday

42047 Ford Road • In the Sears Hardware Plaza • Canton  
Fax (313) 981-7968 Ph. (313) 981-8382

Chamber of Commerce Member



## Backyard Birds

Garden & Nature Store  
More than just a feed store!  
Over 110 Birdfeeders to choose from

Serving the bird enthusiasts in  
Plymouth and Wayne County

**\$5<sup>00</sup> OFF**  
any purchase over \$30.00  
OR  
**\$10<sup>00</sup> OFF**  
any purchase over \$50.00

Limit one coupon per purchase.  
Not valid with any other offer.  
Offer valid with this coupon until 12-24-96

**627 S. Main St.  
Plymouth  
416-0600**

Mon.-Fri. 10-6  
Sat. 9:30-5:30 Sun. 11-5

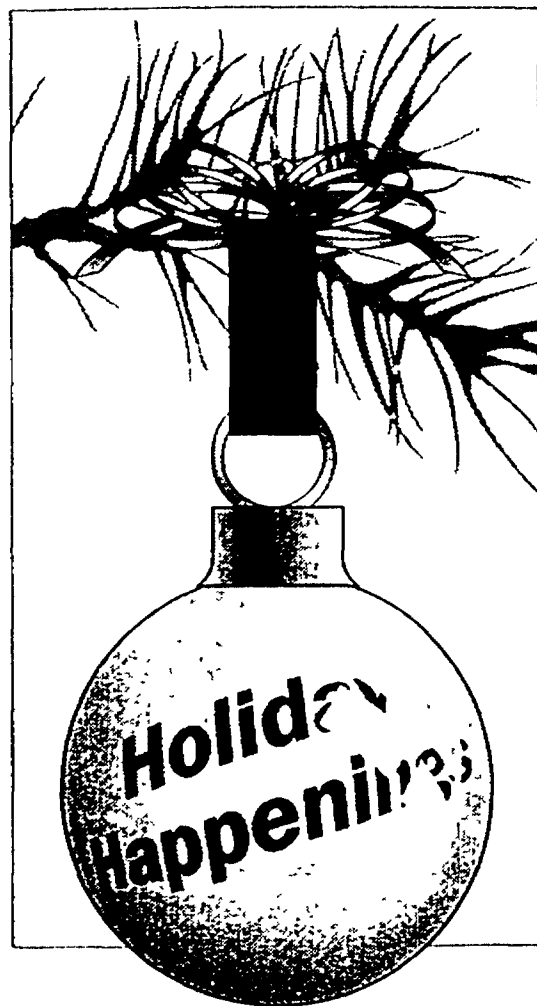

**LIGHT SHOWS**

**HINES PARK**

Wayne County LightFest is four miles of giant animated characters. The display is open nightly 7-10 p.m. Nov. 21 through Jan. 1 (closed Dec. 25) in Wayne County's Hines Park. Enter at Hines Drive and Merriman between Warren and Ann Arbor Trail in Westland, 2 1/2 miles south of I-96. The donation is \$5 a car. For information, call (313) 261-1990.

**DOMINO'S FARMS**

The Christmas Light Display will be open 6-10 p.m. every evening through Dec. 31 at Domino's Farms, which is on Earhart Road off Plymouth Road about one-half mile east of U.S. 23. Minimum donation is \$5 a vehicle weekdays and \$7 a vehicle Fridays, Saturdays and Sundays with proceeds to benefit charities.

**SANTA BREAKFASTS**

**HUDSON'S WESTLAND**

Breakfast with Santa will be served at Hudson's at Westland Center at 9:30 a.m. Dec. 8 and Dec. 22. Adults and children are invited to a hot breakfast, along with an interactive skit telling the story of a young boy's wish to become a firefighter and the fire safety lessons he learns from Firefighter Phil. After breakfast, the children are able to meet Santa Claus. Reservations are required, and there is an \$8 charge per person, plus a 50-cent service charge per order. Guests may reserve a seat by calling (800) 272-2450.

**PARADE**

**SANTALAND**

The Santaland parade in Garden City will be held at 10 a.m. Saturday, Nov. 30. The parade starts at Maplewood and Middlebelt then moves south to Ford, west to Merriman and south into City

Park.

**CLASSICAL**

**PLYMOUTH SYMPHONY ORCHESTRA**

"The Nutcracker Ballet," 8 p.m. Friday, Dec. 13, and 3 p.m. Saturday, Dec. 14-Sunday, Dec. 15, Plymouth-Salem Auditorium, Plymouth-Salem High School, 46181 Joy Road, Canton. \$15 adults, seniors and college students; \$8 children. (313) 451-2112.

**CHORAL**

**PLYMOUTH COMMUNITY CHORUS**

"Christmas Celebration 1996," 8 pm. Thursday, Dec. 5-Friday, Dec. 6, 4 p.m. and 8 p.m. Saturday, Dec. 7, and 4 p.m. Sunday, Dec. 8, in the sanctuary of First United Methodist Church, 45201 N. Territorial Road (West of Sheldon), Plymouth Township. \$8 tickets available at Sideways Gift Shop, 505 Forest (313) 453-8312; Evola Music, 215 W. Ann Arbor Road, Plymouth (313) 455-4677; The Northville Record, 104 W. Main, Northville (810) 349-1700; and at the door. (313) 455-4080/(313) 425-1208.

**SCHOOLCRAFT COLLEGE COMMUNITY CHOIR**

"Yuletide Tapestry," 4 p.m. Sunday, Dec. 8, First Presbyterian Church of Plymouth, 701 W. Church St. (at Main Street), Plymouth. \$4; 8 p.m. Saturday, Dec. 14, St. Matthew's United Methodist Church of Livonia, 30900 Six Mile Road (between Merriman and Middlebelt roads), Livonia. Donations will be accepted during intermission. (313) 462-4448.

**POPS**

**LIVONIA SYMPHONY ORCHESTRA**

"White Christmas" benefit featuring popular music, food and festivities, 6 p.m. Thursday, Nov. 5, Italian-American Club, 39200 Five Mile Road (west of Newburgh), Livonia. \$40. (313) 421-1111 or Awrey Bakery (313) 522-1100; "Magical Musical Christmas" featuring guest vocalist Kimberly Haynes, magician "Al the Only," and popular musical festivities, 7:30 p.m. Saturday, Dec. 14, J.P. Carli Auditorium, Churchill High School, Newburgh and Joy roads, Livonia. \$10, by mail at 30499 Plymouth Road, Livonia, MI 48150. Ticketmaster outlets, or at the door. (313) 421-1111 or (810) 464-2741

**DETROIT SYMPHONY ORCHESTRA**

"Colors of Christmas" concert with Roberta Flack, Peabo Bryson, Aaron Neville, and Melissa Manchester, 8 p.m. Friday, Dec. 13 and Saturday, Dec. 14, \$20-\$75; "Christmas Pops," with Conductor Robert Bernhardt, 8 p.m. Thursday, Dec. 19, 8:30 p.m. Friday, Dec. 20 and Saturday, Dec. 21, 3 p.m. Sunday, Dec. 22, and 7 p.m. Sunday, Dec. 22, Detroit Opera House, Detroit. \$16-\$58. (313) 833-3700

**KENNY ROGERS**

"The Gift of Christmas" Concerts 8 p.m. Friday, Dec. 6, 2 p.m. and 8 p.m. Saturday, Dec. 7, 3 p.m. and 7 p.m. Sunday, Dec. 8, Fox Theatre, 2211 Woodward Ave., Detroit. \$15-30. (313) 983-6611/(810) 433-1515

**HOLIDAY SPECIALS**

See HAPPENINGS, A7

hats vases  
gourmet foods  
sewnies candlesticks  
gloves jackets rugs  
chargers jewelry  
furniture lamps  
framed art florals  
birdhouses topiaries  
fountains trays napkins  
runners soaps pillows  
wreaths sandals angels  
music boxes sachets headbands  
greeting cards mirrors silks  
scarves ottomans urns  
cassets coasters silk fruit  
napkin wrings decorative boxes  
sweet temptations note cards  
ornaments garlands floral arches  
guest towels silk cakes brassware purses  
pot pourri childrens furniture throws  
decorative light switches socks sweaters  
porcelain silverplate baskets candles  
holiday stockings tree skirts  
tablecloths table toppers cake plates  
decorative silk cupcakes gourmet sugars  
floral arches bath salts plate hangers  
teapots creamers and sugars holiday ribbons  
shelves tray tables candlestick lamps dried florals  
fairies cassimers pottery decorative fabrics trims  
wallpaper and oh... so much more.....

**The Velvet Plum**  
distinctive designs  
595 Forest at Wing Plymouth (313) 207-0666

**FORGET THE MISTLETOE!**

Give her the ring she's always hoped for at the savings you've always wanted.

Come see our new building and showroom

**O & D Bush Jewelers**

Graduate Gemologist Donald E. Bush  
509 Ann Arbor Trail • Plymouth • 455-3030  
Between Lily & Main

FREE GIFT WRAPPING

- All Major Credit Cards Accepted
- Extended Christmas Hours
- FREE Lay-a-Way



Happy Holidays from  
**Minerva's Dunnings**

**SPECIAL SALE ON ALL  
 LADIES & CHILDREN'S OUTERWEAR**

See our fine line of Holiday wear and accessories. Lovely robes,  
 lingerie and sportswear for ladies and children. New  
 merchandise arriving every day!

*Minerva's Dunnings*

500 Forest Avenue 453-0080  
 Holiday Hours: Mon-Fri. 10-8, Sat. 10-6, Sun. 12-5

Take Advantage  
 of  
 Holiday  
 Sale



**What's on your list?**

Diamonds - Pearls - Gemstones  
 Watches - Unique Gifts

**Crystal Diamond Setters**  
 "Your Hometown Family Jeweler"

467 Forest, Plymouth (313) 453-5290

Visa - American Express  
 Mastercard - Discover

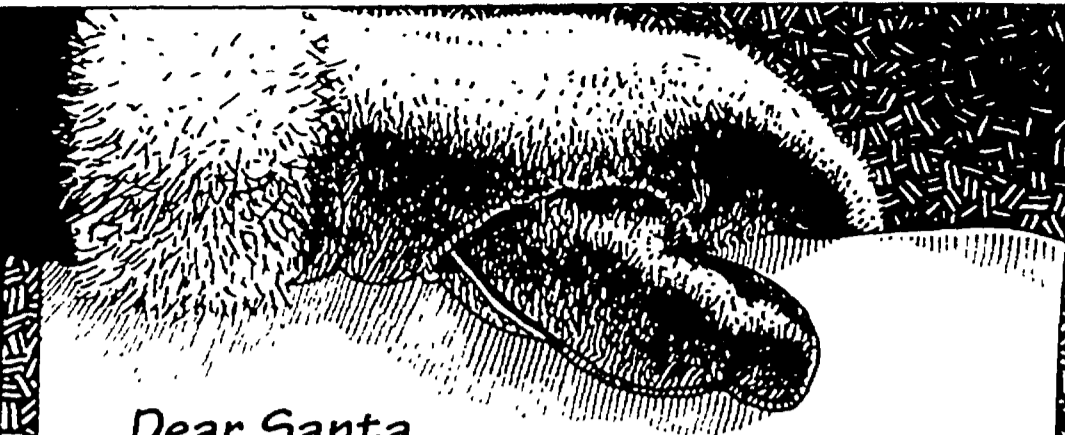
Dear Santa,  
 You can find everything on my  
 Wish List at Riders Hobby Shop!

Radio-Controlled Planes, Boats,  
 Helicopters and Automobiles.  
 And please don't forget the Trains,  
 Games, Plastic Models,  
 Telescopes and Slot Car Sets!

Sincerely,  
 A Very Good Boy!

**RIDER'S**  
 HOBBY SHOPS

42007 Ford Road (1/4 Mile west of I-275) Canton  
 (313) 981-8700

**RENT THIS  
 CARPET  
 &  
 UPHOLSTERY  
 CLEANING  
 MACHINE**



Cleans  
 like a  
 Truck  
 Mount.

**\$19.99**

**Delivered!**

24 HOUR RENTAL  
 (Solution Available \$11.00)

We supply all equipment including  
 Turbo Air Mover for quick drying

**Pro Steam Express**  
 CALL ANYTIME  
**(313) 454-1438**

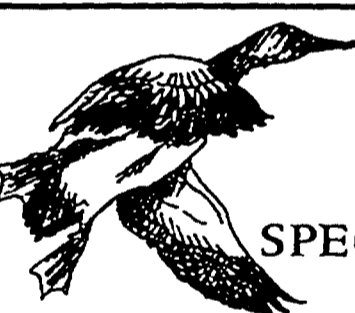

**S & R Wildlife  
 Art Gallery**

SPECIALIZING IN WILDLIFE ART  
 - CONSERVATION FRAMING -  
 Representing Most Major Publishers & Artists  
 Limited edition Prints, Collector Plates, Decoys & Figurines

"Trimming the Tree"  
 Sixth Annual  
 Limited Edition  
 Christmas Print

America's Most Popular Artist!  
**Terry Redlin**

We Have A Large  
 Assortment of  
 Terry Redlin Gifts  
 and Collectibles



Detail shown.

**ALL STATE & FEDERAL STAMP PRINTS**

33163 FORD RD., GARDEN CITY, MI  
**(313) 261-6860**

# GIVE THE GIFT THAT ENHANCES THE QUALITY OF LIFE

This Christmas season consider those who need special assistance and give them the quality of life they deserve. There is no better gift than a gift that enables personal freedom and independence.



The Comfort Lift Chair/Power Recliner will get you up and moving with ease. The entire chair raises for maximum support and positioning with a variety of seat angles. Continuous power recline features helps you recline with little effort. Large choice of color fabrics are available.



Wheelchairs don't come any tougher than the Tracer LT. Designed to meet the special needs of the most demanding user. Along with the rugged design, many styles and models are available.



The Pride Celebrity Scooter is a medium to large size all purpose, indoor/outdoor scooter. Pride scooters offer an innovative and exciting new form of personal mobility which many people could use to enjoy a more active and rewarding life-style. Pride scooters also offer many models to choose from.

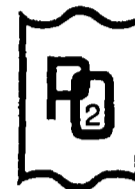

**PRESCRIBED OXYGEN SPECIALISTS, INC.**  
47784 Halyard  
Plymouth, MI 48170

*"Specializing in Home Medical Equipment Sales and Service"*

Visit Our Showroom

Monday - Friday  
8:30 am to 5:30 pm

Saturday  
9:00 am to 2:00 pm

**CALL 1-800-922-5340**

J.C.A.H.O. Accredited  
BCBSM SUPPORT Program Provider  
VISA/MASTERCARD and Most Insurances Accepted

Bring Your Holiday Gift List To . . .

## CHRIS' HALLMARK



*Snowbabies*

*Lilliput Lane.*



*Hallmark*

**BEANIE BABIES™**



*Seraphim Classics™*  
*Heaven on Earth*

We carry a wide selection of:

- Collectibles
- Boxed Cards
- Gift Wrap
- Keepsake Ornaments
- Home Decor
- Candles
- Holiday Partyware

**MERRILY PLUSH BEAR**

Only \$9.99



**FREE**  
Gift Wrapping Service with purchase of Gift Wrap

**CHRIS' HALLMARK COUPON**

**\$3.00 OFF**

your purchase of \$15.00 or more  
Excluding Precious Moments, Cherished Teddies and Snowbabies

NOT VALID WITH ANY OTHER OFFER  
Limit 1 per customer • Expires 12-15-96

**CHRIS' HALLMARK COUPON**

**\$5.00 OFF**

your purchase of \$25.00 or more  
Excluding Precious Moments, Cherished Teddies and Snowbabies

NOT VALID WITH ANY OTHER OFFER  
Limit 1 per customer • Expires 12-15-96

VISIT ANY OF OUR LOCATIONS AT:

**COVENTRY COMMONS • CANTON**  
Joy Rd. and Morton Taylor Rd.  
313-207-7776

**SOUTHGATE SHOPPING CENTER**  
Trenton and Eureka Rds.  
313-285-0522

**SOMERSET PLAZA • TROY**  
W. Maple & Coolidge Rds.  
810-649-4940

LS21433



## VIDEO JACK

After a day of holiday shopping,  
relax with a great  
movie, game or audio book!

VIDEO JACK

**RENT ONE, GET ONE  
FREE!**

Excluding New Releases\*Expires Dec. 15, 1996

<p><b>LIVONIA</b> 36400 Five Mile (Across from St. Mary Hospital) (313) 464-7733</p>	<p><b>FARMINGTON</b> 34785 Grand River (2 Blocks E. of Drake) (810) 473-1124</p>
--	--

Beat the holiday rush. . .

## Interior TECHNIQUES

- In Home Service
- Pleated Shades
- Cornice Boards
- Wallpaper
- Re-Upholstery
- Columns & Pedestals
- Custom Pillows & Comforters
- Vertical & Horizontal Blinds

*We Specialize in Custom Draperies*

**\$100 Off** Your first order, excluding wallpaper and showroom accessories



**(313) 953-4030**  
12-12 to 6 PM  
10-11 to 6 PM  
Sat. 10 to 5 PM

37661 Five Mile Road • Livonia  
(S.W. Corner of Five Mile & Newburgh)



**453-8584**

**GRAND OPENING**  
at our new location  
550 Forest Ave.  
in Westchester Mall  
Dec. 12th - Dec. 14th



Petite-4XL  
Hours: Monday - Friday 10-7  
Saturday 10-6, Sunday 1-4

### Gifts of Love in Lingerie

- 1997 Swimwear • Lingerie • Warmwear •
- Bustiers • Body Suits • Backless Bras •
- Maternity • Men's Silk • Professional Bra and  
Swimwear Fitters 32A-56DD • 34E-48H •

**20% OFF**  
**BRAS, PANTIES, LINGERIE**  
Does not include Special Orders or foundations  
May not be combined with other offers  
Expires 12-14-96

*Holiday  
Fashion Show*  
**Thurs., Dec. 12<sup>th</sup>**  
**7 p.m.**

## Michigan Made Inc.

Home of Michigan Made Products



GWEN FROSTIC • PEWABIC POTTERY  
BULLFROG CANDLES  
&  
Lots of Michigan Foods  
Books & Lighthouses

**830 W. ANN ARBOR TRAIL • DOWNTOWN PLYMOUTH**  
**(313)207-8494**

## Holiday Skate Shop Specials

from  
**SKATIN' STATION II**



**Speed Skate**  
SP204  
**\$84<sup>00</sup>**

We also carry:

- Conventional roller skates • Blade skates
- Speed skates • Roller Blade hockey skates & equipment • Holiday Gift Certificates

*We Service & Sell replacement parts for most models*

**ALL NIGHT SKATE**  
Saturday, December 7th  
7:30 p.m. - 7:00 p.m.  
AGES 14 & UNDER  
\$15.00 \*Skate Rental \$1.75  
Includes Papa Joe's Pizza & McDonald's Breakfast



8611 Ronda Drive • Canton, MI 48187

**SKATIN' STATION II**  
8611 Ronda Drive • Canton  
**(313) 459-6400**

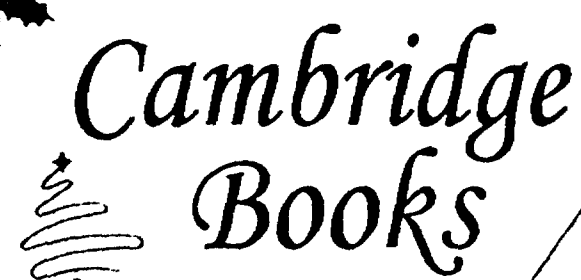

## Cambridge Books

**The BEST  
Discounts**

**Large  
Selection**

**Great Gift  
Ideas!!**

**Next to Kmart  
on Ford Rd**

**459-6493**



Continued from A3

**HOLIDAY AT GREENMEAD**

Visit Greenmead and discover the charm of Christmas Past. Hill House Museum and village buildings are decorated for the holidays by Questers and Greenmead volunteers. Tours will be available 1-4 p.m. Sundays, Dec. 1, 8, 15, 22. Admission is \$2 for adults and \$1 for children.

Free concerts in Newburg Church at Greenmead, Newburgh south of 8 Mile, are:

- Dec. 8, 3 p.m. Livonia Civic Chorus;
- Dec. 15, 2 p.m. Transfiguration Orthodox Church Choir, 3 p.m. Finnish Center Choir;
- Dec. 22, 2 p.m. Silver String Dulcimer Society, 3 p.m. St. Genevieve Children's Choir.

**TREE LIGHTING**

Westland's annual Christmas tree lighting ceremony at City Hall will be at 6:15 p.m. on Monday, Dec. 2. The program features the singing of Christmas carols in front of City Hall and the arrival of Santa Claus. After the ceremony, refreshments are served at city's main fire station.

**HANDBELL CONCERT**

St. Michael Handbell Ensemble will present a special free holiday concert 7 p.m. Monday, Dec. 2, in the auditorium of Livonia Civic Center Library.

**CHRISTMAS WALK**

Friends for the Development of Greenmead will present the Christmas Walk 10 a.m. to 5 p.m. Saturday, Dec. 7. Seven homes, beautifully decorated for the holidays by local florists, shops, and home owners, may be viewed in various Livonia locations. Proceeds will help restore the Alexander Blue House at Greenmead Historical Village. Tickets

are \$7 per person in advance and \$8 at the door and are available from committee members, all Livonia libraries including the Civic Center Gift Shop, or from the department of community resources on the fifth floor of Livonia City Hall.

**CANDLELIGHT DINNER**

The Italian American Club of Livonia will present its Adult Holiday Candlelight Dinner beginning 5 p.m. Sunday, Dec. 8, in the Italian American Club Banquet Facility, 39200 Five Mile at I-275. Tickets at \$30 each includes a traditional holiday meal with dancing. Tickets, Tressa at 810-349-8880, Vince 313-953-9724.

**CELEBRATION OF LIGHTS**

Daniel Lord Council 3959 Knights of Columbus presents "Sarnia Celebration of Lights" starting noon Dec. 8 at \$59.75 per person. Bus departs 39100 Schoolcraft in Livonia and returns about 9:45 p.m. The Guse Family's Christmas show includes high-stepping, fiddling and singing. Also included is a tour of Sarnia's Celebration of Lights and dinner in Sarnia. Make checks payable to "Seniors Unlimited" and mail to Dan Crowley, 9911 Shadyside, Livonia 48150. 422-4065.

**HOLIDAY TOURS**

The Plymouth Symphony League presents "Holiday Homes and Hosts" 10 a.m. to 9 p.m. Sunday, Dec. 8. One rectory and nine homes in the Plymouth, Canton and Northville communities will be decorated for a holiday tour to benefit the Plymouth Symphony Orchestra. Pre-sale tickets are available at The Velvet Plum, 595 Forest Place, 207-0666; Beitner Jewelry, 904 W. Ann Arbor Trail, 453-2715; Piccadilly's House & Garden, 873 N. Mill Street, 454-9220; and Friends in Northville, 123 E. Main, 810-380-6930. Pre-sale price is \$12.50 per ticket, day of tour \$15 at the homes. Raffle items reflecting a theme of the home will be available at several of the holiday homes. Information, K.C. Mueller at 455-0075 or Carol at 459-3189.

**THEATER**

**DETROIT OPERA HOUSE**

"The Nutcracker" with the Detroit Symphony Orchestra and the Michigan Opera Theatre, Dec. 5-22, at the Opera House, 1526 Broadway, Detroit. 8 p.m. Thursday, Dec. 5 to Saturday, Dec. 7, 2 p.m. and 7 p.m. Sunday, Dec. 8, 8 p.m. Thursday, Dec. 12-Friday, Dec. 13, 2 p.m. and 8 p.m. Saturday, Dec. 14, 2 p.m. and 7 p.m. Sunday, Dec. 15, 8 p.m. Thursday, Dec. 19, 2 p.m. and 8 p.m. Friday, Dec. 20-Saturday, Dec. 21, and 2 p.m. and 7 p.m. Sunday, Dec. 22. \$13-\$35; matinees half price for children and seniors, \$6.50. (313) 833-3700

**GEM THEATRE**

"The All Night Strut! Holiday Show," Friday, Nov. 29-Tuesday, Dec. 31. at the theater, 58 E. Columbia (across the street from the State and Fox theaters), Detroit. 7:30 p.m. Wednesdays (\$23), 7:30 p.m. Thursdays (\$23), 7:30 p.m. Fridays (\$28), 6 p.m. and 9 p.m. Saturdays (\$28), and 2 p.m. Sundays (\$23) and 6 p.m. Sundays (\$19). Group

See HAPPENING, A11

**Specialty PET SUPPLIES**

Check this list for everyone on Santa's Paw List...

- Real Brass Jingle Bell Collars
- Christmas Bandanas
- Designer Pet Food Bowls
- Stuffed Candy Canes
- Cat Nip Toys
- Beds Galore
- Coats & Sweaters
- Squeaky Dog Toys
- Brass Charms
- Rawhide Canes & Bones
- Hamster Treats
- Bird Toys
- Santa Hats
- Cat Furniture
- Christmas Cookies
- Bird Feeder Seed
- Bird Cages
- Gift Certificates
- Dog & Cat Stockings
- ...and much more

"Say hello Santa"

**WE HAVE HUMANE SOCIETY & ANTI-CRUELTY CHRISTMAS CARDS**

**Holiday Gift Ideas**

**PORCELAIN BY ROSALINDE**

MOST POPULAR BREEDS IN STOCK OR ORDER YOUR FAVORITE BREED ON QUALITY PORCELAIN MERCHANDISE

- Cups • Plates
- Steins • Tea Sets
- Jewelry Boxes and Many Other Items

SPECIAL ORDER DEADLINE 12/10/96

**INVITATION**

**VIPP Members Only**

**SUNDAY, DEC. 1, 1996**

**NOON TO 5:00 P.M.**

**HOLIDAY SHOPPING SPREE - DOUBLE DISCOUNTS!**

**20% OFF ALL Regular Priced Merchandise**

**10% OFF ANY Iams or Eukanuba Pet Food**

P.S. You MUST bring this ad or present your V.I.P.P. card to receive discounts.

Sign Up For Your Membership Now & Receive **\$5.00 OFF V.I.P.P. CARD**

New or Renewal Regular \$15.00 Membership

With This Coupon • Coupon Expires 11-30-96

**Specialty PET SUPPLIES**

1498 S. Sheldon • Plymouth At Ann Arbor Rd. across from Kroger

**(313) 453-6930**

HOURS: Mon. - Fri. 10-7:30 Sat. 10-6 Sun. 12-4

OPEN CHRISTMAS EVE TIL 3 PM

"AMERICA'S MOST FAMOUS ARTIST"



"TRIMMING THE TREE"  
Sixth Annual Limited Edition Christmas Print  
A Limited Edition Lithograph By TERRY REDLIN  
Edition of 19,500 s/n 18 1/2 x 32" • \$225

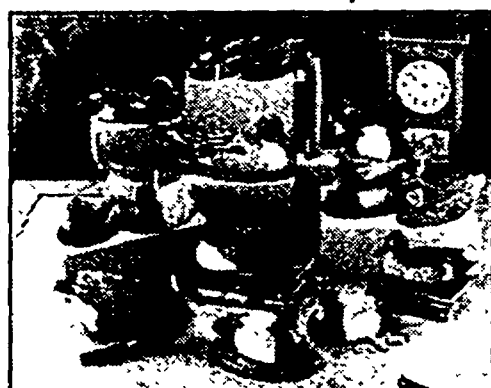

Wild Wings

A very "Special Place" for the nature lover and sportsman!  
Wild Wings features Wildlife and Nature Art, Carvings, and many related gifts in addition to home or office decor items. We invite you to plan a visit soon for a rewarding experience. We are sure you will find that unusual gift for that special person!  
Our holiday hours beginning, November 29th are Monday thru Friday 10-9, Saturday 10-6, Sunday 12-5.

Call or write for a free catalog.  
388 S. Main, Plymouth, MI 48170  
455-3400

N A W R O T  
Pendleton Shops

Please Visit Our Newly Expanded Store  
Now Featuring Casual Home Furnishings,  
Gift and Blankets  
Plus...

SAVE 20% ON ANY ONE ITEM  
WITH THIS AD

470 Forest  
Plymouth, MI 48170  
Holiday Hours:  
Mon.-Fri. 10-9; Sat. 10-6; Sun. 12-5  
(313) 459-0440

Accent Bin

"When You're Looking  
for That Special Gift"

FLAGS, FLAGS, FLAGS  
and windsocks, too, of course  
MICKEY, PEANUTS, GARFIELD  
even "Old Paint" the horse  
BEENIE BABIES-Camille Beckman  
Hand therapy and lots, lots, more....



960 W. Ann Arbor Tr., Plymouth (313) 455-9510

Open weeknights 'til 9 p.m.; Sat. 10 a.m. to 6 p.m., Sun. noon to 5 p.m.

Just in for the holidays

LIFT-MASTER.  
THE GARAGE DOOR OPENER  
PROFESSIONAL INSTALLERS  
CHOOSE FOR THEIR HOMES.

Exceptional Power And  
Performance Plus \$15  
Back On The Installation.

WHY THE PROS  
RECOMMEND LIFT-MASTER:

Durability / Long Life

- Durable steel construction for years of dependable use.
- Power to lift all types of garage doors.

Unequaled Quality

- Computer tested for dependable performance

Safe Operation

- The Protector System® electronic-eye safety device automatically reverses garage door if anything obstructs it going down.
- Manual release in case of power failure.

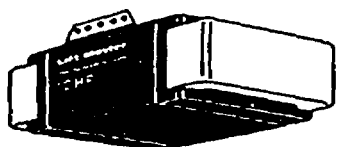

MODEL 1260  
1/2 H.P. Chain Drive  
With 2-Hand Transmitters  
NOW ONLY \$210<sup>00</sup>

INSTALLATION EXTRA \$65.<sup>00</sup>  
\*Mail-in offer good  
11/25/96 - 12/31/96

Lift-Master  
The Professional Line

VALUABLE COUPON

FREE  
Keyless Entry System  
(\$35 Value)

The Keyless Entry System lets you open your garage door from outside without your remote control or keys  
Expires 12-31-96



FARMINGTON GARAGE DOOR

29033 GRAND RIVER • FARMINGTON HILLS

(810) 477-2380

V.H.P. Floorcovering

29155 Plymouth Rd.  
Livonia • M-F 9-5, Sat. 9-2 [313] 422-7130

NEW CARPET

In Stock Carpet Rolls  
• Philadelphia • Salem • Aladdin  
• Sutton • World • Queens

\$5.95

Per Sq. Yd. and Up

USED TRADE SHOW CARPET

Great for Rentals, Basements,  
Family Rooms, Cottages, and more!

\$1-\$4.95

Per Square Yd.

CARPET REMNANTS In a Variety of Sizes and Styles



A Gift For You...  
THE WORKS!

10% OFF  
Any Multi-Service Pkg.  
(either Ours or Yours)  
Also good toward any Multi-  
Service Gift Certificate.  
GOOD THRU DEC. 15, 1996

Come in before the  
Holidays and treat  
yourself to our  
complete makeover  
...or give one as a  
gift with one of our  
Special Holiday  
Gift Certificates!



TANTALUS  
Total Makeover Salon  
(313) 421-0078

Located in the LA Plaza • Livonia  
36135 Plymouth Road Just E. of Levan

# Your Christmas Store

Over 50 different styles of natural looking trees

Fantastic selection of indoor and outdoor lights

Hundreds of tree trimmings in a variety of themes

Fontanini nativity sets

Variety of Beautiful Wreaths and Garlands

Scrappin' Classics Angels

## CORNWELL Christmas World

874 W. Ann Arbor Road  
PLYMOUTH

(313) 459-7410

A. Roman, Inc.

Hours;  
Mon.-Thurs.-Fri. 10-8  
Tues.-Sat. 10-6; Sun, 12-5;  
Closed Wed.

PRE-LIT  
CHRISTMAS  
TREES

by

A. Roman, Inc.

# Gifts You'll Open Again & Again

**FREE GIFT WRAP**



- Newly Expanded Selection of Books
- Magazines
- Newspapers
- Cards
- Stationery
- Cassettes
- Gifts
- Free Gift Wrapping
- Gift Certificates
- Special Orders
- Phone Orders
- Mailing Services
- Special Discounts to businesses and organizations
- Discounted New York Times best sellers

**EXTENDED HOLIDAY HOURS**  
 MON.-THUR. 9:30-10:00  
 FRI. & SAT. 9:30-11:00  
 SUNDAY: 8:00-6:00

All Major Credit Cards Accepted

A Little Professor Book Center

*Little Professor on the Park*

380 South Main Street • Plymouth • Telephone 455-5220

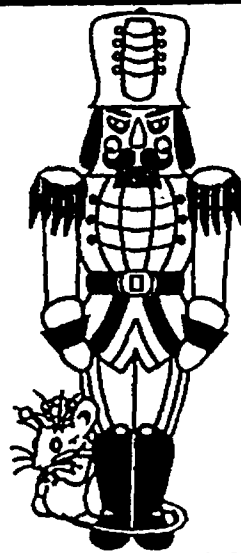

## Nutcracker

Order CD's at \$17 including Postage

Join us for this Plymouth Symphony and Plymouth-Canton Ballet Company holiday tradition. Tchaikovsky's tale of Clara's enchanting Christmas eve has delighted audiences since 1892 and we promise to continue this tradition.

FRIDAY DEC. 13, 8 P.M.  
 SATURDAY DEC. 14 3 P.M.  
 SUNDAY DEC. 15, 3 P.M.

Plymouth - Salem High School Auditorium  
 46181 Joy Rd. Canton MI

This Advertisement Sponsored By:

**Delta Diamond**  
 SETTERS & JEWELERS

*Now Open!*



INVITATIONS  
 ANNOUNCEMENTS  
 FINE PAPERS & GIFTS

*Distinctive paper products for all your special occasion needs*

\*\*\*

- ...Christmas Cards
- ...Holiday Invitations, Napkins, and Wrap
- ...Fine Stationery
- ...Specialty Gifts
- ...Unique Stocking stuffers for the entire family!

\*\*\*

*Free gift with this ad and the purchase of \$25.00 or more*

829 Penniman, Plymouth  
 (313) 455-7229

## Bring your gift list to KACEE'S Hallmark Gold Crown!

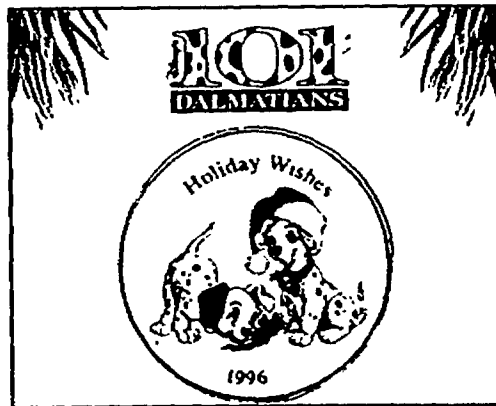
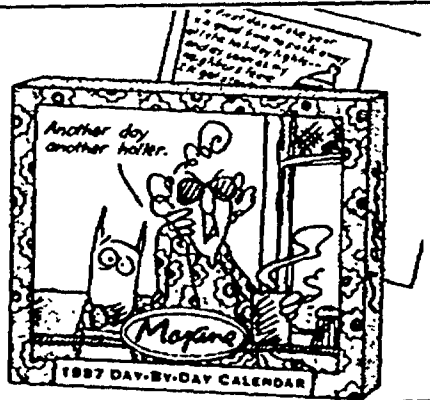

**BUY ONE CALENDAR GET THE 2ND ONE**

**1/2 OFF**

*Of equal or lesser value. One per customer • With Coupon Expires 12-24-96. Not valid with any other offer and previous purchases.*

**BUY \$20<sup>00</sup> worth of holiday ornaments and receive**

**a FREE Greeting Card**

*Up to a \$2.50 value. One per customer • With Coupon Expires 12-24-96. Not valid with any other offer and previous purchases.*

**KACEE'S** Hallmark

LIVONIA  
 6 Mile & Farmington  
 (313) 427-2505

W. BLOOMFIELD  
 6645 Orchard Lake  
 (810) 851-8685

NORTHVILLE  
 119 N. Center St.  
 (810) 348-0290

NOVI  
 43151 Crescent Blvd.  
 (810) 344-4588

WHITE LAKE  
 10871 Highland Rd.  
 (810) 698-3250

Also Locations in Sterling Heights & Chesterfield

# DECK THE HALLS!

## SILVESTRI MINI LIGHTS

The original premium Christmas lights. Super-bright, long-lasting bulbs.

PREMIUM 50 LIGHT SET

Only \$7.99

## BALSAM FIR WREATH

22-24" Extra Heavy

Only \$7.99

## HOLIDAY GREENS

We have a huge selection of the freshest greens in town. Come and see!

## POINSETTIAS

A rainbow of colors!  
 From \$4.99 to \$49.99

Now \$7.99

6" pot  
 REG. \$9.99

## HOLIDAY ROPING

We have a wide selection of premium fresh garlands. Come and see!

## CEDAR ROPING SPECIAL

60' Heavy Grade  
 \$29.99

**PLYMOUTH NURSERY**

Christmas in the Country

9900 Plymouth/Ann Arbor Rd.  
 Just 10 minutes west of I-275

HOME & GARDEN SHOWPLACE

453-5500

CHRISTMAS HOURS:  
 Mon.-Fri. 9-8 • Sat. 9-6 • Sun. 10-6  
 OFFERS EXPIRE 12/1/96





\$45. (313) 833-3700 . . .

**DANCE**

**THE HARLEM NUTCRACKER**

With The Harlem Nutcracker Band and its band leader Marcus Belgrave, and The Willis Patterson Our Own Thing Chorale. 8 p.m. Wednesday, Dec. 18-Friday, Dec. 20, and 2 p.m. and 8 p.m. Saturday, Dec. 21, Power Center, 121 Fletcher, Ann Arbor. \$16-\$28; \$10 children and \$20 adults for 2 p.m. show. (800) 221-1229

**CHURCHES**

**CHRISTMAS PAGEANTS**

Covenant Community Church will present "Four Tickets to Christmas" Friday, Dec. 6, and Sunday, Dec. 8, at the church, 25800 Student St., north of Five Mile Road, Redford. Dinner will be at 6:30 p.m. with the performance at 8 p.m. on Dec. 6, with the performance at 6 p.m. and dinner at 8 p.m. on Dec. 8. Tickets cost \$10 in advance. For more information, call (313) 535-3100.

• Temple Baptist Church will present its The Glory of Christmas pageant, "The Journey of the Fourth Wise Man," at 7:30 p.m. Friday and Saturday, Dec. 6-7, 13-14 and 20-21, and a 6 p.m. Sunday, Dec. 15, at the church, 23800 West Chicago, Redford. Tickets cost \$6 each for balcony and main floor seating. Mail-in orders postmarked by Nov. 11 will be processed in the order received before tickets go on sale to the community on Monday, Nov. 18. Children under age 4 will not be admitted due to the length of the production and child care will not be provided. For more information, call the church's ticket hotline at (313) 255-3339.

**NEW YEAR'S EVE**

**DINNER DANCE**

Don S. Hubert VFW Post Number 345 will host a New Year's Eve Dinner Dance Tuesday, Dec. 31. Doors open at 7 p.m., dinner at 7:30 p.m.. Casual dress. Music by DJ. B.Y.O.B. No ticket sales at door. For reservations call Dan, 359-3467, after 5 p.m.

**GALA**

The Italian American Club of Livonia will present a New Year's Eve Gala beginning 7:30 p.m. Tuesday, Dec. 31, in Italian American Club Banquet Facility, 39200 Five Mile at I-275. Tickets at \$65 each includes dinner, refreshment, Temp band, favors, and a midnight snack. Angelo 313-591-0240, Vince 313-953-9724.

**AREA EVENTS**

**DETROIT ORATORIO SOCIETY**

"Handel: Messiah" featuring Apollo's Fire, the Cleveland Baroque Orchestra, 8 p.m. Thursday, Dec. 12, Orchestra Hall, 3711 Woodward Ave., Detroit; 8 p.m. Friday, Dec. 13, First United Methodist Church, 1589 W. Maple Road, Birmingham. \$18; \$25 reserved. (810) 650-2655

**HANDEL'S MESSIAH**

With the UMS Choral Union and Ann Arbor Symphony Orchestra, 8 p.m. Dec. 7, and 2 p.m. Dec. 8, Hill Auditorium, 530 S. State St., Ann Arbor. \$8-\$16. (800) 221-1229

Continued from A7

discounts available. New Year's Eve performances: 7 p.m. \$45; and 10 p.m. \$60 includes a champagne toast and dancing afterward. (313) 963-9800

**FAMILY EVENTS**

**DETROIT SYMPHONY ORCHESTRA YOUNG PEOPLE'S CONCERT**

"It's a Cowboy Dave Christmas: The Great Reindeer Round-Up," 11 a.m. and 2 p.m. Saturday, Dec. 7, Orchestra Hall, 3711 Woodward Ave., Detroit. \$7-\$27. (313) 833-3700

**FRANKLIN VILLAGE HOLLY DAY**

Featuring ice sculptures, performance by The Merry Munchkins, Hanukkah dreidel game, visit from Santa, carolers, horse-drawn carriage tours, fire station open house, complimentary refreshments, villagewide lighting contest, Menorah lighting, Salvation Army Band, and a "Light Up A Life" sweater drive, 9 a.m.-9 p.m. Saturday, Dec. 7, throughout Franklin Village. (810) 626-6589

**NOEL NIGHT**

Featuring carols, art, Santa, culture and carriage rides, 4-8 p.m. Saturday, Dec. 7, in the University Cultural Center, Wayne State University campus, Detroit. (313) 577-5088

**NORTHVILLE CHRISTMAS WALK**

With free holiday treats, Christmas carols, and special activities in local stores, noon-5 p.m. Sunday, Nov. 24, downtown Northville shops. Local organizations will sell holiday items including Christmas wreaths, evergreen roping, fresh holly, the Music Boosters' pumpkin bread, popcorn and cider. There will also be free horse and carriage rides with Santa. (810) 349-7640

**JAZZ**

**"WINTER SOLSTICE"**

With the Turtle Island String Quartet and Tuck & Patti, 8 p.m. Saturday, Dec. 28, Detroit Opera House, Detroit. \$10-

**Village Shopkeeper**

**Handmade Amish Furniture**

- Deacon Benches
- Rockers
- End Tables
- Cedar Chests
- Bookcases & Hutches



**Amish Wooden Toys**

- Wooden Wagons
- Tables & Chairs
- Rocking Horses
- Doll Furniture
- Trains

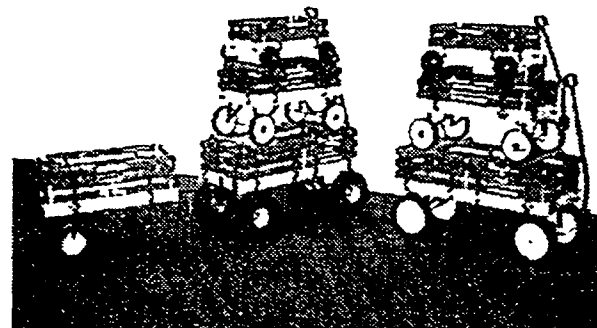

**Exclusive Daisy Kingdom Children's Clothing**

Custom Embroidery



**Great Gift Ideas**

- A.I. Root Candles & Bullfrog Candles
- Copper Craft Brass Afghans & Pillows



**FREE A.I. ROOT VOTIVE**

with purchase of \$5.00 or more with this ad!

Downtown Plymouth • 470 Forest Place Mall  
(313) 455-6060



# HOLIDAY

*Headquarters*

**DISCOUNT DRINKS**  
 8673 Lilley CANTON 451-1222  
 HOURS: Mon-Sat 9-9, Sun 12-5  
 "Your One Stop Beverage Center"

<b>TOSTI ASTI 1.5 Lt.</b> \$12.99 WITH COUPON \$8.99 MAIL-IN REBATE \$4.99 FINAL NET COST Plus Tax With Coupon • Expires 12-15-96	<b>Budweiser &amp; Bud Light</b> 18 pk. Only \$8.99 + tax + dep. Whole Supplies Last With coupon • Expires 12-15-96	<b>Harvey's Bristol Cream</b> 750 ml \$10.00 \$2.00 MAIL IN REBATE \$8.00 With coupon • Expires 12-15-96
<b>SUMMIT 4 LT. Wine Box</b> \$6.00 Reg. \$7.99 Plus Tax With coupon • Expires 12-15-96	<b>SEAGRAMS Ginger Ale</b> 99¢ 12 pk. cans Plus Deposit • Plus Tax • Whole Supplies Last With Coupon • Expires 12-15-96	<b>BERINGER</b> \$4.00/750 ml Bottle Plus tax With Coupon • Expires 12-15-96

**MANCO**  
 The worlds oldest and largest manufacturer of Fun-Carts!!!

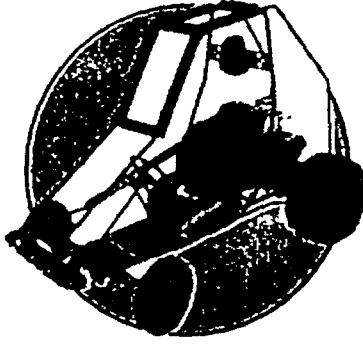

Canton Tractor has a machine for you. Starting at \$639.00 with horse-power ranging from 3.5hp to 13hp.

**Canton Tractor Sales**  
 42045 Michigan Ave.  
 Canton, MI 48188  
 313-397-1511  
 1/2 Mile West of I-275

**Tahitian NONI**  
 100% PURE TAHITIAN NONI  
 THE MAGIC OF TAHITI IN ONE INCREDIBLE PRODUCT!

**HEALTH NEWS**  
 THE NATURAL JUICE OF THE NONI FRUIT HAS BEEN USED TO IMPROVE HEALTH IN TAHITI FOR 2000 YEARS.  
 NOW, IT HAS COME TO AMERICA AND IS HELPING THOUSANDS BY RELIEVING PAIN AND ENCOURAGING HEALING.  
 AND...IT WORKS IN DAYS...NOT WEEKS OR MONTHS.

come to a free meeting at Denny's Restaurant at Ann Arbor Rd and I-275, Mon. Dec. 2, 7-9pm. To hear the story of Noni and testimonials from the growing number of real people who have been helped. Free literature and tapes available. Don't miss your chance!

FOR QUICK INFORMATION CALL (313) 454-7668

**Arts & Crafts Show**  
 FRI., DEC. 6 • 3 p.m.-9 p.m.  
 SAT., DEC. 7 • 10 a.m.-7 p.m.  
 SUN., DEC. 8 • 12 p.m.-5 p.m.

- Face Painting
- Personalized Calendars • Bring Your Favorite Photos!

**NOVI EXPO CENTER**  
 • FREE PARKING •  
 Spaces Still Available • Call (313) 421-2445  
 Admission \$3.00 • Children Under 12 Free

**Christmas Gift Ideas That Will WARM YOUR HEART**

**We Carry:**

- Gas B•B•Q's & Replacement Parts
- Ventless Gas Stoves
- Woodburning Stoves
- Fireplace Supplies
- Lots of Christmas Gift Ideas

Take An Extra **15% OFF** Any In Stock Gas Logs



**10% OFF ALL TOOL SETS & ACCESSORIES**  
 Floor Displays Only! Expires 12-24-96

**Heat'n Sweep**  
 8545 Lilley Rd. • Canton • (313) 455-2820  
 (In Golden Gate Shopping Center)  
 Near Bob's of Canton)  
 Hours: M, W, F 10-6; T, TH 10-8; SAT. 10-5; SUN 11-3



**Holiday Gifts from PFAFF**



**#1;**  
Pfaff tipmatic 6085  
21 Stitches plus buttonhole, Blind Hem, with case.  
Reg. \$799  
Sale Price \$499

**#2**  
Pfaff tipmatic 6091  
21 Stitches plus button hole, blind hem, with case plus Pfaff exclusive Dual Feed.  
Reg. \$999  
Sale Price \$699

**#3**  
Pfaff tipmatic 6122  
30 Stitches plus buttonhole and dual feed.  
Reg. \$1199  
Sale Price \$899

**Pfaff tipmatic 7570**  
World's finest computerized sewing machine working with the most advanced embroidery hoop system any where.  
Save \$1000

**Anderson Sew 'n Vac**  
34170 PLYMOUTH ROAD • LIVONIA  
(between Wayne and Farmington)  
Extended Holiday Hours: M - F 10-5 Th 11-7 Sat. 10-4

*Happy Holidays!*



For Young Engineers on the Grow

**BRIQ**

*The Pied Piper of Plymouth*  
350 S. MAIN ST.  
(across from the Park)  
Downtown Plymouth  
(313) 459-3410

*A Christmas Wish \* \* A Christmas Wish \* \* A Christmas Wish*

**The Perfect Gift... That is Sure to Fit!**

*Alexander the Great and Showcase Cinemas present:*



the **\$25<sup>95</sup>** **MOVIE & DINNER PACKAGE**  
Includes 2 dinners and 2 movie tickets

Great gift idea for Employee Bonus/, the babysitter, secretary, parents, grandparents and "the person who has everything!"  
Gift Certificates Sold at Alexander the Great

**Give One For The Holidays!**

**Alexander THE GREAT**

34733 Warren Road • Westland  
1 blk. E. of Wayne Road • Open Daily 11-1; Sun. 12-10  
(313) 326-5410

Master Card  
VISA  
AMERICAN EXPRESS

*A Christmas Wish \* \* A Christmas Wish \* \* A Christmas Wish*

**PLYMOUTH MARKETPLACE**

110 W. Ann Arbor Rd. at Lilley Rd. • Plymouth • (313) 453-2535  
HOURS: Mon.-Fri 9 a.m.-7 p.m. Sat. 8 a.m.-7 p.m. Sun. 9 a.m.-6 p.m. • Bakery Opens Mon.-Sat. 7 a.m.

*The Ultimate Gourmet Shopping Experience...  
For The Ultimate Holiday Buffet!*

- Butcher Shop Meats
- Farm Fresh Produce
- New York Style Deli
- Poultry & Seafood
- Bakery Shop/Cafe
- Cappuccino Bar
- Sandwich Shop
- Full Service Floral Department
- Gift Baskets
- Party Trays

Flowers & Gift Baskets Shipped Anywhere  
1-800-Petals 5

Domestic & Gourmet Beers  
Micro Brews & Fine Wine Selection



FTD

*Your One-Stop Christmas Shop*

**WREATHS**  
from 10" to 36"  
Balsam  
Mixed Balsam  
Douglas Fir  
Nobel Fir

**ROPING**  
Cedar • White Pine  
50 ft. Cedar from \$19<sup>99</sup>

**CLYDE SMITH & SONS**  
NOW OPEN, 7 DAYS

**QUALITY POINSETTIAS**  
4-8-8 and 10 inch pots  
\$4<sup>99</sup> and up  
Red, White  
Pink & more  
Quantity Discounts Available

**Premium Quality FRESH CUT CHRISTMAS TREES**  
Douglas Fir  
Scotch Pine  
Fraser Fir  
Blue Spruce  
From 5 to 9 ft.

**Premium Full Size GRAVE BLANKETS**  
19<sup>99</sup> and up

\$2.00 OFF Christmas Trees  
\$1.00 OFF Grave Blankets  
Made to Order  
50% OFF Poinsettias 6" and up

Coupon Good While Supply Lasts

**CLYDE SMITH & SONS GREENHOUSES**  
8000 NEWBURGH • WESTLAND • 425-1434  
HOURS: OPEN 7 DAYS 9-7 P.M.





**CARPET TWO ROOMS GET ONE ... FREE!**

What A Great Gift for the Holidays!  
We Will Come Directly to Your Home and let you select your carpet colors from our top quality brands (or come to our showroom)!

**You'll Never Beat Our Prices And Our Sale Never Ends!**

**ESTIMATES • SALES • INSTALLATION**  
Philadelphia - Salem - Cabin Craft - Sutton - Aladdin - World - Mohawk  
**BERBER SPECIALISTS**  
Directly From The Mill To You  
Anso Crush Resister, DuPont Stainmaster, Scotchguard Xtralife

**IF YOU HURRY - WE CAN HAVE YOUR CARPET INSTALLED BEFORE SANTA COMES DOWN THE CHIMNEY!**

**FILTER QUEEN and SHARP VACUUMS SOLD AT LOW LOW PRICES!**

**RECEIVE A \$50 MOUNTAIN JACK GIFT CERTIFICATE WITH PURCHASE OF 40 YARDS OR MORE**

**CARPET • LINOLEUM • HARDWOOD FLOORS**  
Serving The Tri-County Area In Floor Care Since 1974  
**J&R Industries**  
27488 Schoolcraft • Livonia  
**(313) 525-5211**

\*FREE ROOM consists of specialty carpet and pad...also labor up to 16 yards.



**MERLE NORMAN®**

For gifts that make **Christmas** even more beautiful.

**Holiday Magic Gifts under \$25<sup>00</sup>**

LIP & NAIL GIFT	COLOR GIFT	SKIN CARE GIFT	BRUSH GIFT
4 Fabulous Shades	Blush, Powder Eye Shadows Mascara, Bag	Cleanser, Toner, Moisturizer, Treatment	4 Brushes plus Travel Bag

So bring this certificate into the **Farmington Merle Norman** today and pick up the gift of a beautiful holiday.

**MERLE NORMAN®**  
**DOWNTOWN FARMINGTON**  
23348 Farmington Rd., Just South of Grand River  
(810) 477-3033  
New Hours: Mon., Tues., Wed., Fri. 10-6; Thur. 10-8; Sat. 10-5

Hey, where did you get all of those great Christmas gifts? The Mall?

No Way! I got them at Venture Outdoors in Downtown Plymouth, They had a great selection of unique items not found in every store.

What did you get?

I got a Gortex jacket for my dad, an Alps sweater for my mom, a stuffed Boyds Moose for my lil sister and for my brother a pair of Smith ski goggles and a fleece jacket plus I got myself a pair of new hiking boots.

Wow, one stop shopping!

They had free gift boxes and because I'm a preferred customer I received a permanent discount for all of next year!\*

Well forget the malls I'm off to venture outdoors. Are they Located on Penniman Ave. across from the Post office?

Yep, and they are open till 8 PM from Monday till Saturday and Sunday 12 to 5 PM.

**Venture Outdoors**

Hours:  
Mon-Sat 10-8pm  
Sun 12-5pm  
(313) 453-1987

24 HOUR SKI TUNING AVAILABLE  
\*See Store for Details



**The Gift as Traditional as Christmas Itself!**

Famous quality, fashionable styles and dust-free storage!



Reg. \$665  
sale \$445

"Bountiful" Distressed pine finish with award-winning front design. 45x18"x24" H.

The complete line of LANE® Cedar Chests are now on sale and available for Christmas Delivery. Hurry in today for best selection!

Reg. \$495  
sale \$329

Since 1933  
**Walker/Buzenberg**  
fine furniture

240 NORTH MAIN STREET • PLYMOUTH • 459-1300  
Mon., Thurs., Fri. 10-9 • Tues., Wed., Sat. 10-6 • Sun. 1-5  
90 Days Same As Cash Available

## All Our Best for a Crafty Season...

- UNIQUE Gift Items
- Holiday Wreaths
- Christmas Decorations
- Gift Bags & Tissue
- Fine Jewelry & Costume Jewelry
- Greeting Cards
- Gift Certificates

Over 1200 Local Craft and Antique Dealers Display  
Their Merchandise on a Daily Basis

### Countryside Craft Mall & Antiques

4 LOCATIONS

**WALLED LAKE** - (810) 926-8650  
1154 E. Maple Road Bet. Decker & Pontiac Trail

**LIVONIA**  
(313) 513-2577  
35323 Plymouth Rd

**STERLING HEIGHTS**  
(810) 977-1633  
40700 Van Dyke at 18 Mile Road

**FLINT**  
(810) 230-0885  
4333 Miller Road

Walled Lake Map

**Extended Hours:**  
Mon thru Sat 10-8  
Sun 11-5

## PLYMOUTH TRAIN SHOP

Mike's Train House  
Lionel A.F.K-Line.  
Accessories  
G., HO., O. Service

### 10% OFF

585 W. Ann Arbor Trail  
Plymouth, MI 48170  
**(313) 454-7337**

Next Door  
(to Saxton's)

Mon.-Fri. 11-7  
Sat. 11-6  
Sun. 11-5

Offer expires 12-31-96

## Visions of Sugarplums and Christmas Eve Dreams...

Sumptuous Handmade...

- Fudge & Nut Brittles
- Chocolates & Truffles
- Sugarless Candies

Custom Filled...

- Holiday Tins
- Gift Bags
- Mugs

GRUNWALD'S  
*House of Fudge*

& Fine Homemade Confections

13 Forest Place • Plymouth  
459-1990

OPEN  
7  
DAYS

# Ho... Ho... Ho... I Hope it Snows!

Would you like to get ALL the jewelry you purchase this Holiday Season  
**FREE\***

**Diamonds**

**Tennis Bracelets**

**Diamond Earrings**

**Wedding Rings**

**Certified Diamonds**

**Engagement Rings**

**Diamond Pendants**

## SHOP & COMPARE

### We Guarantee:

Large Selection • LOW PRICES • Reliable Service

**Northville Diamond Jewelers**

Designers      Manufacturers

**14 Kt. Italian Gold**

**Necklaces & Bracelets**

**Slides/Enhancers**

**Omega Chains**

**Pearls**

**Gold Earrings**

**Swiss Watches**

**HOLIDAY HOURS:**

Mon-Fri 10am-8pm

Sat. 10am-6pm

Sunday 12 noon-5pm

201 East Main St. at Hutton (across from Presbyterian Church) Downtown Northville • (810) 348-6417

\* If it snows on New Year's Eve, you will get a 100% cash refund (excluding sales tax) on all purchases made between December 1st and December 24th! See store for details No purchase necessary

Okay, guys. Here it is, once and for all.

# "THE BOTTOM LINE"

on what she *really* wants for Christmas.

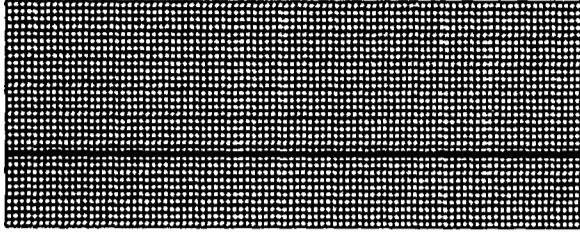

← Vacuums, tools, guns, fishing poles, blenders, slippers, and books

Quality fine jewelry. →

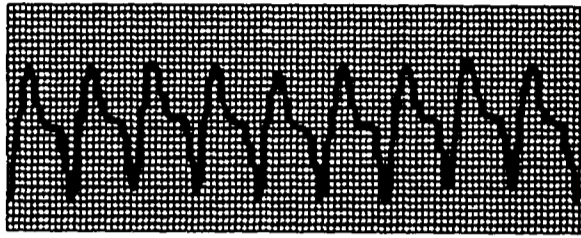

**AND YOU CAN TAKE THAT ONE TO THE BANK.**

Come see us. We specialize in the one she *really* wants.

*Plymouth*  
*Jewelry & Gifts*

HOLIDAY  
HOURS START  
11-29-96  
MON. - SAT.  
10-8  
SUN. 12-5

620 Starkweather • Plymouth • 453-1860

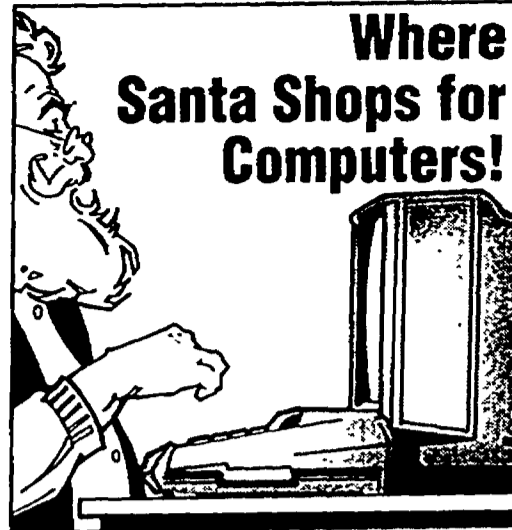

Where  
**Santa Shops for  
Computers!**

**COMPUTERIZE Inc.**  
IBM COMPATIBLE COMPUTERS

CD ROM  
8x-\$130  
10x-\$200  
12x-\$250

- DIGITAL DISPLAY CASE • MON OR DESKTOP
- 3.5" or 5.25" FLOPPY DRIVE
- 2 SERIAL/1 PARALLEL PORTS
- 8 MEG. RAM - 16 RAM ADD \$60
- 104 KEY WING6 STYLE KEYBOARD
- SVGA 14" COLOR MONITOR 280P NON-AT
- SVGA VIDEO CARD 1 MEG. RAM PCI
- 256K PIPELINED CACHE MOTHERBOARD
- 850 MEG. HARD DRIVE-1.2 GIG. ADD \$50
- 3 YEAR WARRANTY PARTS AND LABOR



ADULT  
CD ROMS  
IN STOCK

90 DAYS  
NO PAYMENT

WE MEET OR BEAT  
COMPETITION PRICES

RAM SALE  
1-322 32MB \$38  
2-322 64MB \$58

PENTIUM-75 \$850 PENTIUM-100 \$875

PENTIUM-120 \$900 PENTIUM-133 \$950

PENTIUM-150 \$1000 PENTIUM-166 \$1150

PENTIUM-200 \$1450 PENTIUM PRO-200 \$1800

MULTIMEDIA STARTING AT \$150 CALL

Software • Accessories • Service • Delivery • Financing

15076 MIDDLEBELT, LIVONIA

313-427-0102

Mon.-Fri., 10-8 • Sat., 10-6 • Closed Sun

After  
Thanksgiving  
**SALE**

Friday, Nov. 29  
10 - 8

Saturday, Nov. 30  
10 - 6

**20% OFF**  
Everything

*Cheryl's*  
CLOSET

926 W. Ann Arbor Trail  
Plymouth, MI 48170

(313) 459-3211

## Memory Lane Antiques

**Fine Antiques,  
Collectibles, and  
Estate Jewelry**

336 S. Main St.  
Plymouth  
313-451-1873

Open 7 days a week.

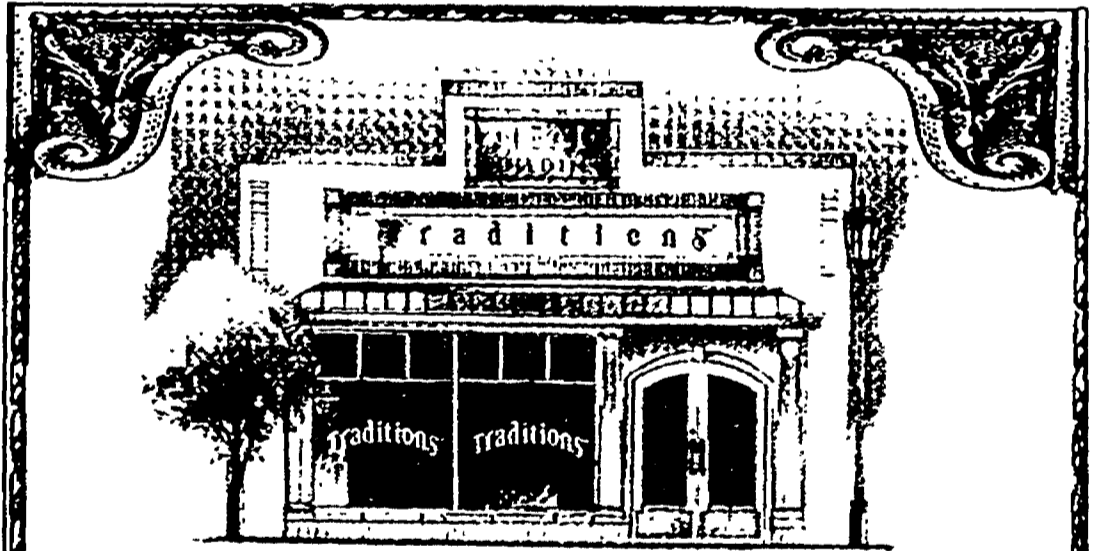

- Woven throws • Wreaths
  - Pilgrim & Blenko glass • Architectural accents
  - Lamps • Pillows & Bell pulls • Jewelry • Christmas ornaments, cards & wrappings • Candles • Boyd collectibles • Unique gifts & Home decor
- Extended holiday hours

**Traditions**  
Ltd.

120 N. Center • Northville  
(810) 349-0199

# A Christmas Tradition

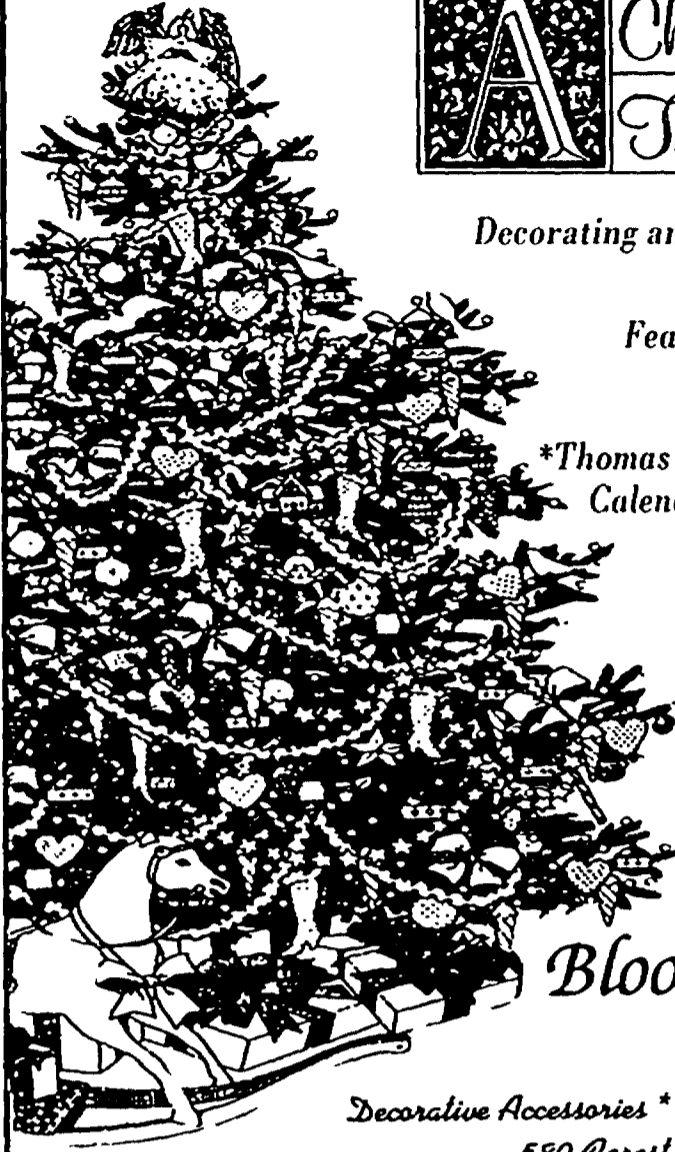

Decorating and gift-giving made special

\*Christmas Florals  
Featuring Preserved Greenery

\*Christmas Pottery

\*Thomas Kinkade Christmas Cards,  
Calendars, Notecards and Books

\*Pine Baroness Collectible  
Angels and Dolls

\*Dried Florals with  
the Look and Fragrance  
of Fresh Flowers

\*Decorative Accessories in  
Brass, Pewter and Tin

## Bloomsbury Lane

Decorative Accessories \* Gifts \* Dried Floral Designs  
580 Forest Ave. \* Plymouth

459-5566

ls21383

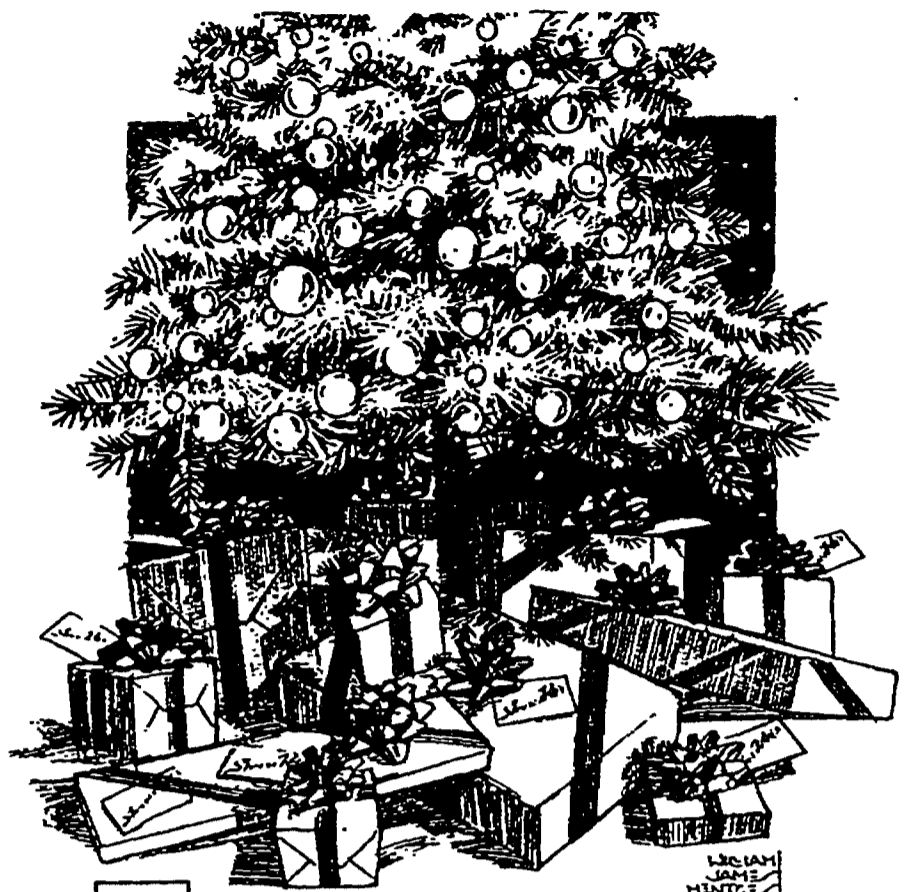

**T** "was the night before Christmas  
and under the tree  
there were gifts from Steve Petix  
from you to me.  
Merry Christmas and Happy New Year!

340 S. Main,  
Plymouth

### STEVE PETIX

CLOTHIER

(313)459-6972

21187

**Maggie & Me**

**Thanksgiving Sale**

**FRIDAY & SATURDAY**

NOV. 29th      NOV. 30th  
10-8              10-6

The Royal Oak Store Will be Open till 6 pm on Nov. 29th

**20% OFF EVERYTHING**  
EXCLUDING JEWELRY

PLYMOUTH  
924 W. Ann Arbor Trail  
ROYAL OAK  
325 S. Washington

**Holiday Open House**

*Piccadilly's*

House And Garden

We invite you to  
come and enjoy the  
warmth of the season.  
From our house  
to yours.  
Happy  
Holidays!

- Elegant gifts & accessories
- Holiday centerpieces & shags
- Unique ornaments
- Holiday Linens
- Ribbons, Tassels & Bows

Holiday decorating  
available

873 N. Mill Street • Plymouth • In Historic Old Village (313) 454-9220

Your HEALTH Stop for the Whole Family

# Zerbo's Health Foods

NOVEMBER/DECEMBER  
Zerbo's  
**RED APPLE VITAMIN LINE**  
Buy 1 Bottle at Regular Price  
Get the Second Bottle of Equal or Less Value for **1/2 OFF!**



VITAMINS • HEALTH FOODS • BOOKS  
• FRAGRANCES • COSMETICS

34164 Plymouth Rd. • Livonia (313) 427-3144

"no bones about it"

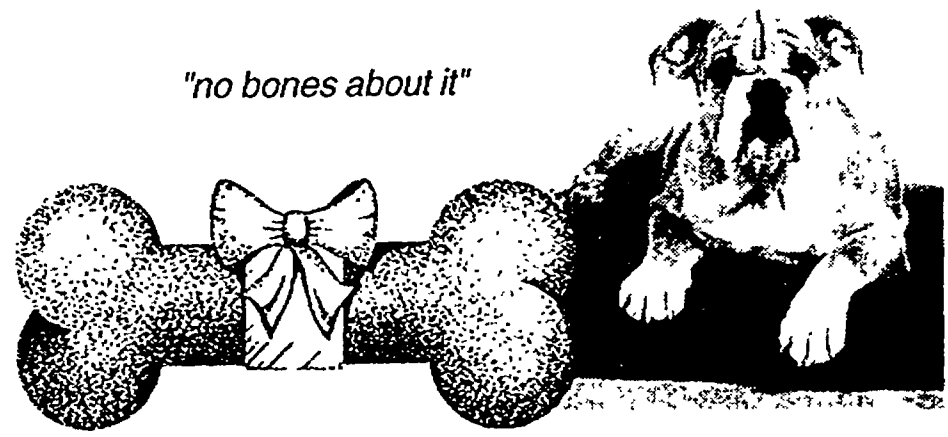

## The Perfect Pet-Lover's Present

This holiday, give a really special gift to the pet lover on your list. Jill Andra Young Photography, this area's leading pet photographer, is now offering gift certificates along with a special treat package just in time for Christmas

For a limited time, along with each gift certificate purchased, you will receive a selection of Iams Pet Food products and promotional items for that special pet and pet lover. Boxes of Iams biscuits, biscuit canisters, flashlight keychains, discount coupons, and even Iams pet bandanas; all this free stuff adding up to make this a really special present for both pet and owner!

Our gift certificates start at just \$48.00 for a studio sitting of a pet. You can select one that also includes individual prints or packages, tailored to your needs or budget. And remember, the gift of photography creates memories that will be cherished for a lifetime, long after the warm glow of the holiday fades.

**Actually, there are bones, too!!!**

To make this a really tasty deal, we have teamed up with another well-respected name in the pet world, Iams Pet Foods

If you need more information or would like to purchase a gift certificate, feel free to call or stop in our studio in downtown Plymouth.

**Jill Andra Young Photography** 825 Penniman Plymouth, Michigan 48170 (313) 455-7787

©1996 JAYP

# Quilt Works

**Christmas Gifts for the Quilter Gift Certificates Available**

Let our friendly and knowledgeable staff assist you.

580 Forest  
Plymouth, Michigan 48170  
(313) 207-8708

Store Hours:  
Mon.-Sat. 10:00 a.m. to 5:00 p.m.



# LIGHTWEIGHT POWERHOUSE.



**WEIGHS ONLY 38 POUNDS. THROWS SNOW 25 FEET.**

**Promotion Price \$389.95**

**TORO® CCR POWERLITE® SNOWTHROWER**

- Exclusive Power Curve® rotor system cleans down to the pavement
- 3 hp engine
- 16" clearing width
- Folding handle for easy, compact storage

No Payments 'Til April 1, 1997 to Qualified Customers

**SAXTONS GARDEN CENTER**  
587 W. Ann Arbor Trail • Plymouth 453-6250  
Hours: Mon. 9-7, Tues.-Fri. 9-6, Sat. 9-4

**When you want it done right.**  
LAY-A-WAY AVAILABLE

# Holiday glow.

Send the FTD® Holiday Celebrations™ Bouquet.

A traditional holiday arrangement with a red votive candle will brighten any celebration and add just the right touch of festive cheer.

**From \$42.95**



**SATISFACTION GUARANTEED**

**Heide's** flowers & gifts

**24-HOUR ORDERING SERVICE**

995 W. Ann Arbor Trail • Plymouth, MI 48170  
(313) 453-5140 • (800) 831-7692  
Fax (313) 453-0633

©A Registered Trademark of Florists' Transworld Delivery, Inc. ®A Trademark of Florists' Transworld Delivery, Inc. ©1996 Florists' Transworld Delivery, Inc.



39500 Five Mile Rd.  
Plymouth, MI 48170

**GOLF DOME  
NOW OPEN  
7 DAYS!**

**9 a.m. - 9 p.m.**

**FREE  
GIFT!**

With Purchase of  
Gift Certificate  
For \$50 or VIP Book

Must present this ad.  
Offer expires 12-24-96  
or while supplies last

(313) **420-4653**

**EXTENDED HOURS  
NOW IN EFFECT  
AT THE MOST  
UNIQUE TOY &  
GIFT STORE**

- BRIO • Safari
- Breyer • Gund
- Playmobil • Applause •
- Darda • Tomy
- Thomas Tank
- Ravensburger
- Geo Safari

Wood Board Games,  
3D & Other Puzzles  
Unique, Unusual and Educational  
Toys & Games For All Ages

**Ultimate  
TOYS & GIFTS**

107 N. Center St., Northville.  
Hours Mon.-Fri. 10:00am - 8:00pm  
Sat. 10:00 am - 6:00 pm, Sun 12:00 pm - 4:00pm  
(810) 305-9990

Watch for Weekly  
Discount Specials  
Throughout the  
Holiday Season

**Showerman's  
Fine Wine & LIQUOR**

15333 Merriman at 5 Mile  
(313) 427-0903



One of the largest selections and stock of liquor,  
imported beer and wine in the country.  
We specialize in wedding and party catering.  
Fax (313) 427-0933



Fine  
Wine &  
Liquor

19213 Newburgh at 7 Mile

(313) 462-1144

Deli, Party Trays, Gift Baskets

**SUTTER  
HOME**  
White Zinfandel  
**2/\$8.00**  
750 ml

**FINE  
CIGARS**  
Macanudo,  
Te-Amo  
& More!

**DOM  
PERIGNON**  
**\$84.95**  
With Coupon  
Expires 12-31-96

**FORTANT  
De FRANCE**  
Cabernet, Chardonnay  
& Merlot 750 ml  
**2/\$12**

**GIFT  
BASKETS  
STARTING  
AT  
\$16.99**

**KORBEL  
CHAMPAGNE**  
Brut, Extra Dru  
& Blanc de Neirs  
**\$8.99**  
750 ml

**CARMEN**  
Merlot, Cabernet,  
Chardonnay  
**2/\$11.00**  
750 ml



**LINDEMAN'S**  
Chardonnay,  
Cabernet, Shiraz  
**\$6.99**  
750 ml  
\$12.00 mail in rebate per case  
of any white wine

**GIFT BASKETS FOR THE HOLIDAYS**

**LOUIS  
JADOT**  
Beaujolais Villages  
**\$8.99**  
Pouilly Fuisse  
**\$19.99**



**MARTINI &  
ROSSI ASTI**  
**\$7.99**  
**-\$3.00** mail in  
rebate  
**\$4.99** 750 ml

**CARLO  
ROSSI**  
**\$7.99**  
4 litre

**STOCK  
VERMOUTH**  
Sweet & Dry  
**2/\$8.00**  
750 ml

**HEINEKEN &  
AMSTEL LIGHT**  
12 Pack  
Bottles  
**\$10.99**  
plus tax & dep.

**TAITTINGER  
BRUT  
LA FRANCAISE**  
**\$24.99**  
With Coupon  
Expires 12-31-96

**CORPORATE  
ACCOUNTS  
WELCOME!**

**LABATTS**  
24 Packs  
Cans  
**\$13.99**  
plus tax & dep.

We CATER To Your  
**HOLIDAY  
PARTY  
NEEDS!**

**Hot Food Catering from..... \$6.99** (per person)  
Select one of ours or create your own. 20 person minimum

**Deluxe Party Tray..... \$4.25** (per person)  
4 Meats, 3 Cheese, Salad, Bread & Relish Tray

**Vegetable Trays from..... \$26.95** (20 people)

**6 Ft. Sub..... \$42.99**  
3 Meats, 2 Cheeses plus All The Trimmings

Also, ask about our  
**People Pleaser Subs!**

**SUNDAY CATERING AVAILABLE**

**Joe's**  
**ITALIAN BAKERY AND DELI 416-1456**  
1058 W. Ann Arbor Road • Plymouth • Across from Sunshine Honda  
Open Daily 9-7; Saturdays 9-6; Closed Sundays

**10% OFF ALL  
CASES OF WINE!**  
excluding sale items





**SAVE! UP TO** *Holiday Sale!*  
NOW THRU DEC. 23, RD 1996

**50% OFF!** ALL MENS FASHIONS  
**CORPORATE CASUAL & DRESS**

UNIQUE SUITS - SPORT-COATS - SLACKS - SHIRTS - SWEATERS - PULLOVERS - TIES - SHOES - LEATHERS & MORE!  
**FINEST ITALIAN & AMERICAN DESIGNERS LINES**

- ZANETTI • RISCATTO • GEORGIO BRUTINNI
- TALLIA • RAFFI • JOHNSTON & MURPHY
- AXIS • TUNDRA • HART SHAFNER/MARX
- CLINE • PEERLESS • CARLO ALBERTO & MORE

**MILANO**  
GENTLEMEN'S FINE APPAREL

882 ANN ARBOR TRAIL (Downtown Plymouth) - West of the Mayflower Hotel -  
**PHONE: 313-453-0790**  
HOURS: Mon.-Thur. (10am-8pm) Fri.(10am-9) Sat.(10am-6pm)

**PRECISION CUSTOM TAILORING FOR MEN & WOMEN**

**PARKWAY PROFESSIONAL GROOMING**  
WE OFFER ALL BREED DOG GROOMING



- SPECIALISTS IN -  
**BICHON FRISE & SHIH-TZU**

*Don't Forget Your Best Friends at Christmas*

Every Pet Groomed In December receives a free Christmas Gift.

Visit Our Beautiful New Home at  
418 N. Main Street, Plymouth  
Between Starkweather & Lilley  
Linda M. Lewis, Owner  
Gift Certificates Available

**We Are Your Pet Care Specialists**  
**(313) 453-9488**  
Mon.-Sat. 9 to 5 For Your Appointment Call Established In 1985

**BEARLY WORN CONSIGNMENTS**



**NEED EXTRA CASH FOR THE HOLIDAYS?**

Bring in your "Like-New" (two years or newer) toys (Fisher Price, Little Tikes, etc.), ladies & children's winter & holiday wear, maternity & baby equipment.

*Ask about our CASH/CONSIGN OPTION.*

Monday - Friday 10-6  
Saturday 10-5; Sunday 12-5

294 S. Main — Plymouth  
**(313) 416-9417**

Wrap up your Holiday Gift List with...

*Sanders* since 1875 ... a holiday tradition since 1875

Sanders fine quality Chocolates and Toppings are a perfect fit for everyone on your LIST.

from our... Old Fashioned Family Assortment to our Honeycomb Chips ... always a favorite!

or perhaps... one of Sanders Fancy Fruits or our world famous Milk Chocolate Hot Fudge Dessert Topping.

Remember... MAIL ORDER sending Sanders for the holidays ... says it best!

For information ... on mailing these out of town gifts or to find a store featuring Sanders products... near you

call 1-800-651-7263 or 1-810-776-7447 office - Novi, MI 48375

*Holiday List*

- ...for the house
- ...co-workers
- ...clients
- ...Teachers
- ...Family
- ...out of town relatives...
- ... Aunt Mary in
- ... Uncle Tony in
- ... Tom & Chris
- ...etc.
- ...etc.
- ...etc.

**Stan's market**

*For all your Holiday Goodies!*

(All Natural) 10-25 Lb.  
**Fresh AMISH TURKEYS**

(Whole or Half's)  
Kowalski or Dearborn  
**SPIRAL SLICED HAMS**

Stan's Famous Homemade  
**Fresh KIELBASA**

5 Mile & Farmington • Livonia  
(313) **261-6565**  
38000 Ann Arbor Rd. • Livonia  
(313) **464-0330**



VISA MasterCard



**Canton  
Miami Moods Tanning**  
39463 Joy Rd. • Canton  
313-459-5650

- HOT BEDS!!
- FACIAL BED!!
- REGULAR BEDS!!

~NEW CUSTOMER SPECIAL~  
**\$1.00 First Visit**

**HO HO HO HOLIDAY SPECIALS!**

<b>2 WKS. UNLIMITED PKG.</b> \$15 <sup>00</sup> Reg. \$20 <sup>00</sup> Expires 12-31-96	<b>ONE MO. UNLIMITED PKG.</b> \$28 <sup>00</sup> Reg. \$35 <sup>00</sup> Expires 12-31-96	<b>BUY 1st PACKAGE GET 2nd PACKAGE ½ PRICE</b> Expires 12-31-96
--	---	--

**Gift Certificates Available  
Great Stocking Stuffers!  
Tanning Lotions & Sportswear**

## FALL FURNACE SPECIALS

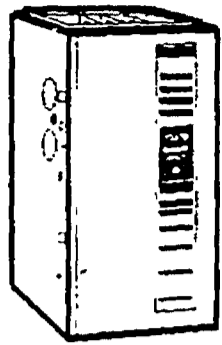
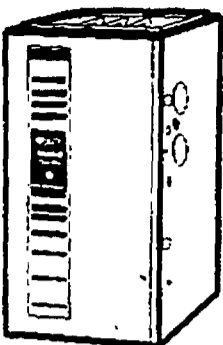
 COOLING Carrier LEADERSHIP DEALER	92% EFFICIENT Model #58MXA Installed from <b>\$2195</b>	80% EFFICIENT Model #58TUA Installed from <b>\$1595</b>	 HEATING Carrier LEADERSHIP DEALER
<b>COMMUNITY COMFORT SERVICE</b> INCORPORATED 8205 RONDA, CANTON 48187 <b>453-2230</b>			

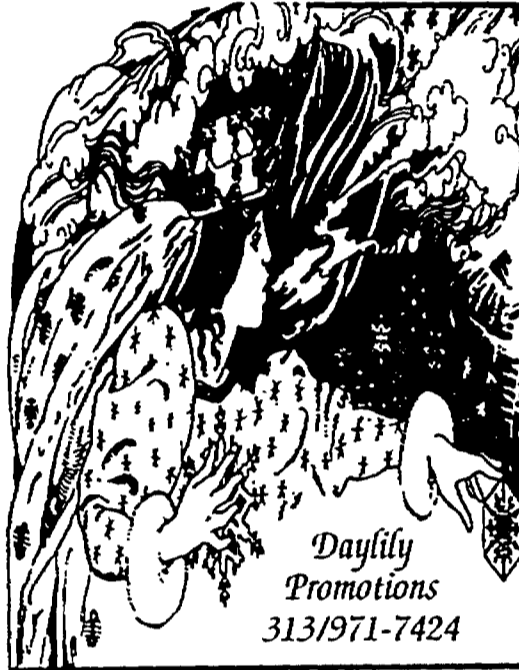

**Winter Magic  
Arts & Crafts**

December 7  
10am - 4pm  
Washtenaw  
Community  
College

Morris J. Lawrence Bldg  
Huron River Dr. at Golfside  
\$2 admission • Under 10 Free

Daylily  
Promotions  
313/971-7424

On the Internet: <http://daylilycrafts.com>



**Holiday shopping shouldn't  
make you want to SCREAM!**

Visit Art Source for personalized service on affordable art, framed & unframed ... prints & museum reproductions ... original photography ... custom mirrors ... art lover's note cards ... gift certificates ... the finest in custom framing

**ART SOURCE**  
AFFORDABLE ART • PICTURE FRAMING SPECIALISTS

126 MainCentre Building  
(Center Street, south of Main)  
Downtown Northville  
(810) 348-1213

**HOLIDAY HOURS** (beginning November 22)  
Monday thru Friday 10:00-8:00 Saturdays 10:00-6:00 Sundays Noon-4:00

## Holiday Special

 ONE TOUCH <b>ONE TOUCH TEST STRIPS</b> 100 ct. \$55 <sup>00</sup> (reg. \$60 <sup>00</sup> )
 <b>SURE-STEP TEST STRIPS</b> 50 ct. \$33 <sup>00</sup> (reg. \$37 <sup>00</sup> ) Limit 2 With Coupon • Expires 12-24-96

We Carry all supplies for your Diabetic Needs

**doi** 11587 Farmington Rd. Hours:  
 diabetic specialties, inc. Livonia 1-313-425-0010  
 M-TH 9:30 - 7 p.m.  
 FRI. - 9:30 - 6 p.m.  
 SAT - 9:30 - 2 p.m.

*Creative Framing & Gallery*

Large Selection of FRAMES & MATS  
• FRAMED PRINTS • POSTERS • LIMITED EDITIONS

**20% Off FRAMED CHRISTMAS PICTURES**

15% Off NOVEMBER 16 THROUGH DECEMBER 15  
10% Off DECEMBER 16 THROUGH DECEMBER 31  
*(on incoming orders only)*

853 West Ann Arbor Trail • Plymouth  
(1/2 Block West of Main Street) (313)453-2810



**WHERE SANTA SHOPS for ALL HIS:**

Soaps, Lotions, Gels, Bubble Baths, Candles and More...  
 Gift Baskets and Shipping also available

*Come in for your FREE Frequent Bather Card*

**NATURALLY**  
 HOME & BATH ESSENTIALS  
 550 Forest Avenue  
 DOWN TOWN PLYMOUTH  
 (313) 453-9491

Emily's World  TRAVEL LTD.

**"We Want To Be Your Travel Agent"**

- Airline Tickets • Tours • Rail
- Cruise Discounts



NO SERVICE CHARGE

TRAVEL GIFT CERTIFICATES AVAILABLE

**455-5744**

708 S. Main St.  
 Plymouth

**Quicksilver Photo**

**\$69.99\*** Black & White  
**Photo Restoration**



*Makes an excellent Holiday Surprise!*

Color Restoration **\$99.99\***  
\*Some images that require extensive restoration may cost more.

Restore ripped, stained and faded memories with the latest in Graphics Technology

Tis' the season for <b>Holiday Cards</b>	50 Cards* 5x7	Price \$45.00
	5x5½	\$40.00

Your favorite pictures set to a holiday format available in 5x5½ and 5x7 - envelopes included.



\*Other Quantities Available

**Quicksilver Photo**  
 1150 W. Ann Arbor Rd.  
 (313) 455-3686



**Your fireplace Headquarters!**

Holiday Warmth  
**GAS LOGS**  
 As Low **\$129<sup>95</sup>**  
 As 24"





**TOWN 'N COUNTRY**  
 HARDWARE and FIREPLACE

3 1/2 blocks west of Inkster Rd.  
 GARDEN CITY  
**27740 FORD ROAD**  
 Open 9 to 8 pm Monday thru Friday  
 9 to 6 pm Saturday • Closed Sundays

**GLASS FIREPLACE DOORS**  
 Custom Designed and build for your individual fireplace

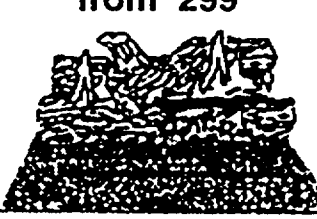
18" Ventless GAS LOGS from \$299<sup>95</sup>



Glass Doors Polished Brass from \$99<sup>95</sup>

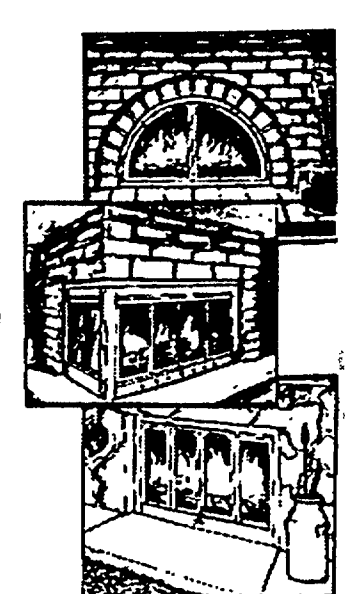

**FIREPLACE TOOLS**  
 Over 100 to Choose from  
 Save 20% - 30%  
 Starting At **\$19<sup>95</sup>**  
 to **\$199<sup>95</sup>**

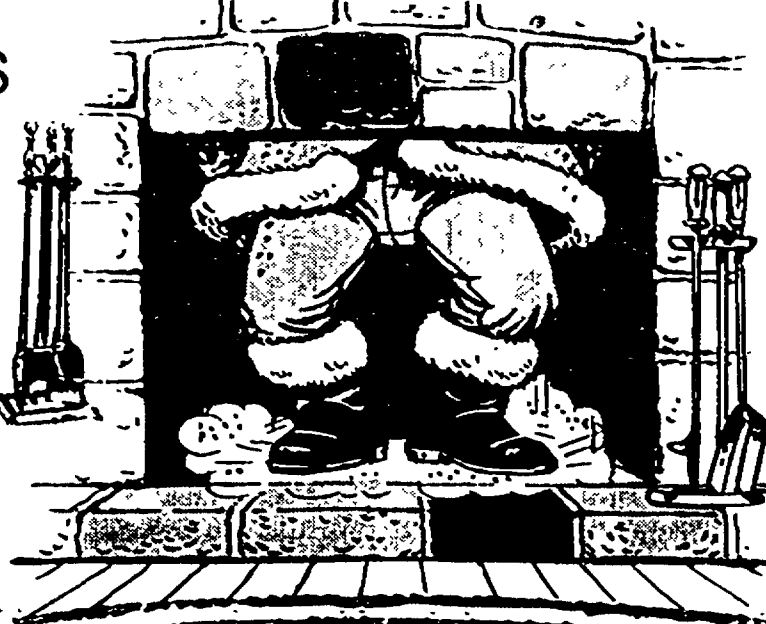

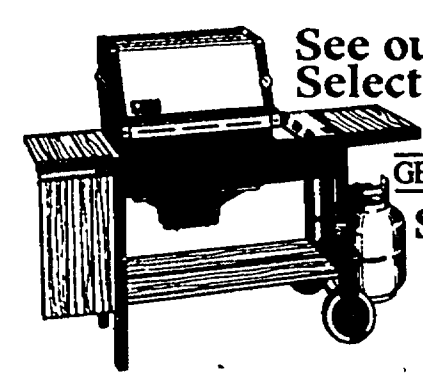

**GAS GRILLS**  
 See our complete Selection of

**GENESIS GAS BARBEQUE**  
 Starting As Low As **\$369<sup>95</sup>**

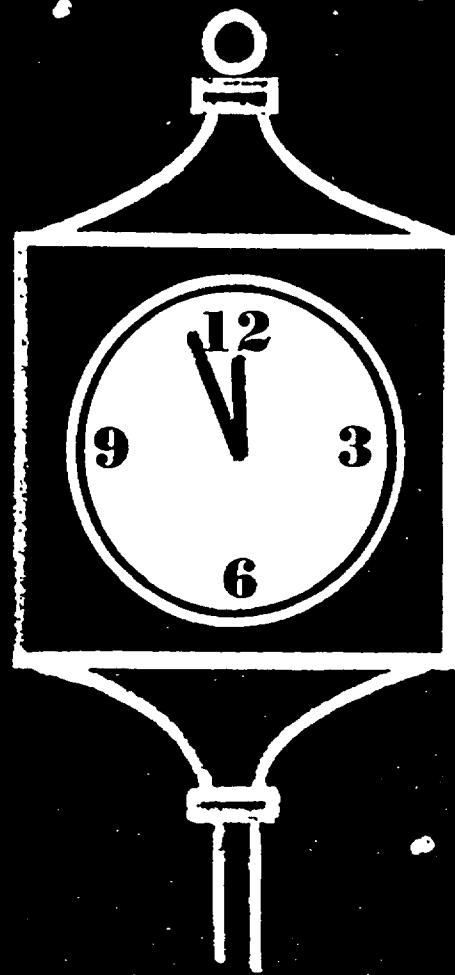

# "MIRACLE ON MAIN STREET" DOWNTOWN NORTHVILLE



\* Vintage village atmosphere

\* One-of-a-kind shops & restaurants

\* Lots of FREE parking

Look for this sign

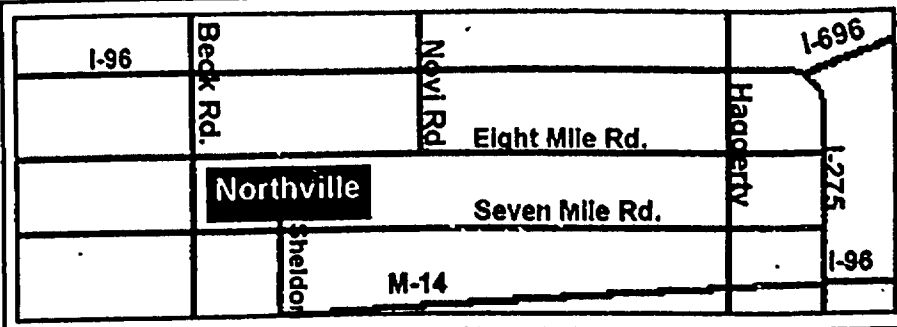

### Special Events

- \* "MIRACLE ON MAIN STREET" PARADE - Friday evening, 11/22, 6:00. After the parade, until 9:00, visit Santa and his reindeer at Santa's House, by the Gazebo.
- \* CHRISTMAS WALK - Sunday afternoon, 11/24, 1:00 - 5:00
- \* CANDLELIGHT WALK - Friday evening, 12/6, 6:00 - 9:00
- \* CHARITY AUCTION - Sunday afternoon, 12/8, 1:30 - 3:00
- \* VISITS WITH SANTA - (Call for hours)

### MIRACLE MERCHANT HOLIDAY HOURS

Monday-Friday 10:00-8:00, Saturday 10:00-5:00, Sunday 12:00-4:00

NORTHVILLE CENTRAL BUSINESS ASSOCIATION, (810) 349-0522 or (810) 348-1213

# GRAND OPENING

R  
A  
N  
D  
O  
P  
E  
N  
I  
N  
G

R  
A  
N  
D  
O  
P  
E  
N  
I  
N  
G

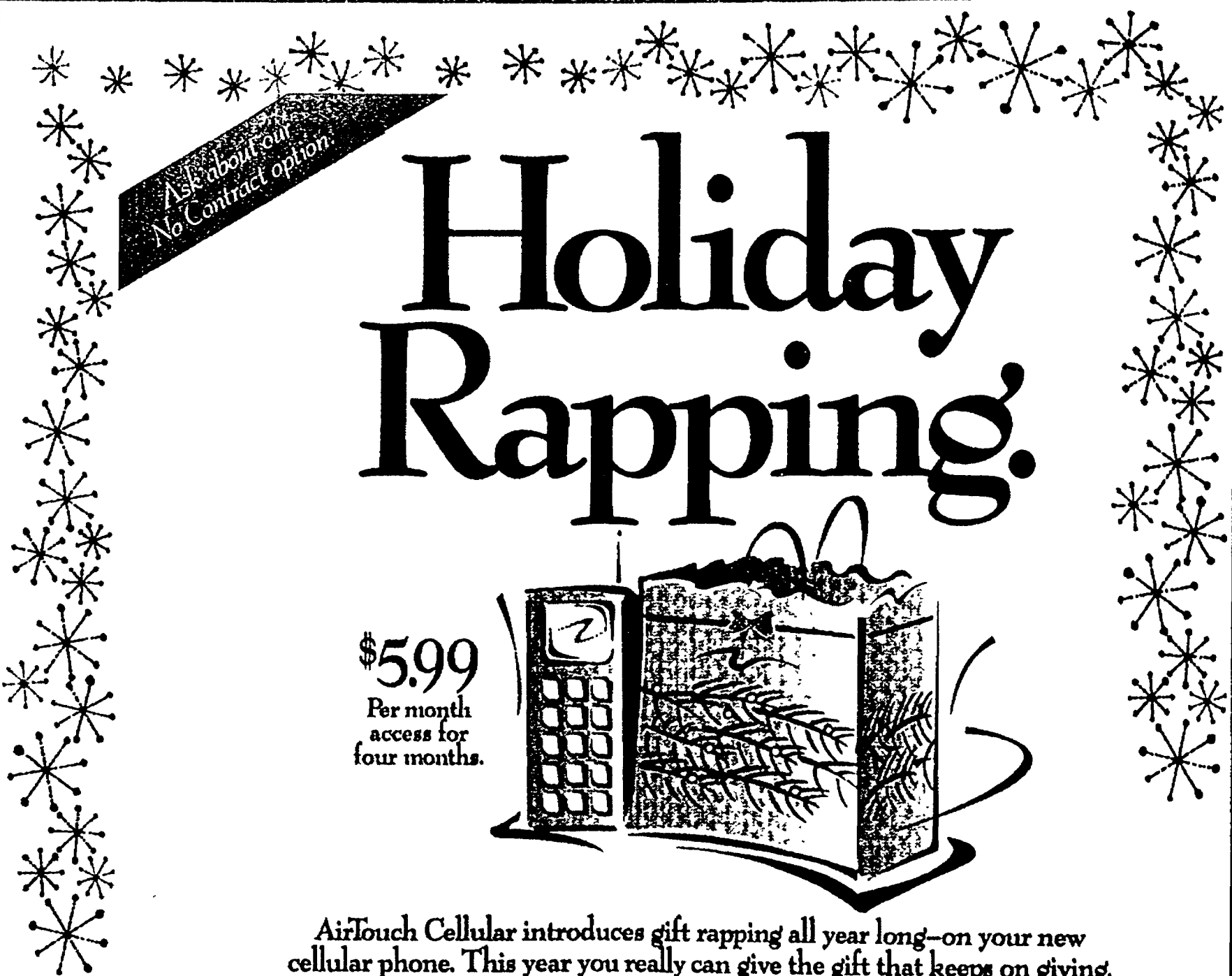

**\$5.99**  
Per month  
access for  
four months.

AirTouch Cellular introduces gift rapping all year long—on your new cellular phone. This year you really can give the gift that keeps on giving.



The AirTouch Cellular Holiday Gift Pack includes:

•FREE Phone with a two-year service agreement.

And, for the first four months:

- \$5.99 per month access fee.
- FREE 10 minutes of airtime per month.
- FREE Unlimited Weekend Calling.

Authorized Agent for

**AIRTOUCH**  
Cellular

Formerly Cellular One

So stop by **The Cellular Store & More** and we'll rap about the Holiday Gift Pack.

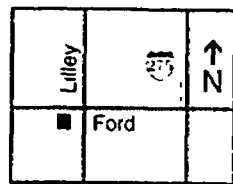

**CANTON**  
42695 FORD ROAD  
IN CANTON CORNERS  
NEAR THE OUTBACK  
STEAK HOUSE  
313-981-7440

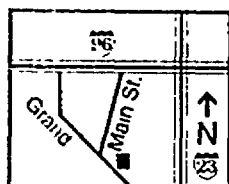

**BRIGHTON**  
455 E. GRAND RIVER  
1/4 MILE EAST OF  
MAIN STREET  
ACROSS FROM LUCK DUCK NURSERY  
810-227-7440



**THE CELLULAR STORE & MORE**  
**1-800-CELL-MORE**

Mon • Wed 10-6 • Thurs • Fri. 10-8 • Sat 10-6

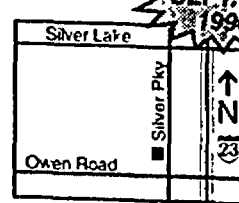

**FENTON**  
18010 SILVER PARKWAY  
IN SILVER LAKE VILLAGE  
ACROSS FROM KMART  
810-629-7440

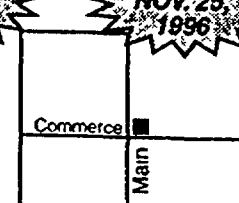

**MILFORD**  
101 E. COMMERCE  
N.E. CORNER OF  
MAIN & COMMERCE  
810-684-7440

New activations only. Limited to certain rate plans. Not valid with any other discounts or credits. Free airtime minutes limited to calls originating from your Home market for four months and begin on second bill. Unlimited minutes will be forfeited. Roaming toll long distance and taxes extra. Free Unlimited Weekend Calling feature begins on second bill and includes off-peak hours from Saturday morning through Sunday evening for four months. This feature will continue as a \$9.99 monthly charge after four months until customer cancels. AirTouch Cellular bills in one month increments. Customer will be responsible for payment of the full month access fee for the month in which service is cancelled. Other usage charges. Other restrictions apply. Offer ends December 31, 1996. AirTouch and the AirTouch logo are trademarks of AirTouch Communications, Inc.

# GRAND OPENING

# The Holiday Stars

*Savings That Sparkle All Season*



Diamond baguette heart pendant

**\$399**

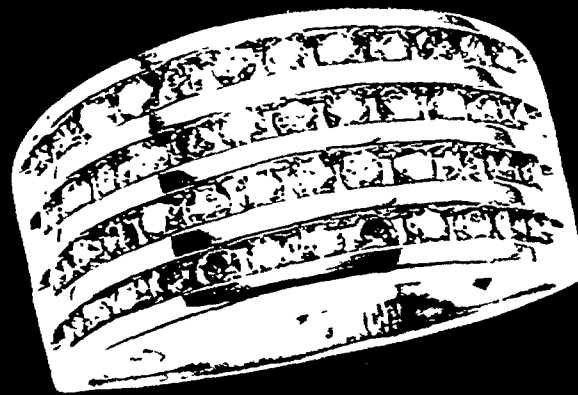

Elegant channel set diamond anniversary band  
1 CT TW

**SPECIAL VALUE**  
**\$299**

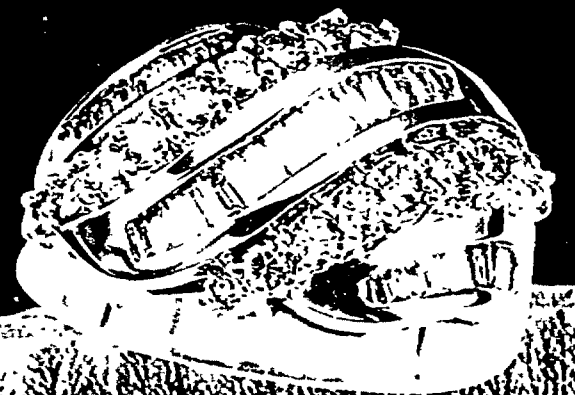

Round and baguette diamond anniversary ring  
1 CT TW

**\$999**

Diamond baguette anniversary ring

**\$899**

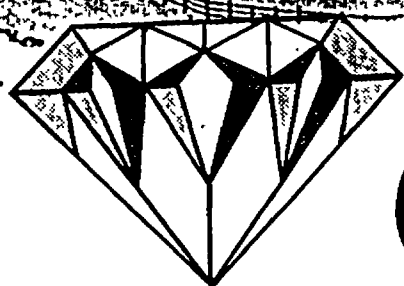

**JEWEL GALLERY**

# Astonishingly Affordable Diamonds Just In Time For The Holidays

## Christmas Specials!

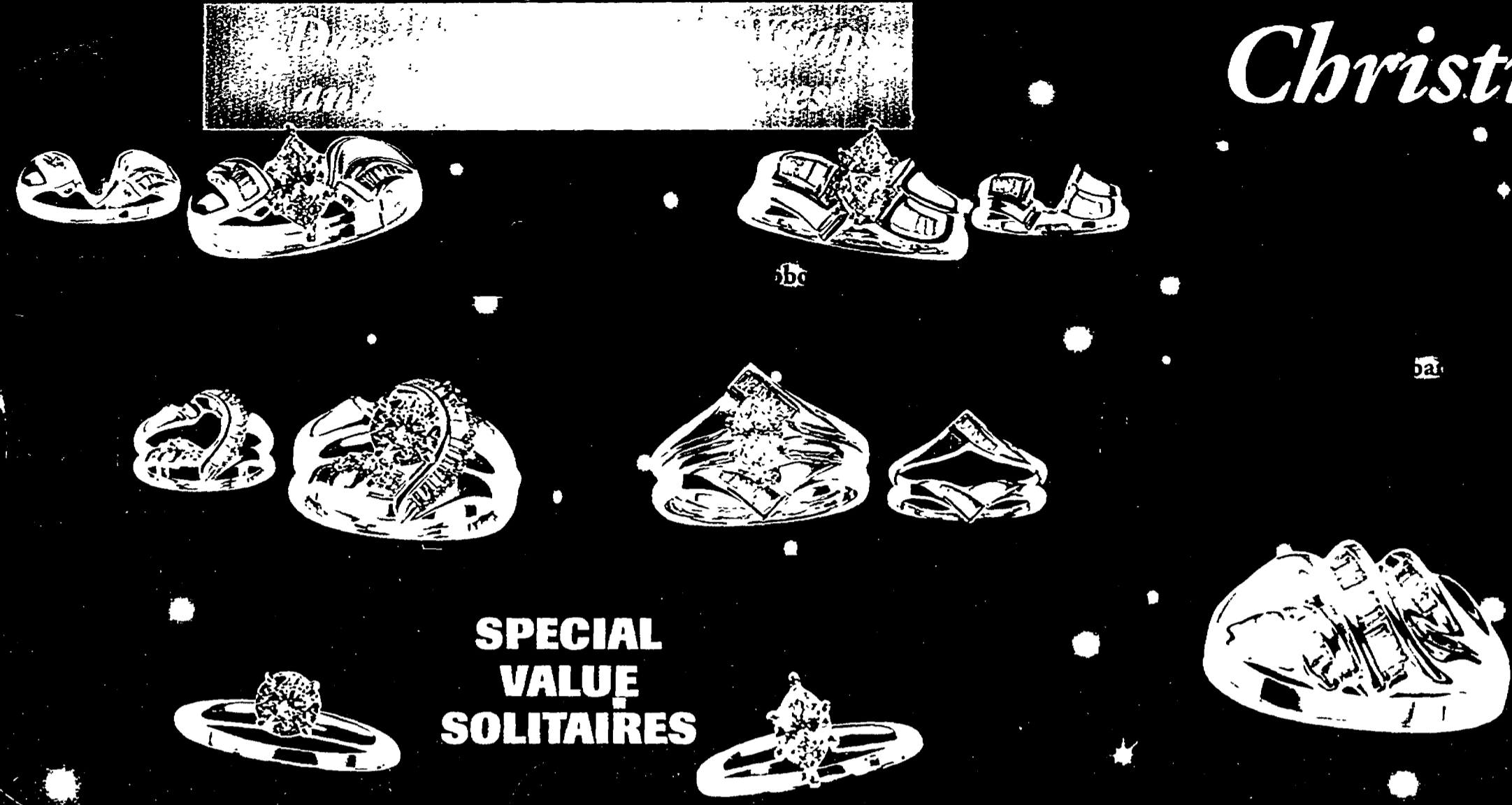

**SPECIAL  
VALUE  
SOLITAIRES**



EARRINGS		PENDANTS	
1/10 CT TW	<b>\$79</b>	1/10 CT TW	<b>\$89</b>
1/4 CT TW	<b>\$149</b>	1/4 CT TW	<b>\$249</b>
1/2 CT TW	<b>\$399</b>	1/2 CT TW	<b>\$599</b>
1 CT TW	<b>\$999</b>	1 CT TW	<b>\$1999</b>

**AS  
LOW AS**

**AS LOW AS**

**From  
\$169**

**'Hugs and kisses'  
diamond bracelet  
1 1/2 CT TW **\$149**  
1 CT TW **\$249**  
1/2 CT TW **\$349****

**Fashion diamond bracelet  
1 CT TW **\$499****

**'S' bar diamond tennis bracelet  
2 CT TW **\$699**  
3 CT TW **\$899****

**Oval pave with diamonds  
\$299**

**Traditional styled  
cluster diamond ring  
\$399**

\*10 KT Gold

\*10 KT Gold

ALL TOTAL WEIGHTS ARE APPROXIMATE .1CT=.95 TO 1.10

ALL TOTAL WEIGHTS ARE APPROXIMATE .1CT=.95 TO 1.10

100% SATISFACTION GUARANTEE

100% SATISFACTION GUARANTEE

YOUR CHOICE



YOUR CHOICE



YOUR CHOICE

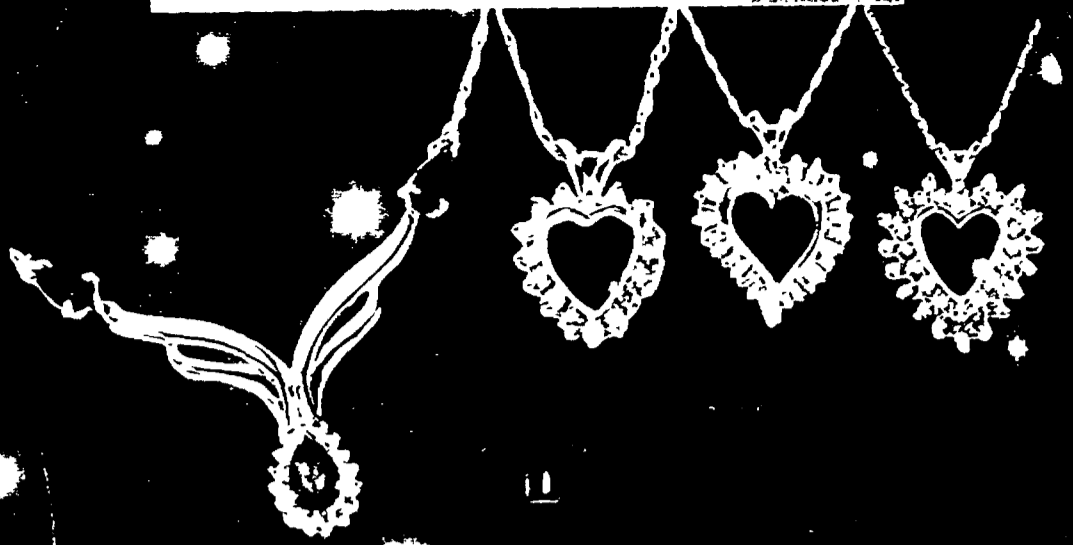

YOUR CHOICE



YOUR CHOICE



YOUR CHOICE

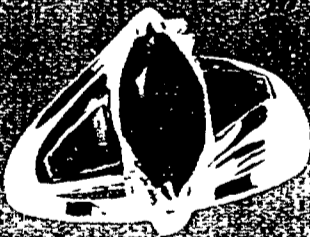

More Great Holiday Values!

1/10 CT TW \$169  
1/4 CT TW \$249  
1/2 CT TW \$349  
1 CT TW \$499

1/4 CT TW channel set anniversary band. Unbelievable Value \$99

60 Traditional diamond band 1/2 CT TW \$449

AS LOW AS \$99

JEWELRY ENLARGED TO SHOW BEAUTY OF DETAIL. CT MEANS CARAT WEIGHT. TW MEANS TOTAL DIAMOND WEIGHT. ALL TOTAL WEIGHTS ARE APPROXIMATE. 1CT= 95 TO 110. WE ARE NOT RESPONSIBLE FOR TYPOGRAPHICAL OR PHOTOGRAPHIC ERRORS. SOME ITEMS NOT IN STOCK ARE AVAILABLE BY SPECIAL ORDER. DUE TO THE FLUCTUATION OF THE GOLD MARKET, PRICES ARE SUBJECT TO CHANGE WITHOUT NOTICE. ALL OUR STYLES COPYRIGHTED.

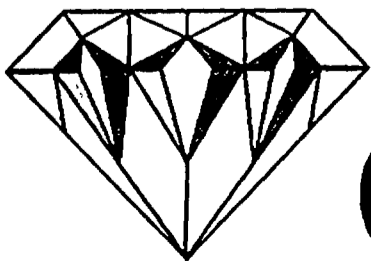

JEWEL GALLERY

Livonia Mall  
29528 West Seven Mile Road  
Livonia, Michigan 48152  
(810) 471-5007







**THANKSGIVING  
SPECTACULAR!**

**Billy Bob's**  
GAMEROOM FURNISHINGS  
Your Leader in Fun & Functional Furniture!



**\$898**

79" 2 Piece  
Traditional  
Oak Wall

- Holds 32" big screen
- Lighted display areas
- Beveled brass and glass doors
- Vertical tape storage



**SPECIAL HOURS**

Friday	9 am-10 pm
Saturday	10 am-10 pm
Sunday	11 am-6 pm
Monday	10 am-9 pm
Tuesday	10 am-9 pm

**SPECIAL HOURS**

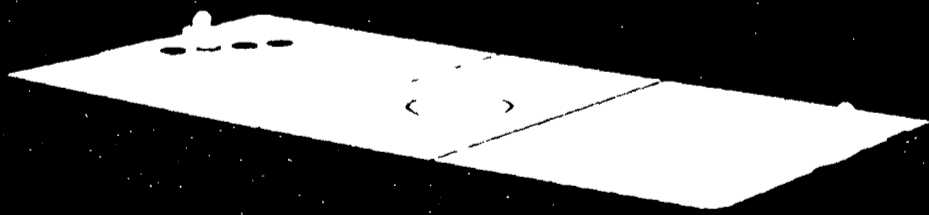

ESCALADE  
SPORTS

★ Made in the USA ★

7' air hockey  
SALE \$498  
NOW ONLY  
**\$448**

with  
instant  
rebate  
\$50

7' Table Hockey

- Granite laminate
- 7' foot playing surface
- Powerful 8 amp motor for constant air flow
- Steel reinforced legs
- Includes dial-a-score and all playing equipment

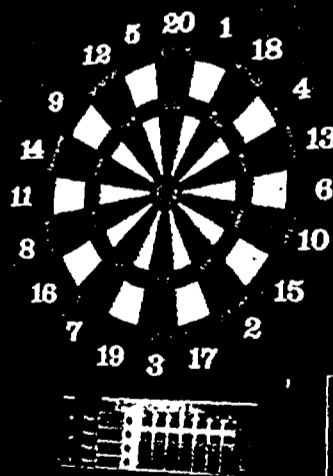

Pro Challenger II  
Electronic Dart Board

- Plays 21 games including cricket
- 4 player cricket
- Made in the U.S.A
- Price guarantee
- 3 year warranty

Pro Challenger  
**\$288**

**6**

**MONTHS  
SAME AS  
CASH\***

**N**

- ✓ DOWN PAYMENT
- ✓ INTEREST
- ✓ PAYMENTS



\*Using the Billy Bob's card with approved credit when you pay for same as cash purchase within a 180 day period. All previous sales excluded. See store for details. Normal APR 20.25%

# HOME-OFFICE GALLERY

CREATE YOUR OWN BOSS-FREE ENVIRONMENT IN OUR



**\$898**

72" 2 pc. set

## 72" Super Desk & CD-Rom Hutch

Has room for all of your home computer goodies with lots of great features like oversized keyboard and mouse roll out, laser printer storage, tower storage, locking door storage plus more!!



**\$598**

2 pcs.: desk & hutch

## Power-up Your CD-ROM Station

60" desk and hutch offer function and versatility - 17" monitors fit here! A lot of storage for all your stuff in letter/legal file drawer. Room for mouse and keyboard. Store 50 CDs in hutch racks.

All Products  
Featured are  
Factory  
Assembled!

Factory assembled real oak 48" deluxe printer work station.

Two piece set includes CD-ROM hutch with disc storage, bulletin board, desk with roll out keyboard tray, pencil drawer and roll out laser-ready printer tray.

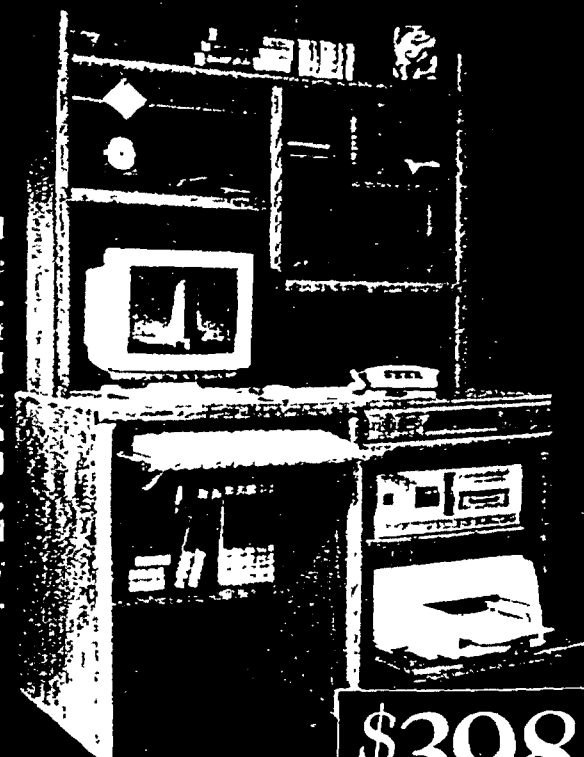

**\$398**

2 pc. group

**\$898**

4 pc. set

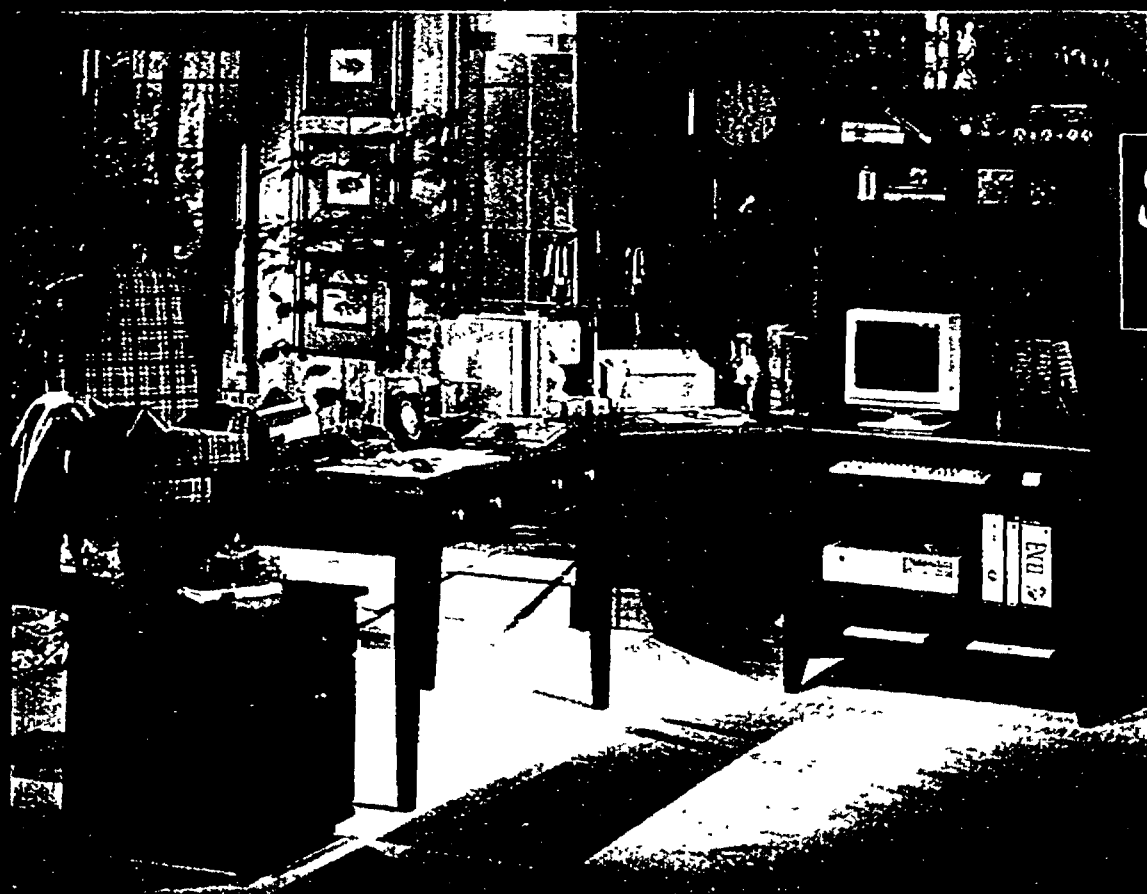

"Hearthside Traditions" Home Office Computer Workcenter

## 4 Piece Computer Work Center

Set includes organizer hutch, computer center, corner desk and work table desk all constructed of North American hardwoods finished in a rich hunter green and honey maple combination. Rolling file cabinet also in stock \$198.00.

R

## Real Oak Extra Wide

## Extra Deep Bookcases

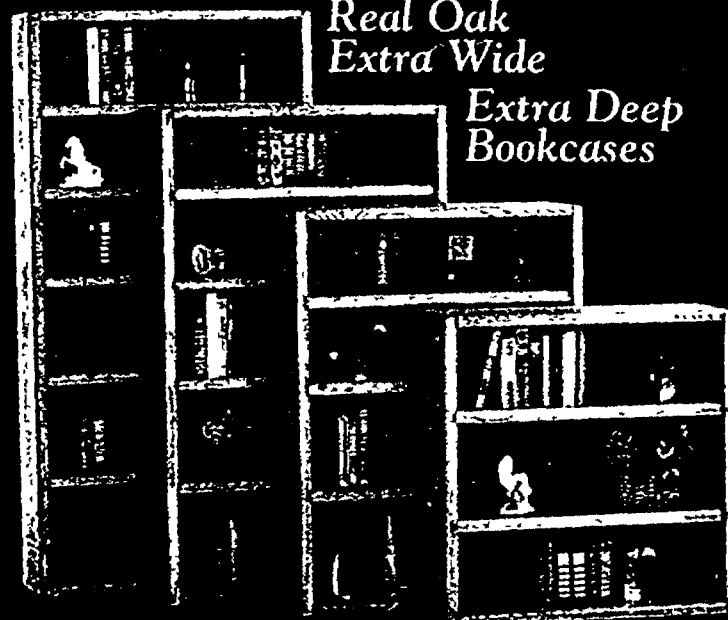

30"	.....	\$98.00
36"	.....	\$128.00
48"	.....	\$158.00
60"	.....	\$188.00
72"	.....	\$218.00
84"	.....	\$248.00

GAMEROOM *Party* FURNISHINGS

Your Leader in Fun & Functional Furniture!

**\$798**

3 pc. corner desk

3 pc. hutch set . . . \$498.00

### Ultimate Corner Computer Center

Features include locking storage doors, book shelves, diskette storage, oversized mouse keyboard roll out tray, lower storage shelf, two box letter drawers, legal size file drawer, documentation storage, fluorescent light, CD-ROM speaker shelves, CD storage rack, built-in surge protector, tower storage and roll out printer tray.



Unheard of value on this "real oak," factory assembled 4 piece corner group. Includes oversized roll out keyboard/mouse tray, CD-ROM hutch with disc storage and bulletin board, lower level bookshelf and deluxe printer stand with corner unit

**\$348**

2 pc. group



### Desk and Return

Features 60" desk with legal size file drawer, letter drawer, pencil drawer, 54" printer return, large roll out and disc drawer roll out for laser printer.



GAMEROOM FURNISHINGS

Your Leader in Fun & Functional Furniture!

**\$548**

2 pc. desk & printer return

## GREAT DESK CHAIRS!

**\$148**



- Gas lift
- Adjustable arms
- Oak finish base

**\$88**

- Fully adjustable
- Oak finish arms and base

- Gas lift
- Fully adjustable

**\$98**

22" solid brass

**\$88**

In choice of colors

24" solid brass

**\$98**

Desk lamp in choice of colors

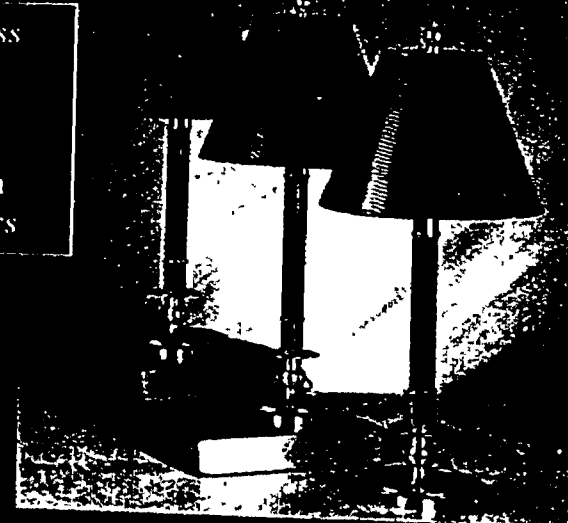

# HOME ENTERTAINMENT & HOME THEATER FURNITURE

**ALL** holiday sale priced! **ALL** in stock!



**\$498**  
AV center

**Kenwood's Traditional AV Center**  
Holds 27" TV, features tape storage drawer, oak and brass door conceal your audio components.

**\$498**  
AV center

**\$2198**  
3 pc. oak wall

**Washed Pine Entertainment Center**

- Holds 32" big screen
- Double glass audio doors
- Concealed tape storage
- 61" wide x 22" deep x 50" high
- In stock for immediate delivery!



**California Contemporary 3 Pc. Entertainment Wall**

California contemporary oak wall features solid oak construction pocket doors to conceal your 32" big screen. Built-in wire management system. And lots of tape and display storage. Corner wedges also available at \$348.00.

**\$1598**  
As shown

**\$998**  
Corner unit



**Traditional Oak Corner Unit**

Holds 32" TV, tape storage drawer, brass and glass doors enclose your audio components.



**Big Screen Expandable Wall**

- Rich golden oak
- Lighted display areas with dimmer
- Holds 222 CDs or 90 VHS tapes
- Expands to hold all big screens up to 60"
- Room for all your components
- Surround sound ready



**\$1298**  
3 pc. wall

**90" Monitor Size Wall System**

Our monitor size wall will hold all TVs up to 35" and has concealed tape storage for 180 CDs or 90 VHS tapes. Other features include solid oak tambour doors to enclose your TV when not in use, lighted display areas and plenty of door storage. Corner wedges are available for \$148.00 ea.

**BILLY BOB'S** has Metro Detroit's largest selection of in-stock HOME ENTERTAINMENT FURNITURE  
Factory Assembled in the USA at guaranteed lowest prices!

**\$298**  
TV stand

**Classic Cherry TV Stand**  
Holds 32" TV, on casters, pewter finished hardware, tape and audio component storage.



**Big Screen Expandable Wall**

- White washed oak
- Lighted display area with dimmer
- Vertical tape drawers holds 222 CDs or 90 VHS tapes
- Accommodates all big screens from 40"-60"
- Room for all your components
- Surround sound ready



**80" Big Screen Wall**

Real oak, holds 60 VHS or 120 CDs, accommodates 35" Big screen TV, removable speaker panels with oak inserts.



**\$768**

**\$1198**  
Pine wall



**British Tan Pine Wall**

Features on this casual pine entertainment wall include 35" TV monitor space, organized tape storage areas, lighted display areas and solid pine glass framed doors to keep your components dust free while allowing plenty of concealed storage. A Billy Bob's exclusive.

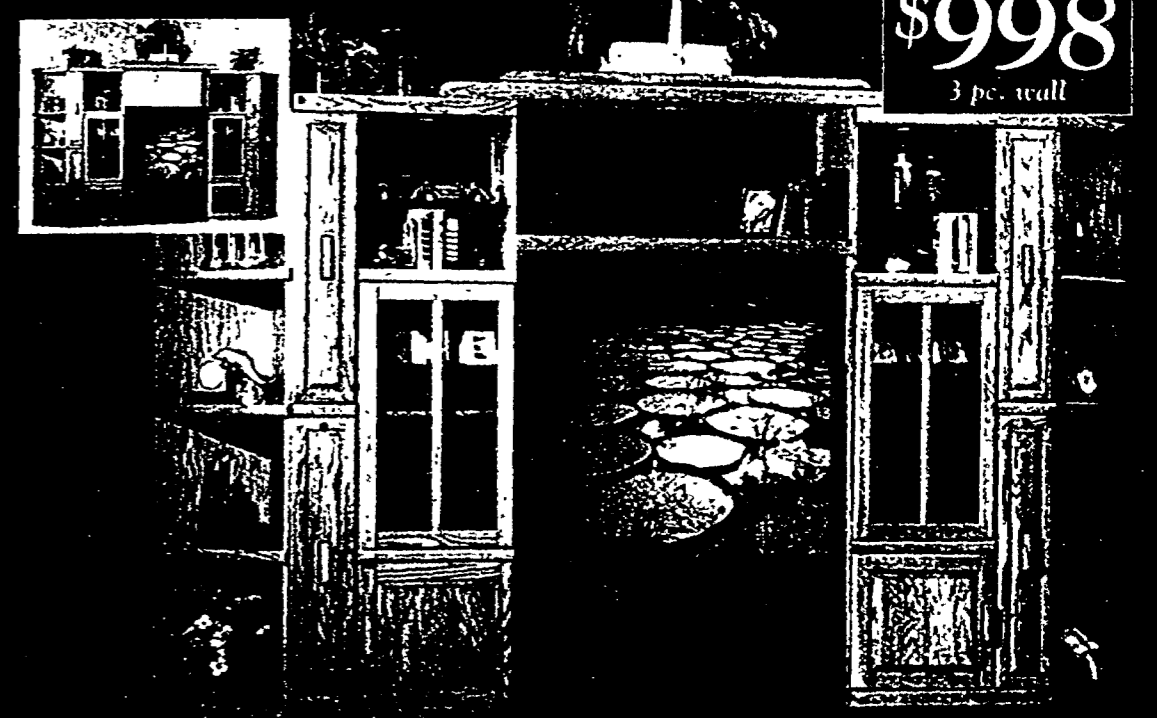

**Stretch Out In Style**

Our ultimate expandable home theater wall will accommodate any big screen TV up to 60". Left and right piers with light bridge feature two lighted curio display areas, glass door storage for all your audio and video components, two speaker-grille doors and storage for 120 VHS tapes or 240 CDs. Add beautiful accent corner wedges for only \$149.00 ea.



**\$998**  
3 pc. wall

**\$1498**  
as shown



**THANKSGIVING SAVINGS of 30-50% plus 6 MONTHS same as cash!**

**COUPON**  
 Solid Cherry Entertainment Center  
 MSRP: \$1799.00  
 SALE: \$998.00  
 LESS: \$200.00 coupon  
**\$798**

**Solid Cherry Entertainment Center**



A handsome and convenient way to store your audio/video components, this solid cherry entertainer features wrap-around door hinges and attractive bonnet-top molding. Accommodates most 31" TVs, and measures 80" high x 39 1/2" x 23 1/2" d.



**COUPON**  
 4 Piece Expandable Big Screen Wall  
 MSRP: \$1199.00  
 SALE: \$798.00  
 LESS: \$100.00 coupon  
**\$698**  
 Expires 12-5-96

**4 Piece Expandable Big Screen Wall**

Real oak, holds all TVs up to 60", lighted display areas, tape storage for 60 VHS or 120 CDs. Corner units available at \$148.00 ea.



**Holiday Buy #1**



**Holiday Buy #2**

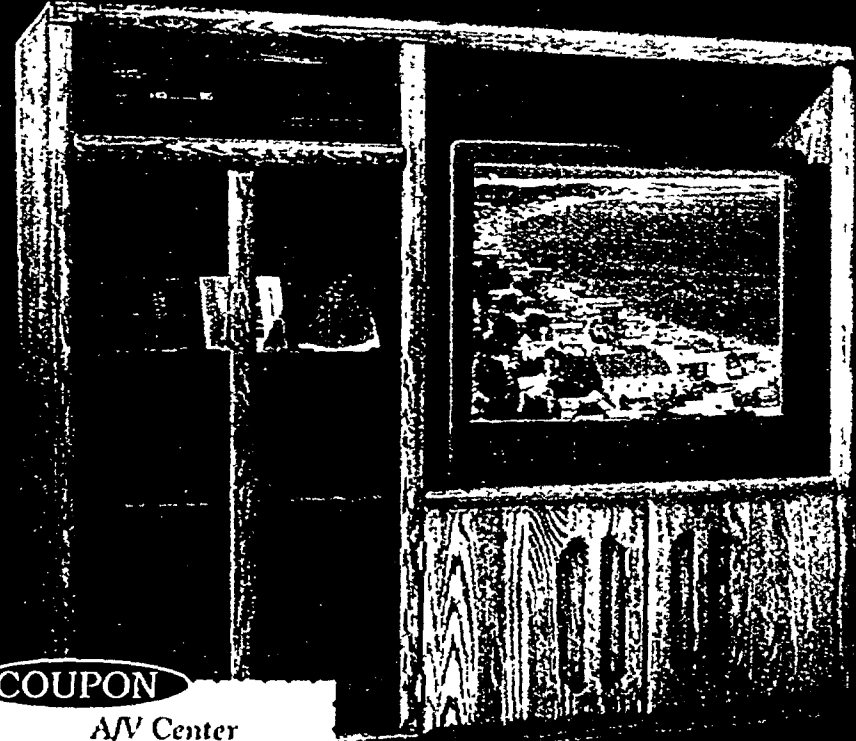

**COUPON**  
 AV Center  
 MSRP: \$499.00  
 SALE: \$298.00  
 LESS: \$50.00 coupon  
**\$248**  
 Expires 12-5-96

Real oak entertainment center features include 27" TV capacity, VCR shelf, roll out CD and cassette storage tray plus casters for easy mobility. Factory assembled in the USA.



**Holiday Buy #3**



**Holiday Buy #4**

**COUPON**  
 Save an additional \$50.00 off our entire collection of American made solid oak cabinets  
**\$50 OFF**  
 Expires 12-5-96

**Solid Oak Collector Cases**

In stock in assorted sizes and finishes. Ready to display your favorite collectibles.



**THE ANNIVERSARY OFFICE COLLECTION**



Three pieces as shown above \$1998.00.

The "Anniversary" Home Office Collection  
 A superbly blended combination of style function and traditional craftsmanship.

•Crafted of select black cherry veneers and North American hardwood solids for enduring value.

- 66" Executive desk ..... \$1298.00
- 32" Lateral file cabinet ..... \$498.00
- 81" High computer armoire ..... \$1198.00





# THANKSGIVING SPECTACULAR



**\$1798**

## 4x8 Brunswick Dakota

- Rich golden oak finish
- Italian slate
- Super Speed cushions
- Leather pockets
- Pearlized sights

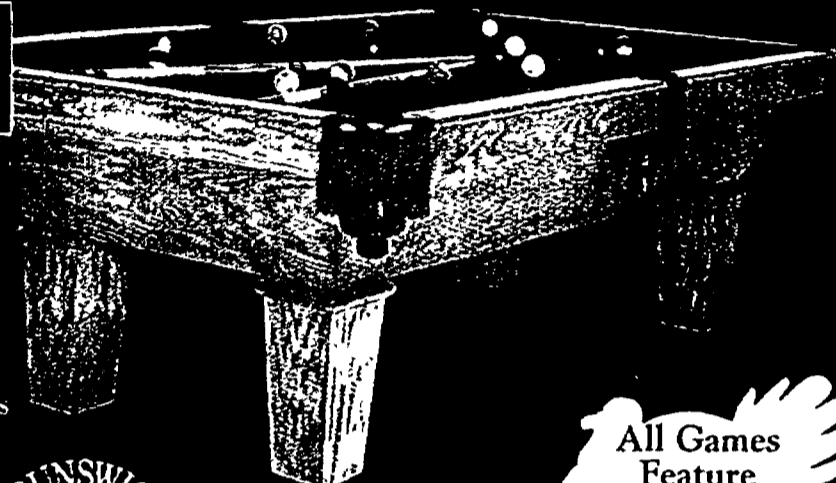

All Games Feature Billy Bob's Low Price Guarantee!



with instant rebate \$50

SALE NOW ONLY **\$448**

## Table Soccer

- Solid metal rods with easy grip handles
- Molded plastic team players are bolted to rods
- Sturdy 4" post legs
- Heavy duty cabinet
- Size 5x29x35

ESCALADE SPORTS

**\$698**

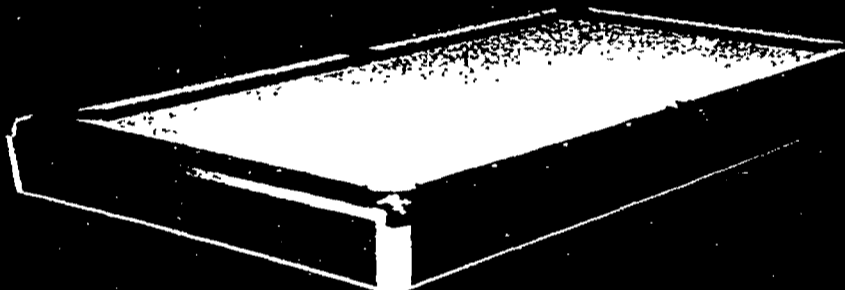

## Brunswick Hampton II

This sleek contemporary in black laminate with chrome accents features Italian slate along with burn and scratch resistant rails.

**\$1598**



## Real Oak Bar

- Solid oak raised panels
- Solid brass foot bar
- Cutting board built-in
- Three finishes: medium oak, dark oak and black cherry

## Oak & Leather Stools

- Solid oak • Real leather • 30" height
- Brass kick plate • Full swivel

**\$398**

**\$1998**

**\$1498**

## Oak Supreme II

- Burn, stain and scratch resistant
- Contemporary styling
- Three piece slate
- Hardwood rails



## Sierra 5 Piece Game Set 2-in-1

- Flip over top for cards or dining
- Solid oak construction
- Rocker/swivel chairs
- Leg levelers to ensure even surface
- Built-in chip trays and cup holders



ALL OTHER BRUNSWICK TABLES IN STOCK & ON SALE!

ALSO IN STOCK: SHUFFLE BOARDS • PINBALL GAMES • VEGAS SLOTS • AIR HOCKEY • FOOSBALL NEON • CAROUSEL HORSES • GAMING EQUIPMENT • DART SUPPLIES • WALL ART • ANTIQUES



Royal Oak 810-549-4263 W. Bloomfield 810-669-7101 Sterling Hts. 810-566-7300 Westland 313-467-8280



Qualified Buyers! Get up to **\$10,000 Credit** with the **Billy Bob's Card!**



Use only the Billy Bob's Card for all credit purchases. Good only for same as cash purchases with a 10% rebate. All other sales excluded. See store for details on price guarantee. Normal APR 20.25%

# MC SPORTS

You Win...Everytime!

# EARLY BIRDS!



**1/2 OFF!**

**AVIA**

**EARLY BIRD Special!**

While they last. No Rainchecks!

**\$24.99** Before 11 a.m.

**SAVE \$25.00**

**MEN'S & WOMEN'S LEATHER WALKING SHOE**  
Reg. 49.99  
After 11 a.m. - 29.99

Available in medium & wide widths.

**7am-11am FRIDAY ONLY!**  
Mall hours may vary.

Closed Thanksgiving Day...Open Late Fri./ Sat. til 10:00pm

**\$17.99** Before 11 a.m.

**SAVE \$22.00**

**MEN'S VISTA WALKING SHOE**  
Reg. 39.99  
After 11 a.m. - 19.99

Available in medium & wide widths.

While they last. No Rainchecks!

**EARLY BIRD Special!**

**YUKON**

**SAVE \$25.00**

While they last. No Rainchecks!

**EARLY BIRD Special!**

**YOUR CHOICE!**

**\$14.99** Before 11 a.m.

**FREESTYLE NIGHT HAWK or SHARK WATCH**  
Reg. 39.99  
After 11 a.m. - 19.99

**EARLY BIRD Special!**

While they last. No Rainchecks!

**SAVE \$10.00**

**\$9.99** Before 11 a.m.

**PRO QB GENUINE LEATHER FOOTBALL**  
Official size. Reg. 19.99  
After 11 a.m. - 12.99

**EARLY BIRD Special!**

While they last. No Rainchecks!

**SAVE \$32.00**

**\$17.99** Before 11 a.m.

**NCAA EDG3 COMPOSITE LEATHER BASKETBALL**  
Men's or 28.5" size. Reg. 49.99  
After 11 a.m. - 19.99

**EARLY BIRD Special!**

**SAVE \$35.00**

**\$24.99** Before 11 a.m.

**YOUTH ASTEROID INLINE SKATE**  
Reg. 59.99  
After 11 a.m. - 29.99

While they last. No Rainchecks!

**YOUTH HELMET**  
Reg. 39.99  
After 11 a.m. - 14.99

**SAVE \$30.00**

**EARLY BIRD Special!**

While they last. No Rainchecks!

**EARLY BIRD Special!**

**SAVE \$150.00**

**\$149.99** Before 11 a.m.

**ULTIMATE ALL GRAPHITE SHAFT 3/8 SET**  
Reg. 299.99  
After 11 a.m. - 169.99

**EARLY BIRD Special!**

While they last. No Rainchecks!

**SAVE \$25.00**

**\$14.99** Before 11 a.m.

**SKI POLES**  
Reg. 39.99  
After 11 a.m. - 19.99

**EARLY BIRD Special!**

While they last. No Rainchecks!

**SAVE \$60.00**

**\$49.99** Before 11 a.m.

**MEN'S BUGA BISON BOOT**  
Sz. 7-13. Reg. 109.99  
After 11 a.m. - 59.99

**EARLY BIRD Special!**

**\$279.99** Before 11 a.m.

**CROSSWALK TREADMILL**

- Dual-motion cross-trainer
- Total body conditioning
- Extended stride profile
- Powerful 1.5 hp DC motor
- 0-8 mph adjustable speed
- Adjustable auto-incline # PF70502. Reg. 399.99

After 11 a.m. - 299.99

While they last. No Rainchecks!

**SAVE \$120.00**

**PRO-FORM**



**"YOU WIN" Low Price Guarantee**

- We will not be undersold - period! If a competitor's price is less for the same item, we'll match it...No hassle!
- ALL Sporting Goods stores ads are our ads. Bring them in and we'll match them!



**SPECIAL PRICES GOOD THRU DECEMBER 7TH**

WHILE QUANTITIES LAST!  
Some merchandise may not be available in all stores.

**8 WAYS TO PURCHASE!**

- Cash • Check
- Gift Certificates
- Layaway, plus...

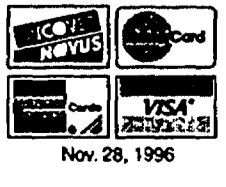

Ski product not available in our Ward Parkway, Olathe, Blue Ridge, and Benjamin Plaza locations.

# MC SPORTS

# Winter Ski Values!

**EARLY BIRDS!**



**7am-11am FRIDAY ONLY!**  
Mall hours may vary.

**Just for Kids!**

**Complete Ski Package!**



**SAVE \$59.97**

**DYNASTAR**  
**ROSSIGNOL**

**\$229.99**

**DYNASTAR X5 OR ROSSIGNOL STJ SKI PACKAGE**  
Nordica Super M01 Jr. boots Salomon Quad 3 binding Kerma Jr Poles MC Reg 289.96

**Complete Ski Package!**



**MARKER**  
**SALOMON**

**EARLY BIRD Special!**

While they last. No Rainchecks!

**SAVE \$169.97**

**ATOMIC**

**\$289.99**

**AXC 1 SKI PACKAGE**  
Choose from Marker M27 or Salomon Quad 5 bindings. Scott Poles. MC Reg. 359.97

**SAVE \$69.98**

**ROSSIGNOL**

**\$299.99**

**STK SKI PACKAGE**  
Choose from Marker M27 or Salomon Quad 5 bindings. Scott Poles. MC Reg. 369.97

**SAVE \$69.98**

**SAVE \$49.98**

**\$379.99**

**MEN'S OR WOMEN'S TWO SKI PACKAGE**  
Choose from Marker M27 or Salomon Quad 5 bindings. Scott Poles. MC Reg. 429.97

**ROSSIGNOL**

**\$379.99**

**CUT 10.4 SKI PACKAGE**  
Choose from Marker M27 or Salomon Quad 5 bindings. Scott Poles. MC Reg. 429.97

**SAVE \$49.98**

**exel**

**SAVE \$26.97**

**\$129.99**

**EXEL NAVIGATOR CROSS-COUNTRY SKI PACKAGE**  
Exel Aurora 75 mm Boot. 75 mm Binding. Nova Poles. Reg. 156.96

**FISCHER**

**SAVE \$47.97**

**\$189.99**

**FISCHER STANDARD CROWN CROSS-COUNTRY SKI PACKAGE**  
Tamarak NNN Boot. NNN bindings. Nova Poles. Reg. 237.96

**\$279.99**

**M5 SKI PACKAGE**  
Before 11 a.m. Nordica AFX 46 men's or women's boot. Marker M27 or Salomon Quad 5 binding. Scott Poles. Reg. 449.96  
After 11 a.m. - 329.99

**SAVE \$17.00**

**uvex**

**EARLY BIRD Special!**

**CORNICE SKI GOGGLE**  
Reg. 31.99  
After 11 a.m. - 19.99

**Before 11 a.m.**

**SKI & BOOT BAG COMBO**  
Reg. 29.99  
After 11 a.m. - 24.99

**SAVE \$80.00**

**NORDICA**

**MEN'S OR WOMEN'S SYNTECH 5.8 SKI BOOT**  
**\$99.99**  
Reg. 179.99

**LANGE USA**

**WOMEN'S 3.6 SKI BOOT**  
**\$149.99**  
Reg. 159.99

**SAVE \$10.00**

**SCOTT**

**\$16.99 [A] GT 500**  
Reg. 21.99

**\$16.99 [B] SUN VALLEY**  
Reg. 24.99

**\$19.99 [C] GT 700**  
Reg. 31.99

**\$24.99 [D] GT 800 OTG**  
Reg. 34.99

**\$29.99 [A] SINGLE SKI BAG**  
Reg. 39.99

**\$19.99 [B] SINGLE SKI BAG**  
Reg. 24.99

**\$14.99 [C] BOOT BAG**  
Reg. 19.99

**20% OFF**

**SKI TOTE ACCESSORIES**  
Selection varies by store.

**SAVE \$10.00**

**Sport VALISE**

**EARLY BIRD Special!**

While they last. No Rainchecks!

**SAVE \$10.00**

**Raichle**

**CX 4.4 SKI BOOT**  
**\$149.99**  
Reg. 159.99

**NORDICA**

**MEN'S OR WOMEN'S GP03 SKI BOOT**  
**\$169.99**  
Reg. 179.99

**SAVE \$10.00**



# Ski Fashion Wear Savings!



**Columbia**  
Sportswear Company

SELECTED  
MEN'S & WOMEN'S  
COLUMBIA PARKAS

**\$20<sup>00</sup> OFF**  
Reg. Prices

Assorted styles & sizes to  
choose from. Selection varies.  
Reg. 149.99 to 174.99

Check Out  
Columbia's Variety  
of Great Fashion  
Colors Only at  
MC SPORTS!



SAVE  
**\$20<sup>00</sup>**

**\$69<sup>99</sup>**

**RAEWIKS  
WOMEN'S  
PARKAS**

Water-proof microfiber construction. Quilted  
lining. Assorted sizes. # L13/15  
Reg. 89.99

**edelweiss**



**MEN'S  
SKI BIB  
OR WIND  
PANT**

# 20205/07  
Reg. 44.99

**\$34<sup>99</sup>**

Your  
Choice!

SAVE  
**\$10<sup>00</sup>**



**\$10<sup>00</sup> OFF**  
Reg. Prices

**MEN'S & WOMEN'S  
FLEECE SWEATERS**  
Reg. 49.99 to 89.99



**duofold<sup>®</sup>**

YOUR CHOICE!

**\$16<sup>99</sup>**

**MEN'S &  
WOMEN'S LONG  
UNDERWEAR**

2-layer construction  
for warmth. Outer  
layer-wool, inner  
layer-cotton.  
Reg. 19.99 to 22.99

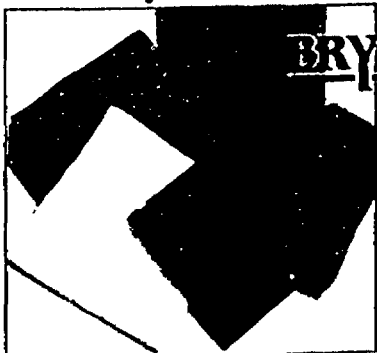

**BRYSTIE inc.**

**\$6<sup>99</sup>**

**TURTLE FUR  
NECK  
GATORS**  
Assorted colors.  
Reg. 8.99

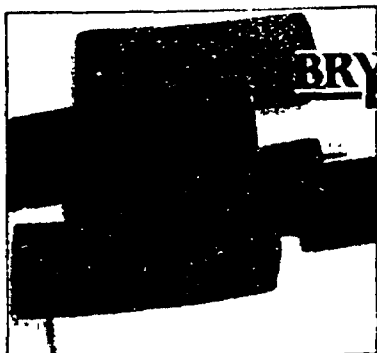

**BRYSTIE inc.**

**\$4<sup>99</sup>**

**TURTLE FUR  
HEADBANDS**  
Assorted colors.  
Reg. 6.99



**HOTfingers<sup>®</sup>**

**\$5<sup>00</sup>  
OFF**  
Reg. Prices

**MEN'S &  
WOMEN'S GLOVES**  
Assorted styles & sizes.  
Reg. 24.99 to 39.99



**MANZELLA<sup>®</sup>**

**20%  
OFF**  
Reg. Prices

**GLOVES  
& LINERS**  
Assorted styles & sizes.  
Reg. 3.99 to 16.99



**\$9<sup>99</sup>**

**SEIRUS  
FACE MASK**  
Thermal face protection.  
Assorted colors. Reg. 12.99

**EARLY BIRDS!**  
7am-11am FRIDAY ONLY!  
Mall hours may vary.



**YOUR CHOICE!**  
**\$19.99**  
BEFORE 11:00 A.M.  
While they last. No Rainchecks!  
**BROOKS**  
WOMEN'S PASSION or MEN'S FIRM CROSS-TRAINERS  
# 23309/31142. Reg. 39.99  
AFTER 11:00 A.M. - 24.99



**YOUR CHOICE!**  
**\$29.99**  
BEFORE 11:00 A.M.  
While they last. No Rainchecks!  
**Dexter FootJoy**  
WOMEN'S MARION or MEN'S GREENJOY SADDLE GOLF SHOES  
# F980-9/45195. Reg. 49.99  
AFTER 11:00 A.M. - 39.99



**SWITCH-IT**  
**\$49.99**  
BEFORE 11:00 A.M.  
While they last. No Rainchecks!  
**CRUISE 3-IN-1 SKATE**  
Sz. 3-12 # CRUISE 3:1. Reg. 79.99  
AFTER 11:00 A.M. - 59.99

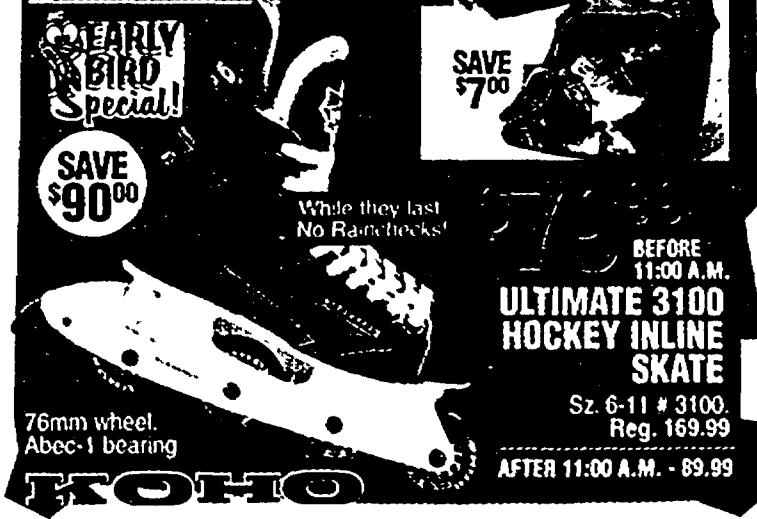

**ULTIMATE 3100 HOCKEY INLINE SKATE**  
Sz. 6-11 # 3100. Reg. 169.99  
AFTER 11:00 A.M. - 89.99

**MC SPORTS**  
You Win...Everytime!

**20% To 40% OFF**  
Reg. Prices



**ENTIRE STOCK!**  
**MEN'S, WOMEN'S & YOUTH REEBOK SHOES**  
Assorted styles & sizes to choose from. Selection varies by store. Excludes Value Price and Clearance items.



**\$29.99**  
MEN'S ZURICH ALL-COURT # 0058-108. Reg. 49.99  
**\$29.99**  
MEN'S COMPETITION COURT SHOE # 80156. Reg. 49.99



**\$17.99**  
YOUTH KATARINA CLASSIC ICE SKATE  
**\$99.99**  
MEN'S & WOMEN'S SPIRITBLADE INLINE SKATES  
**\$49.99**  
MEN'S 3500 HOCKEY SKATE # M3500. Reg. 69.99  
**\$69.99**  
MEN'S GRETSKY HOCKEY SKATE # 99  
**\$44.99**  
YOUTH 3500 HOCKEY SKATE. Not pictured. # B3500. Reg. 59.99



**RUSSELL ATHLETIC**  
Oversized cut. Left chest embroidered design. Assorted colors & sizes # H-9801. Reg. 29.99  
**UMBRO**  
LIMIT THE GAME

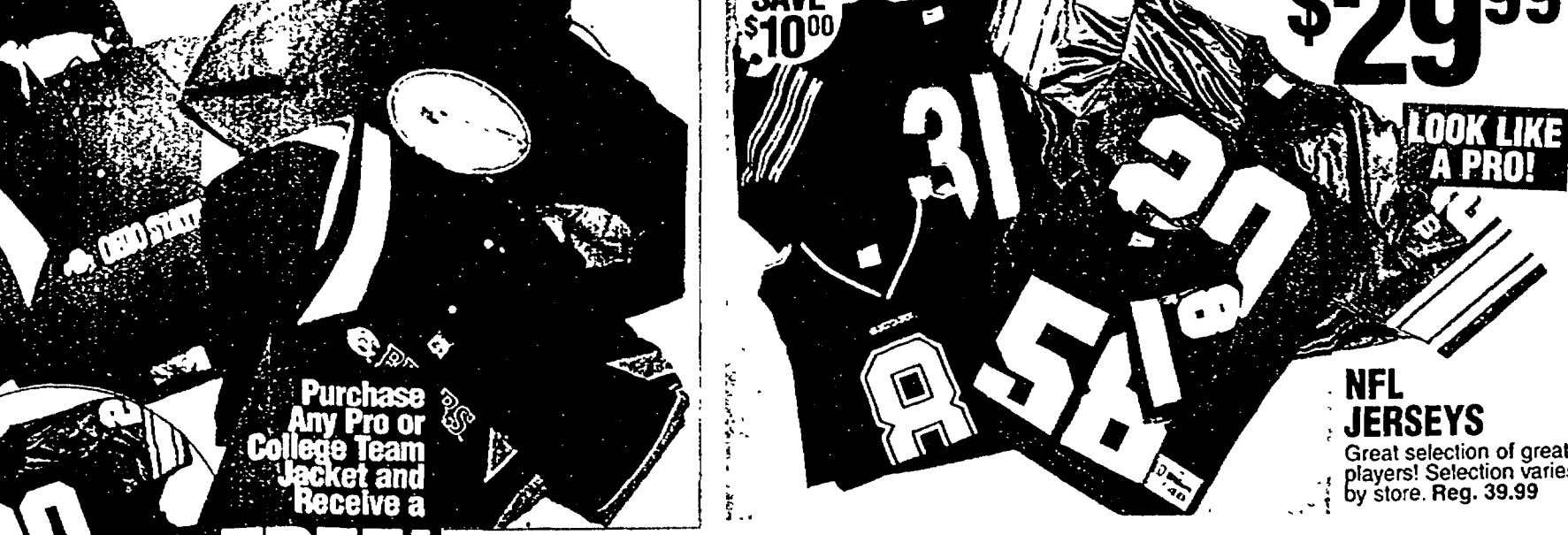

**\$19.99**  
HIGH-COTTON SWEATSHIRTS  
**\$19.99**  
UMBRO EMBROIDERED SWEATSHIRTS  
80% cotton blend w/embroidered design. Assorted colors available. Sz. M-XXL. Reg. 34.99  
**SAVE \$10.00**  
**SAVE \$10.00**  
**FREE! NFL JERSEY!**  
Purchase Any Pro or College Team Jacket and Receive a FREE! NFL JERSEY! A \$40.00 Value!  
**PRO & COLLEGE TEAM JACKETS**  
Pull-over & full zip styles to choose from. Team selection varies by store. Reg. 79.99 to 119.99



**\$9.99**  
YOUTH LINED WIND PANT  
Reg. 14.99  
**\$5.00 OFF**  
Reg. Prices  
**20% OFF**  
Reg. Prices  
**ALL IN-STOCK OSHKOSH FLANNEL & CHAMOIS SHIRTS**  
100% cotton construction. 9 oz. "Brawny" woven flannel or 6 oz. solid chamois. Reg. 26.99 to 32.99  
**25% OFF**  
Reg. Prices  
**WOMEN'S FLEECE PANTS & TOPS**  
Marika, Russell, Danskin & Reebok styles to choose from. Selection varies by store. Reg. 19.99 to 39.99

**EARLY BIRDS!**  
7am-11am FRIDAY ONLY!  
Mall hours may vary.



**WATERPROOF HIKERS**  
**\$29.99**  
BEFORE 11:00 A.M.  
While they last. No Rainchecks!  
**MEN'S MONTEBELLO HIKING SHOE**  
Reg. 99.99  
**YOUR CHOICE!**  
**\$29.99**  
BEFORE 11:00 A.M.  
While they last. No Rainchecks!  
**MEN'S ELITE HIKING SHOE**  
Reg. 99.99  
**K-SWISS**  
**\$39.99**  
BEFORE 11:00 A.M.  
While they last. No Rainchecks!  
**MEN'S PONTANO HIKING SHOE**  
# 0033-201. Reg. 129.99  
AFTER 11:00 A.M. - 44.99



**YOUR CHOICE!**  
**\$19.99**  
BEFORE 11:00 A.M.  
While they last. No Rainchecks!  
**MEN'S GREEN MOUNTAIN HIKING SHOE**  
Sz. 9.5-13 # 2485/89. Reg. 64.99  
**MEN'S ALTA HIKING SHOE**  
# 96710. Reg. 39.99  
AFTER 11:00 A.M. - 24.99  
**WOMEN'S HIKING SHOES!**  
**\$19.99**  
BEFORE 11:00 A.M.  
While they last. No Rainchecks!  
**WOMEN'S FORET HIKING SHOE**  
# 9043-274. Reg. 69.99  
AFTER 11:00 A.M. - 24.99  
**WOMEN'S LARAMIE HIKING SHOE**  
# 81234. Reg. 84.99  
AFTER 11:00 A.M. - 29.99



**YOUR CHOICE!**  
**\$19.99**  
BEFORE 11:00 A.M.  
While they last. No Rainchecks!  
**FLEECE CREWS & PANTS**  
Assorted colors & sizes. Reg. 16.99  
AFTER 11:00 A.M. - 13.99  
**RUSSELL ATHLETIC**

# EARLY BIRDS!

7am-11am FRIDAY ONLY!  
Mall hours may vary.

**SPORTCRAFT**

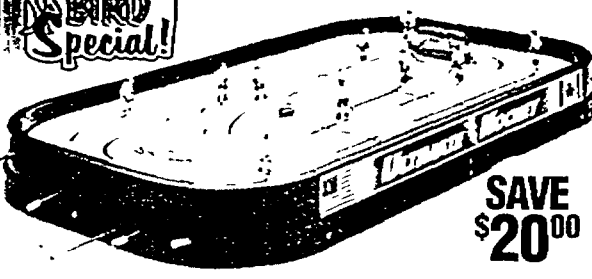

**SAVE \$20.00**

**ROD HOCKEY**  
Precision nylon gearing for smooth action. Ultra-smooth surface insures fast-action fun.  
# 11064. Reg. 69.99  
After 11 a.m. - 59.99

**EAOSTON.**

**LITTLE LEAGUE BAT**  
Assorted sizes. Aircraft aluminum. # LK9. Reg. 39.99  
After 11 a.m. - 24.99

**Rawlings**

**NCAA CHAMPIONSHIP RUBBER BASKETBALL**  
Available in official, 28.5 & youth sizes. # CHAMP. Reg. 7.99  
After 11 a.m. - 5.99

**EAOSTON.**

**LEATHER 11" LITTLE LEAGUE BALLGLOVE**  
Available for both right & left handed players. # EX514. Reg. 39.99  
After 11 a.m. - 19.99

**CORSICA 4 PC. COMBO**  
Reg. 29.99  
After 11 a.m. - 24.99

**SAVE \$10.00**

## HOLIDAY SPORTS SALE

Our official TEAMMATES CAPTAIN  
**KAREEM ABDUL-JABBAR**



Help your school, church, or charity team get **NEW SPORTS EQUIPMENT... AT NO COST TO THEM!**  
-join- **MC TEAMmates®**  
Over 8000 groups & organizations have already joined!

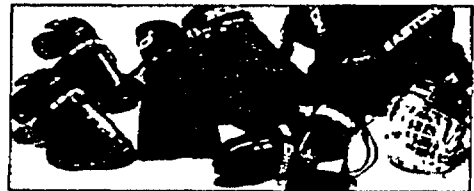

**20% OFF** Reg. Prices  
**SELECTED ICE HOCKEY PROTECTIVE GEAR**  
Excludes clearance.

**EAOSTON.**

**INSTINCT 28" HOCKEY BAG**  
# A163737. Reg. 24.99  
**SAVE \$5.00**

**Mitre**

**MLS REPLICIA SOCCERBALL**  
# 7020. Reg. 24.99  
**SAVE \$5.00**

**Molten**

**DAKOTA SYNTHETIC LEATHER SOCCERBALL**  
# HS-DAK. Reg. 9.99  
**SAVE \$2.00**

**Soccer Pal**

**SOCCER PAL SOCCER TRAINER**  
Helps players improve skills. Reg. 7.99  
**SAVE \$1.00**

**EAOSTON.**

**ULTRA PRO 54" GOAL**  
# A150705. Reg. 39.99  
**SAVE \$10.00**

**EAOSTON.**

**54" ALL-PURPOSE GOAL**  
# APG1500. Reg. 29.99  
**SAVE \$10.00**

**SPALDING**

**NBA SYNTHETIC LEATHER BASKETBALL**  
Official & 28.5". # 62-101/174. Reg. 24.99  
**SAVE \$5.00**

**LIFETIME**

**44" ACRYLIC INGROUND BASKETBALL SYSTEM**  
Adjustable pole. # 1725. Reg. 199.99  
**SAVE \$50.00**

**asics.**

**VOLLEYBALL KNEEPADS**  
One size fits all. White & black. # ZD09. Reg. 14.99  
**SAVE \$2.00**

**KOHO**

**STREET HOCKEY GOALIE HELMET**  
# GF55. Reg. 34.99  
**SAVE \$10.00**

**KOHO**

**LEMIEUX STREET HOCKEY # SH66 STICK**  
Thermoplastic blade. Junior/Senior size. **SAVE \$1.00**  
**PEE WEE SIZE STICK** # 899

**Wilson**

**1001-P FULL-GRAIN LEATHER FOOTBALL**  
Official size & weight. # F1235. Reg. 44.99  
**SAVE \$5.00**

**Wilson**

**OFFICIAL NFL GAME FOOTBALL**  
Made of premium select leather. # F1000  
**SAVE \$10.00**

**SPALDING**

**TF1000 COMPOSITE LEATHER VOLLEYBALL**  
# 61-802. Reg. 39.99  
**SAVE \$10.00**

### INDOOR GAMES! GREAT HOLIDAY GIFT IDEAS FOR THE WHOLE FAMILY!

**SPORTCRAFT**

**BUTCHER BLOCK FOOSBALL**  
Heavy Duty Butcher Block style for rugged durability. # 27093. Reg. 349.99  
**SAVE \$50.00**

**YOUR CHOICE!**

**\$299.99**

**SPORTCRAFT**

**TURBO AIR HOCKEY**  
Heavy Duty wood frame construction. Sturdy 1 1/8" tubular steel legs. # 27086  
**SAVE \$10.00**

**YOUR CHOICE!**

**\$99.99**

**Recreational Products**

**7' POOL TABLE W/ ACCESSORIES**  
Adjustable leg levelers. Professional size drop pockets, 3/4" playfield & steel frame. # 25175A  
**SAVE \$10.00**

**YOUR CHOICE!**

**\$69.99**

**SPORTCRAFT**

**4 PLAYER CRICKET ELECTRONIC DARTBOARD**  
# 79070. Reg. 89.99  
**SAVE \$20.00**

**Challenge Soccer**

**CHALLENGE SOCCER**  
Heavy Duty wood frame construction. Sturdy 1 1/8" tubular steel legs. # 27081  
**SAVE \$10.00**

**HARVARD**

**AMERICAN TABLE TENNIS TABLE**  
# T8005. Reg. 229.99  
**SAVE \$30.00**

**SPORTCRAFT**

**4 PLAYER CRICKET ELECTRONIC DARTBOARD**  
# 79070. Reg. 89.99  
**SAVE \$20.00**

**Technid.**

**CRICKET-MASTER 4 ELECTRONIC DARTBOARD**  
# 450ARA. Orig. 299.99  
**SAVE \$120.00**

# MC SPORTS

You Win...Everytime!



**SAVE \$30<sup>00</sup>**

- 100% TITANIUM FACE
- Graphite Shaft

## TREND



**\$49<sup>99</sup>**

**OVERSIZED TITANIUM FACED VERTEX GRAPHITE SHAFTED DRIVER**

Oversized head shape. Graphite shaft w/bulge. Men's rt. hand only. Reg. 79.99



**SAVE \$10<sup>00</sup>**

A. **HIGHLANDER STAND GOLF BAG**  
Full length dividers for graphite shaft protection. Reg. 89.99

B. **GOLF CLUB HARD CASE**  
# 72000. Reg. 59.99

**\$79<sup>99</sup>**

**A. HIGHLANDER STAND GOLF BAG**  
Full length dividers for graphite shaft protection. Reg. 89.99

**\$49<sup>99</sup>**

**B. GOLF CLUB HARD CASE**  
# 72000. Reg. 59.99

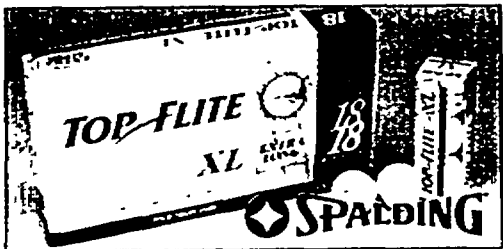

**\$14<sup>99</sup>**

**TOP FLITE XL 18-PACK GOLF BALLS**  
Choose regular or tour flight trajectories. Reg. 16.99

**\$99<sup>99</sup>**

**CATALYST GRAPHITE RACQUETBALL RACKET**  
Cushion Response System™ handle. Reg. 199.99

**EKTELON**

**INCLUDES THERMAL COVER!**

**SAVE \$100<sup>00</sup>**



**\$99<sup>99</sup>**

**EDGE GRAPHITE RACQUETBALL RACKET**  
Pyramid Power Technology. Reg. 59.99

**HEAD**

**INCLUDES COVER!**

**SAVE \$10<sup>00</sup>**

**\$49<sup>99</sup>**

# EARLY BIRDS!

**7am-11am FRIDAY ONLY!**  
Mall hours may vary.



**EARLY BIRD Special!**

**GRAPHITE SHAFTED DRIVER**

**SAVE \$50<sup>00</sup>**

**\$99<sup>99</sup>** Before 11:00 A.M.

**CONCORDE 11-PIECE GOLF SET**

While they last No Rainchecks!

Brunswick lightweight, 1.5" step pattern, steel shafts. Hi-pressure cast alloy, oversize heads. Men's right/left & women's right hands available. Men's mid-firm flex, women's micro-light flex. Reg. 149.99

**After 11:00 A.M. - 119.99**



**Bag Boy**

**EARLY BIRD Special!**

**SAVE \$20<sup>00</sup>**

**\$299<sup>99</sup>** Before 11:00 A.M.

**RANGER GOLF CART**

Steel square tube construction. Includes scorecard holder. Reg. 49.99

While they last No Rainchecks!

**After 11:00 A.M. - 34.99**

**prince**

**EXTENDER**

**SAVE \$120<sup>00</sup>**

**\$599<sup>99</sup>** Before 11:00 A.M.

**EXTENDER LIGHTNING TENNIS RACKET**

100% graphite composition. Mid-plus head size-104". Firm-flex. Unstrung. Reg. 179.99

While they last No Rainchecks!

**After 11:00 A.M. - 69.99**

**CHAPERONE DAY PACK**

Waterproof construction. Reflective stripe for night safety. Reg. 34.99

While they last No Rainchecks!

**After 11:00 A.M. - 19.99**

**EARLY BIRD Special!**

**SAVE \$20<sup>00</sup>**

**EASTPAX**

**SAVE \$700**

**\$1499** Before 11:00 A.M.

**15-IN-1 MULTI TOOL**

Reg. 14.99

While they last No Rainchecks!

**After 11:00 A.M. - 9.99**

## GEAR UP FOR OUTDOOR SAVINGS AT MC SPORTS!

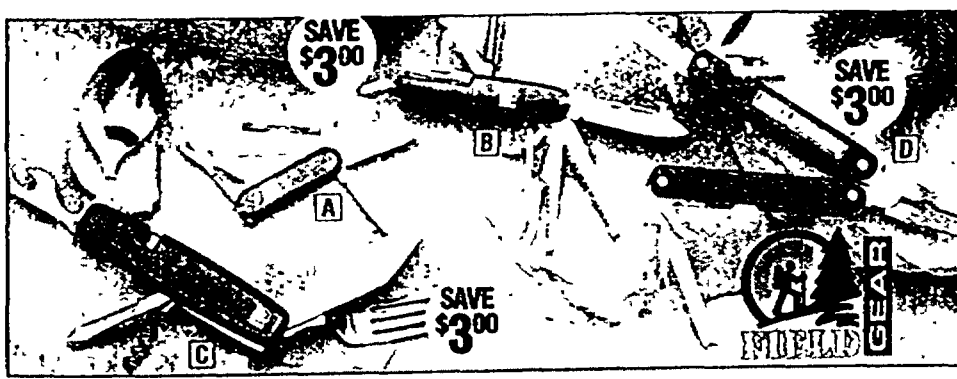

**SAVE \$3<sup>00</sup>**

**SAVE \$3<sup>00</sup>**

**SAVE \$3<sup>00</sup>**

**SAVE \$3<sup>00</sup>**

**\$199** **A 6-IN-1 FIELD MATE KNIFE**  
Blade, scissors, nail file, toothpick, tweezers & key ring. # 01962-8. Reg. 2.99

**\$499** **B 14-IN-1 FIELD PRO KNIFE**  
Stainless steel construction. 5 yr. warranty. Great multi purpose knife. # 01964-2. Reg. 7.99

**\$499** **C 8-IN-1 MESS KIT KNIFE**  
Stainless steel construction. 5 yr. warranty. Great for scouts! # 01966-6. Reg. 7.99

**\$699** **D TRAIL BLAZER MULTI-TOOL**  
Stainless steel multi-function pliers. 12 functions! Screwdrivers, pliers & more. # 01968. Reg. 9.99



**SAVE \$10<sup>00</sup>**

**SAVE \$10<sup>00</sup>**

**SAVE \$300**

**\$29<sup>99</sup>**

**POLAR FLEECE BLANKET/SLEEPING BAG LINER**  
Great for around the house or at the campsite! Reg. 39.99

**MZH SLEEPING BAG**

**SAVE \$10<sup>00</sup>**

**\$19<sup>99</sup>**

**WHITE PINE SLEEPING BAG**  
3 lbs. Hollofil 808 insulation Rated to +30°F. Reg. 29.99

**CAMP TRAILS**  
OUTDOOR GEAR SINCE 1911

**\$59<sup>99</sup>**

**SONORA INTERNAL FRAME PACK**  
Reg. 79.99

**Special Purchase!**

**SAVE \$20<sup>00</sup>**

**SAVE \$7<sup>00</sup>**

**OPRENIC**

**\$7<sup>99</sup>**

**COMPACT 12-VOLT FLOODLIGHT**  
# WL-1015. Reg. 14.99

**SAVE \$5<sup>00</sup>**

**OPRENIC**

**\$3<sup>99</sup>**

**NIGHTBLASTER FLUORESCENT LIGHT**  
# FL-601C. Reg. 8.99

# MC SPORTS FITNESS CENTER

**FREE!**  
1 lb. set of hexagon dumbbells with any purchase over \$20.00.

7am-11am FRIDAY ONLY!  
Mall hours may vary.

## HealthRider

**SAVE \$60.00**

**ELECTRONIC CONSOLE FOR WORKOUT FEEDBACK!**



**\$139.99**

**LOWEST PRICE EVER!**  
**HEALTHRIDER SPORTRIDER**  
Straight handlebar revolves 360° for maximum wrist & arm flexing. Adjustable seat for individual comfort. Electronic console for workout feedback. Some assembly required. 1 yr. warranty. # MACSP-0295. Reg. 199.99

The Surgeon General has determined that moderate levels of physical activity will significantly reduce your risk of heart disease, diabetes, and some cancers.



**PRO-FORM**

**SAVE \$100.00**

**\$399.99** SPACE SAVER 530 TREADMILL

- 0-10 mph, 2.0 hp air-stride floating deck
- Four window LCD feedback electronics
- Express lift auto-incline # PFTL5306 Reg. 499.99



**WEIDER**

**\$299.99**

**8530 DUAL STACK HOME GYM**  
• Vinyl encased dual stack  
• 210 lbs. resistance on bench press  
• Allows 2 people to workout at once  
• Separate bench press & butterfly stations  
# WESY8530



**WEIDER**

**\$99.99**

**LAT BENCH COMBO**  
• Space Max foldaway design  
• Adjust. back height  
• Lat tower  
• Leg Developer  
• Standard weight  
# WEBE1506 Reg. 129.99



**THOR**

**SAVE \$10.00**

**\$19.99** 35 LB. DUMBBELL # 7209. Reg. 29.99



**WEIDER**

**\$49.99** AB SHAPER # WEMC-2026



**PRO-FORM**

**\$79.99** AB RESISTER # PFMC-2026



**SAVE \$5.00**

**\$19.99** KATHY IRELAND STEP # 602. Reg. 24.99



**PRO-FORM**

**\$499.99** Before 11 A.M.

**CROSSWALK SPACE SAVER TREADMILL**  
• 0-10 mph, 2.0 hp  
• Air-stride floating deck with ratchet inline  
• Four window feedback  
• Thumb-pulse sensor  
• Performant lubrication system  
• Uni-track alignment  
• Pro-tech key  
• Console holds water bottle, remote, & towel (not included) # PFTL2046  
Orig. 599.99

**EARLY BIRD Special!**

**SAVE \$100.00**

While they last. No Rainchecks!

After 11 A.M. 549.99



**EARLY BIRD Special!**

**SAVE \$60.00**

**IMPEx**

**MID-SIZE BENCH**  
• Independent institutional style bar incline supports  
• No pinch chrome "lockdown"  
• Adjust. dual action legs  
• Curl extension with 6 oversize foam rolls  
• Accommodates deluxe arm & lat accessories  
• Sliding seat with seat angle adjustment  
# CB747. Reg. 149.99

Before 11 A.M.

After 11 a.m. - 99.99

While they last. No Rainchecks!



**110 LB. SPINLOCK WEIGHT SET**  
• Solid steel chrome-plated bars  
• Solid iron standard weight plates  
• Includes 1-6" bar, 2-14" dumbbell handles # G531

Before 11 A.M.

After 11 a.m. - 49.99



**GOLD GYM**

**EARLY BIRD Special!**

**SAVE \$10.00**

While they last. No Rainchecks!



**EARLY BIRD Special!**

**SAVE \$20.00**

**65 LB. TRAINING BAG COMBO**  
Includes 65 lb. heavy bag w/ attachment chain & one pair of 5 oz. bag gloves. # HB 5065C. Reg. 69.99

While they last. No Rainchecks!

After 11 a.m. - 59.99

**Stop-in and save at one of our many midwest locations where YOU WIN... everytime!**

**MICHIGAN LOCATIONS**

**DETROIT**  
Taylor - 22325 Eureka Rd. • 374-5202  
Westland - 6613 N. Wayne • 326-0888  
Pontiac - 450 Telegraph Rd. • 335-2226  
Livonia - 7 Mile at Middlebelt • 471-5570  
Roseville - Grabot at 12 Mile • 445-2022  
Warren - Hoover-Eleven Cntr. • 757-0525  
Oakland Mall - I-75 at 14 Mile • 563-7710  
Sterling Heights - Schroeder at M-59 • 254-3820  
Brighton - 8451 W. Grand River • 227-4819

**GRAND RAPIDS** - Rogers Plaza • 538-2120  
Plainfield Plaza • 363-2838  
3160 E. 28th St. • 949-8510

**MUSKOGEE** - Muskegon Mall • 722-3322  
Westshore Plaza • 733-2949

**HOLLAND** - North Park Plaza • 394-0648  
**KALAMAZOO** - Southland Mall • 327-4826  
**OKEMOS** - Meridian Mall • 349-3700  
**LANSHING** - 5002 W. Saginaw • 323-1663  
**S. LANSING** - 6250 S. Cedar • 272-9803  
**FLINT** - Oakbrook Sq. • 733-6730  
**MT. PLEASANT** - 1414 S. Mission St. • 773-0533  
**JACKSON** - Jackson Crossing • 789-6655  
**ANN ARBOR** - Oak Valley Cntr. • 996-0404  
**TRAVERSE CITY** - 3480 S. Airport Rd. West • 933-6158

**OHIO LOCATIONS**

**CLEVELAND**  
Mayfield Hts. 1405 SOM. Cntr. • 442-5827  
Great Northern Plaza • 779-1090  
Parma Hts. 7011-130th St. • 866-3600  
Points East Shopping Cntr. • 946-0035

**AKRON**  
Chapel Hill 1944 Buchholz Blvd. • 630-1880  
West Market Plaza • 666-4035

**MAURSFIELD**  
Springfield Sq. Shopping Cntr. • 529-5771

**MEDINA** - 980 N. Court St. • 723-0806  
**CALCUTTA** - Walmart Plaza • 385-4764  
**CANTON** - Springbrook Plaza • 492-5037

**TOLEDO**  
2255 South Reynolds Rd. • 382-1510  
3550 Executive Pkwy. • 536-1571

**DAYTON**  
1085 Marnsburg/Centerville Rd. • 438-0165  
8220 Old Troy Pike • 235-0026  
Salem Consumer's Sq. • 837-1177  
**LIMA** - 904 North Cable • 222-1144  
**FINDLAY** - 2330 Tiffin Ave. • 425-5200

**ILLINOIS LOCATIONS**

**CHICAGO**  
Wheaton - Danada Sq. E. • (630)655-4051  
Oaklawn - 89th & Cicero • (708)636-3443  
Joliet - Joliet Commons • (815)254-2451  
Oakbrook - Oakbrook Cntr. • (630)574-9494  
Golf Mill - 575 Golf Mill Rd. • (708)297-0230  
Woodridge - 75th & Lemont • (630)910-0300  
West Dundee - Spring Hill Mall • (847)428-8470  
Norridge - Harlem Irving Plaza • (708)453-5115  
Arlington Hts. - Rand & Palatine Rd. • (847)740-6000  
Round Lake Beach - Rollins Crossing • (847)740-4510  
Harver Park - Tradewinds Shopping Cntr. • (708)736-1664

**PERU** - Peru Mall • 224-3546  
**PEORIA** - Shendan Village • 688-8211  
**NORMAL** - College Hills Mall • 454-1122  
**ROCKFORD** - Cherry Vale Mall • 332-9411  
**BRADLEY** - Watertower Plaza • 933-1824  
**CHAMPAIGN** - Marketview Plaza • 356-9642  
**SPRINGFIELD** - Town & Country Plaza • 698-8801

**INDIANA LOCATIONS**

**GOSHEN** - 4024 Elhart • 875-1150  
**MERRILLVILLE** - Southlake Mall • 769-9075  
**MICHIGAN CITY** - 4106 S. Franklin • 878-0021  
**FORT WAYNE** - Next to Glenbrook Mall • 484-6559  
**HIGHLAND** - 10239 Indianapolis Blvd. • 924-3792

**MISSOURI/KANSAS LOCATIONS**

**SPRINGFIELD, MO** - 2832 S. Glenstone • 889-5458  
**COLUMBIA, MO** - Columbia Mall • Stadium Dr & I-70 • 445-9481  
**KANSAS CITY, MO**  
Benjamin Plaza - 9139 Hicrest • 765-5677  
Independence Center - 39th St. & I-70 • 735-0575  
Ward Parkway Mall - 84th & Ward Pky. • 444-1554  
Metro North Mall - Barry Rd. at Hwy 169 • 468-7477  
Blue Ridge Mall - Blue Ridge Blvd. at I-70 • 737-5533

**OKLAHOMA**  
Olathe, KS - Olathe Landing  
2006 E. Santa Fe • 769-7020

**OVERLAND PARK, KS** - Oak Park Mall  
95th at Quivra Lane • 599-5400

ITEMS MAY NOT BE EXACTLY AS ILLUSTRATED. NOT RESPONSIBLE FOR MISPRINTS OR TYPOGRAPHICAL ERRORS. ADVERTISED ITEMS LIMITED TO QUANTITIES ON HAND. WE RESERVE THE RIGHT TO LIMIT QUANTITIES. NO RAINCHECKS OR SUBSTITUTIONS.

SALES DATES NOVEMBER

SUN 24 MON 25 TUES 26 WED 27 THUR 28 FRI 29 SAT 30



# Savings



**SSIPS JUICE**  
10% Fruit Juice  
Rainbow or Red  
9 Pack

**1.99** Ea.  
SAVE 40¢



**CHRISTMAS CARDS**  
Assorted  
18 Count

**1.49** Ea.  
SAVE 50¢



**RITE AID COLOR PRINT FILM**  
135-24 Exposures,  
200 ISO

**1.99**  
SAVE \$1.00



**CHRISTMAS MILKY WAY OR SNICKERS MINIATURES**  
9 oz.

**2 FOR 3.00**  
SAVE 98¢ ON 2



**WHITMAN'S SAMPLER IN CHRISTMAS COLLECTOR TIN**  
14 oz.

**5.99**  
SAVE \$2.00



**JUMBO ROLL CHRISTMAS WRAPPING PAPER**  
36", 60 Sq. Ft. or  
EMBOSSED DOOR FOIL  
36", 21 Sq. Ft.

**1.99** Ea.  
SAVE \$1.00

For the Rite Aid Pharmacy nearest you, call 1-800-RITE-AID

**RITE**

**AID**

*For your life, Rite Aid's got it.*

# Pharmacy



At Rite Aid Pharmacy, our experienced pharmacists put technology to work to give you personalized service.

## State of the Art Caring.

**Rite Advice with every prescription.**  
The personalized safety information explains how to take your medication, and indicates possible side effects and potentially harmful drug interactions.

**Knowledgeable pharmacists.**  
Our pharmacists always take the time to answer your questions about your medicine and address your concerns about prescriptions or over-the-counter medications.

**Personal pharmacy records on file.**  
Rite Aid maintains a personal prescription history for each member of your family in our computer network.

**Convenient prescriptions, even while you travel.**  
With computer access to your prescription history at more than 2,800 locations, you get peace of mind from knowing we're here to help you meet your health care needs.

## Painless Prices



BRIMMS DENTURE BATH **1.49**  
SAVE 50¢

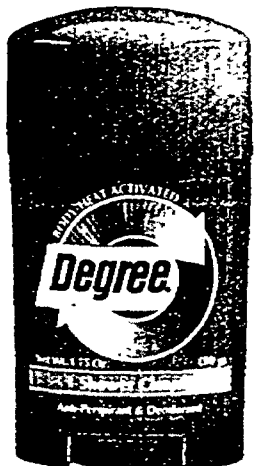

DEGREE SOLID Deodorant or Antiperspirant 1.75 oz-2.25 oz. **1.59**  
SAVE 40¢



REACH TOOTHBRUSHES Advanced Design or Wondergrip **1.99**  
SAVE 90¢

FDS Shower Fresh, Baby Fresh or Extra Strength 1.5-2.5 oz. **2.49**  
SAVE \$1.10

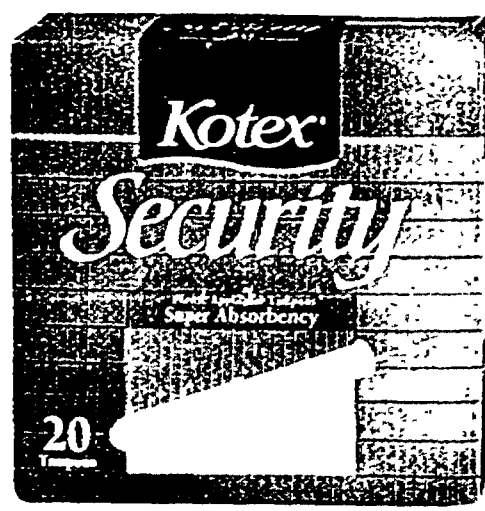

KOTEX SECURITY OR CURVED TAMPONS Regular or Super 18-22 Count **2.79**  
SAVE UP TO 80¢



EDGE AFTER SHAVE Sensitive Skin 3 oz. **2.99**  
SAVE 80¢

LISTERINE TOOTH PASTE Cool Mint or Cool Mint Gel 4.6 oz. **1.99**

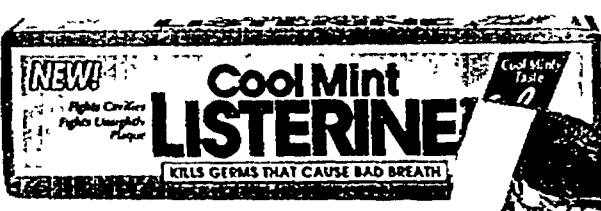

MAXIMUM STRENGTH



25% MORE FREE THAN 1.3 OZ. SIZE  
MAXIMUM STRENGTH GEL  
**Orajel**  
SAVE UP TO

ORAJEL Assorted Adult and Baby Formulas .3/16 oz. - .5 oz.

**25%** OFF REGULAR PRICE



GILLETTE GOOD NEWS! OR DAISY PLUS RAZORS 10 Count **3.69**  
SAVE UP TO \$1.10



BREATH ASURE 50 Count **3.99**  
SAVE UP TO 1.50¢

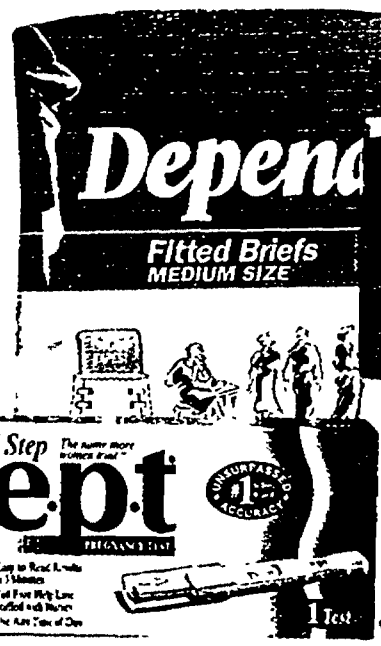

E.P.T. 1 STEP PREGNANCY TEST KIT Single Stick Test **9.99**  
SAVE UP TO \$3.40

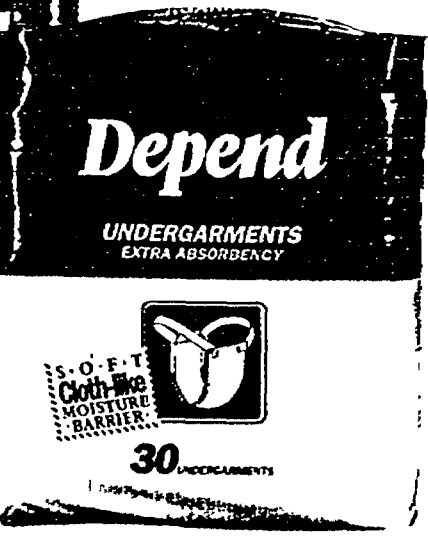

DEPEND Undergarments and Briefs 18-36 Ct. **14.49**  
SAVE \$2.50

CERTAIN ITEMS MAY NOT BE AVAILABLE IN ALL STORES • NOT RESPONSIBLE FOR TYPOGRAPHICAL ERRORS • WE RESERVE THE RIGHT TO LIMIT QUANTITIES



For your life, Rite Aid's got it.

# Cough & Cold

**NEW** Children's **Advil**  
CHILDREN'S ADVIL SUSPENSION  
4 oz.  
**4.49** SAVE \$1.60  
Fever Reducer Pain Reliever  
Lasts up to 8 Hours  
2 FL OZ (59 mL)

CHILDREN'S **TYLENOL**  
CHEWABLE TABLETS  
Fever Reducer/Pain Reliever  
CHILDREN'S **TYLENOL**  
CHEWABLE TABLETS  
Fever Reducer/Pain Reliever  
CHILDREN'S TYLENOL  
Chewable Tablets  
Reg. Grape or Bubblegum, 30's  
**2.49** SAVE \$1.00

**SUCRETS**  
REGULAR STRENGTH  
WILD CHERRY  
**SUCRETS**  
REGULAR STRENGTH  
WILD CHERRY  
SUCRETS  
Original, Assorted, Wild Cherry-18 Ct. or Maximum Strength Wintergreen-18 Ct.  
**2.29** SAVE UP TO \$1.40

**Ayr**  
... helps you breathe better  
FOR DRY, STUFFY NOSES  
**SALINE NASAL MIST**  
50-411 59 11 021  
AYR SALINE NASAL MIST 50 ml  
**2.39** SAVE \$1.00

**TRI-A-PHEN**  
EXPECTORANT SYRUP  
8 FL. OZ. (237 mL)  
**TRI-A-PHEN**  
EXPECTORANT SYRUP  
8 FL. OZ. (237 mL)  
TRI-A-PHEN SYRUP OR EXPECTORANT 8 oz.  
**1.99** SAVE UP TO \$2.30

**COMTrex**  
NON-DROWSY - NON DRYING  
LIQUID GELS OR TABLETS  
24 Count  
**COMTrex**  
NON-DROWSY - NON DRYING  
LIQUID GELS OR TABLETS  
24 Count  
COMTrex  
Non Drowsy Caplets, Day/Nite, Deep Chest Cold & Cough, Liquid Gels or Reg Tablets  
24 Count  
**4.59** SAVE \$1.40

**N'ICE**  
SUGAR FREE  
ASSORTED  
N'ICE LOZENGES  
Cherry, Assorted or Sugarless Orange  
16 Count  
**1.49** SAVE 90¢

**ACETAMINOPHEN PM**  
EXTRA STRENGTH  
RITE AID  
ACETAMINOPHEN PM  
Tablets or Caplets  
50 Count  
**1.99** SAVE UP TO \$2.40

**VICKS Vaporizer**  
1.5 Gallon #V150  
\$5.00 REFUND  
VICKS VAPORIZER 1.5 Gallon #V150  
**12.99** SAVE \$3.00

## Rite Aid Brands - Compare & Save

**Sudsy Ammonia**  
32 FL. OZ. (946 mL)  
**bleach**  
32 FL. OZ. (946 mL)  
RITE AID  
**2 FOR 99¢** SAVE 39¢ ON 2  
AMMONIA OR BLEACH 32 oz

**dish liquid**  
22 oz.  
**TOILET BOWL CLEANER**  
9 oz.  
RITE AID  
**99¢** Ea. SAVE UP TO 60¢  
DISH DETERGENT 22 oz.  
TOILET BOWL CLEANER 9 oz.

**fabric softener**  
64 oz.  
**laundry detergent**  
64 oz.  
RITE AID  
**1.99** Ea. SAVE UP TO \$1.00  
FABRIC SOFTENER OR LAUNDRY DETERGENT 64 oz.

**ANTACID**  
12 oz.  
**Liquid Antacid**  
12 oz.  
RITE AID  
**1.49** SAVE UP TO 80¢  
LIQUID ANTACID 12 oz.  
Antacid with Simethicone-12 oz

**Hydrocortisone Cream**  
1% Cream or Ointment  
1 oz.  
RITE AID  
**1.59** SAVE \$1.00  
HYDROCORTISONE 1% Cream or Ointment 1 oz.

**Backache Relief Caplets**  
48 Count  
RITE AID  
**1.99** SAVE UP TO \$1.50  
BACKACHE RELIEF Caplets or Tablets 48 Count

**SUPER STRENGTH DENTURE ADHESIVE**  
2.5 oz.  
RITE AID  
**2.49** SAVE 70¢  
SUPER STRENGTH DENTURE ADHESIVE 2.5 oz.

**WHITENING TOOTH PASTE**  
3 oz.  
RITE AID  
**3.99** SAVE \$1.00  
WHITENING TOOTH PASTE 3 oz.

**MAXI PADS**  
Regular or Super  
48 Count  
RITE AID  
**3.99** SAVE \$1.30  
MAXI PADS Regular or Super 48 Count

**HEATING PAD**  
THERMAL DIAL HEATING PAD  
14.99 SAVE \$4.00  
RITE AID  
**14.99** SAVE \$4.00  
THERMAL DIAL HEATING PAD

CERTAIN ITEMS MAY NOT BE AVAILABLE IN ALL STORES • NOT RESPONSIBLE FOR TYPOGRAPHICAL ERRORS • WE RESERVE THE RIGHT TO LIMIT QUANTITIES

*For your life, Rite Aids got it.*





# Beauty Care

why reapply?  
Just Press your lips.

And discover  
self-renewing color that  
wears on and on.

Ever wish you could be sure that your lipcolor  
stayed looking great for hours and hours?  
No problem!

Just press your lips and the unique  
formula with microbeads provides  
a fresh burst of color.  
So there's no need to reapply.



**Continuous Color  
Self-Renewing Lipstick**

**COVER GIRL**

- Continuous Color or Luminesse Lipstick
- Mascara, Assorted Types

**\$2.99**  
Ea.

**STETSON**  
\$11.95  
\$11.50  
PREFERRED STOCK  
**\$3.00**  
In Store Coupon  
Available on  
Gift Sets  
**7.99**

**REVLON  
GIFT SETS**  
Charlie #7677-25  
Charlie Red #9565 02  
Charlie White #7677-31  
Jontue #7677 04

SALE PRICE **9.99**  
IN STORE COUPON **-3.00**  
YOUR FINAL COST **6.99** Ea.

**DANA  
GIFT SETS**  
White Chantilly #18550  
Chantilly #12061  
French Vanilla #79174  
Tabu #164  
Dreams #22660  
Gardenia #460

SALE PRICE **11.99**  
IN STORE COUPON **-3.00**  
YOUR FINAL COST **8.99** Ea.

**NEW**  
Celebrate  
Celebrate  
**25% OFF**  
REGULAR PRICE

**CELEBRATE  
FRAGRANCES**  
Assorted Colognes, Sprays  
Body Powder or Lotion

**RITE AID  
WHITE  
BEAUTY  
BAR**  
WITH BATH OIL  
3 BATH SIZE BARS

**RITE AID  
SOAP**  
Green, Blue, or  
Beauty Bar  
3 Pack **99¢** SAVE 50¢

**CUTEX  
NAIL POLISH**  
Assorted Types  
& Shades

**1.79** Ea.  
SAVE 70¢

**OIL OF OLAY  
BEAUTY FLUID**  
Assorted Types  
4 oz

**6.49** Ea.  
SAVE 50¢

**Lubriderm  
LOTION**  
Assorted Types

**6.99** Ea.  
SAVE \$2.00

**CAPRI  
FOAM BATH**  
15 oz

**1.49**  
-1.00  
**49¢**

**RITE AID  
ANTIBACTERIAL  
LIQUID  
SOAP**  
16 oz

**1.49**  
SAVE 50¢

CERTAIN ITEMS MAY NOT BE AVAILABLE IN ALL STORES • NOT RESPONSIBLE FOR TYPOGRAPHICAL ERRORS • WE RESERVE THE RIGHT TO LIMIT QUANTITIES

*For your life, Rite Aids got it.*



# Beauty Care

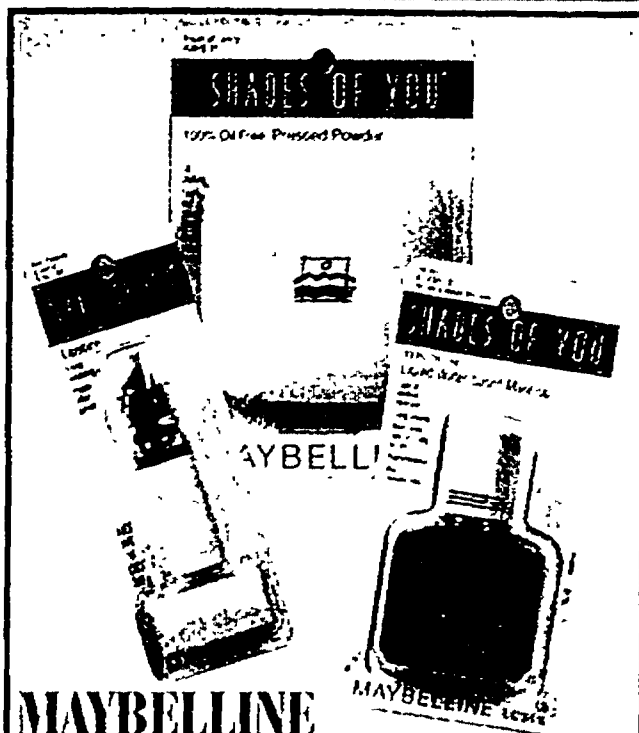

## MAYBELLINE SHADES OF YOU MAKEUP

• Liquid, Pressed Powder or Lipstick

**\$2.99** Each  
SAVE UP TO \$1.64

## MAYBELLINE SHADES OF YOU CREAM MAKEUP

• Assorted Colors

**\$3.99** Each



## a Sensitive Subject

Say goodbye to wimpy little lashes with Sensitique Gentle Lashbuilding Mascara. Wear contact lenses? Not a problem. The hypoallergenic formula is water-based and pH balanced, so even sensitive eyes aren't irritated. It's a kinder, gentler approach to amazingly full, long lashes. Who said you can't have everything?

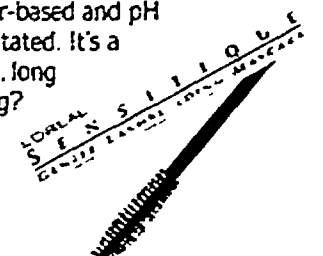

## L'OREAL

• Mascara, Assorted Types  
• Pencil Perfect or Le Grand Kohl Eyeliner

**\$3.99** Each

**AQUA NET HAIR SPRAY**  
Reg., Super, Extra Super or Ultimate Hold 7 oz.

**99¢** SAVE 50¢

**RITE AID Dual Care**  
FOR YOUR HAIR

**DUAL CARE SHAMPOO**  
Regular or Extra Body, 15 oz.

**1.99** SAVE 50¢

**THICKER FULLER HAIR**  
Hair Spray 8 oz, Shampoo or Conditioner 12 oz.

**3.99** SAVE UP TO \$1.00

**THICKER FULLER HAIR**  
SHAMPOO

**SALON SELECTIVES HAIR CARE**  
Shampoo or Conditioner-15 oz, Styling-7 oz.

**1.99** SAVE 60¢

**SALON SELECTIVES BOTANICAL BLENDS**  
CONDITIONER

**ISOPLUS HAIR CARE**  
Regular Oil Sheen Spray-11 oz, Spritz-8 oz, Wrapping & Setting Lotion 8 oz.

**1.99 to 2.99** Each

**OIL SHEEN HAIR SPRAY**

**CARE FREE CURL**  
Activator Reg. or Gold 8 oz, Moisturizer 8 oz, Lite Gel 11 oz

**2.69** Each SAVE UP TO \$1.50

**TCB NATURALS NO-LYE RELAXER KIT**  
Regular or Super

Relaxer Warning: Follow directions carefully to avoid skin and scalp irritation, hair breakage and eye injury.

**4.99** SAVE UP TO \$3.80

**AUSSIE HAIR CARE PRODUCTS**  
Assorted Shampoos, Conditioners, and Styling Products

**25% OFF REGULAR PRICE**

**MEGA STYLING SPRAY**

**CITRIFIER SHAMPOO**

**NO NONSENSE PANTYHOSE**

No nonsense Regular pantyhose

No nonsense Sheer to waist pantyhose

**2 FOR 3.00** SAVE UP TO \$1.98 ON 2

CERTAIN ITEMS MAY NOT BE AVAILABLE IN ALL STORES • NOT RESPONSIBLE FOR TYPOGRAPHICAL ERRORS • WE RESERVE THE RIGHT TO LIMIT QUANTITIES

*For your life, Rite Aids got it.*



# Candy Toys and Gifts Lights

**HAVILAND Thin Mints**  
7 oz. **69¢** SAVE 30¢

**MAXFIELDS BOXED CHOCOLATES**  
Assorted 16 oz. **1.99** SAVE \$1.00

**CHRISTMAS**  
CHOCOLATE FLAVORED CHRISTMAS BALLS OR BELLS  
7 oz. **3 FOR 2.00** SAVE 97¢ ON 2

**HERSHEY'S POT OF GOLD**  
Assorted Chocolates 14.1 oz. **3.99** SAVE \$2.96

**PRETTY HEART GLOW PONY**  
BATTERY OPER. HEART GLOW PONY

**PORCELAIN ANGEL**  
PORCELAIN ANGEL

**RESIN BOX**  
RESIN BOX

**RECIPZ SOUP MUG**  
RECIPZ SOUP MUG

**Mini Teapot**  
EARTHENWARE MINI TEAPOT

**PLAY'N BEAUTY SET**  
PLAY'N BEAUTY SET

**Yule Rite 35 miniature light set**  
Yule Rite 35 miniature light set

**YULE RITE CHRISTMAS LIGHT SET**  
Clear or Multi Colored 35 Count **2 FOR 2.99** SAVE 99¢ ON 2

- BATTERY OPER. HEART GLOW PONY
- PRECIOUS EXPRESSION DOLL
- MUSICAL STONWARE MUG
- GLASS VOTIVE HOLDER WITH STAND
- RECIPE SOUP MUG
- ASSORTED PORCELAIN GIFT ITEMS
- RESIN BOX

- EARTHENWARE MINI TEAPOT
- DECORATIVE GLASS BOTTLES
- SAFARI GANG ANIMALS
- CHRISTMAS DRESSED BEAR
- PLUSH ANIMAL IN TIN
- MINI VANITY TRAY
- WHITE PORCELAIN ANGEL

- PLAY'N BEAUTY SET
- POCKET FAMILY PLAYSET
- TOY HAIRCARE VANITY SET
- TOY BREAKFAST/DINNER SET
- RESIN DOG TRIO
- BRASS RING TIRE GAUGE
- BATTERY OPER. FAMOUS FIGHTER BUMP N' GO

**9.99 Each**

- 12" BATTERY OPER. TOW TRUCK
- BATTERY OPER. RACE SET
- WOOD BED TRAY
- PORCELAIN DOLL WITH MUSIC
- MUSICAL ASSORTMENT
- BERENSTEIN BEAR ASSORTMENT
- 21" DELUXE KANI BEAR
- 17" DRESSED BEAR

**Yule Rite 200 ct. Christmas light set**  
200 multi color mini light set

**YULE RITE 200 CT. CHRISTMAS LIGHT SET**  
Clear or Multi Color **5.99** SAVE \$2.00

**Yule Rite 140 computerized mini chaser lights**  
140 computerized mini chaser lights

**YULE RITE CHRISTMAS CHASER LIGHTS**  
Multi Color 140 Count **7.99** SAVE \$2.00

**HOLIDAY ORNAMENTS**  
Assorted **6 FOR 2.99**

**WHITE TREE SKIRT, WHITE TWINKLE MAT OR TRIPLE BELL GARLAND**  
**99¢**

**SCOTCH MAILING TAPE**  
Clear or Tan 2" x 800'  
**1.29** **1.00** **29¢**

**CERAMIC ANGEL, SILVERPLATED RING HOLDER, PERFUME ATOMIZER, ANGEL TEDDY FOR TRINKET BOX**  
**2.99** SAVE \$1.00

**ANGEL OR TINY ANGEL**  
**2 FOR 99¢** SAVE 75¢ ON 2

**MOUNTAIN PINE CHRISTMAS TREE**  
6'00"  
**9.99** SAVE \$3.00

**ASSORTED POLY EURO BAGS**  
**1.49** SAVE 50¢

**CURLING RIBBON 400' 3/16" OR GOLD BRAID CHRISTMAS STOCKING**  
**99¢** SAVE 50¢

**YULE RITE FLOCKED BOWS**  
3 Piece 5"  
6 Piece 4"  
12 Piece 2.5"  
**2 FOR 1.50** SAVE 48¢ ON 2

**MOBILE FLIP PHONE TOY, 45 PC. WORLD OR SPORTS CAR GAME**  
**2.99** SAVE \$1.00

**EXTENSION CORD, PRINTED STOCKING, CARD HANGING SET, PLASTIC BELL OR BELL TOP PILLAR CANDLE**  
**1.49** SAVE 50¢

**CHRISTMAS TISSUE 20 Sheets**  
**1.49** Ed. SAVE 50¢ **79¢**

CERTAIN ITEMS MAY NOT BE AVAILABLE IN ALL STORES • NOT RESPONSIBLE FOR TYPOGRAPHICAL ERRORS • WE RESERVE THE RIGHT TO LIMIT QUANTITIES.

*For your life, Rite Aid's got it.*



# Entertainment

## ELECTRONICS

## CAMERAS & FILM

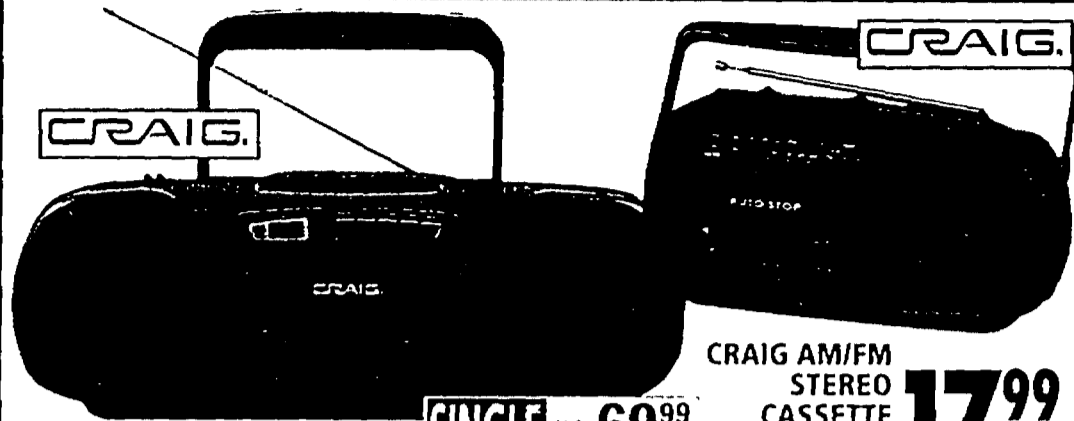

CRAIG COMPACT DISC AM/FM STEREO CASSETTE PLAYER #J58632

**SINGLE CHECK REBATE**  
RITE AID

69<sup>99</sup>  
-10<sup>00</sup>  
59<sup>99</sup>

CRAIG AM/FM STEREO CASSETTE RECORDER #J57211 **17<sup>99</sup>** SAVE \$2.00

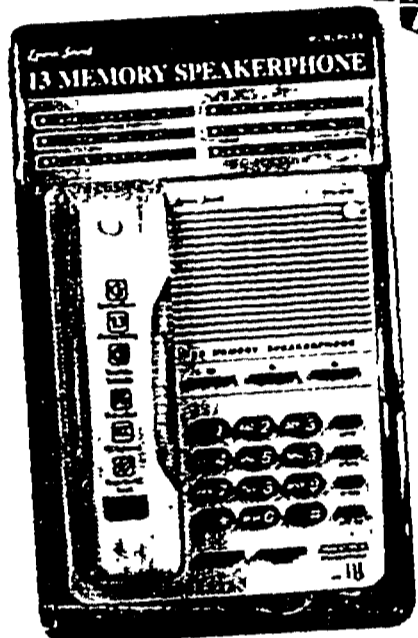

LENOXX SOUND MEMORY SPEAKER PHONE #PH319 **14<sup>99</sup>** SAVE \$5.00

LENOXX AM/FM STEREO CASSETTE RECORDER With Headphones #919 **9<sup>99</sup>** SAVE \$5.00



LENOXX PERSONAL STEREO CASSETTE PLAYER With Headphones #820 **7<sup>99</sup>** SAVE \$2.00

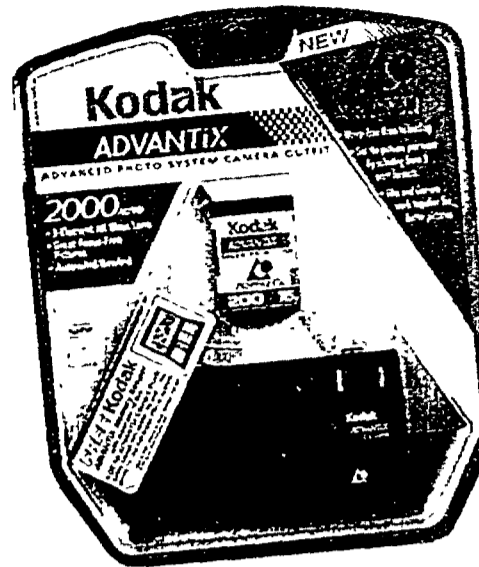

KODAK ADVANTIX CAMERA 2000 **69<sup>99</sup>** SAVE \$10.00

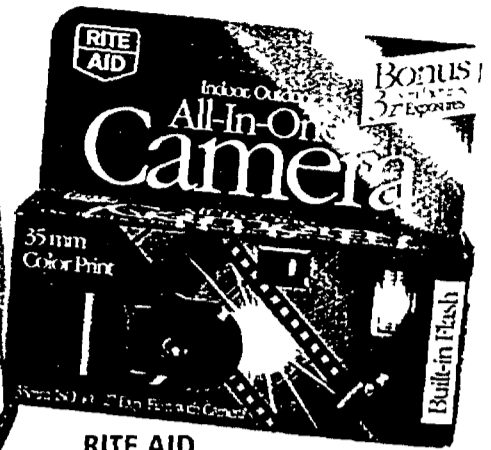

RITE AID ALL-IN-ONE SINGLE USE CAMERA With Flash 24+3 Exposures **5<sup>99</sup>** SAVE \$3.00



KODAK ADVANTIX FILM 200 Speed 25 Exposures **4<sup>29</sup>** SAVE \$1.50



KODAK GOLD COLOR FILM 135, 200 ASA 36 Exposures **8<sup>99</sup>** SAVE \$1.50



KODAK DISC FILM 2 Pack 30 Exposures **5<sup>99</sup>** SAVE \$1.00



TDK EHG VIDEO TAPE T-120 **2<sup>99</sup>** SAVE \$1.30



TDK VHS-C COMPACT VIDEO TAPE 2 Pack **7<sup>99</sup>** SAVE \$3.00

**SINGLE CHECK REBATE**  
RITE AID

4<sup>99</sup>



TDK D60 AUDIO TAPE 7 Pack **4<sup>99</sup>** SAVE \$1.00



GEMINI AUDIO TAPE 60 Minute 3 Pack **79<sup>99</sup>** SAVE 20¢



TAPE CASSETTE TOTE Holds 10 Cassettes **2<sup>99</sup>** SAVE \$1.00



DURACELL BATTERIES "C"-4 Pack "D"-4 Pack "9" Volt-2 Pack **3<sup>99</sup>**

## APPLIANCES

## HOUSEHOLD



TOASTMASTER CHOPSTER MINI FOOD CHOPPER Model #1111 **11<sup>99</sup>** SAVE \$3.00



TOASTMASTER COOL TOUCH TOASTER Model #B1023 **16<sup>99</sup>** SAVE \$3.00

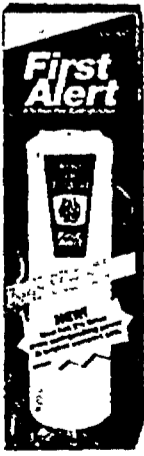

FIRST ALERT FIRE EXTINGUISHER **8<sup>99</sup>** SAVE \$4.00



ZEREX ANTIFREEZE COOLANT One Gallon **3<sup>99</sup>** SAVE \$2.00

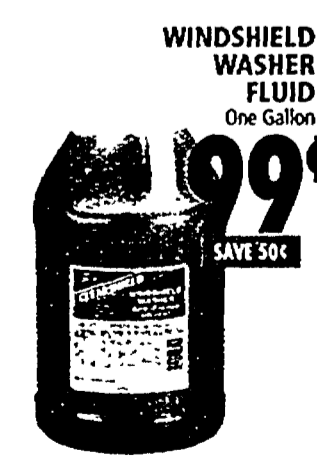

WINDSHIELD WASHER FLUID One Gallon **99<sup>99</sup>** SAVE 50¢



PURINA BEGGIN STRIPS 3 oz. **99<sup>99</sup>** SAVE 50¢

CERTAIN ITEMS MAY NOT BE AVAILABLE IN ALL STORES • NOT RESPONSIBLE FOR TYPOGRAPHICAL ERRORS • WE RESERVE THE RIGHT TO LIMIT QUANTITIES

*For your life, Rite Aids got it.*



# Holiday Savings

## WINE

**E & J GALLO**  
WINE  
Varieties White  
Zinfandel  
1.5 Liter  
**6<sup>99</sup>**



**GOSSAMER BAY WINE**  
Chardonnay or Zinfandel  
1.5 Liter  
**11<sup>99</sup>**

**KENDALL JACKSON WINE**  
Chardonnay  
750 ml  
**11<sup>99</sup>**



**SEAGRAM'S COOLERS**  
Assorted Flavors  
4 Pack

**2 FOR 7<sup>00</sup>**  
Plus Deposit

**FRANZIA**  
White Cabernet  
5 Liter

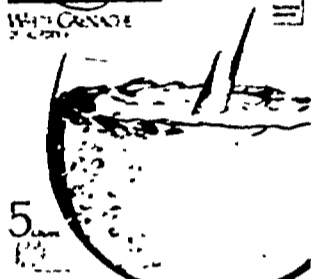

**FRANZIA BOX WINE**  
White Cabernet, Chablis or Blush  
5 Liter  
**8<sup>99</sup>**

## SPIRITS



**SMIRNOFF VODKA OR BACARDI LIGHT RUM**  
80 Proof  
750 ml  
**9<sup>95</sup>**  
Eo.



**SEAGRAMS 7 CROWN WHISKEY**  
750 ml  
**10<sup>45</sup>**

## BEER & SODA



**12 PACK**  
**MOLSON ICE BEER**  
12 Pack  
12 oz. Bottles  
**7<sup>49</sup>**  
Plus Deposit



**OLD MILWAUKEE BEER**  
Regular or Light  
24 Pack  
12 oz. Cans  
**8<sup>99</sup>**  
Plus Deposit



**MILLER BEER**  
Reg., Lite, Genuine Draft, Genuine Draft Light or Ice  
24 Pack  
12 oz. Cans  
**13<sup>69</sup>**  
Plus Deposit



**COKE, DIET COKE, OR SPRITE**  
2 Liter Bottle  
**99<sup>¢</sup>**  
Plus Deposit



**TROPICANA FRUIT JUICE**  
Orange, Grapefruit or Apple  
32 oz.  
**1<sup>19</sup>**  
SAVE 50¢



**ORTEGA THICK AND CHUNKY SALSA**  
Mild or Medium  
12 oz.  
**1<sup>29</sup>**  
SAVE 50¢



**HUNGRY JACK MASHED POTATOES**  
Cheese or Sour Cream & Chives  
18 Servings  
13.3 oz.  
**1<sup>29</sup>**  
SAVE 50¢



**PLANTERS WHOLE FANCY CASHEWS**  
10 oz.  
**3<sup>99</sup>**

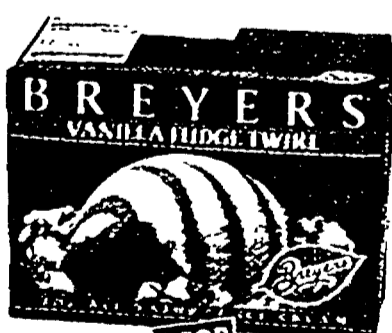

**2 FOR 7<sup>00</sup>**  
**BREYERS ICE CREAM**  
Assorted Flavors  
1/2 Gallon  
SAVE \$1.50 ON 2

### RITE AID Valuable Coupon

**4" JUMBO DOUBLE PRINTS**  
**\$5<sup>99</sup>**  
only

**or**

**3" DOUBLE PRINTS WITH FREE FILM**  
**\$5<sup>99</sup>**  
only

**TO REDEEM:**

1. Check "Coupon Enclosed" box on order envelope.
2. Check off 4" or 3" Double Prints box on Rite Aid Quality Processing side of order envelope.
3. Enclose coupon and film into envelope.

Offer good on develop and printing of original color print roll. One roll per coupon. Original coupon must accompany order. Not valid with panoramic, Advanced Photo System processing print or KODAK Mailers. Not valid on 1 hour processing orders. Coupon expires 12/31/96.

**RITE AID Rite Aid Photo Center**

For the Rite Aid Pharmacy nearest you, call 1-800-RITE-AID

CERTAIN ITEMS MAY NOT BE AVAILABLE IN ALL STORES • NOT RESPONSIBLE FOR TYPOGRAPHICAL ERRORS • WE RESERVE THE RIGHT TO LIMIT QUANTITIES.

*For your life, Rite Aid's got it.*





**TWELVE-HOUR SALE**  
**Thursday only!**  
**8 a.m. to 8 p.m.**

Auto-lock pull-handle system  
 2-way hanging system

**THURSDAY ON**  
**3999**

**Wheeled garment bag**  
 • 23"Hx20"Wx7"D or 22"Hx14"Wx7"D  
 • Interior mesh pockets  
 Reg 69.99-79.99 Save \$30-\$40

Two zippered pockets on front panel  
 Wide base wheels

**499 THURSDAY ONLY**

**Sale! Ultra Tide laundry detergent**  
 • 100-oz liquid  
 • 33-42-use powder

**THURSDAY ONLY**  
**2/\$3**

**Sale! Choice of nuts**  
 • Large cashew pieces  
 • Mixed nuts  
 • 9 oz net wt

**THURSDAY ONLY**  
**179**

**Sale! Choice of cereal**  
 • 15 oz \* Cheerios 14.25 oz \* Frosted Cheerios or 14 oz \* Honey Nut Cheerios  
 • 12-oz \* Trix

DATE IMPRINT  
 Self timer  
 Automatic flash with red eye reduction

**THURSDAY ONLY!**  
**8999**

**Canon Sure Shot 60 Zoom QD camera**  
 • 38 60mm auto-focus zoom lens  
 Reg 139.99 Save \$50

SAVE 50%

**THURSDAY ONLY!**  
**2499**

**Minolta Freedom 35R-FF 35mm camera**  
 • Focus-free wide-angle 28mm lens  
 Reg 49.99. Save \$25

Auto-motorized film advance/rewind

**THURSDAY ONLY**

**Home**

Including trees, stands, animated figures, tree skirts, garland, light sets, outdoor decorations, electronic tabletop decorations, wreaths  
 \*Reduction is off reg prices

Daewoo

On screen display menu  
 Built in closed caption  
 Commercial scan  
 Convenient sleep timer  
 181 channel tuning system

**14999 THURSDAY ONLY**

Save \$20 on a Daewoo 19" color TV  
 • Programmable channel skip memory, 19" diag measure  
 Reg 169.99 Save \$20  
 GE 4-head VCR, Reg 179.99, Sale 149.99  
**All Other TVs And VCRs On Sale**

BUY 1 GET 1 FREE

**THURSDAY ONLY**  
**599**

**Mini boom box**  
 • AM FM radio w/ dual speakers  
 • Retractable antenna  
 Reg 7.99 Save \$2

**THURSDAY ONLY**  
**40% off**

**All ladies' and men's outerwear**  
 • Ladies' sizes S-L  
 • Men's sizes S-XL  
 Reduction Is Off Reg Prices

SPORTCRAFT

SAVE 50%

**2999 THURSDAY ONLY**

**Electronic dart board**  
 • Regulation 18" soft-tip board  
 • Automatic scoring for 4 players  
 Reg 59.99 Save \$30

**399 THURSDAY ONLY**

**Sale! Live poinsettias**  
 • Red, white or pink  
 • Minimum 5 blooms  
 • In 6" pots

★ Open Thanksgiving Day 8 AM-8 PM;  
 Friday 6 AM-11 PM; Saturday 8 AM-11 PM

**Super Market**

**Twelve-hour Sale**  
**Thanksgiving Day**  
 8 a.m. to 8 p.m.

**Super Market**

Thursday, November 28  
**Thanksgiving Day only!**  
**12-hour Special Event**  
 Open Thursday, Thanksgiving Day 8 a.m.-8 p.m.

© 1994 JOE'S 1128 GSPADA AND 1AAA (2 & 4 5 & 7 & 8 & 10 14 & 17 & 20) JOE'S 1128 GSPADA PRINTED IN THE USA

© 1994 JOE'S 1128 GSPADA AND 1AAA (2 & 7 8) JOE'S 1128 GSPADA

# HURRY IN FOR OUR Thursday only

# TWELVE-HOUR SALE 8 a.m. to 8 p.m.



Adjustable function knob

Stainless steel filter

**THURSDAY ONLY!**  
**24.99**

**Kitchen Basics Espresso/Cappuccino maker**

- Froths milk, heats beverage
- Reg. 29.99. Save \$5



**Rego**

**THURSDAY ONLY!**

**SAVE 50%**



**THURSDAY ONLY!**

**50% off**

**Men's silk boxers**

- Varied styles
- Reg. 9.99. Sale 4.99
- Men's Silk Briefs, Reg. 5.99. Sale 2.99

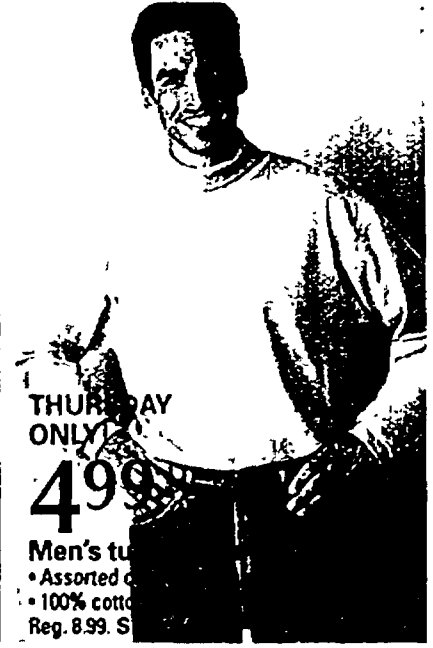

**THURSDAY ONLY!**

**4.99**

**Men's t-shirt**

- Assorted colors
- 100% cotton
- Reg. 8.99. Sale 4.99



**19.99** 5 stackable trays

**Kitchen Basics food dehydrator**

- 300-watt ceramic heater with fan
- Easy to clean
- Reg. 24.99. Save \$5



Dual-level steaming

**THURSDAY ONLY!**

**19.99**

**Kitchen Basics food steamer**

- Cooks two dishes at the same time
- Easy to clean
- Reg. 24.99. Save \$5



**THURSDAY ONLY!**

**25% off**

**Entire stock of watches**

- Choose from dress, sport, fashion or character watches
- Reduction is Off Reg. Prices



**LEATHER**

**WIDE WIDTH**

**SAVE 50%**

**THURSDAY ONLY!**

**1/2 off**

**Women's leather mocs**

- Cushioned comfort insole
- In wide width sizes
- Reg. 14.99. Sale 7.49



**THURSDAY ONLY!**

**4.99**

**Twin/full-size print blankets**

- Available in assorted floral, southwest or animal prints
- Reg. 7.99. Save \$3



Extra-large view window

7 bread settings

**SAVE \$21**

**THURSDAY ONLY!**

**68.99**

**Breadman 1.5-lb. breadmaker**

- Fruit and nut add-in beeper
- Preprogrammed for delay baking
- Reg. 89.99. Save \$21



**THURSDAY ONLY!**

**50% off**

**Girls' printed vests**

- First holiday print
- Varied styles
- Reg. 1.99. Sale .99



**Hanes HerWay**

**THURSDAY ONLY!**

**3.49**

**Sale! Ladies' Hanes HerWay 3-pack panties**

- Briefs, bikinis or brief cuts



**THURSDAY ONLY!**

**5.99**

**Twin-size sheet sets**

- Assorted print patterns
- Reg. 7.99. Save \$2
- Full, Sale 12.99, Queen, Sale 16.99



**SAVE 40%**

**THURSDAY ONLY!**

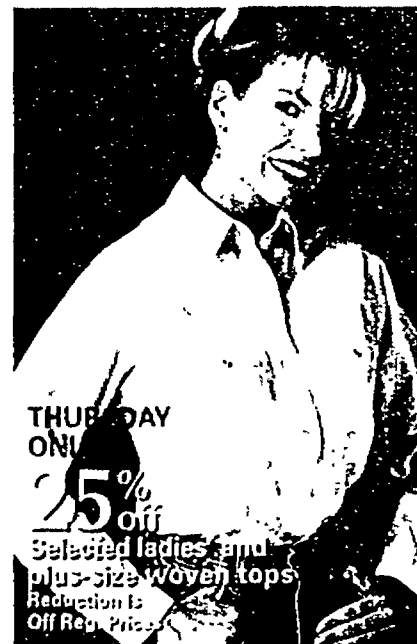

**THURSDAY ONLY!**

**25% off**

**Selected ladies and plus-size woven tops**

- Reduction is Off Reg. Prices

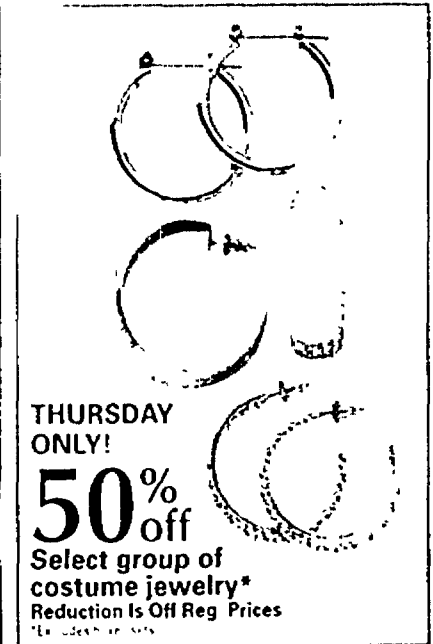

**THURSDAY ONLY!**

**50% off**

**Select group of costume jewelry\***

- Reduction is Off Reg. Prices



**SAVE 50%**

**THURSDAY ONLY!**

**29.99**

**Tasco binoculars**

- 10x50m Zip<sup>®</sup> focus
- Wide-angle view - 367 ft./1,000 yds
- Reg. 59.99. Save \$30



9 volt battery included

**AMERICAN SENSORS**

**SMOKE & FIRE DETECTOR**

General Purpose

Alarm and power-test buttons

Low battery warning

**3.99 THURSDAY ONLY!**

**Sale! Smoke/fire detector**

- UL approved
- 10-year warranty
- Reg. 5.99. Save \$2



Filled & location Dalmatian attraction Disney V

**THURSDAY ONLY!**

**2/\$9**

**Infants' toddlers' fleece sets**

- Varied styles
- Polyester/cotton or acrylic
- Reg. 6.44-7.44



**THURSDAY ONLY!**

**6.99**

**Men's 4- or 5-pack briefs**

- Hang Ten or Britanna
- Solids or prints
- Reg. 9.99. Save \$3

Today's  
Kmart



LOOK INSIDE:  
THREE-DAY SALE  
Thursday, Friday  
and Saturday

HURRY IN FOR  
**5 Hours of  
amazing savings!**

**FIVE-HOUR SALE  
Friday only!  
6 a.m. to 11 a.m.**

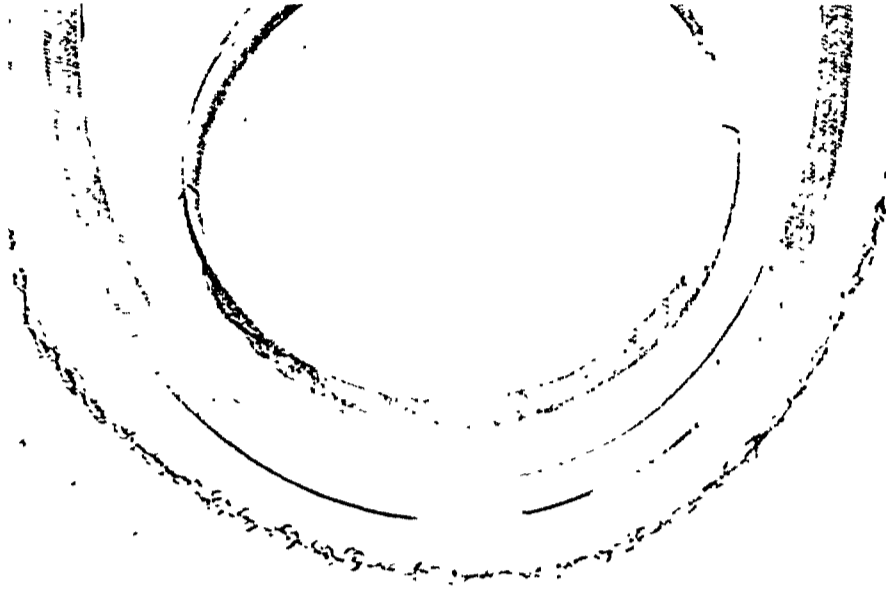

**70% off**

All 10- & 14-kt. gold,  
sterling silver, diamond,  
colorstone and  
cubic zirconia jewelry

Excludes jewelry with pearls. Applies to retail merchandise only. While quantities last. Cash or check only. Minimum \$400 available per store.

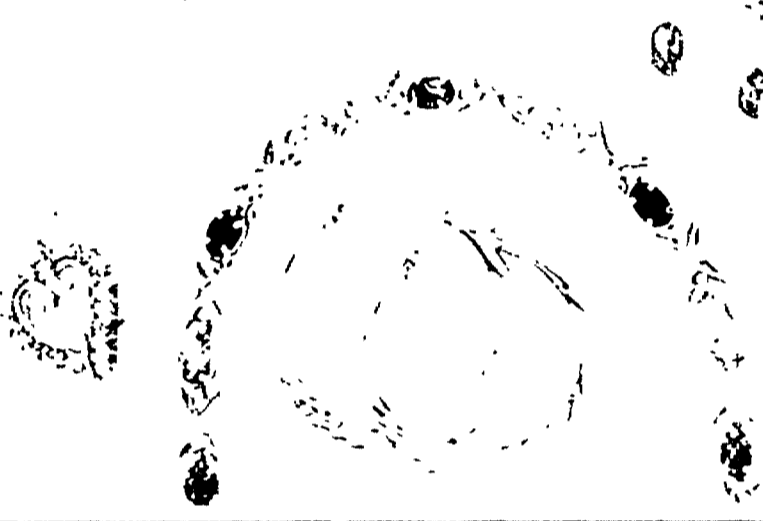

6-11 a.m.  
**Friday Only**  
**29.99**  
1.0-ct. T.W.\*  
**diamond tennis  
bracelet\*\***  
Reg 99.99 Save \$70

\*Represents total diamond weight between .50 to 1.00 carats. \*\*Actual diamonds while quantities last. Sorry, no cash checks. Minimum \$500 store.

**2.99** 6 AM-11 AM  
FRIDAY ONLY  
**Christmas CD with card**  
• Special selection of holiday favorites  
• Includes envelope  
While quantities last. Sorry, no cash checks. Minimum \$200 available per store.

**5.79** 6 AM-11 AM  
FRIDAY ONLY  
**Sale! Folger's coffee**  
• 39 oz. auto drip or reg. perc.  
• 36 oz. Col'ombian or 26 oz. decaf  
While quantities last. Sorry, no cash checks. Minimum \$200 available per store.

**39.99** 6 AM-11 AM  
FRIDAY ONLY  
**16" or 20" Roadmaster bike**  
• Boys' "Street Action" or girls' "Starlit"  
Reg 49.99 Save \$10  
Professionally Assembled. 49.99  
While quantities last. Sorry, no cash checks. Minimum \$200 available per store.

6-11 a.m.  
**Friday Only**  
**10% off**  
All CDs,  
cassettes and  
prerecorded  
movies  
Reduction Is Off Reg. Prices  
Excludes sale priced items

**2/\$11** 6 AM-11 AM  
FRIDAY ONLY  
**Value Plus  
twin/full-size blankets**  
• Blue, ivory or pink  
• Polyester  
Reg 4.99 Ea

**9.99** 6 AM-11 AM  
FRIDAY ONLY  
**71" halogen  
torchiere floor lamp**  
Reg 14.99 Save \$5  
**30% Off\* All Lamp  
Bases And Shades**  
Buy 1 lamp or lamp base. \*Excludes shades. While quantities last. Sorry, no cash checks. Minimum \$200 available per store.

**2/\$11** 6 AM-11 AM  
FRIDAY ONLY  
**Sale! Masterpiece  
boxed chocolates**  
• Assorted chocolates  
• 3 lb.-net-wt. box  
• A sweet gift idea

6-11 a.m.  
**Friday Only**  
**20% off**  
All toys\*  
Reduction Is Off Reg. Prices  
\*Excludes bikes

**SAVE 50%**  
Sale 4.49  
**1/2 off** 6 AM-11 AM  
FRIDAY ONLY  
**Men's and women's slippers**  
• Men's suede leather moccasins  
• Women's clog scuffs in natural and pink  
Reg 8.99-9.99 Sale 4.49-4.99

6 AM-11 AM  
FRIDAY ONLY  
**3.99**  
**Sale! Ladies' and  
men's fleece**  
• Polyester/  
cotton, S-XL

**99¢** 6 AM-11 AM  
FRIDAY ONLY  
**Closeout! Computer software**  
• CD-ROM, 3.5" or 5.25" disk software  
Our \$2 CD-ROM Software, Sale 1.69  
While quantities last. Sorry, no cash checks.  
Minimum \$200 available chainwide.



**FREE 101 DALMATIANS GIFT BAG**  
to the 1st 500 customers  
who enter Kmart Fri., Nov. 29 from 6 a.m. to 11 a.m.

This great gift includes a Dalmatians poster, color book, stickers  
and trading cards! Plus an assortment of snack treats!

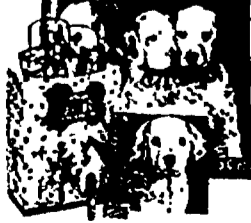

**Super  
Kmart**

**SALE PRICES ON THIS PAGE  
EFFECTIVE FRI., NOV. 29, 6 AM-11 AM**  
Store hours Fri., Nov. 29, 6 a.m.-11 p.m.  
Most Super Kmart stores open 24 hrs. All merchandise advertised in this  
circular is available at your local Kmart or Super Kmart.



**FIVE HOUR SALE**  
**Friday only! 6 a.m. to 11 a.m.**

**6.99**  
**6 a.m.-11 a.m. FRIDAY ONLY**  
**14.99**  
**Kids' Crayola® pilot case**  
 • Durable PVC material, 12"x16"x5 1/2" size  
 Reg. 19.99. Save \$5  
 Crayola® Duffel, Reg. 9.99, Sale 6.99

**SAVE 44%**  
**6 a.m.-11 a.m. FRIDAY ONLY**  
**14.99**  
**Men's MacGregor wind sets**  
 • 2-piece 100% nylon sets  
 • Zip-front lined jacket with pockets  
 Reg. 26.99. Save \$12

**6 a.m.-11 a.m. FRIDAY ONLY**  
**\$3**  
**Infants', toddler blanket sleepers**  
 • Assorted colors  
 Reg. 4.99. Save 1.99

**17.49**  
**4.89**  
**6 a.m.-11 a.m. FRIDAY ONLY**  
**30% off**  
**Rubbermaid® totes**  
 10-gal. tote, Reg. 5.99, Sale 4.19  
 18-gal. tote, Reg. 6.99, Sale 4.89  
 50-gal. tote, Reg. 24.99, Sale 17.49

**WEAVER**  
**SAVE \$30**  
**Blue porcelain finish is chip and scratch resistant**  
**49.99**  
**6 a.m.-11 a.m. FRIDAY ONLY**  
**13-pc. Impressions cookware set**  
 • 1- and 2-qt. covered saucepans, 8" and 10" saute pans  
 • 5-qt. covered Dutch oven, 12" covered saute pan, 3 utensils  
 Reg. 79.99. Save \$30  
 7 yr. warranty

**3 MIN SERIES**  
**6 a.m.-11 a.m. FRIDAY ONLY**  
**2.99**  
**Men's 3-pack briefs**  
 • Sizes 30-44  
 Reg. 4.79. Save 1.80  
**Boys' 3 pack Briefs, Sale 2.49**

**Exclusively at Kmart!**  
**6 a.m.-11 a.m. FRIDAY ONLY**  
**9.99**  
**64-pc. Pop-Top storage set**  
 • Microwave, freezer and dishwasher safe  
 • Perfect starter set  
 Reg. 15.99. Save \$6

**6 a.m.-11 a.m. FRIDAY ONLY**  
**11.77**  
**Playtex bras**  
 • 18 Hour or underwire styles  
 Reg. 13.87-18.75. Save 2.10-6.98  
 Cross Your Heart Styles. Sale 7.77

All Impressions Open-stock Cookware, Sale 9.99

**PHILCO**  
**6 a.m.-11 a.m. FRIDAY ONLY**  
**6.99**  
**AM/FM clock radio**  
 • Mini boom box; detachable speakers  
 • LCD alarm clock  
 Reg. 9.99. Save 3.00

**6 a.m.-11 a.m. FRIDAY ONLY**  
**2/79.99**  
**2-way handheld radio**  
 • 40-channel operation, detachable antenna  
 • Includes belt clip, cigarette lighter plug  
 Reg. 69.99. Sale 2/79.99

**6 a.m.-11 a.m. FRIDAY ONLY**  
**3/\$2**  
**Northland firelog**  
 • 3 lb log  
 Reg. 99¢ Ea  
**6 log Case, Reg. 5.99, Sale 3.99**

**30% OFF**  
**Rebate!**  
**600**  
**6 a.m.-11 a.m. FRIDAY ONLY**  
**19.99**  
**3-pack Polaroid 600 instant film**  
 • 2 packs of 10, plus 6 bonus pictures  
 Reg. 20.99

**6 a.m.-11 a.m. FRIDAY ONLY**  
**2.49**  
**14.99**  
**Sale! Polaroid One-Step instant camera**  
 • Automatic built-in flash, focus-free lens  
 • Closeup switch for closeup shots  
 Rebate needed to receive instant pictures

**6 a.m.-11 a.m. FRIDAY ONLY**  
**39.99**  
**Sale! Kodak Cameo Motor EX instant camera kit**  
 • Special Olympic Edition camera kit  
 • 35mm camera, 1 roll of 24-exp ISO 400  
 Royal Gold film and bonus camera bag

**SAVE \$14**  
**6 a.m.-11 a.m. FRIDAY ONLY**  
**14.99**  
**Perfect golf cart**  
 • Lightweight steel construction  
 Reg. 28.99. Save \$14

**6 a.m.-11 a.m. FRIDAY ONLY**  
**9.99**  
**Youths' sleeping bag**  
 • 28x66" size  
 • Full-length zipper  
 Reg. 12.99. Save \$3

**6 a.m.-11 a.m. FRIDAY ONLY**  
**2/4.50**  
**Sale! "Grand Slam" cotton bath towels**  
 Hand Towel, Sale 2/3.50  
 Washcloth, Sale 2/2.50  
**25% Off\* Grand Slam Bath Rugs**  
 \*Reduction in reg. prices

**6 a.m.-11 a.m. FRIDAY ONLY**  
**29.99**  
**5-pc. tray table set**  
 • 4 natural-finish tables; solid wood tops  
 • Includes tray stand  
 Reg. 49.99. Save \$20  
 Styles may vary

**6 a.m.-11 a.m. FRIDAY ONLY**  
**64.99**  
**Samsung 600-W microwave**  
 • 0.5 cu.-ft. oven capacity  
 • Mechanical controls; rotating turntable  
 Reg. 79.99. Save \$15  
 MC2550W

**THREE DAY SALE**  
**Thursday, Friday & Saturday**

**9.99**  
**Hooded tops**  
 • Acrylic fleece  
 Reg. 12.99-14.99. Save \$3-\$5  
**Lined Hooded Tops**  
 Reg. 19.99. Sale 14.99  
**Nylon Pants**  
 Reg. 9.99-11.99. Sale 8.99

**ENTIRE STOCK OF MEN'S FLANNEL SHIRTS OR JEANS**  
**Buy 1, get the 2nd 1/2 PRICE**  
 Buy one flannel shirt or pair of jeans at the regular price, get the second (of equal or lesser value) at 50% off the regular price

**6.49**  
**Basic Editions™ cotton jersey**  
 • 3-button styling  
 Reg. 9.99. Save 3.50  
**SAVE 35%**

**12.99**  
**Men's fleece tops**  
 • Zip or hooded styles  
 Reg. 18.99. Save \$6

**ROUTE 66**  
**ESP**  
**BRITANIA**

**9.99**  
**Heavyweight cotton shirts**  
 • Thermal or ribbed  
 • Henley or polo styles  
 Reg. 14.99. Save \$5  
**NORTHWEST TERRITORY**

**20% off**  
**All men's activewear**  
 • MacGregor®, Wilson, Franklin  
 • Assorted styles  
 Reduction in Off Reg. Prices

**5.49**  
**4.49**  
**Men's Fruit Of The Loom activewear**  
 • Cotton t-shirts or pants  
 Reg. 6.49. Sale 4.49  
**With Rebate**  
**Big Men's 2X-3X Sale 7.49\***  
**20% Off Reg. Prices**

**14.99**  
**Men's corduroy jeans**  
 • 100% cotton  
 Reg. 18.99. Save \$4

SALE PRICES ON THIS PAGE EFFECTIVE FRIDAY, NOVEMBER 29, 6 AM-11 AM

SALE PRICES ON THIS PAGE EFFECTIVE THURSDAY, NOVEMBER 28, 29, 30

# 3 Day Sale! Thursday,

**Buy one sweater get the second sweater at 1/2 price**

Photographed at the 101 Dalmatians attraction at Walt Disney World

**All ladies' and men's sweaters**  
Buy one ladies' or men's sweater at the regular price, get the second (of equal or lesser value) at 50% off the regular price.



**9999**

**Leather jackets**  
• Double breasted  
• Attached tie belt  
Reg 159.99  
Save \$60



**1699**  
**Jaclyn Smith® velour separates**  
• Button-front, crew-neck or top-neck tunics  
• Pull-on pants  
• Polyester/cotton  
Reg. 24.99  
Save \$8

**1199**  
**Jaclyn Smith® separates**  
• Polyester/cotton  
• Fleece  
• Varied styles  
• Sizes S-XL  
Reg. 16.99  
Save \$5

**1999**  
**Ladies' 2-piece wind sets**  
• Fully lined jackets and pants  
• Quilted trim  
• 100% nylon  
Reg. 29.99  
Save \$10

**1499**  
**Holiday cotton fleece tops**  
Reg 19.99 Save \$5  
Polyester/cotton  
Fleece Tops, Reg. 14.99-16.99  
Sale 9.99-12.99  
Legging Styles, Reg. 18.99, Sale 12.99

**799**  
**Ladies' screen tees**  
• Assorted prints  
• 100% cotton  
Reg. 9.99-10.99  
Save \$2-\$3

**Buy 1 pair ladies' jeans, get the 2nd pair 1/2 price\***  
Buy one pair of ladies' jeans at the regular price and get the second pair (of equal or lesser value) at 50% off the regular price.  
\*Applies to in-store merchandise only.

- Chic®
- Brittonia
- Route 66®
- Bon Jour

**499**  
**Ladies' turtlenecks**  
Reg. 6.99-7.99 Save \$2-\$3  
Nutcracker Plus-size Mocknecks, Sale 6.99  
Basic Editions™ Plus-size Mocknecks, Reg. 6.99, Sale 5.99

**2/\$15**  
**Ladies' wind pants**  
• 100% nylon shell, zip ankle  
• Polyester/cotton lining  
Reg. 9.99 Ea

**1499**  
**Split-leather handbags**  
• Assorted styles and colors  
• Some with organizer features  
Reg. 19.99, Save \$5  
**25% Off\* All Other Leather Handbags**  
\*Reduction is off reg. prices

**899**  
**Ladies' handbag gift sets**  
Reg. 12.99 Save \$4  
**25% Off Reg. Prices On Men's And Ladies' Wallet Gift Sets**

SALE PRICES ON THIS PAGE EFFECTIVE NOVEMBER 28, 29, 30

# Friday & Saturday



**2399**

**Cubic Zirconia "S"-link bracelet**  
 • Set in 23-kt. gold-over-sterling silver  
 • 7" length  
 Reg 59.99 Save \$36



Save \$150 on  
**heart pendant**  
 with 5-looks-in-1  
**9999**

**SAVE 60%**

5 looks with the purchase of one heart pendant  
 • Set in 10-kt. gold  
 • Reversible ruby with diamond accent  
 Reg 249.99 Save \$150

**55% Off\*** Selected **Diamond, Color Stone, Cubic Zirconia, 10-kt.-And 14-kt.-Gold And Sterling Silver Jewelry**  
\*Reduction is off reg. prices

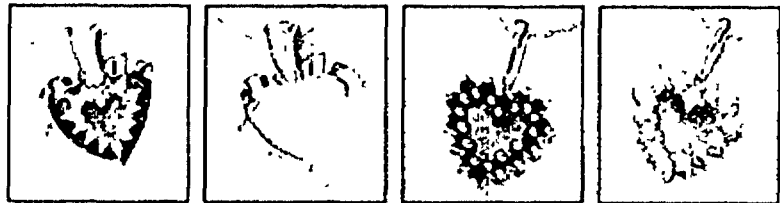
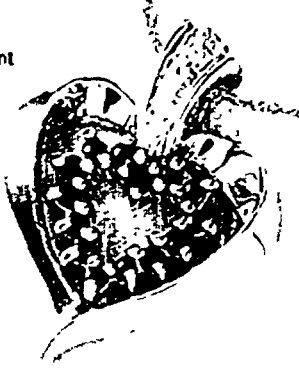

LOOK WHAT'S **NEW** AT K-MART

**6999**

**1.0-ct. T.W.\* diamond tennis bracelet\*\* set in 10-kt. gold**  
 Reg. 99.99. Save \$30  
\*Represents a total diamond weight between .96-1.08 \*\*Rose diamonds



**9999**

**SAVE 66%**

**10-kt. gold panther bracelet**  
 • 7" length  
 Reg 299.99 Save \$200



**5999**

**SAVE 70%**

**10-kt. gold X-O bracelet**  
 • Hearts and kisses  
 • 7" size  
 Reg 199.99 Save \$140



**15999**

**SAVE 73%**

**14-kt. gold necklaces**  
 • Leach & Garner gold  
 • 5mm herringbone  
 • Rope chain  
 Reg 599.99 Save \$440

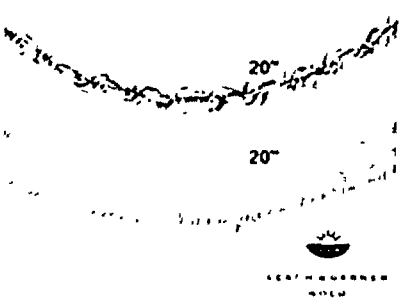

**55% off**

**Boxed gold pendants**  
 Reduction is off reg. prices

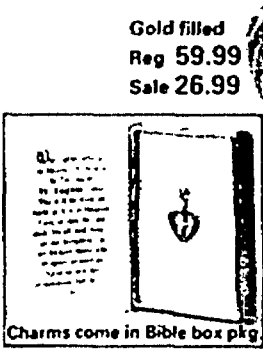

Gold filled  
 Reg 59.99  
 Sale 26.99

10-kt. Gold  
 Reg 99.99  
 Sale 44.99

10-kt. Gold  
 Reg. 139.99  
 Sale 62.99

**2/4998**

**Choice of any 2 pairs of 10-kt. gold hoop earrings**  
 • Assorted styles and finishes  
 Reg. 59.99 Ea. Save \$35 Ea.

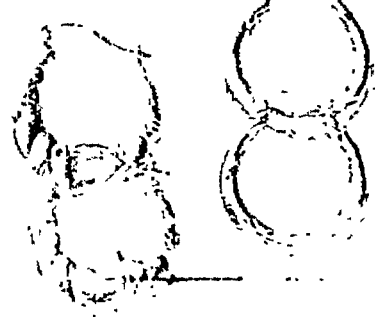

**5399**

**Your choice! Ruby pendant or earrings in 10-kt. gold**  
 • Diamond accents  
 Reg 119.99-139.99 Save \$68-\$86



**19999**

**SAVE 60%**

**2.0-ct. T.W.\* diamond tennis bracelet\*\* set in 10-kt. gold**  
 Reg 499.99 Save \$300  
\*Represents a total diamond weight between 1.96-2.18 \*\*Rose diamonds



**3499**

**SAVE 65%**

**14-kt. gold oval hoop earrings**  
 • Diamond satin finish  
 Reg 99.99 Save \$65

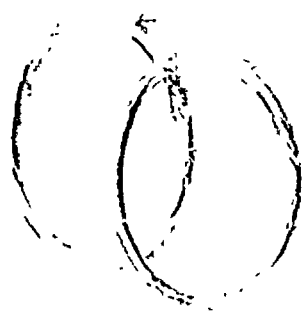

**1499**

**SAVE 62%**

**Sterling silver trio hoop earrings**  
 • Traditional designs  
 Reg. 39.99 Save \$25



**25% off**

**Boxed costume jewelry**  
 • Assorted festive styles  
 • Great for gift giving  
 Reduction is Off Reg. Prices



**25% off**

**All Armitron® watches**  
 • Sport, dress and character styles  
 • Includes bonus 35mm camera  
 Reduction is Off Reg. Prices

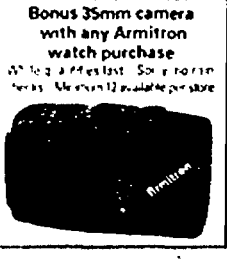

Bonus 35mm camera with any Armitron watch purchase  
At participating stores. Some restrictions apply. See store for details.

Sale 29.99

Sale 29.99

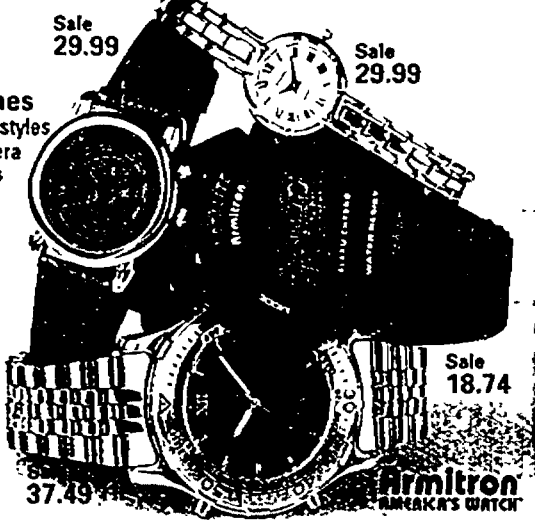

37.49

Sale 18.74

**2399** **TIMEX EXPEDITION**

**Timex® watches**  
 Reg. 27.99 Save \$4  
**10% Off\* All Other Timex® Watches**  
\*Reduction is off reg. prices



**1599**

**Timex® mini clocks**  
 • Quartz movement, assorted styles  
 Reg. 19.99. Save \$4  
**20% Off Reg. Prices On All Other Alarm Clocks**  
Sold in Jewelry Dept.

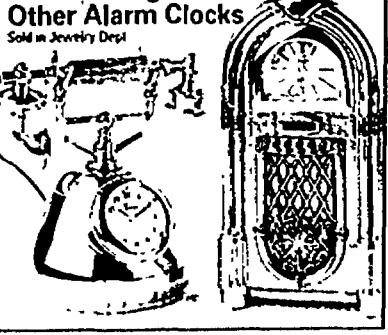

**1499**

**Jewelry boxes**  
 • Etched glass designs  
 • Assorted wood finishes  
 Our Everyday Low Price

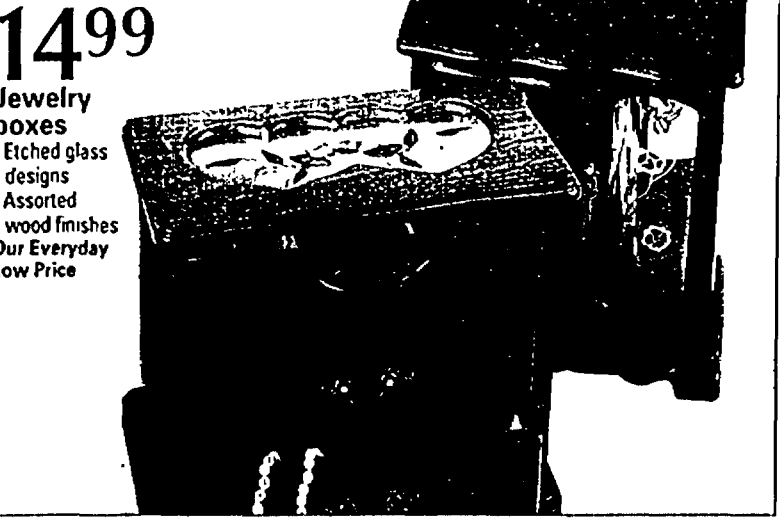

**25% off**

**Entire stock of hair accessories**  
 Reduction is Off Reg. Prices  
Sold in Fashion Accessories Dept.



FINE JEWELRY POLICY: Regular prices reflect the highest sales prices which may or may not have been made. Sale does not apply to price reduced clearance or already low priced merchandise. Jewelry shown may be subject to availability. Jewelry shown may be sold on a limited basis. Jewelry shown may be sold on a limited basis. Jewelry shown may be sold on a limited basis. Jewelry shown may be sold on a limited basis. Jewelry shown may be sold on a limited basis.

**SALE PRICES ON THIS PAGE EFFECTIVE NOVEMBER 28, 29, 30**

# 3-Day Sale! Thursday,

**14<sup>99</sup>**  
 Entire stock of loungewear  
 • 1- and 2-piece styles  
 Reg. 19.99. Save \$5

**30% off**  
 Our entire stock of ladies' robes  
 Reduction Is Off Reg. Prices

Sale 19.59

**12<sup>99</sup>**  
 All ladies' flannel sleepwear  
 • 100% cotton  
 • Fashion prints  
 Reg 13.99-19.99  
 Save \$1-\$7

**6<sup>99</sup>**  
**Bed Buddy**  
 • Microwavable heat pack  
 • Provides moist heat for aches and pains  
 Reg. 9.99. Save \$3

**9<sup>99</sup>**  
 Men's or ladies' lined leather or spandex gloves  
 Reg: 11.99-14.99. Save \$2-\$5  
**25% Off\* All Other Leather, Suede And Spandex Gloves**  
\*Reductions off reg prices

**4<sup>99</sup>**  
**Ladies' Chic® hoodwraps**  
 • Fashion colors  
 Reg 7.99 Save \$3

**6<sup>49</sup>**  
**Ladies' Fruit Of The Loom bonus 7-pack panties**  
 • 100% cotton, briefs or high-cuts  
 Reg 7.99 Save 1.50

**20% off**  
**Timex youth and character watches**  
 • Various faces including 101 Dalmatians  
 Reg. 14.99-24.99, Sale 11.99-19.99  
**25% Off\* Character Pens**  
\*Reductions off reg prices

Sale 13.59

**15<sup>99</sup>**  
 Entire stock of kids' character twin sheet sets  
 Reg. 19.99 Save \$4  
 Twin Comforters, Sale 30.99  
**20% Off\* Coordinating Bath Sets And Accessories**  
\*Reductions off reg prices

8.99  
 101 Dalmatians Pillow, Reg 11.99

**25% off**  
**101 Dalmatians kids' costume jewelry**  
 • Assorted earrings, necklace, rings  
 Reduction Is Off Reg. Prices

**9<sup>99</sup>**  
**Disney's 101 Dalmatians plush Christmas stocking**  
 • Featuring your favorite puppy characters  
 Dipstick, Two-tone, Wizzer and Lucky  
 Reg. 12.99. Save \$3

**25% off**  
**Disney's 101 Dalmatians accessories**  
 • Backpacks, handbags or coin purses  
 • 20-pc. hair accessories kit  
 Reduction Is Off Reg. Prices  
Sold in Fashion Accessories Dept.

**One girls' sweater at regular price, get the 2nd sweater (of equal or lesser value) at 50% Off\* the regular price**  
 Assorted patterns  
 • Sizes 4-16

SALE PRICES ON THIS PAGE EFFECTIVE NOVEMBER 28, 29, 30.

# Friday & Saturday



Buy one boys' sweater at regular price, get the 2nd sweater (of equal or lesser value) at 50% Off\* the regular price 30% Off\*\* All Boys' Dress Or Casual Pants, Suspenders, Shirts, Belts Or Ties  
\*Applies to in-store merchandise only  
\*\*Reduction is off reg. prices



Buy 1 pair kids' jeans, get the 2nd

**1/2 Price\***

\*Buy one pair of kids' jeans at the regular price and get the second pair (of equal or lesser value) at 50% off the regular price.



Wrangler • Brittanias • Rustler  
Route 66® • Chic

**2/\$8**  
Sale! Boys' or girls' turtlenecks  
• Boys' sizes 4-7; girls' sizes 4-6X  
Boys' 8-18; Girls' 7-16,  
Sale 2/\$9  
Infants' Or Toddlers',  
Sale 2/\$7



**25% off**  
Boys' team sportswear  
Reduction is Off Reg. Prices  
Team names and styles will vary by locale



**25% off**  
Girls' dresses or skirt sets  
• Sizes 4-16  
Reg 16.99-19.99  
Sale 12.74-14.99



**25% off** Kids 101 Dalmatian Fashion  
• Boys' sizes 4-14; girls' sizes 4-16  
• Girls' 8-18; Boys' 7-16  
• Reduction is Off Reg. Prices



Photographed at the 101 Dalmatians attraction at Disneyworld

**2.99**  
Infants' or toddlers' unisex fleece separates  
• Solid colors  
• Cotton/polyester  
Reg 3.99 Save \$1  
Unisex Print Separates  
Reg 4.99, Sale 3.99

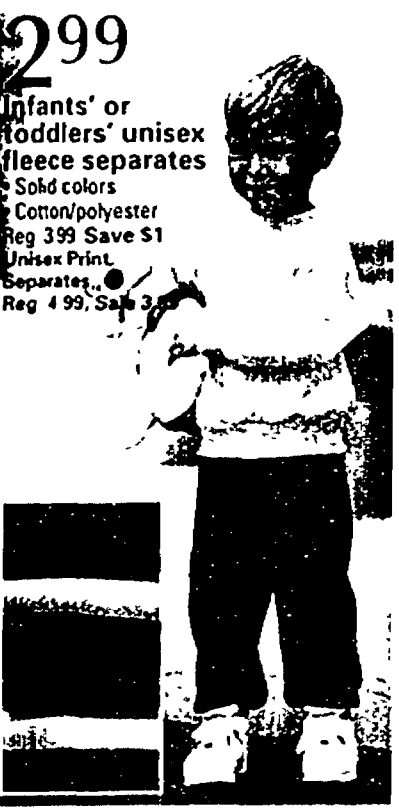

**3.99**  
Infants', toddlers' blanket sleepers  
Reg 4.99 Save \$1  
25% Off Reg. Prices On Other Blanket Sleepers



Buy one boys' flannel shirt at regular price, get the 2nd flannel shirt (of equal or lesser value) at 50% Off the regular price



**25% off**  
Children's sleepwear  
• Boys' or girls' 4-14  
• Infants', toddlers' sizes  
Reg. 5.99-7.99  
Sale 4.49-13.49



**4.99** Sale Price  
~~5.10~~ Mail-In Rebate  
Price After Mail-In Rebate  
**3.99**  
Boys' or girls' fleece separates  
• Cotton/polyester  
• Boys' 4-18, girls' 4-16  
Reg. 5.99 Save \$2  
With Rebate  
Rebate limited to mfr.'s stipulations



SALE PRICES ON THIS PAGE EFFECTIVE NOVEMBER 28, 29, 30

# 3 Day Sale! Thursday,

## Family Shoe Sale!

Buy one pair, get the 2nd pair 1/2 price

• Northwest Territory® • E.Z. Strider®  
• Cobbie Cuddlers® • Many more  
Buy one pair of shoes at the regular price, and get the second pair (of equal or lesser value) at 50% off the regular price. Buy two, four, six or more. There are no limits!  
Applies to in-stock merchandise only. Styles shown are representative of assortment and may vary by store. Does not apply to advertised merchandise.



Animal slippers for the family

999

Family animal slippers  
• Great for gift giving  
• Men's, women's and children's sizes  
Reg. 12.99-14.99. Save \$3-\$5



Friday only!  
6 a.m. to 11 a.m.

Enter to win  
a 3' Dalmatian  
plush stocking!  
A \$100 value!



Stop by your local Kmart store on November 29, between 6 a.m. and 11 a.m., and you could win a plush Dalmatian stocking - filled with Disney and Dalmatian gifts! No purchase necessary! Just register for your chance to win! The drawing will be at 3 p.m. - and the lucky winner will be announced in-store! Stockings courtesy of Alpo®

ALPO

CELEBRATES

KC BE  
DALMATIANS

Buy one pair or package of hosiery, get the 2nd

1/2 off

Buy one pair or pkg. of hosiery at the regular price, and get the second pair or pkg. (of equal or lesser value) at 50% off the regular price  
Applies to in-stock merchandise only. Styles shown are representative of assortment and may vary by store.



APPLY FOR  
A K MART  
CREDIT CARD  
TODAY!



When you use your Kmart Credit Card, you could earn  
**KMART REWARDS**  
UP TO 6%

6

See store for details.

SALE PRICES ON THIS PAGE EFFECTIVE NOVEMBER 28, 29, 30

# Friday & Saturday



**1699** Blaster and shield all in one

**Sale! Your choice of Manta Ray™ or Crossbow™**

- Max-Force™ Manta Ray™ blaster
- Crossbow™ with toy darts and arrows

60475 (8) 60476 (8) 60477 (8) 60478 (8) 60479 (8) 60480 (8) 60481 (8) 60482 (8) 60483 (8) 60484 (8) 60485 (8) 60486 (8) 60487 (8) 60488 (8) 60489 (8) 60490 (8) 60491 (8) 60492 (8) 60493 (8) 60494 (8) 60495 (8) 60496 (8) 60497 (8) 60498 (8) 60499 (8) 60500 (8)

**1099** Sale! Choice of family games

- Upwords
- Karate Fighters
- The Game Of Life
- Clue™
- Guess Who?
- Sorry™
- Electronic Magic
- Twister
- Star Wars™ Customizable Card Game™
- PayDay™

**799**

**Sale! Butterfly Light Up push toy**

- Sparkling lights show through dome
- Butterfly has fabric wings, moveable arms
- Includes long life lithium battery

**1899**

**Sale! Basic Building set or Thunder Raceway**

- Basic building set with carrying case
- Raceway set builds 3 different games

**1919** Fisher Price

**Sale! Fisher Price Activity Walker**

- Helps steady their first steps
- Fold flat for storage, additional play mode

**1279** Tonka

**Sale! Mighty Tonka dump truck**

- Tilt back dump box carries big loads
- Steel construction, made in USA

**1099** Sale! Choice of family games

- Upwords
- Karate Fighters
- The Game Of Life
- Clue™
- Guess Who?
- Sorry™
- Electronic Magic
- Twister
- Star Wars™ Customizable Card Game™
- PayDay™

**1779** Playmates

**Sale! Newborn Baby So Beautiful™ dolls**

- Feed her, change her diaper
- Includes locket and baby book

**3599**

**Sale! Cannonball express train set**

- 137 pieces, 65x38 E-Z track™ system
- 2 manual switches, power pack

**1499** Sale! Choice of children's games

- Cold Turkey, Koo Koo Nauts, Toss Across™
- Channel Surfing, Lucky Ducks
- 13 Dead End Drive, Space Shooter
- Check-up Charlie

**1439**

**Sale! Doodle Bear™**

- Sign, tattoo and doodle on Doodle Bear
- Wash and begin again
- 4 styles to choose from

**879**

**Sale! Your choice of construction toy sets**

- 4-pc construction set with hard hat
- 2-pc giant dump truck set with loader

**899** Fisher Price

**Sale! Zoom Tracer Desk™**

- Back-lit drawing board, paper, crayons
- 5 tracing templates with over 90 images
- Adjusts to enlarge or reduce images

**1899**

**Sale! Yactory™ mega-morphing vac factory**

- Create your own army of warriors
- Includes 6 action figures

**1359**

**Sale! Yak electronic toys**

- Yak Write SFX records, warps, writes and adds cool sound effects to your yak
- Yak Bakwards warps forward and back

**1199**

**Sale! Lite-Brite®**

- Includes 16 color-coded picture sheets
- 400 plastic pegs in 8 colors
- Create colorful, glowing pictures

**1599**

**Sale! Wild & Wacky Painter™**

- "No mess" art center
- Fingerprint, decorate, create patterns
- Paint, paper and tools included

SALE PRICES ON THIS PAGE EFFECTIVE NOVEMBER 28, 29, 30

# 3 Day Sale! Thursday,



**25% off**  
**Christmas slices or mats**  
 • Machine washable  
 • Nonskid backing  
 Reduction Is Off Reg. Prices



**4.99**  
**Christmas pillows**  
 Reg 7.99. Save \$3  
**25% Off\* All Other Decorative Pillows**  
\*Reduction is off reg. prices

## Christmas kitchen coordinates 30% off



**30% off**  
**Christmas kitchen accessories**  
 • Vinyl or fabric place mats, runners, chair pads, towels, pot holders, oven mitts, trivets, rugs  
 Reduction Is Off Reg. Prices



**7.49**  
**3-pc. Christmas bath sets**  
 • Bath towel, hand towel, washcloth  
 • Varied holiday patterns  
 Reg 9.99 Save 2.50



**99¢**  
**Decorative Christmas fingertip towels**  
 • Popular Christmas patterns  
 Our Everyday Low Price



**25% off**  
**All flannel sheet sets**  
 • Twin, full, queen, king; 100% cotton  
 • Solids, prints, yarn dyes, kids' character sets  
 Reduction Is Off Reg. Prices

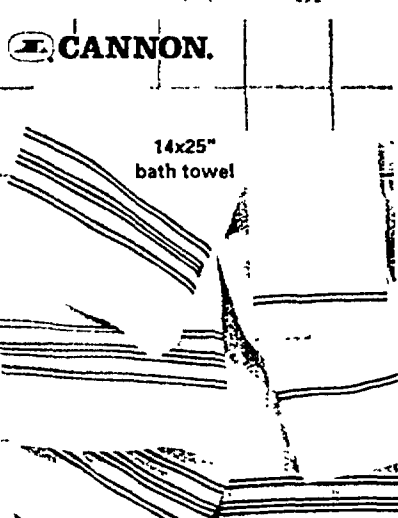

**CANNON.**  
 14x25" bath towel  
 Woven of 100% cotton  
**4.99**  
**Cannon 3-pc. towel set**  
 • Bath towel, hand towel, washcloth  
 • White with contrasting piping  
 Our Everyday Low Price



**5.99**  
**Balloon toppers**  
 • Wide new assortment  
 Reg 8.99-9.99 Save \$3-\$4  
**25% Off\* All Other Soft Window Treatments**  
\*Reduction is off reg. prices



**27.99**  
**78x84" vinyl vertical blinds**  
 • Light-blocking blinds with wand control  
 Reg 39.99 Save \$12  
**30% Off\* All Other Vertical Blinds**  
\*Reduction is off reg. prices



**3.99**  
**23x42" mini blinds**  
 • Room darkening 1" slats tilt/wand  
 Reg 7.97 Save 3.98  
**30% Off\* All Other Mini Blinds**  
\*Reduction is off reg. prices



**18.99**  
**84" L pair Patricia draperies**  
 Reg 27.99. Save \$9  
**20% Off\* All Other Draperies And Panels**  
Four valance sold separately. \*Reduction is off reg. prices

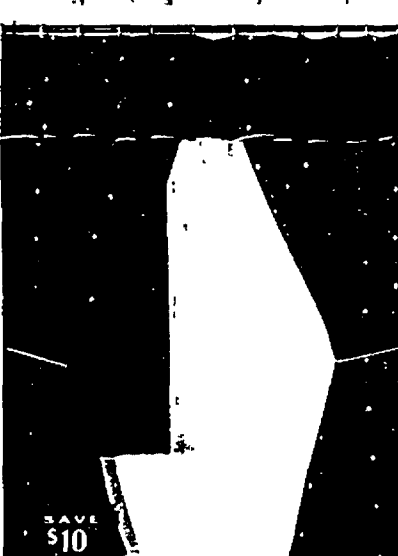

**19.99**  
**Color Classics™ double-swag shower curtain**  
 Reg. 29.99. Save \$10  
**20% Off\* All Other Fabric Shower Curtains**  
\*Reduction is off reg. prices



**4.99**  
**Any size Bed-In-A-Bag**  
 • Twin, full or queen size  
 • Sheet set, comforter, bedskirt, pillow sham(s)  
 Reg. 9.99-19.99. Save \$10-\$30



**2/\$9**  
**Grandpa jumbo bed pillow**  
 • Polyester/cotton striped tick  
 • Polyester fill  
 Reg 6.99 Ea. Save 2.49 Ea.



**7.49**  
**Choice of 21x34" bath rugs**  
 • "Cotton Classic" or "Rhapsody"  
 Reg. 9.99. Save 2.50  
**20% Off\* Reg. Prices On All Other Bath Rugs**  
\*Reduction is off reg. prices



**39.99**  
**58x91" room-size rug**  
 • Color fast, stain resistant  
 Reg. \$58. Save 18.01  
**20% Off\* All Other Room-size Rugs**  
\*Reduction is off reg. prices



**12.99**  
**23x96" traditional rug**  
 • Stain resistant; made in the U.S.A.  
 Reg. 25.99. Save \$13  
**50% Off\* Other Sizes Of Traditional Rugs**  
\*Reduction is off reg. prices

SALE PRICES EFFECTIVE NOVEMBER 28, 29, 30



# Friday & Saturday



6' high 485 tips

**2999**

**Smokey pine artificial Christmas tree**  
Reg. 39.99. Save \$10



**25% off**

Wide assortment of holiday gift items  
• Water balls, men's gifts, porcelain animals  
• Selected silver-plated gifts, musical dolls  
Reduction Is Off Reg. Prices

Holiday bear with 10th anniversary emblem



**999**

**10th anniversary 16" plush Holiday Bear**

• Plush bear with knit hat and scarf  
Reg. 12.99. Save \$3

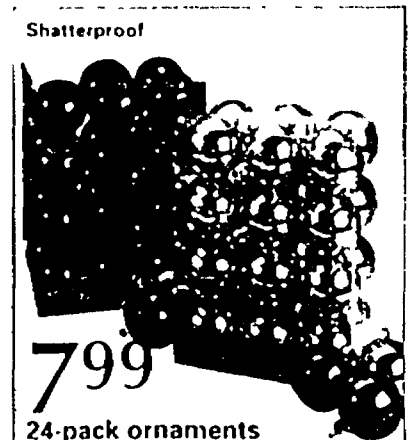

Shatterproof

**799**

**24-pack ornaments**  
• Shatterproof  
• Assorted holiday colors  
Reg. 9.99. Save \$2



**1999**

**Your choice! 24" figures**  
• Traditional Santa or Mrs. Claus, angel  
• Victorian doll, pajama-clad Mr. or Mrs. Claus  
Reg. 29.99. Save \$10



**299**

**Kodak 70-ct. Add-A-Light set**  
• Energy-saver design  
• Clear or multicolor  
Reg. 4.99. Save \$2

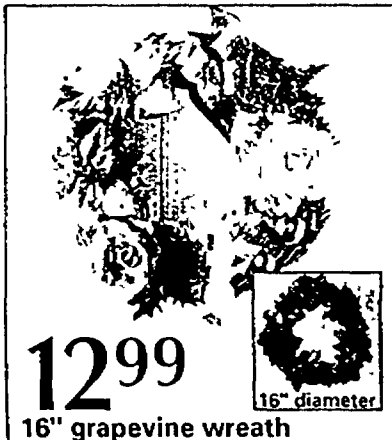

**1299**

**16" grapevine wreath**  
• Assorted styles  
• Boxed for easy storage  
Reg. 17.99. Save \$5



**999**

**Choice of holiday cookie jars**  
• Candy house, angel or snowman  
• Add a festive touch to any kitchen  
Our Everyday Low Price



**2/\$5**

**Christmas wrap**  
• 30" x 5' roll package, 125 sq. ft. total  
• 36" jumbo roll with 10 bows, 120 sq. ft.  
Reg. 4.99 Ea. Save 2.49 Ea.



**99¢**

**Christmas Glory cards**  
• 15 cards per set  
• Varied styles to choose from  
Reg. 1.50. Save 51¢

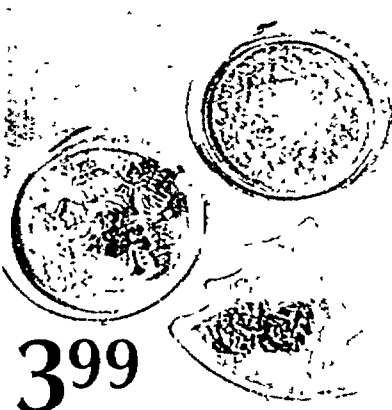

**399**

**Choice of holiday glass platters**  
• Tree, wreath or house design  
Reg. 4.99. Save \$1



**1499**

**23" or 29" bar stools**  
• 1" thick hardwood top  
• Natural- or white-finish legs  
Reg. 29.99. Save \$15



Fits up to 25" TVs

**4999**

**Entertainment center**  
• Black or oak laminate finish  
• 41 1/2" H x 48 1/2" W x 14 1/2" D  
Reg. 69.99. Save \$20  
Ready to assemble

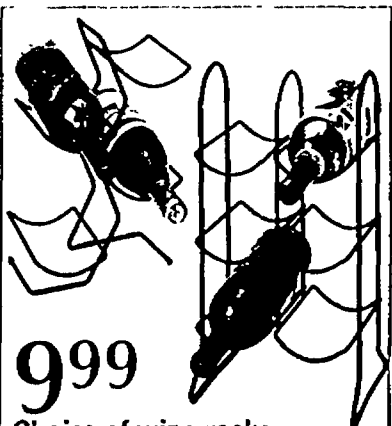

**999**

**Choice of wine racks**  
• 4-bottle wine tree  
• Town house wine rack  
Reg. 11.99-14.99. Save \$2-\$5



**699**

**5-pc. Baker's Secret gift set**  
• Nonstick coating, dishwasher safe  
• Great for all your basic baking needs  
Reg. 13.99. Save \$7



**499**

**24-pc. Prime Time glass beverage set**  
• Available in clear or blue  
Reg. 7.99. Save \$3

STYLED BY **Libbey**

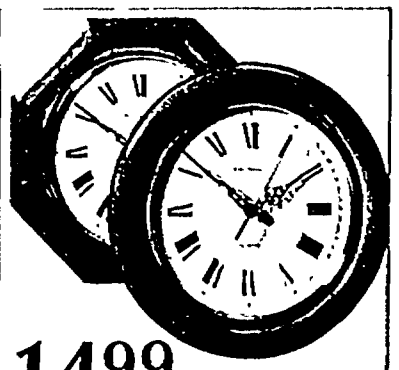

**1499**

**11" oak wall clock with gold-tone bezel**  
• Easy-to-read dial, sweep second hand  
Reg. 19.99. Save \$5

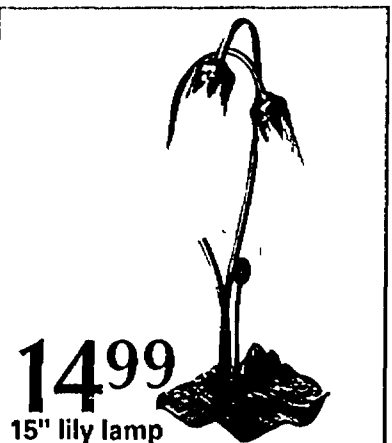

**1499**

**15" lily lamp**  
• Antique bronze lily pad base  
• White-frosted glass shade  
Reg. 19.99. Save \$5



**1499**

**Etched wall mirrors**  
• 16x20" or 16x24" size  
Reg. 19.99. Save \$5

**KMART REWARDS EARN UP TO APPLY TODAY!**

SALE PRICES ON THIS PAGE EFFECTIVE NOVEMBER 28, 29, 30

# 3-Day Sale! Thursday,

**CLEANING & MAINTENANCE - 170**

**HOOVER**

Stark-Beauty™ handle  
5-cc. 50% duty top  
Multiple

**SAVE \$30**

**7999**

Lowest price of the season on Hoover Runabout™ Supreme

- Triple filtration system, zippered soft bag
- Reg. 109.99. Save \$30

\*See Upright Tag Product Carton, or write to The Hoover Company for details

**15%-30% off small appliances**

**WEST BEND**

**Betty Crocker**

**Proctor-Silex**

**BLACK & DECKER**

**10999**

Your choice! Kitchen appliances

- Steam & dry iron, wide-slot toaster, can opener
- 3.5-qt. Crock Pot™, popcorn popper, 4-speed hand mixer
- 1.5-qt. coffee maker, 4-cup percolator, 32-oz. Hot Pot™
- Reg. 12.99-15.99! Save \$2-\$5

\*220V (Steam & Dry Iron) T2042 (Toaster) BC-1191 (Can Opener) 1.5-qt. Coffee Maker (120V) 32-oz. Hot Pot (120V) (Black & Decker) 11600 (Popcorn Popper) BC-1701 (Toaster) PC-3202 (Mixer)

Vertical spit with handle

**Sunbeam**

Bonus cookbook

**6999**

Sunbeam carousel rotisserie

- Bake-free cooking
- 1-hr. timer, auto-shutoff
- Reg. 79.99. Save \$10

20' cord

Interchangeable wand, wand and crevice tool

**Dirt Devil**

**2999**

Lowest price of the season on Dirt Devil Stick Vac™

- 4.0-amp motor, 2-speed switch
- 4-in.-1 cleaning system
- Reg. 44.99. Save \$15

Removable rack, door

Sounding bell

**BLACK & DECKER**

**6999**

Ultra Oven Toast-R-Oven™

- 1.5 cu. ft. capacity
- Toasts, browns, reheats and defrosts
- Reg. 79.99. Save \$9

**1199**

Your choice! Kitchen Basics™

- Regular or Belgian waffle maker
- Snack & sandwich maker
- Reg. 14.99. Save \$3

WB-958 (waffle maker) WB-957 (Belgian waffle maker) 1 (snack maker) SM-942 (sandwich maker)

Rotating turntable with flat-oven surface

**9999**

Price After Mir's \$20 Mail in Rebate

**Samsung 800-W microwave**

- 0.9 cu.-ft. capacity
- Reg. 129.99. Sale 119.99
- Save \$30 With Rebate

Electronic touch controls

Homemade bread with the push of a button

**Sunbeam**

**SAVE \$30**

**7999**

Sunbeam Hot-N-Fresh 1-lb. breadmaker

- Mixes, kneads, rises and bakes by itself
- Reg. 109.99. Save \$30

6-10

Bonus bread mix and 40 great recipes

**Betty Crocker**

**1099**

Choice of kitchen appliances

- Betty Crocker Pop Cooker/fryer/steamer
- Betty Crocker Brew 'N' Go or Betty Crocker coffeemaker
- Reg. 14.99. Save \$5-\$7

**Dazey**

**Silicone**

**799**

Electric skillet or can opener

- Reg. 9.99. Save \$2
- 3-qt. Slow Cooker, Reg. 17.99. Save \$2
- 1.5-qt. Slow Cooker, Reg. 17.99. Save \$2

Bakes a traditional loaf shape

**WEST BEND**

**4999**

West Bend 1 1/2-lb. breadmaker

- On Sale Thru Dec. 7
- Reg. 69.99. Save \$20
- 15% Off All Other Breadmakers

SALE PRICES ON THIS PAGE EFFECTIVE NOVEMBER 28, 29, 30

# Friday & Saturday



3-disc changer \$139 comparable value!

X-bass

**PHILCO**  
SLIPBUY

**9999**

Philco 3-CD mini stereo system

- AM/FM with cassette
- CD to cassette recording

Stereo wide

20" diagonal measure

TAKE ME HOME! JUST \$10 PER MONTH\* ON YOUR Kmart CREDIT CARD

**19999**

Your choice! GE 20" stereo color TV\* or RCA 4-head hi-fi VCR

Reg. 219.99. Save \$20

**RCA**

12.88 Columbia

12.88 Kid Rhino

12.88 550 Music

11.88 Warner Bros

11.88 Arista

**1288**

Sale! Choice of CDs

- "Space Jam" soundtrack
- Celine Dion's "Falling Into You"
- Barbara Streisand's "The Mirror Has Two Faces"
- Faith Hill Or Alan Jackson. Sale 11 88

Built-in closed caption

On-screen menu system

27" diagonal measure

"Toy Story" video, 16.95  
Our Everyday Low Price

SAVE \$50

**29999**

GE 27" stereo color TV with remote

- 39-button remote, auto-programming
- Commercial skip, 181-channel cable-ready tuning

Reg. 349.99. Save \$50

Fox Home Video

**1295**

Your choice of Disney videos

- Titles to please the entire family including "Mighty Aphrodite"

Reg. 14.99. Save 2 04

**1495**

5-tier multimedia tower

- Natural unfinished wood
- Holds 250 CDs, 90 videos or 145 cassettes

Reg. 19.99. Save \$5

Fox Home Video

**1295**

Sale! Musicals on video

- "The Sound of Music" with Julie Andrews
- "My Fair Lady" starring Rex Harrison and Audrey Hepburn

MCA/Universal

Warner Home Video

**1495**

Sale! Home videos

- "Twister"
- "The Nutty Professor"
- "Independence Day"

TAKE ME HOME! JUST \$10 PER MONTH\* ON YOUR Kmart CREDIT CARD

1-year (2-year) programmability

**16999**

Magnavox 4-head VCR

- 4-head system, clear freeze frame
- Special effects, slow motion

Reg. 189.99. Save \$20

TAKE ME HOME! JUST \$10 PER MONTH\* ON YOUR Kmart CREDIT CARD

On-screen menu

**11999**

Symphonic VCR

- Display in English or Spanish
- 1-yr./7-event programming

Reg. 139.99. Save \$20

Color coded

**1999** Sale Price

-1500 Mail in Rebate

499 Price After Mail in Rebate

50-pack computer diskettes

- Less than 10¢ a disk after rebate

Reg. 24.99. Save \$20 With Rebate

**699** Sale Price

-200 Mail in Rebate

499 Price After Mail in Rebate

Choice of blank tapes

- Audio-cassette, camcorder or VHS tapes

Reg. 8.99. Save \$4 With Rebate

5-speaker system

SAVE \$50

**16999**

5.1 surround-sound home theater

- Color-coded connections
- Performance amplifier, remote

Reg. 199.99. Save \$50

**ZENITH**

DOLBY SURROUND PRO-LOGIC

**599**

Universal remote

- 3-in-1 functions
- Use for TV, VCR, cable box

Reg. 8.99. Save \$3

GEU 430

**PHILCO**  
SLIPBUY

**4999**

Philco portable CD player

- CD track programmability, headphones
- Auto-power off, key hold switch

Reg. 5.99. Save \$1

**PHILCO**  
SLIPBUY

**4999**

Philco CD boom box

- CD repeat functions
- Full auto-stop tape deck

Reg. 5.99. Save \$1

SALE PRICES ON THIS PAGE EFFECTIVE NOVEMBER 28, 29, 30

# 3 Day Sale! Thursday,

89.99 Full-width pop out trimmer  
3 rotary heads  
Contour Reflex Action adjusts angles of shaving heads



**89.99** **36.89**  
Norelco  
Reflex Action rechargeable razor  
• Micro action closeness, 45 lifters and blades  
Reg 99.99 Save \$10  
Double Action Corded Razor, Sale 36.89

112 diamond-honed cutting edges  
Full-width pop-out trimmer



REMINGTON  
**29.99**  
Men's Remington dual-foil micro-screen corded razor  
• 2 ultra thin flexible foils  
Reg 34.99 Save \$5

AT&T  
Single cassette  
LED message indicator



**27.99**  
AT&T answering system  
• Remote access from touch-tone phone  
• Call intercept, changeable security code  
Reg 39.99 Save \$12

10 number memory  
Flash feature

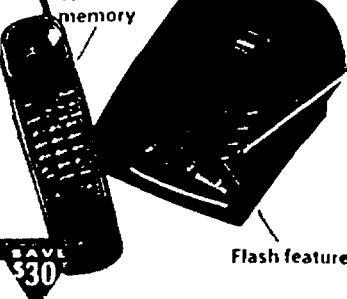

**99.99**  
uniden  
Uniden 900MHz cordless phone  
• Hearing aid compatible page/find system  
• Desktop use or wall mountable  
Reg 129.99 Save \$30

Razor-head release button  
Audible charge alarm  
Charging and recharging indicator lights



Norelco  
**49.99**  
Closeout! Norelco 885RX cord/cordless razor  
• 1-hr. or 3-min. quick charge, rechargeable  
Reg 74.99 Save \$25

Circulate massage to 5 areas of the body  
3 massage intensities



LED illuminated hand control

**69.99** **SAVE \$20**  
Homedics Back Pleaser™ Luxury Massage Seating System  
• 5 individual massage motors  
Reg 89.99 Save \$20

BRAUN  
Lockable head for precision shaving  
Pop-out long-hair trimmer  
Pivoting head



**46.99**  
Braun Flex Control rechargeable cordless razor  
• Platinum-coated twin-foil cartridge  
Reg 57.99. Save \$11

Powerful magnetic motor  
Pivoting neck brush



**17.99**  
Oster 15-pc. clipper set  
• Adjustable touch-lever blade  
• Easy to use; gives professional results  
Reg 23.99. Save \$6

GE 10-channel cordless phone  
10-number memory  
Compu-voice noise reduction



**39.99**  
GE 10-channel cordless phone  
• 10-number memory  
• Compu-voice noise reduction  
Reg 49.99. Save \$10

BELLSOUTH  
Bedroom phone or caller ID  
Phone with clock/snooze alarm  
Caller ID has 10-number memory



**19.99**  
Bedroom phone or caller ID  
• Phone with clock/snooze alarm  
• Caller ID has 10-number memory  
Reg 22.99-24.99. Save \$3-\$5

Kodak's APS Advantix cameras feature drop-in loading plus 3 picture formats on 1 roll of film!



**179.99** **139.99** **79.99** **59.99**  
Advantix APS 4100IX  
• Fully automatic 35mm zoom camera  
• Includes ISO 200 film\*, Lithium 3-V battery  
Reg 189.99. Save \$10  
\*15 exp.

**139.99**  
Advantix 3600IX  
• Focus-free 200 zoom auto focus lens  
• Triple format selection  
Reg 149.99. Save \$10  
Includes 15 exp. ISO 200 film and battery

**79.99**  
Sale! Advantix 3200AF compact camera  
• Triple format selection  
• Includes roll of ISO 200 film, 15 exp.

**59.99**  
Sale! Advantix APS  
• Auto film handling  
• Self timer  
• Drop in film loading

Kodak Cameo XRM 110 camera with 12-exp. film  
Motorized film operation, built-in flash  
Easy film loading, focus-free lens



**19.89**  
Kodak Cameo XRM 110 camera with 12-exp. film  
• Motorized film operation, built-in flash  
• Easy film loading, focus-free lens  
Reg 24.89. Save \$5

Kodak FunSaver 35 film camera  
ISO 400, 27 exposures total  
FunSaver With Flash, Sale 9.99



**5.99**  
Sale! Kodak FunSaver single-use camera  
• ISO 400, 27 exposures total  
FunSaver With Flash, Sale 9.99

Kodak 4-pack film  
135 ISO 100 film  
84 total exposures  
ISO 200, Sale 9.99; ISO 400, Sale 10.99



**7.99**  
Kodak 4-pack film  
• 135 ISO 100 film  
• 84 total exposures  
ISO 200, Sale 9.99; ISO 400, Sale 10.99

2 for 1 every day  
Overnight Service  
Kodak Premium Professional  
4" Prints  
4"x6" Prints - ready to share  
4"x6" Prints - in an album  
Prints from C-41 process only. 2 for 1 does not apply to our one-hour service or APS Advanced Photo System processing



SALE PRICES ON THIS PAGE EFFECTIVE NOVEMBER 28, 29, 30

\*Minimum monthly payment due with balance is up to 54% S.I. subject to credit approval. See store for details.

# Friday & Saturday



## BenchTop™ GUARANTEED FOREVER™

Deep-well sockets  
5/8" spark-plug socket  
2 screwdrivers  
3" extension bar  
3/4"-x" drive sockets  
Tire pressure gauge  
2 open end wrenches  
Chrome vanadium steel  
Push-button socket release  
Durable zipper storage case

**LOOK WHAT'S NEW AT KMART**

# 2999

On sale through December 24!  
**BenchTop™ 59-pc. mechanics' tool set**  
• 51 SAE and metric sockets, 2 quick-release ratchets  
• 2 wrenches, tire pressure gauge  
Reg. 3999 Save \$10

All products comply and addresses meet or exceed U.S. Federal Spec. 506 W 8431E

**STANLEY**  
**BLACK & DECKER**

**2699**

Choice of power tools  
• Black & Decker jigsaw or 3/8" drill  
• Driving Force 6-V cordless drill or Stanley staple/nail gun  
Reg. 27.49-29.99. Save 50¢-\$3

**DREMEL**  
**SKIL**

**3989**

Choice of power tools  
• 7.2-V cordless drill with 2 battery packs, charger  
• 7.2-V cordless rotary tool kit; 7" circular saw with 24-HP motor  
25 accessories

**BenchTop**

**799**

Choice of BenchTop™ tools  
• 6 pc. professional screwdriver set  
• 47 pc. ratchet driver set  
• 12 in. 1 pc. extension bar with bonus knife

**StackOn**

**7999**

Tool organizer by StackOn  
• 6 drawer lockable chest with hinged top  
• 2-drawer roll away cabinet  
Reg. 99.99 Save \$20

Including carrying case  
**TAKE ME HOME! JUST \$10 PER MONTH\* ON YOUR KMART CREDIT CARD**

Chain brake/hand guard  
16" sprocket tip bar  
Fully assembled

**McCulloch**  
**13999**

McCulloch 16" gas chain saw  
• Powerful 32CC engine, safety trigger  
• Electronic ignition, carrying case  
Reg. 149.99 Save \$10

**CARBON MONOXIDE DETECTOR**  
No batteries or replacement sensor required

AC plug-in  
Test/reset button

**2199**

Carbon monoxide detector  
• One year warranty, UL approved  
• Easy installation  
Reg. 24.99 Save \$3

Unique shape maximizes refrigerator space  
Filter features implosion protection

**1999**

Water filtration system  
• Fits in refrigerator door, eliminates 93% of lead  
• Bacteriostatic feature prevents bacteria growth  
Reg. 24.99. Save \$5

**BRITA**

Smokes up to 50 lbs. of food at one time  
**BRINKMANN™**  
Porcelain-coated water and charcoal pans

Front-access door for adding liquid, charcoal, wood chunks

**2499**

Sale! Smoke 'N' Grill  
• Easy-clean porcelain-coated pans  
• Rolled edges for greater strength  
Electric Smoker, Reg. 69.99, Sale 49.99  
813 5301 C (Smoke 'N' Grill) 816 7080 K (Smoke 'N' Grill)

**shop-vac**

Includes gulper nozzle and crevice tool

**2399**

Portable wet/dry Shop-Vac®  
• 1.0 peak horsepower motor  
• Lightweight, 1-gal. capacity  
Reg. 26.99 Save \$3

\*Minimum monthly payment due with balance of up to \$476.50. Subject to credit approval. See store for details.

SALE PRICES ON THIS PAGE EFFECTIVE NOVEMBER 28, 29, 30

# 3 Day Sale! Thursday,

**HUFFY®**

Water bottle  
Shimano index shifting  
Mud Maxx tires

**8999**

Adults' 26" "Backwater" bike  
• Men's or ladies' 18 speed bike  
Reg. 99.99 Save \$10  
Professionally Assembled 99.99

**HUFFY®**

**5999**

Kids' Looney Tunes™ 16" bike  
Reg. 79.99 Save \$20  
Professionally Assembled. 69.99  
"Star" Or "Rocket" Bike Helmet. Sale 9.99  
All 12"-24" Bikes On Sale

**NEW AT K MART**

**7999**

Weight bench  
with barbell set

Folds for easy storage

**6999** **AS BEEN ON TV**

Ab Sculptor  
• Targets all abdominals in one action  
• Includes video and nutritional guide  
Our Everyday Low Price

**WESLO**

**AS BEEN ON TV**

Adjustable push/pull handle bar  
New comfortable seat  
Motivational electronic monitor

TAKE ME HOME!  
\$10 PER MONTH ON YOUR K MART CREDIT CARD

**14999** **SAVE \$50**

Weslo Cardio Glide  
• Helps tone and condition muscles  
• Electronics feedback  
Reg. 199.99 Save \$50  
A.U. 64

**LOOK WHAT'S NEW AT K MART**

**TV**

Rowing machine

**1999**

Cycling gear

**WOLF CREEK**

**1199**

Spalding or Wolf Creek backpacks  
Reg. 14.99 Save \$3  
20% Off Reg. Prices On All In-stock Sporting Goods Backpacks

**10999**

Fishing duffel

**9999**

8-gun wood cabinet  
Reg. 124.99. Save \$25  
6 gun Wood Cabinet,  
Our Everyday Low Price 99.99  
Other Gun Cabinets  
\$10-\$25 Off Reg. Prices  
Guns and accessories in cabinets not included

**Air**

**2699**

Choice of BB guns  
• Daisy Red Ryder BB gun  
• Crosman 760  
Reg. 29.99 Save \$3  
15% Off Reg. Prices  
On All Other BB guns

**1799**

Tackle box or fishing vest  
• Stowaway Sport, 4-drawer or over/under tackle box  
• Poplin or mesh fishing vest  
Reg. 19.99-28.99. Save \$2-\$11  
1726 (Sport) 5257 (4 drawer) 5257 (over/under)  
Tackle not included

\*Minimum monthly payment due with balance of up to 34%. Subject to credit approval. See store for details.

SALE PRICES ON THIS PAGE EFFECTIVE NOVEMBER 28, 29, 30

# Friday & Saturday



**Drive In Style**  
3 in 1 Combo Gift Pack  
• Turtle Wax gift pack  
• 3 For The Road gift pack

**899**

Sale! Choice of automotive gift packs

- Turtle Wax gift pack
- 3 For The Road gift pack

**1999**

**Emerson**

Car audio system  
• AM/FM stereo/cassette  
• 2 speakers  
Reg 2499. Save \$5  
**20% Off\* All Other Car Stereos**  
1001 Emerson. \*Reduction on other prices.

4" 2-way speakers

LED indicators

LOOK WHAT'S NEW AT K MART

**1199**

Leather seat cushion with lumbar support  
Reg. 1999. Save \$8  
**25% Off\* All Other Seat Cushions**

**2399**

\*After Mfr's \$5 Mail in Rebate

The Club® steering-wheel lock  
Reg 3999. Save \$16 With Rebate  
2899 without mail in rebate  
The Truck Club®, 3399\*\*/Sale 3899

**1299**

Sale! Choice of auto accessory sets

- Turtle Wax accessory kit
- Armo® All gift set
- Interior gift set

LOOK WHAT'S NEW AT K MART

**999**

Blacks & Decker

LOOK WHAT'S NEW AT K MART

**1299**

Wet/dry car vac  
• Multifunctional  
• Heavy-duty  
• 20' cord

**999**

Prestone  
Antifreeze/Coolant

**9/8/1**

HEET  
Car Wash Soap

SPORTCRAFT

TAKE ME HOME! JUST \$10 PER MONTH\* ON YOUR K MART CREDIT CARD

LOOK WHAT'S NEW AT K MART

2, 11-player teams on steel rods

2 pushers, 4 pucks included

Butcher-block style

All wood construction

**1499**

Your choice of table games

- Air hockey game, 60x30"
- Soccer game, 48x24"

Reg 17999. Save \$30

\*Some base table required.

3 BEA PLAYER HAPPY

FREE-STYLE

Quick-Clip™ safety net release system

Portable base fills with water or sand

Full-color graphics won't fade or peel

TAKE ME HOME! JUST \$10 PER MONTH\* ON YOUR K MART CREDIT CARD

**12999**

Portable freestyle backboard

- Official backboard of the NBA
- Resin backboard is twice as strong as graphite

Reg 15999. Save \$30

**9999**

Perfect 13-piece golf package\*

- 3 titanium reinforced metal woods, 8 irons
- Lightweight golf bag, instructional video

Reg 12999. Save \$30

\*Men's or ladies' right hand only.

Includes Tom Weiskopf video

LOOK WHAT'S NEW AT K MART

**999**

Blacks & Decker

**999**

Youth basketball set

- Heavy-duty plastic pole and base
- 12" rim with net; backboard and basketball

Reg 1299. Save \$3

**3999**

Choice of golf travel bags

- Lockable hard case; airline approved
- Heavy-duty nylon case with padded straps

Reg 5699-6999. Save \$17-\$30

LOOK WHAT'S NEW AT K MART

**1499**

dart game

SPORTCRAFT

dartboard

**1499**

Trading card case or gear rack

- Case holds up to 2,000 cards; 12 organizing dividers
- Rack holds balls, skates, bats, hockey sticks

Reg. 1999. Save \$5

Gear and cards not included.

\*Minimum monthly payment due with balance of up to \$475. Subject to credit approval. See store for details.

SALE PRICES ON THIS PAGE EFFECTIVE NOVEMBER 28, 29, 30

**THREE-DAY SALE**  
**Thursday, Friday**  
**and Saturday**

**HURRY IN FOR**  
**Fantastic**  
**savings storewide!**

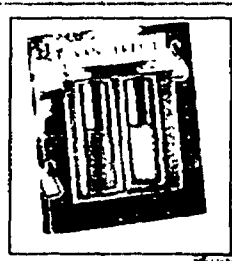

**Bath and fragrance gifts for under \$10**

- Vanilla Fields Navy, Lexa, or Madison
- Dream Christmas sets, Raw Vanilla
- Preferred Stock, Lady, or Men's Scented
- Glitter, Brut, Old Spice



**5.59**

**Filled-jar gift sets**  
 • Decorative glassware filled with gourmet foods  
 Reg. 6.99 Save 1.40



**7.99**

**Choice of gift sets**  
 • Set with commemorative bottle and tray  
 • Or set with straight razor set  
 Reg. 9.99 Save \$2



**3.99**

**Choice of decorative popcorn tins**  
 • 3.5 gal. units filled with popcorn  
 Reg. 5.99 Save \$2

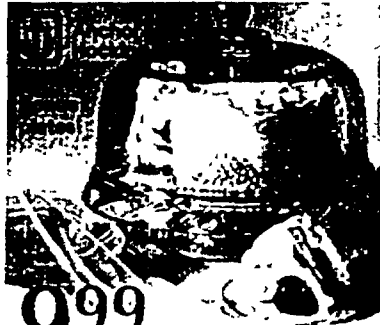

**9.99**

**Doubles cake dome with bonus server and plates**  
 • Beautiful serving piece for holiday parties  
 Reg. 14.99. Save \$5



**4/\$1**

**Choice of scented candles**  
 • Values 8 or 12 tapers  
 • 15 or 21 tapers  
 Reg. 5.25



**2/\$3**

**Sale! Act II microwave popcorn**  
 • 5.6 oz. net wt. per bag  
 • 2 for \$3



**2.50**

**Sale! 12 cans Coke products**  
 • 6 x Diet Coke, 6 x Sprite  
 • 12 oz. cans



**9.99**

**4-pc. storage jar set**  
 • Glass-lock top jars  
 • Embossed design  
 Reg. 11.99 Save \$2

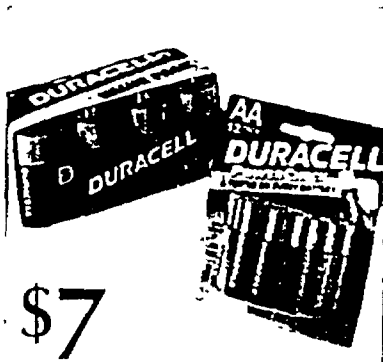

**\$7**

**Sale! Duracell batteries**  
 • AA or AAA 12 pack  
 • C or D 6 pack  
 • 9 volt 4 pack



**1.89**

**Sale! Chocolate-covered cherries**  
 • 12 kind of cherries  
 • 1 lb. net wt. per box



**4.79**

**Sale! Whitman's sampler**  
 • Assorted chocolates  
 • 1.75 lb. net wt. per box



**4.99**

**Amaryllis bulbs**  
 • Preplanted in plastic pots, 3 varieties  
 Reg. 5.99 Save \$1  
 Bulbs in Ceramic Pots Sale 7.99

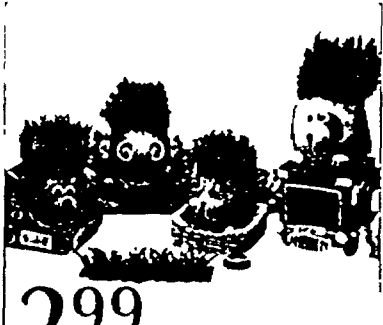

**2.99**

**Earth buddies**  
 • Just add water and watch them grow  
 • Assorted shapes  
 Reg. 3.99 Save \$1



**2.99**

**Sale! Chocolate-covered cashews**  
 • 11.5 oz. net wt.  
 • Perfect for holiday parties



**3/\$10**

**Sale! Choice of Downy or Bounce fabric softener**  
 • 40 fl. oz. Downy liquid  
 • 80 ct. Bounce sheets



**3.99**

**Plug-in timer**  
 • Automatically controls lamps, appliances  
 • Ideal for Christmas lighting  
 Reg. 4.99 Save \$1  
 1N111C60



**5.99**

**50-foot outdoor extension cord**  
 • Great for outdoor holiday lighting  
 Reg. 9.99. Save \$4  
 M1111160



**3.99**

**Sale! Miser indoor floodlight**  
 • 45- or 65 watt  
 Outdoor Halogen 45- Or 90 watt  
 Floodlight, Sale 5.99



**\$17**

**Sale! Pampers Baby Dry™ Mega unisex diapers**  
 • Sizes 1-5  
 • 68-120 per package

Special holiday shopping hours for your convenience: Open Thanksgiving Day 8 a.m.-8 p.m.\*; Friday 6 a.m.-11 p.m.; Saturday 8 a.m.-11 p.m.  
\*Except where prohibited by law



**Kmart advertised merchandise policy**  
 Merchandise advertised in this circular is either Sale Priced or at our Everyday Low Price. In some cases, we offer Special Buys which are available in limited quantities. Our item intention is to have every advertised item in stock on our shelves. If an advertised item is not available for purchase due to any unforeseen reason, Kmart will issue a Rain Check on request for the merchandise (one item or reasonable family quantity) to be purchased at the advertised price whenever available or will sell you a comparable quality item at a comparable price. Merchandise only available in United States stores. Regular prices may vary in some stores due to local competition. Layaway not available in all stores. © 1996 Kmart Corporation. Visit Kmart on the internet! World Wide Web <http://www.kmart.com>

Call 1-800-866-0086 for the location of your nearest Kmart Store Pharmacy, Auto Center or Little Caesars® Pizza Station® in Kmart Pharmacies are located in over 1,500 Kmart stores nationwide. We accept most insurance plans. Ask us about yours.

All merchandise advertised in this circular is available at your local Kmart or Super Kmart.



**SPECIAL BUYS – HURRY IN WHILE QUANTITIES LAST!**

**BIG  
3 DAY  
SALE**

AMERICA'S LEADING JEWELER  
**Service**  
**MERCHANDISE**

**JEWELRY, GIFT AND HOME**

**LOW PRICE  
GUARANTEE!**  
WE'LL MATCH ANY COMPETITOR'S  
ADVERTISED PRICE!  
See back cover for details.

**OHIO ART MICHAEL  
JORDAN**  
NBA  
SIR JAMES  
JAMES

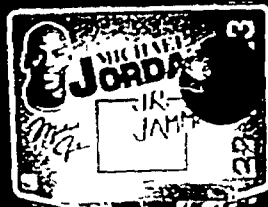

Ohio Art Michael  
Jordan Basketball Set.  
676THA

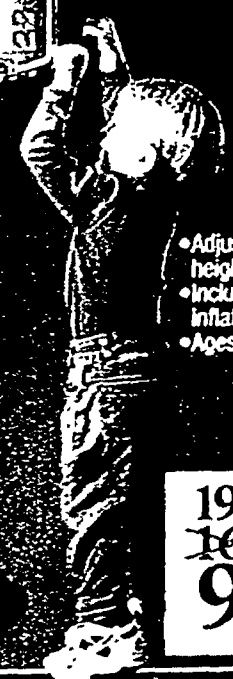

- Adjustable height
- Includes inflatable ball
- Ages 3 and up

1995 Ref. #  
~~1699~~  
**996**  
Sale

**Diamond Solitaire  
Earrings**  
1/4 Ct. T.W.



275<sup>00</sup> Ref. #  
~~1999~~  
**870**  
Sale  
14K Gold  
(6072342)

**Save 50%**  
1 Ct. T.W.  
Rose-Cut  
Diamond  
Bracelet



1400<sup>00</sup> Ref. #  
~~2999~~  
**4990**  
Sale  
(471135)

- Quantities limited
- Goldplated sterling silver

**1996  
Angel  
Bell**



1500<sup>00</sup> Ref. #  
~~1299~~  
**297**  
Sale  
(1996NTS)

•While supplies last

**HUFFY  
BICYCLES  
U.S.A.**

Your Choice

59<sup>95</sup> Ref. #  
~~5499~~  
**3999**  
Sale



Huffy 16" Bike.  
Includes training wheels. SP  
31836HM Girls' Jazz-Best  
31820HM Boys' Turbo 926

**PRICE  
BUSTER**

12<sup>94</sup>  
Reg



- She tips

Toy Biz Baby  
Headstand  
Burgundy.  
Ages 3 and up.  
33201JBL \$14.95!

**Your Choice**

39<sup>95</sup> Ref. #  
~~1999~~  
**1499**  
Sale



Assorted Santas. Porcelain figurines. 20TH  
Century. 10 styles to choose from.

**Compact Disc  
KIT**



Special Value  
74<sup>95</sup> Ref. #  
~~6999~~  
**4999**  
Sale

Koss Portable Car CD Player Model  
CDP200RF. 16-track programming. Dynamic bass  
boost. Uses 2 AA batteries, not incl. SP: D200KER

**AT&T** PRODUCT CENTER Service

AT&T Cordless Phone  
Model 4335. SP  
4335ABL Dove Gray  
4335BUABL Burgundy  
4335BKABL Black  
4335GABL Hunter Green

Special Purchase  
While Supplies Last

69<sup>95</sup> Ref. #  
~~5999~~  
**3999**  
Sale



**AS SEEN  
ON TV**



Portable AB Roller.  
Features adjustable arm and  
head bars. Disassembles for  
easy storage. 660506MEM

59<sup>95</sup> Ref. #  
~~4999~~  
**3999**  
Sale

**FUNAI**



Funai 1-Lb. Breadmaker.  
(Automatically makes a loaf of  
bread at the touch of a button.)  
SP: 2220FNA

89<sup>95</sup> Ref. #  
~~7999~~  
**4999**  
Sale

**0%  
INTEREST, NO  
PAYMENTS 'TIL MARCH '97**

On All Storewide Purchases Of \$100 Or More! See back cover for details.

Service  
MERCHANDISE  
000 0000 000000 0

**SPECIAL HOLIDAY HOURS**  
MON.-SAT. 9 AM to 10 PM  
SUN. 10 AM to 7 PM  
December 16-23  
Open 8 AM to Midnight

Sale Ends  
December 1

Diamond Solitaires In 14K Gold  
Just For You

3000<sup>00</sup> Ref. +  
2499<sup>00</sup> Reg.  
**1999<sup>00</sup>** Sale  
1 Ct.  
(41710062.J)

1995<sup>00</sup> Ref. +  
1799<sup>00</sup> Reg.  
**1499<sup>00</sup>** Sale  
5/8 Ct.  
(41206362.J)

1295<sup>00</sup> Ref. +  
999<sup>00</sup> Reg.  
**799<sup>00</sup>** Sale  
3/8 Ct.  
(41203862.J)

All Diamond Solitaire Pendants And Earrings  
**On Sale!**

1295<sup>00</sup> Ref. +  
999<sup>00</sup> Reg.  
**899<sup>00</sup>** Sale  
1/2 Ct.  
14K Gold  
(46705042.J)

2595<sup>00</sup> Ref. +  
1999<sup>00</sup> Reg.  
**1499<sup>00</sup>** Sale  
1 Ct. T.W.  
14K Gold  
(46110062.J)

795<sup>00</sup> Ref. +  
599<sup>00</sup> Reg.  
**499<sup>00</sup>** Sale  
1/2 Ct. T.W.  
14K Gold  
(46105062.J)

560<sup>00</sup> Ref. +  
399<sup>00</sup> Reg.  
**199<sup>00</sup>** Sale  
1/2 Ct. T.W.  
14K Gold  
(46705062.J)

495<sup>00</sup> Ref. +  
399<sup>00</sup> Reg.  
**299<sup>00</sup>** Sale  
1/3 Ct. T.W.  
14K Gold  
(46103362.J)

0% Interest And No Payment

850<sup>00</sup> Ref. +  
599<sup>00</sup> Reg.  
**399<sup>00</sup>** Sale  
1 Ct. T.W.  
(442213.J)

210<sup>00</sup> Ref. +  
149<sup>00</sup> Reg.  
**99<sup>00</sup>** Sale  
1/4 Ct. T.W.  
(442212.J)

425<sup>00</sup> Ref. +  
299<sup>00</sup> Reg.  
**199<sup>00</sup>** Sale  
1/2 Ct. T.W.  
(442211.J)

1795<sup>00</sup> Ref. +  
1299<sup>00</sup> Reg.  
**999<sup>00</sup>** Sale  
1 Ct. T.W.  
14K Gold  
(442196.J)

850<sup>00</sup> Ref. +  
599<sup>00</sup> Reg.  
**399<sup>00</sup>** Sale  
1/2 Ct. T.W.  
14K Gold  
(442204.J)

3995<sup>00</sup> Ref. +  
2999<sup>00</sup> Reg.  
**2499<sup>00</sup>** Sale  
2 Ct. T.W.  
14K Set  
(425001.J)

1125<sup>00</sup> Ref. +  
799<sup>00</sup> Reg.  
**599<sup>00</sup>** Sale  
1/2 Ct. T.W.  
14K Band  
(425016.J)

1795<sup>00</sup> Ref. +  
1299<sup>00</sup> Reg.  
**999<sup>00</sup>** Sale  
1 Ct. T.W.  
14K Gold  
(427140.J)

2095<sup>00</sup> Ref. +  
1499<sup>00</sup> Reg.  
**999<sup>00</sup>** Sale  
1/2 Ct. T.W.  
14K Set  
(424125.J)

2795<sup>00</sup> Ref. +  
1999<sup>00</sup> Reg.  
**1499<sup>00</sup>** Sale  
3/4 Ct. T.W.  
14K Gold  
(421121.J)

2250<sup>00</sup> Ref. +  
1599<sup>00</sup> Reg.  
**1299<sup>00</sup>** Sale  
1 Ct. T.W.  
14K Gold  
(427130.J)

695<sup>00</sup> Ref. +  
499<sup>00</sup> Reg.  
**399<sup>00</sup>** Sale  
1/3 Ct. T.W.  
14K Gold  
(427061.J)

1395<sup>00</sup> Ref. +  
999<sup>00</sup> Reg.  
**499<sup>00</sup>** Sale  
1 Ct. T.W.  
14K Gold  
(427154.J)

850<sup>00</sup> Ref. +  
599<sup>00</sup> Reg.  
**499<sup>00</sup>** Sale  
1/2 Ct. T.W.  
14K Gold  
(427002.J)  
Yellow  
(428003.J)  
White

350<sup>00</sup> Ref. +  
249<sup>00</sup> Reg.  
**179<sup>00</sup>** Sale  
1/2 Ct. T.W.  
14K Gold  
(427145.J)

Save 50%

•Band sold separately

Exclusive!

Great Savings On  
Diamond Fashion Rings

**0%** Service  
INTEREST,  
NO PAYMENTS  
TIL MARCH '97  
ON STOREWIDE PURCHASES  
OF \$100 OR MORE

Beautiful Baguette  
Diamonds  
And Color

Your Choice  
99<sup>90</sup>

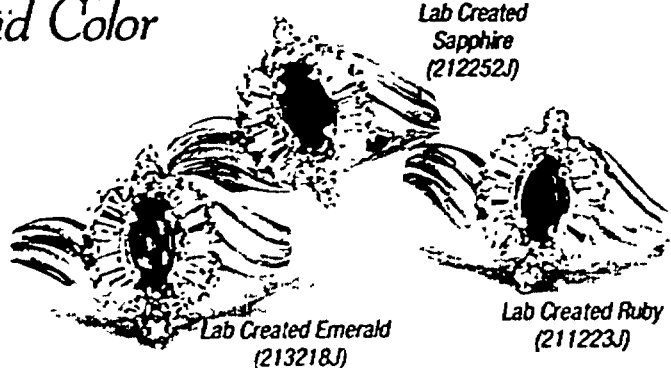

Lab Created Sapphire  
(212252.J)

Lab Created Emerald  
(213218.J)

Lab Created Ruby  
(211223.J)

Your Choice  
119<sup>90</sup>

A Diamond Gift  
She Will Love

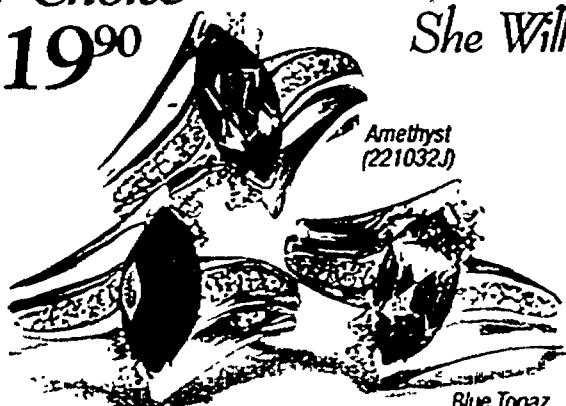

Amethyst  
(221032.J)

Garnet  
(223087.J)

Blue Topaz  
(222180.J)

All "S" Link Diamond Tennis Bracelets  
On Sale

2 Ct. T.W.

479<sup>90</sup>  
Sale  
Promo Quality  
Reg. \$699.90  
\$975.00†  
(471129.J)

799<sup>90</sup>  
Sale  
Value Quality  
14K Gold  
Reg. \$999.90  
\$1395.00†  
(471081.J)

1797<sup>00</sup>  
Sale  
Premiere Quality  
14K Gold  
Reg. \$2297.00  
\$3200.00†  
(471054.J)\*

3 Ct. T.W.

679<sup>90</sup>  
Sale  
Promo Quality  
Reg. \$999.90  
\$1395.00†  
(471130.J)

1199<sup>90</sup>  
Sale  
Value Quality  
14K Gold  
Reg. \$1499.90  
\$2095.00†  
(471089.J)

2499<sup>00</sup>  
Sale  
Premiere Quality  
14K Gold  
Reg. \$2999.00  
\$3995.00†  
(471038.J)\*

5 Ct. T.W.

1999<sup>00</sup>  
Sale  
Value Quality  
14K Gold  
Reg. \$2999.00  
\$3995.00†  
(471091.J)

4999<sup>00</sup>  
Sale  
Premiere Quality  
14K Gold  
Reg. \$5499.00  
\$7600.00†  
(471070.J)\*

Until March On Purchases Of \$100 Or More

3/4 Ct. T.G.W. Gemstone Rings  
With White Sapphires

Your Choice  
299<sup>90</sup>



Lab Created Blue Sapphire  
(214037.J)

Lab Created Ruby  
(214033.J)

Lab Created Alexandrite Rings  
With Diamond Accents



695<sup>00</sup> Ref. †  
499<sup>00</sup> Reg.  
399<sup>90</sup> Sale  
1/7 Ct. T.W.  
(228018.J)

560<sup>00</sup> Ref. †  
399<sup>00</sup> Reg.  
299<sup>90</sup> Sale  
1/10 Ct. T.W.  
(228011.J)

Purple Color Changes To Reflect  
Shades Of Red And Green

650<sup>00</sup> Ref. †  
499<sup>00</sup> Reg.  
399<sup>90</sup> Sale  
1/2 Ct. T.W.  
14K Gold  
(473134.J)

350<sup>00</sup> Ref. †  
249<sup>00</sup> Reg.  
199<sup>90</sup> Sale  
1/4 Ct. T.W.  
14K Gold  
(473135.J)



1125<sup>00</sup> Ref. †  
799<sup>00</sup> Reg.  
599<sup>00</sup> Sale  
14K Gold  
(472195.J)

1/3 Ct.

The Diamond Solitaire Necklace

1 Ct. T.W.  
1650<sup>00</sup> Ref. †  
1199<sup>00</sup> Reg.  
899<sup>90</sup> Sale  
14K Gold  
(472132.J)

1/2 Ct. T.W.  
695<sup>00</sup> Ref. †  
499<sup>00</sup> Reg.  
399<sup>90</sup> Sale  
14K Gold  
(472128.J)

\*Due to the uniqueness of this item, it is available but may not be on display in all stores. T.G.W. = total gem weight. Please call or visit your local Service Merchandise store for availability. T.W. = total diamond weight. Diamond weights are not exact. See chart on page 11 of our Fall Catalog for size ranges. Jewelry may be shown larger than actual size to show beauty of detail. † See reference price details on back cover.

# All Gold Rope And Link Chains On Sale From 49<sup>90</sup> To 899<sup>00</sup>

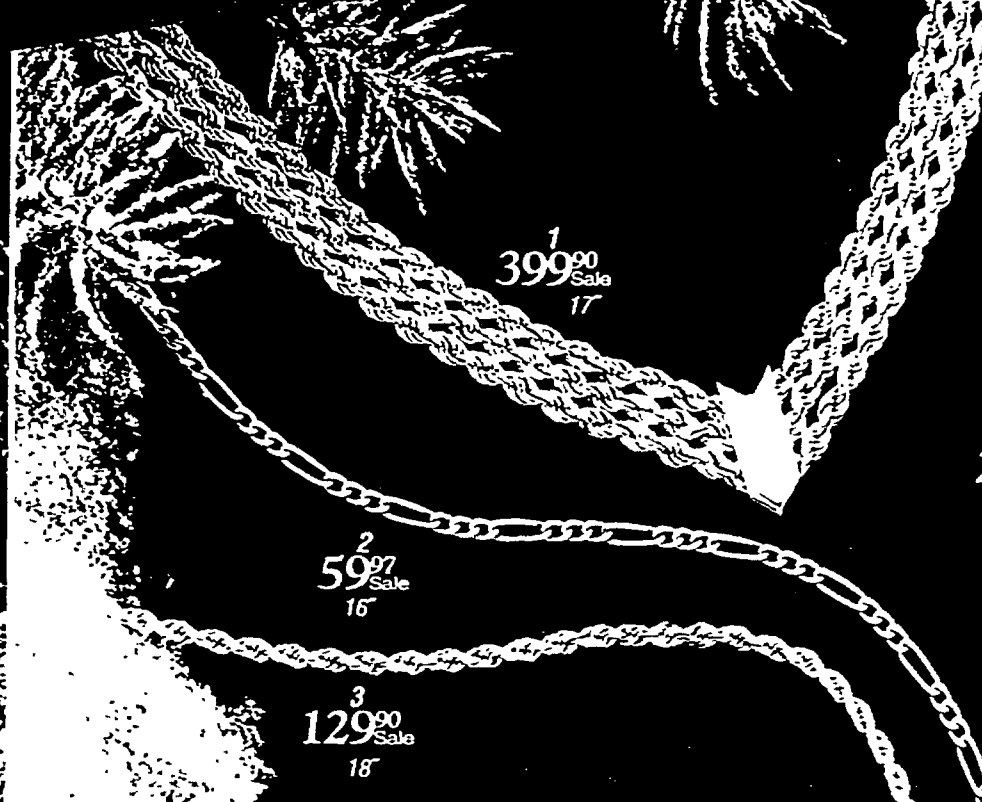

1  
399<sup>90</sup>  
Sale  
17"

2  
59<sup>97</sup>  
Sale  
15"

3  
129<sup>90</sup>  
Sale  
18"

4  
229<sup>90</sup>  
Sale  
20"

5  
199<sup>90</sup>  
Sale  
18"

6  
229<sup>90</sup>  
Sale  
18"

1. V-Shaped Triple Rope Chain. 14K gold.  
9444017J 17" \$625.00† Reg. \$449.90 ..... Sale \$399.90  
2. Figaro Chain. 14K gold.  
9526016J 16" \$97.50† Reg. \$69.97 ..... Sale \$59.97  
Also On Sale: 18", 9" anklet  
3. Solid Rope Chain. 10K gold.  
8451818J 18" \$195.00† Reg. \$139.90 ..... Sale \$129.90  
Also On Sale: 20", 24"

4. Concave Mariner Chain. 10K gold.  
8510220J 20" \$350.00† Reg. \$249.90 ..... Sale \$229.90  
5. Diamond-Cut Curb Chain. 10K gold.  
8510118J 18" \$320.00† Reg. \$229.90 ..... Sale \$199.90  
Also On Sale: 20", 8"  
6. Value Quality Solid Rope Chain. 14K gold.  
9462318J 18" \$350.00† Reg. \$249.90 ..... Sale \$229.90  
Also On Sale: 20", 24"

125<sup>00</sup> Ref.†  
80<sup>97</sup> Reg.  
69<sup>90</sup> Sale  
(331001J)

525<sup>00</sup> Ref.†  
37<sup>97</sup> Reg.  
299<sup>90</sup> Sale  
14K Gold  
(331056J)

560<sup>00</sup> Ref.†  
39<sup>97</sup> Reg.  
299<sup>90</sup> Sale  
14K Gold  
(332009J)

115<sup>00</sup> Ref.†  
76<sup>97</sup> Reg.  
59<sup>97</sup> Sale  
14K Gold  
(322493J)  
Petite  
Regular  
Sale \$119.90  
Reg. \$129.90  
\$180.00†  
(322447J)

140<sup>00</sup> Ref.†  
115<sup>97</sup> Reg.  
99<sup>90</sup> Sale  
14K Gold  
(322621J)

165<sup>00</sup> Ref.†  
115<sup>97</sup> Reg.  
99<sup>90</sup> Sale  
14K Gold  
(322346J)

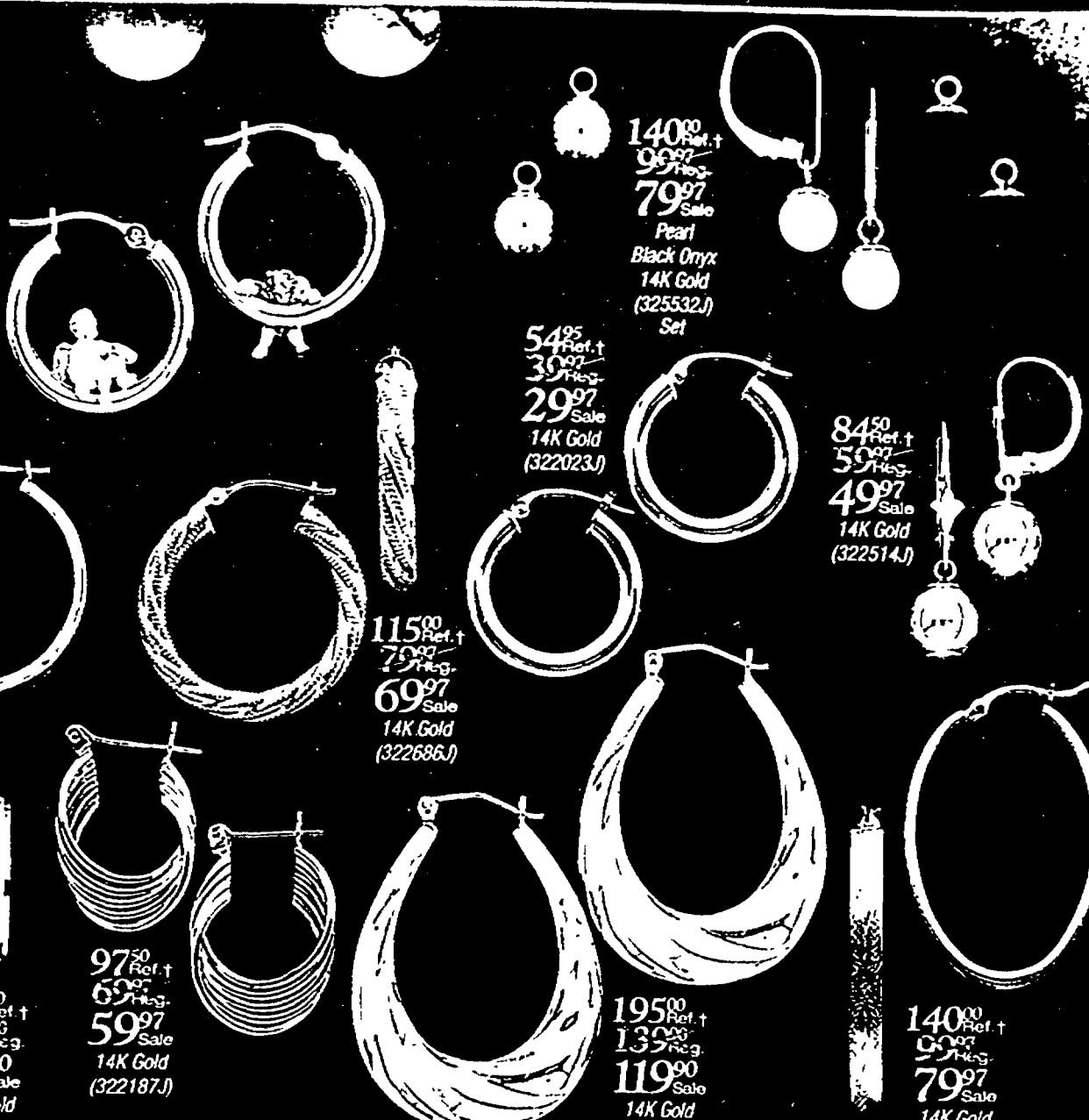

140<sup>00</sup> Ref.†  
99<sup>97</sup> Reg.  
79<sup>97</sup> Sale  
Pearl  
Black Onyx  
14K Gold  
(325532J)  
Set

54<sup>95</sup> Ref.†  
39<sup>97</sup> Reg.  
29<sup>97</sup> Sale  
14K Gold  
(322023J)

84<sup>50</sup> Ref.†  
59<sup>97</sup> Reg.  
49<sup>97</sup> Sale  
14K Gold  
(322514J)

115<sup>00</sup> Ref.†  
76<sup>97</sup> Reg.  
69<sup>97</sup> Sale  
14K Gold  
(322686J)

97<sup>50</sup> Ref.†  
69<sup>97</sup> Reg.  
59<sup>97</sup> Sale  
14K Gold  
(322187J)

195<sup>00</sup> Ref.†  
139<sup>97</sup> Reg.  
119<sup>90</sup> Sale  
14K Gold  
(322325J)

140<sup>00</sup> Ref.†  
99<sup>97</sup> Reg.  
79<sup>97</sup> Sale  
14K Gold  
(322616J)

349<sup>90</sup> Woven Curb Link Bracelet. 14K gold.  
332015J 8" \$560.00† Reg. \$399.90 ..... Sale \$349.90

Service  
MERCHANDISING

**BIG  
3 DAY  
SALE**

**25-33% OFF** Manufacturer's  
Suggested  
Retail Prices On  
**ENTIRE STOCK OF**

**BIG  
3 DAY  
SALE**

**CITIZEN - SEIKO - PULSAR**

**140<sup>00</sup> Ref. #**  
~~189<sup>00</sup> Reg.~~  
**89<sup>99</sup> Sale**  
(AC11225EWM)

**215<sup>00</sup> Ref. #**  
~~189<sup>00</sup> Reg.~~  
**159<sup>97</sup> Sale**  
(EH845259WWM)

**175<sup>00</sup> Ref. #**  
~~149<sup>00</sup> Reg.~~  
**129<sup>97</sup> Sale**  
(EK262251EWM)

**160<sup>00</sup> Ref. #**  
~~129<sup>97</sup> Reg.~~  
**109<sup>97</sup> Sale**  
Mother-Of-Pearl  
(EK296253DWM)

**200<sup>00</sup> Ref. #**  
~~149<sup>00</sup> Reg.~~  
**129<sup>97</sup> Sale**  
(SXE372WEK)

**450<sup>00</sup> Ref. #**  
~~339<sup>00</sup> Reg.~~  
**299<sup>97</sup> Sale**  
(SKH060WEK)

**399<sup>95</sup> Ref. #**  
~~299<sup>90</sup> Reg.~~  
**269<sup>97</sup> Sale**  
(SXE380WEK)\*

**425<sup>00</sup> Ref. #**  
~~329<sup>99</sup> Reg.~~  
**299<sup>97</sup> Sale**  
Diamond  
(SZZA56WEK)

**135<sup>00</sup> Ref. #**  
~~169<sup>00</sup> Reg.~~  
**99<sup>99</sup> Sale**  
Masonic Medallion  
(PRS444RLP)

**125<sup>00</sup> Ref. #**  
~~99<sup>99</sup> Reg.~~  
**89<sup>99</sup> Sale**  
(PPG566RLP)

**110<sup>00</sup> Ref. #**  
~~79<sup>97</sup> Reg.~~  
**69<sup>99</sup> Sale**  
(PT0004RLP)

**110<sup>00</sup> Ref. #**  
~~89<sup>97</sup> Reg.~~  
**79<sup>99</sup> Sale**  
(PXX006RLP)\*



**LORUS**  
*Entire Stock*  
**ON SALE**

Excluding Character Watches

\*Water and/or shock-resistant in accordance with U.S. Government standards. Chains may vary slightly in length. Jewelry may be shown larger than actual size to show beauty of detail. †/‡ See reference price details on back cover.

**54<sup>95</sup> Ref. #**  
~~44<sup>99</sup> Reg.~~  
**39<sup>99</sup> Sale**  
(PU280LRC)  
Man's  
Lady's  
Reg. \$42.99  
\$54.95†  
(MER411RC)

**49<sup>95</sup> Ref. #**  
~~39<sup>99</sup> Reg.~~  
**34<sup>99</sup> Sale**  
(ZJ090LRC)

**42<sup>95</sup> Ref. #**  
~~32<sup>97</sup> Reg.~~  
**29<sup>99</sup> Sale**  
(ZK252LRC)

**64<sup>95</sup> Ref. #**  
~~49<sup>99</sup> Reg.~~  
**44<sup>99</sup> Sale**  
(PU294LRC)\*

**FREE 20-Pc. Set (486920HKK) And 5-Pc. Completer Set (486955HKK) With Purchase Of 20-Pc. Set (486920HKK).**

79<sup>95</sup> Ref.†  
**69<sup>99</sup>**



**Sango China "Delight" 20 pc. Stoneware Set.** Includes four each: dinner plate, salad plate, soup/cereal bowl, cup and saucer. 486920HKK

**20-pc. Dinnerware Set (486920HKK). A \$69.99 Value.**

**5-pc. Completer Set (486955HKK). A \$59.99 Value.**

**Service**  
MERCHANDISE

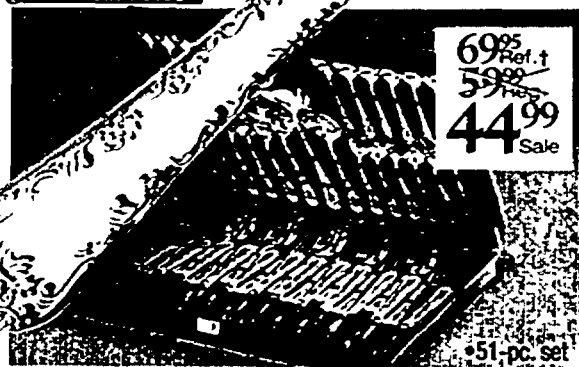

69<sup>95</sup> Ref.†  
~~59<sup>99</sup>~~  
**44<sup>99</sup>** Sale

**W.M. Rogers & Son 51-Pc. "Enchanted Rose" Silverplated Flatware Set With Chest.** Service for 12, plus 2 large serving spoons and 1 serving fork. Includes storage case 10017NTS

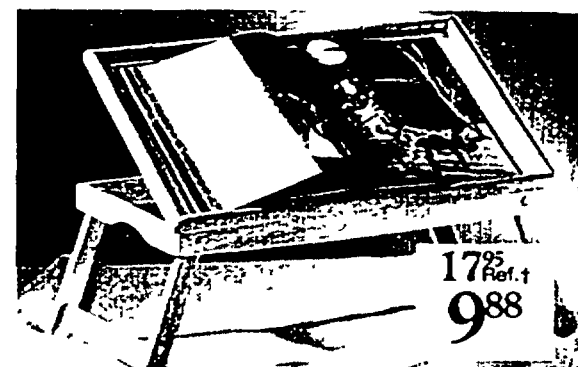

17<sup>95</sup> Ref.†  
**9<sup>88</sup>**

**Flip-Top Adjustable Bed Tray. 113099GHK**



34<sup>95</sup> Ref.†  
**24<sup>99</sup>**

**FREE Treasure Chest (23757GJD) With Purchase of Bookends (06351GJD). A \$14.99 Value!**

**Cristal d'Arques "Eventail" Bookends.** 24% lead crystal. 06351GJD



69<sup>95</sup> Ref.†  
~~59<sup>99</sup>~~  
**44<sup>99</sup>** Sale

**Wear-Ever**

**Wear-Ever "Premium" 9-Pc. Cookware Set.** Two 3-qt. covered saucepans, 5-qt. covered Dutch oven with meat rack, 8" and 10" chef-style frypans. Extra-heavy aluminum SilverStone non-stick interiors. Designed to heat evenly and resist warping. Made in USA. 46909WEA

# We're Your Holiday Source With



**Your Choice**

39<sup>95</sup> Ref.†  
~~29<sup>99</sup>~~  
**24<sup>99</sup>** Sale

**Preferred Stock® 4-Pc. Storage Set.** Includes air-tight locking seals. 4061TP White, 4062TP Almond, 4063TP Hunter Green



**Your Choice**

12<sup>95</sup> Ref.†  
**9<sup>99</sup>**

1. Durand "Academie" Vase. 59743GJD
2. Durand "Athena" Vase. 52804GJD
3. Preferred Stock® 8-Qt. Pasta Cooker. Stainless steel. Includes pot, pasta insert, steamer basket and lid. 4716K
4. 5-Pc. Pasta Set. 86ZZ \$19.95† Reg. \$14.99

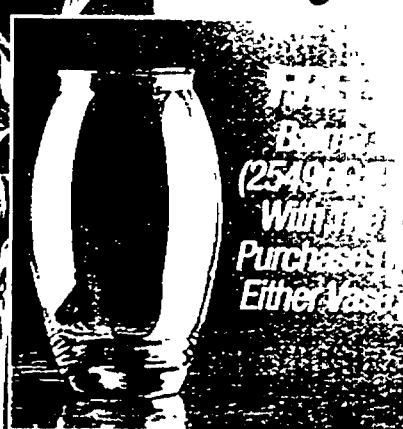

**Buy 1 Durand "Athena" Vase (52804GJD) With Purchase of Either Vase**

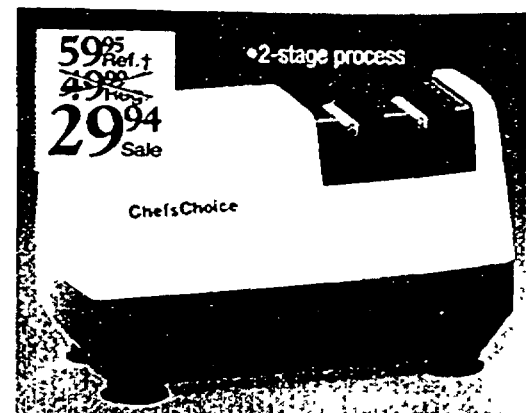

**Edgecraft 300 Chef's Choice Diamond Hone Sharpener. 300EDG**



3  
39<sup>95</sup> Ref.†  
~~34<sup>99</sup>~~  
**24<sup>99</sup>** Sale

**Special Value 9<sup>99</sup> Sale**



**Special Value** ~~9.99~~ Sale

**VIDAL SASSOON**

Vidal Sassoon Jetsetter 10 Hairsetter. 60-second heat-up. 10 rollers. Clip storage. Wrap-around cord storage. Zippered travel bag. Dual voltage. ~~Reg. \$16.95~~ **\$14.99**

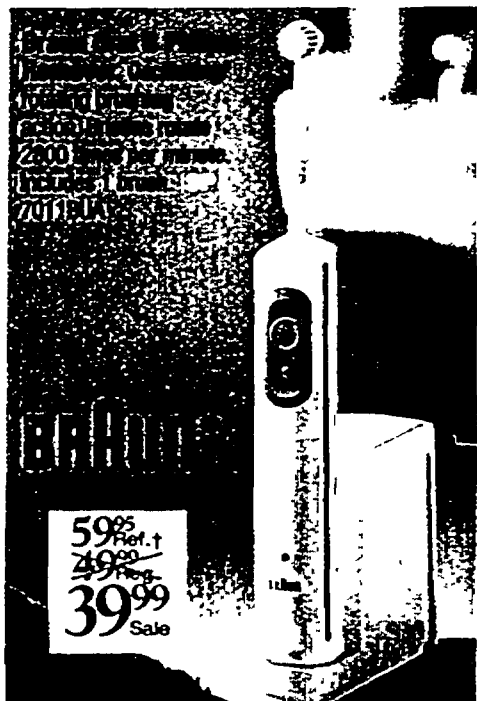

~~59.95~~ ~~49.95~~ **39.99** Sale

**5. Wahl Groomsman Cordless Trimmer.** Trims beard, mustache, sideburns and neckline. Trimming guide adjusts to 5 different lengths. Includes storage stand, mustache comb, cleaning brush and blade guard. Uses 3 AA batteries. ~~Reg. \$49.95~~ **\$39.99**

**6. Norelco Double Action Rechargeable Cord/Cordless Rotary Razor.** Pop-out trimmer, travel/storage pouch. ~~Reg. \$39.95~~ **\$34.99**

**7. Braun Flex Control Shaver With Bonus Travel Clock.** Pivoting head, pop-out trimmer, cord/cordless. 1-hour charge, 5-minute quick charge and dual voltage. Includes travel clock. ~~Reg. \$99.95~~ **\$79.99**



~~24.95~~ ~~19.95~~ **12.99** Sale

~~69.95~~ ~~49.95~~ **59.99** Sale

~~89.95~~ ~~79.95~~ **69.99** Sale

**BONUS!**  
10-week subscription to Sports Illustrated (a \$29.50 value) with the purchase of any Braun men's shaver. Offer expires 12/31/96.

\*Includes travel clock



~~34.95~~ ~~29.95~~ **27.99** Sale

**ROYAL**

Dirt Devil Hand Vac. Powerful 3.0-amp motor with deep-cleaning revolving brush. 20' cord. Lightweight, easy to use. ~~Reg. \$34.95~~ **\$27.99**

# The Perfect Gifts For Everyone On Your List



~~99.95~~ ~~89.95~~ **69.99** Sale

**JUICEMAN JR.**

Juiceman Jr. Juicer. Powerful 1/4-HP motor. Large feed tube and receptacle, auto pulp ejection, micro mesh screen. Easy to clean. ~~Reg. \$99.95~~ **\$69.99**

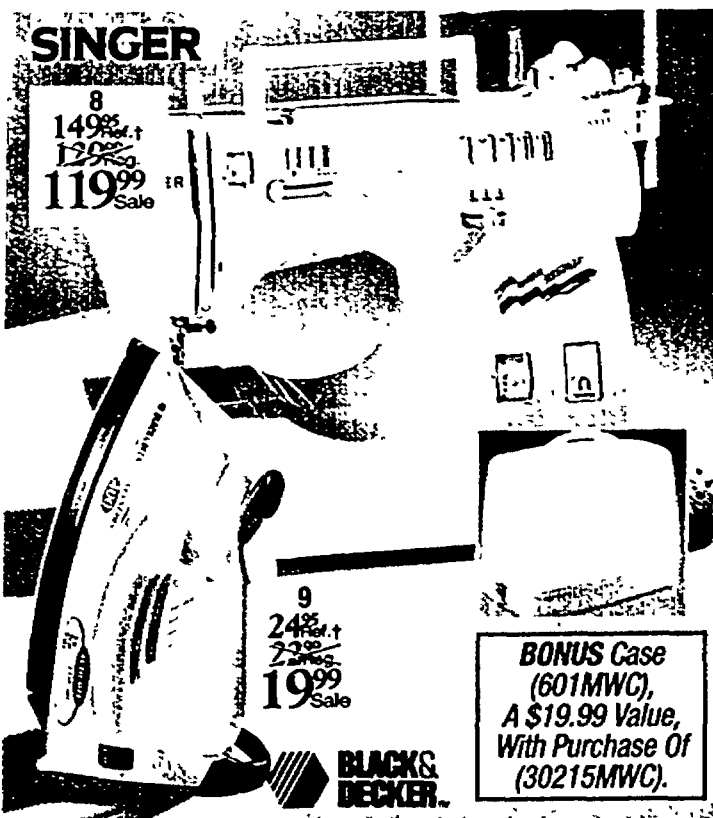

~~149.95~~ ~~129.95~~ **119.99** Sale

**8. Singer 15-Stitch Free-Arm Sewing Machine.** Touch and wind hand-wheel for easy bobbin winding and declutching. Buttonhole capability, built-in sewing light. Includes accessory kit and owner's manual. ~~Reg. \$149.95~~ **\$119.99**

~~24.95~~ ~~22.95~~ **19.99** Sale

**BONUS Case (601MWC), A \$19.99 Value, With Purchase Of (30215MWC).**

**9. Black & Decker Quick & Easy Auto Shutoff Iron.** Smart dial controls temperature, steam activator and auto cleaning. Sure steam system delivers right amount of steam at any setting. Auto clean steam valve. ~~Reg. \$24.95~~ **\$19.99**



~~29.99~~ ~~19.99~~ **-10.00** Mail-in Mr. Rebate Rebate exp. 11/30/96

**Save \$30 With Rebate**

~~26.95~~ ~~22.95~~ **19.99** Sale

**10. Braun Flavor Select 12-Cup Coffee Maker.** Flavor selector dial varies coffee flavor from mild to robust. Improved flavor seal carafe preserves taste, aroma and temperature. Pause 'n serve. ~~Reg. \$26.95~~ **\$19.99**

**11. Mr. Coffee 2-Qt. Iced Tea Pot.** Fresh brewed ice tea in less than 10 minutes. Made in USA. ~~Reg. \$22.95~~ **\$19.99**

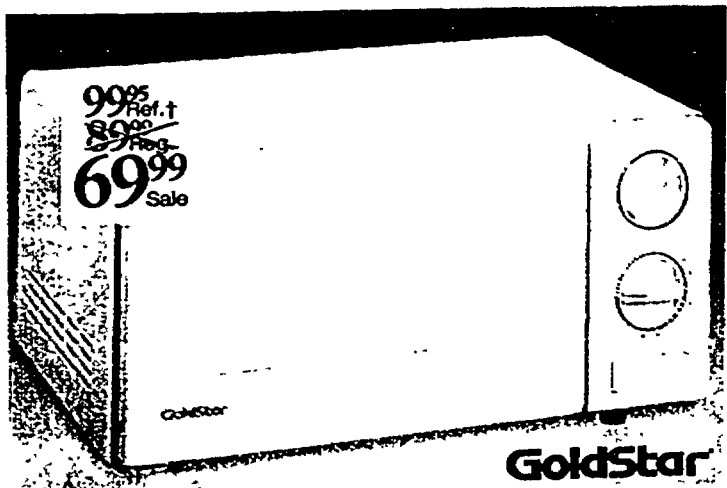

~~99.95~~ ~~89.95~~ **69.99** Sale

**GoldStar .6 Cu. Ft. Capacity Microwave Oven.** 600 watts, 2 power levels: defrost and cook. 30-minute timer, turntable. ~~Reg. \$99.95~~ **\$69.99**

\* Batteries not included.

ORDER BY PHONE 24 HOURS A DAY, 7 DAYS A WEEK FOR HOME DELIVERY! CALL TOLL FREE 1-800-251-1212.



**0%** *Service*  
**INTEREST,  
NO PAYMENTS  
'TIL MARCH '97**  
ON STOREWIDE PURCHASES  
OF \$100 OR MORE

Trees and ornaments available in most showrooms.

**Your  
Choice**

~~189.95 Ref. †  
169.99 Reg.  
149.99~~  
**149.99**  
Sale  
Item 3 Or 4



**0%** *Service*  
**INTEREST,  
NO PAYMENTS  
'TIL MARCH '97**  
ON STOREWIDE PURCHASES  
OF \$100 OR MORE



**Your  
Choice**

~~89.95 Ref. †  
79.99 Reg.  
49.99~~  
Sale

**\$30 Off!**

1. Gallery Tray Floor Lamp. Polished brass finish Ivory, mushroom pleat shade 150-watt max 16" diameter tray. 57"H. Made in USA. 3050JML
2. 6-Way Floor Lamp. Polished brass finish Ivory mushroom pleat shade 150-watt max 58"H Made in USA. 3079JML



**Alsy Earth-Look Table Lamp.** Beige knife pleat shade. 3-way switch uses up to 150-watt bulb 27H Made in USA. 23762KLY



**Capodimonte 3-Piece Rose Set.** Porcelain Includes Certificate of Authenticity 1219R

## Our Holiday Values Are

**Save  
\$20  
On Our  
Best  
Selling  
Armoires!**

3. Ashbury Armoire. Oak finish, 2 side doors with necklace hooks, flip-top lid with mirror, 5 small, 3 large drawers. 19Wx16½Dx42½H. 7127R
4. Powell Cherry Finish Jewelry Armoire. 18Wx15Dx40½H. Flip-top lid with mirror. Full-length side doors. 7 storage drawers. 899PWL

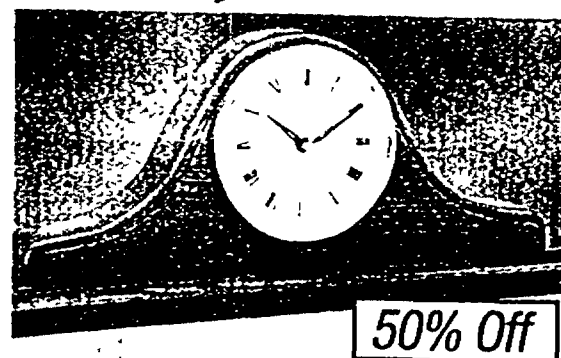

~~34.95 Ref. †  
29.99 Reg.  
14.99~~  
Sale

**Solid Oak  
Tambour Clock.**  
Uses 1 AA battery  
17Wx3Dx7½H. 6200DDK



**Strausbourg Manor® Wood  
Schoolhouse Clock.** Solid oak frame,  
hourly Westminster chime with night  
silencer. Uses 1 C battery.  
12½Wx4Dx19½H. \* EFTJ 1114C

**Strausbourg Manor® Wooden  
Regulator Clock.** Solid hardwood,  
hourly Westminster chime. Uses  
2 AA batteries. 12Wx3¼Dx22½H. \* EFTJ  
1121C



89.95 Ref. †  
~~69.99~~  
~~59.99~~  
59.99 Sale

Solid  
Oak!

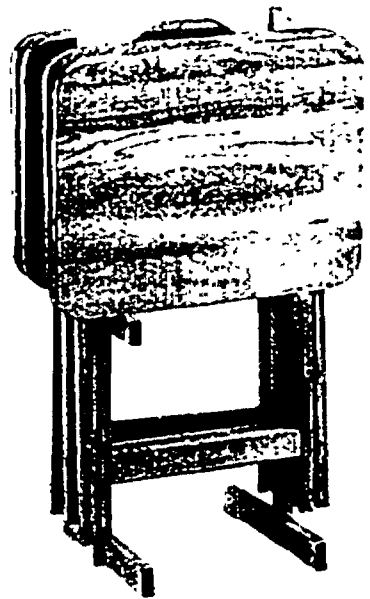

Easy Living® Tray Table Set.  
Includes trays and stand  
Solid oak. 6415F

\*Batteries not included. \*\*Assembly required. All lamps are U.L. listed. Lamps do not include light bulbs unless stated otherwise. †/‡ See reference price details on inside back cover.

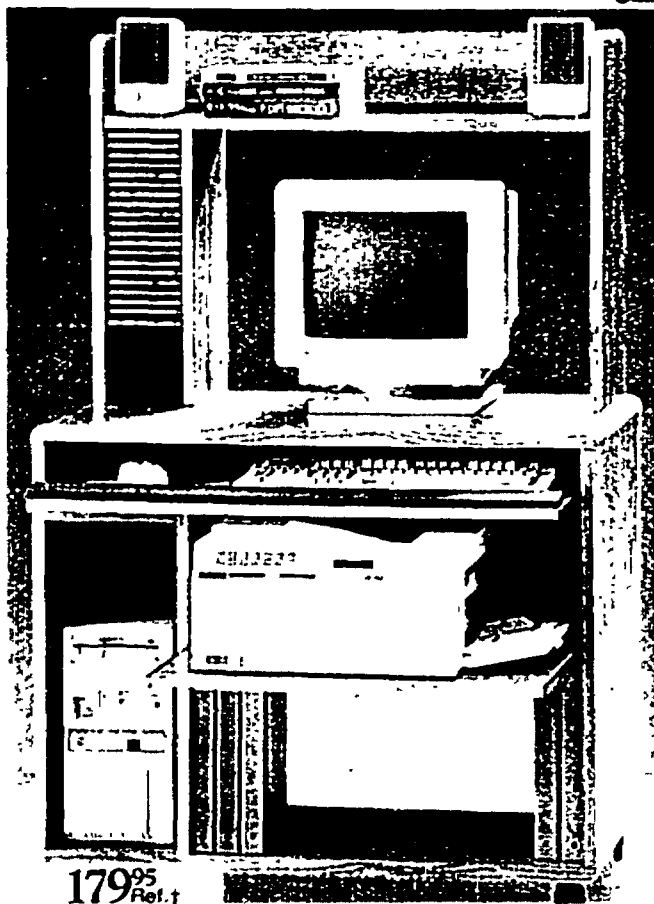

179.95 Ref. †  
~~149.99~~  
129.99 Sale

Bush Multi-Media Computer Cart.  
Accommodates complete CD ROM computer system. Hutch holds 20 CD's. Oak finish. Made in USA. 35" W x 19" D x 53" H. \*\* 7917BUH

89.95 Ref. †  
~~79.99~~  
69.99 Sale

Business  
Class



Business Class® Burgundy and Alder Office Chair.  
Contoured back and seat. Tilt back. Manual height adjustment. Scotchgard treated fabric. Fire retardant foam. Padded armrests. 5-star base. 21" W x 26" D x 36" H. \*\* 2223F



199.95 Ref. †  
~~179.99~~  
149.99 Sale

O'SULLIVAN

O'Sullivan Office Work center. Angled monitor platform. Pull-out keyboard shelf. CPU storage space. Large concealed storage. Bottom file drawer. Norwegian Alder finish. Made in USA. 5-yr. warranty. 53" W x 23" D x 47" H. \*\* 61933LLV

# Too Big For A Stocking... Too Good To Pass Up!



Destinations®

5-piece set

149.95 Ref. †  
~~129.99~~  
99.99 Sale

Destinations® 5-Pc. Luggage Set. Garment bag 23" W x 3D x 46" H. 28" pullman with wheels 28" W x 8" D x 20" H, 26" pullman with wheels 26" W x 8" D x 18" H, carry-on 20" W x 7" D x 14" H, tote 16" D x 6" W x 12" H. 22574L

5. Business Class® Vinyl Expandable Attache. Expands 4 to 5". Organizer. 18" W x 4-5" D x 13" H. 115111L. \$39.95† Reg. \$29.99

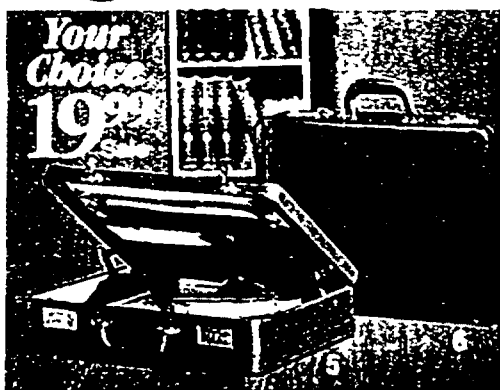

Your Choice  
19.99

6. Business Class® Vinyl Expandable Attache. Expands 4 to 5". Organizer. 18" W x 4-5" D x 13" H. 125111L. \$39.95† Reg.

229.95 Ref. †  
~~189.99~~  
169.99 Sale

26" EZ Cart. Exclusive 2-position retractable handle. Unique "4-wheel drive" system allows you to push

EZ  
CART.

•4 wheels

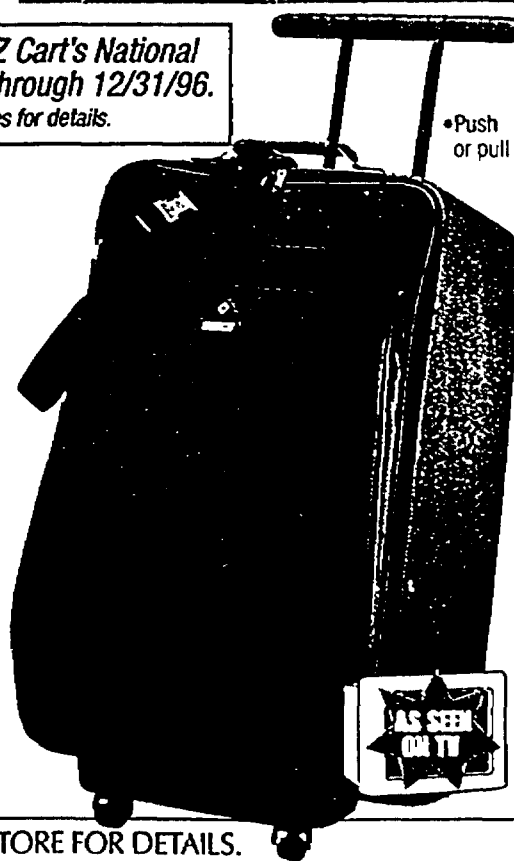

•Push or pull

AS SEEN ON TV

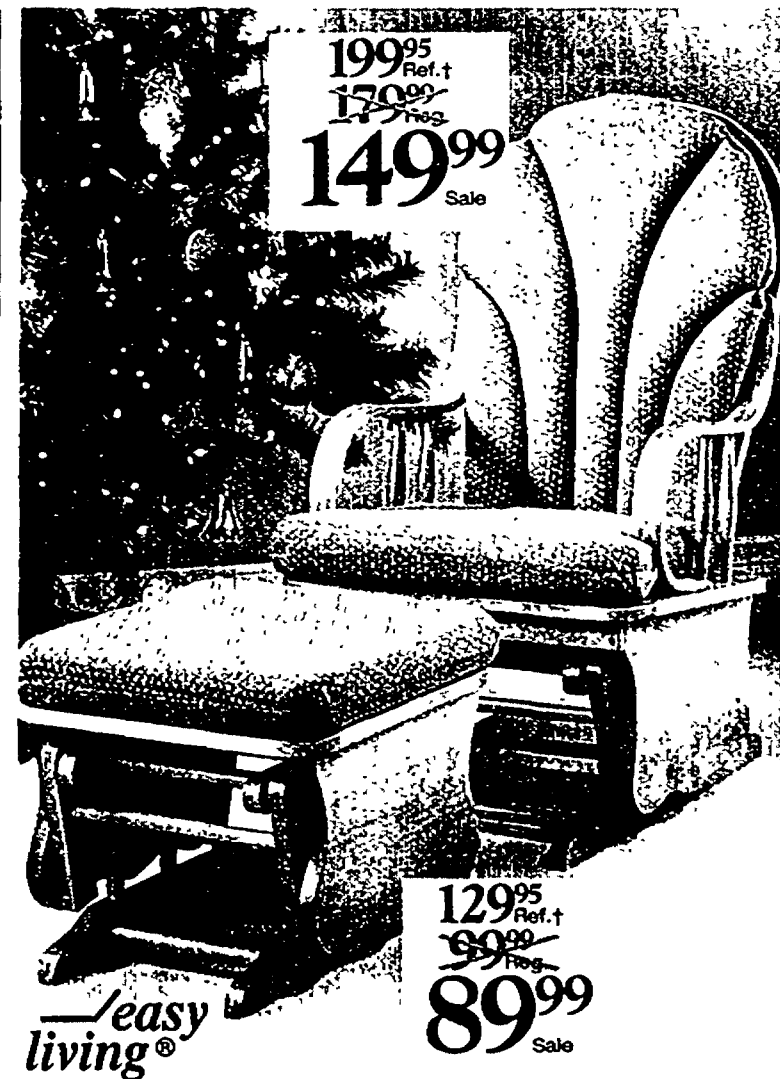

199.95 Ref. †  
~~179.99~~  
149.99 Sale

Easy Living®

129.95 Ref. †  
~~99.99~~  
89.99 Sale

Easy Living® Bentwood Glide Rocker. Oak veneer and solid hardwood. Blue Scotchgard-treated fabric. \*\* 23" W x 21" D x 41" H. 5113F  
Easy Living® Glider Ottoman. 19" W x 19" D x 17" H. 5613F

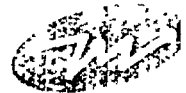

MobileComm

**SMART CHOICE** 2 FREE MONTHS OF LOCAL PAGER SERVICE WITH ANNUAL SIGN UP OF ALL IN STOCK MOBILCOMM PAGERS\*\* Offer Good 10/25-12/31



•Annual pay service plan required

**Motorola Pronto FLX PAGER.** FlexTechnology. Allows up to 5 months of battery life. Improved reliability. 16-number message slots. Message time stamping. Silent vibrations. Saves messages when off. Uses 1 AAA battery. Made in USA. \*\* 5900CMBL Cranberry, 5900TMBL Teal, 5900MBL Black

Your Choice Of 3 Colors  
69<sup>95</sup> Ref.†  
**49<sup>99</sup>\***



**AT&T Digital 900MHz Cordless Telephone With Speakerphone.** Long range secure transmission 10-number memory. Dual key pad Volume control on handset. [E] 9120ABL



**GE 25-Channel Cordless Telephone Answering Machine.** Single microcassette. Voice time/day stamp after each message. Power failure protection. Interactive handset controls and compander noise reduction. [E] 29740EGL

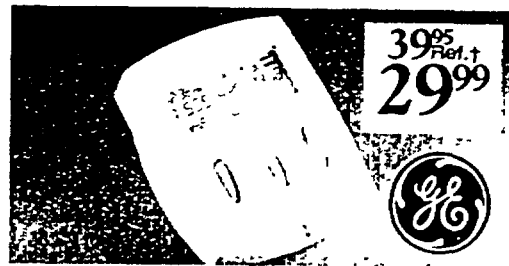

**GE Caller ID Display Model 29030.** 30 names and numbers. 3-line LCD display. Displays number, name, date and time. Includes 2 AA batteries. English, Spanish and French. [E] 29030EGL

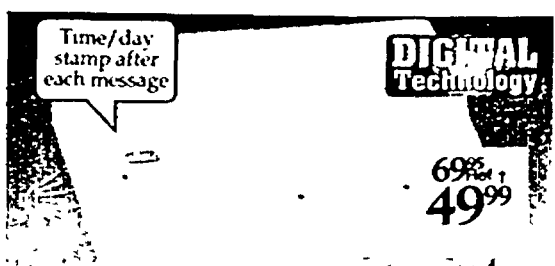

**Phonemate Digital Answering System Model TA120.** Fully digital record 14-minute recording time 2 outgoing messages. Time/day stamp. Speakerphone. [E] 120RPM

# We've Got The Hottest Technology

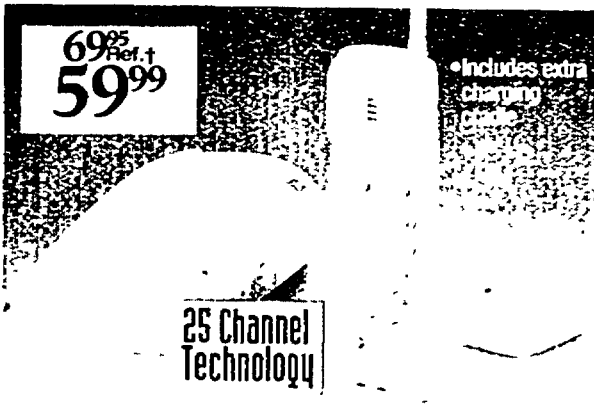

69<sup>95</sup> Ref.†  
**59<sup>99</sup>**

•Includes extra charging cradle

**GE 25-Channel Cordless Telephone With Extra Recharge Cradle Model 2-9752.** Compander noise reduction. Handset volume control. Digital security system. [E] 29752EGL

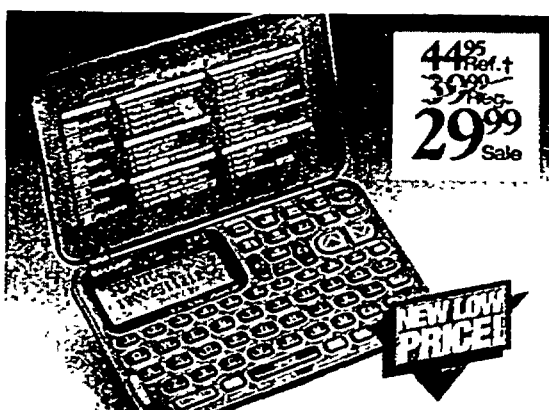

44<sup>95</sup> Ref.†  
39<sup>99</sup> Reg.  
**29<sup>99</sup> Sale**

**NEW LOW PRICE!**

**Sharp Organizer.** 10K memory, 3-line x 14-character screen. Calendar, schedule, telephone, memo pad, expense function, clock and secret password. [E] YO100EFC



**BACK LITE**

59<sup>95</sup> Ref.†  
54<sup>95</sup> Reg.  
**49<sup>99</sup> Sale**

**Royal 80K Organizer With Spell Check.** 80K memory. "Royal Glo" display. Alarm, speller and expense manager functions. Batteries included. [E] RG180RY

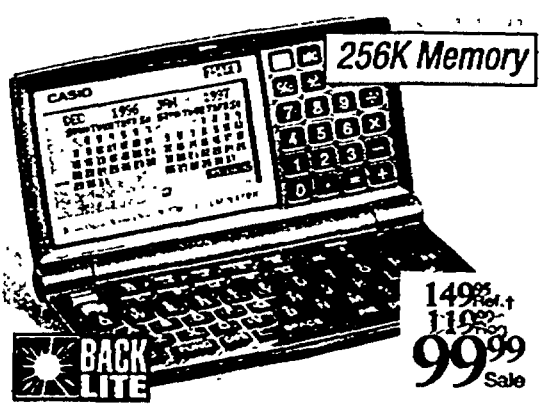

**256K Memory**

149<sup>95</sup> Ref.†  
119<sup>95</sup> Reg.  
**99<sup>99</sup> Sale**

**Casio Boss Organizer Model 256K3.** 26-character x 8-line display. Phone directory, memo scheduler, expense function, alarm and reminder. Batteries included. [E] SF5780ECD



199<sup>95</sup> Ref.†  
**179<sup>99</sup>**

Verbatim 3.5 HD Disks. 20-pack 20V8T \$12.95† Reg. \$10.99

9<sup>99</sup> Sale  
-6<sup>00</sup>  
Mail-in Mkt. Rebate Rebate exp. 12/31/96

**Shop Our New CD-ROM Educational Software Section.** Located in the toy department.

**1. Canon BJC240 Color BubbleJet Printer.** Fast 4 pages per minute monochrome printing at up to 720x360 dpi resolution. Includes Canon Creative 2.0 software. 1-year instant exchange warranty. [E] 240CMP



**0% INTEREST 7 MONTHS NO PAYMENT**

1299<sup>95</sup> Ref.†  
**1199<sup>99</sup>**  
Only \$60 A Month

•Monitor not included

**2. Packard Bell Multi-Media Computer.** 16MB RAM memory, 1.0GB hard drive, 4x CD-ROM drive and 14.4 kbps fax/modem. Speakerphone with answering system and SRS stereo sound. Includes improved software and 1-year warranty. Pentium/120 MHz microprocessor. [E] C110PCK

**Service**  
MERCHANDISE

**MAGNAVOX**  
Smart. Very smart.

Compact Disc

Compact Disc

104<sup>95</sup> Ref. †  
99<sup>99</sup> Reg.  
**89<sup>99</sup>** Sale

109<sup>95</sup> Ref. †  
99<sup>99</sup> Reg.  
**79<sup>99</sup>** Sale

**CD BOOST**  
SYSTEM

**RCA**

**Save \$20**

3. Magnavox Portable CD Boom Box Model AZ834817. Top load CD player. 20-track programming. AM/FM stereo. Dual cassette with high speed dubbing. 3-band graphic EQ. Uses 8 D batteries. \*\* † † CD8348MGN

4. RCA 3-Pc. CD Boom Box Model RP-7976. Top load CD player. AM/FM stereo. Cassette play/record. Detachable bass reflex speakers. Uses 6 D batteries. \*\* † † 7976ERB



**19<sup>99</sup>** Sale  
Sony Lightweight Headphones Model MDRSS. M55ENY \$39.95† Reg. \$29.99

159<sup>95</sup> Ref. †  
149<sup>99</sup> Reg.  
**129<sup>99</sup>** Sale

**Save \$20**



**FREE**  
2 CD SET  
With Purchase  
Of CD505ENY

139<sup>95</sup> Ref. †  
129<sup>99</sup> Reg.  
**119<sup>99</sup>** Sale

6. Sony 3-Pc. CD Boom Box Model CFD-505. Top load CD player. 20-track programming. AM/FM stereo tuner. Stereo cassette. Mega bass. Uses 6 D batteries. \*\* † † CD505ENY

5. Sony Portable Car CD Player Model D242CK. 3-second electronic shock protection. Mega bass. Includes AC adapter, cassette adapter and DC car power cord. † † D242ENY

**Service PLUS... NATIONWIDE SERVICE**  
This means you may buy parts & labor coverage or replacement that starts when the mfr's warranty stops for this item. See stores or call 1-800-435-5826 for details.

*With A Low Price Guarantee*



199<sup>95</sup> Ref. †  
179<sup>99</sup> Reg.  
**149<sup>99</sup>** Sale

**Save \$30**

- 4 sound effect pads
- Auto/multi-finger ACMT
- 20 demo songs

Yamaha Full-Size Keyboard Model PSR185. 2-note polyphonic. 100 AWM voices and style. Uses PA3 AC adapter or 6 D batteries. \*\* † † 185YMA  
Not Shown: Yamaha AC Power Adapter. PA3YMA \$16.95† Your Cost \$14.99  
Not Shown: Deluxe Keyboard Stand. Fits models 185YMA and 77YMA. 8714EJP \$39.95† Reg. \$37.99 Sale \$29.99



149<sup>95</sup> Ref. †  
119<sup>99</sup> Reg.  
**99<sup>99</sup>** Sale

Yamaha Full-Size Keyboard Model PSR77. 49 full-size keys. 100 AWM voices and rhythm styles. Built-in auto harmony and auto sustain voices. Multi-fingering accompaniment. 12-note polyphonic. 20 jam tracks and demo songs. Uses PA3 AC adapter or 6 D batteries. \*\* † † 77YMA

**0% INTEREST, NO PAYMENTS TIL MARCH '97**  
ON STOREWIDE PURCHASES OF \$100 OR MORE

**FREE** Cassette With Purchase Of WM423ENY While supplies last.

Sony Walkman AM/FM Stereo Radio/Cassette. 20 station preset. clock/digital LCD display. \*\* † † WM423ENY



62<sup>95</sup> Ref. †  
50<sup>99</sup> Reg.  
**47<sup>99</sup>** Sale

**SONY.**

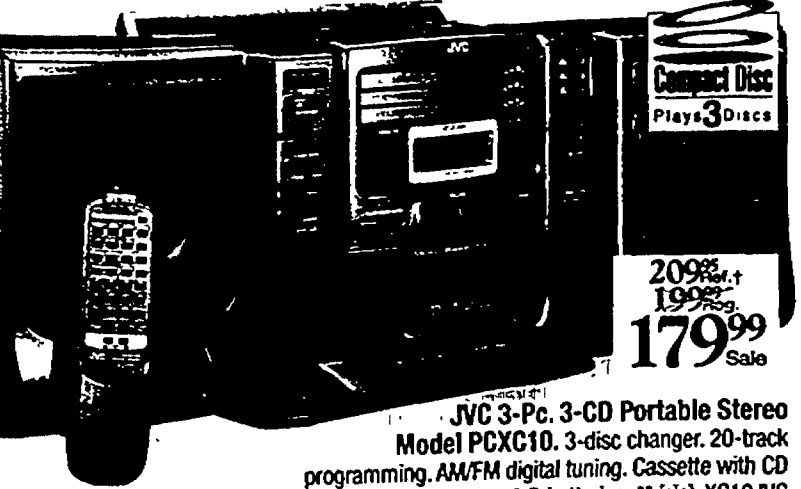

Compact Disc  
Plays 3 Discs

209<sup>95</sup> Ref. †  
199<sup>99</sup> Reg.  
**179<sup>99</sup>** Sale

JVC 3-Pc. 3-CD Portable Stereo Model PCXC10. 3-disc changer. 20-track programming. AM/FM digital tuning. Cassette with CD synchro start. Uses 8 D batteries. \*\* † † XC10JVC

Sony MIDI Shelf System Model LBTD170. 20-watts per channel. 5-disc CD changer. AM/FM digital tuner with 30 presets. 5 preset EQ. Dual cassette decks. 2-way speaker system and remote control. 24Wx15.0x16.7H. † † LB170ENY

\*Pagers require a non-refundable \$20 processing fee payable at time of purchase. The 13th and 14th month are FREE with annual contract purchase. \*\* Batteries not included. Caller ID requires service with local carrier. Available where service is provided. All computer consoles, disks, peripherals, interface cables and accessories sold separately. † † See reference price details on back cover.

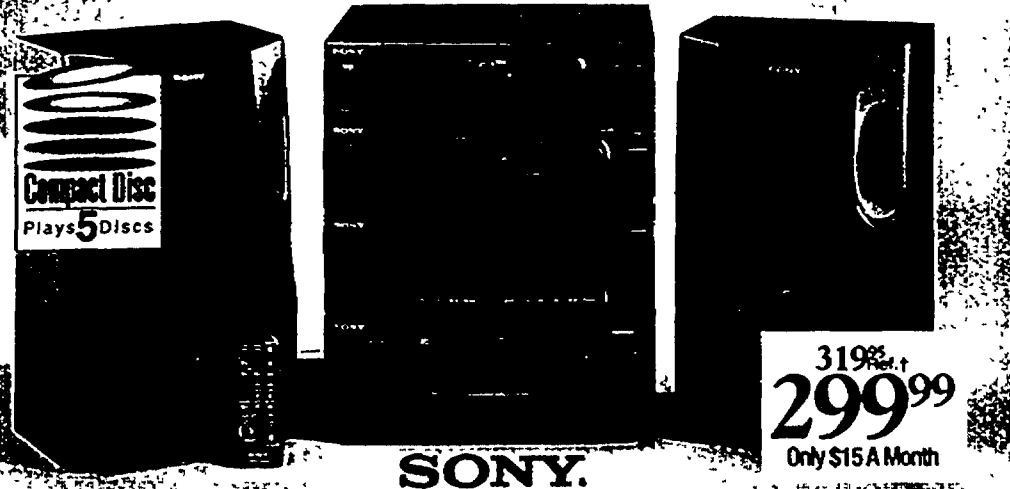

Compact Disc  
Plays 5 Discs

319<sup>95</sup> Ref. †  
**299<sup>99</sup>** Only \$15A Month

**SONY.**

- Ages 4-8 years
- Includes swivel chair, overhead lamp, 2 drawers, marker caddy and more



little tikes

toys that last

Color Crayola

11% Ref.†  
999  
799 Sale



Little Tikes Stencil Assortment. Includes either Carry-Along stencils or Stencil-A-Card set. Made in USA. Each sold separately. 433TRD

109.95 Ref.†  
99.99 Reg.  
89.99 Sale

Little Tikes Creative Art Studio. Gigantic art table is a studio in itself. Includes swivel chair, overhead lamp, 2 drawers, marker caddy and more. Assembly required. Made in USA. 26Wx40Lx30H. 4490TRD

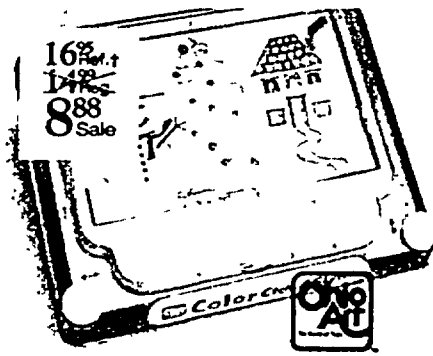

Color Etch-A-Sketch. Includes 6 colored markers and 20 sheets of paper. Ages 4 and up. 559THA



Tyco Magna Doodle Magnetic Drawing Toy. Ages 3 and up. 4801TYC \$15.95†



Phone rings randomly  
•Answering machine with blinking light  
leaves messages

Fisher-Price

54.95 Ref.†  
49.99 Reg.  
19.99 Sale

Fisher-Price Electronic Discovery Desk. Lots of large colorful buttons. Ages 9 to 36 months. Uses 4 AA batteries \* 71115FP

# We're Your Source For Savings On

**TOY CLEARANCE**  
Save 10% - 70% OFF  
THE ORIGINAL PRICE \*\*  
ON ALL GREEN  
TAG TOYS



Fun Park. Includes 2 cars and 3 little people figures. Ages 1½ to 5 years. 72560FP

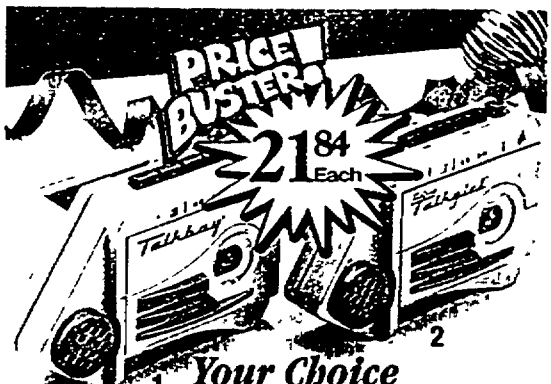

Tiger Deluxe Talkboy Or Talkgirl. Features voice change, slow-motion switch, retractable microphone. Includes 30-minute tape. Uses 4 AA batteries. \*  
1. Deluxe Talkboy. 83506TEA \$34.95†  
2. Deluxe Talkgirl. 83509TEA \$34.95†



Vtech Smart School Yard. Teaches time, letters, numbers, spelling, colors and more. LED light flashes with friendly voice and 10 built-in melodies. Ages 2½ to 5 years. Uses 4 AA batteries. \* 2275VDL

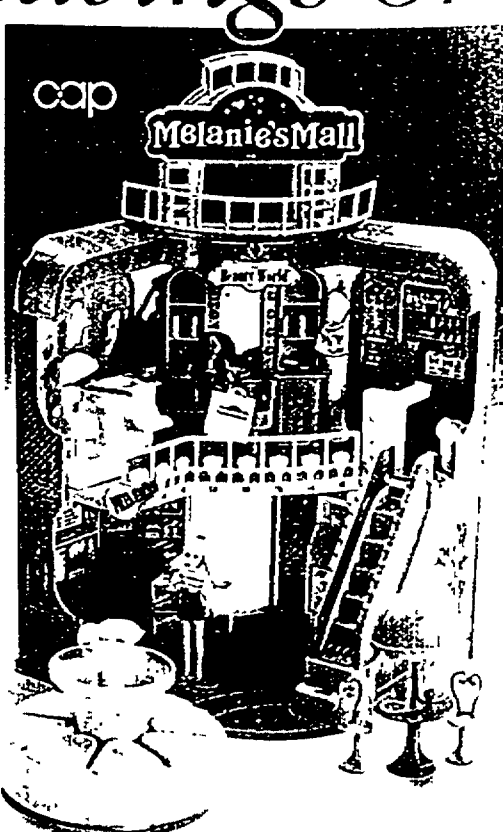

Melanie's Mall: Main Mall. Real working fountain, revolving door and escalator. Includes Melanie doll. Ages 4 and up. 5400CPY

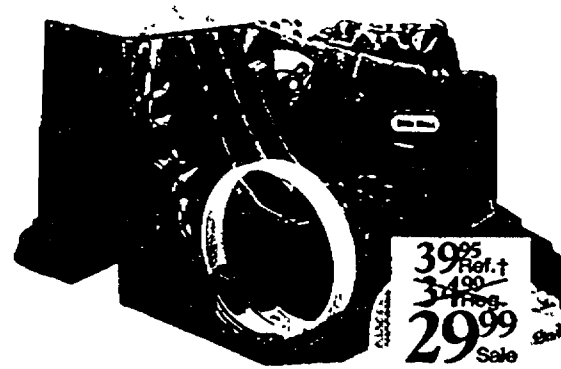

Little Tikes Adventure Mountain Raceway. 6 race tracks, 2 die cast cars and more. Ages 6 and up. Cars included. Storage compartment. Made in USA. 401TRD



Kenner Easy-Bake Oven. Ages 8 and up. 65510KE \$21.95†



60th Anniversary Monopoly. Special numbered and dated edition. 2-8 players. Ages 8 to adult. 40001PB

\*Batteries not included. \*\*Original price on clearance merchandise sold in Service Merchandise stores and/or catalogs during 1995/1996. Intermediate markdowns have been taken. †/† See reference price details on back cover.

Indian Industries, Inc.

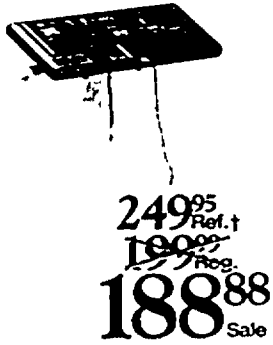

249<sup>95</sup> Ref.†  
~~199<sup>99</sup>~~  
188<sup>88</sup> Sale

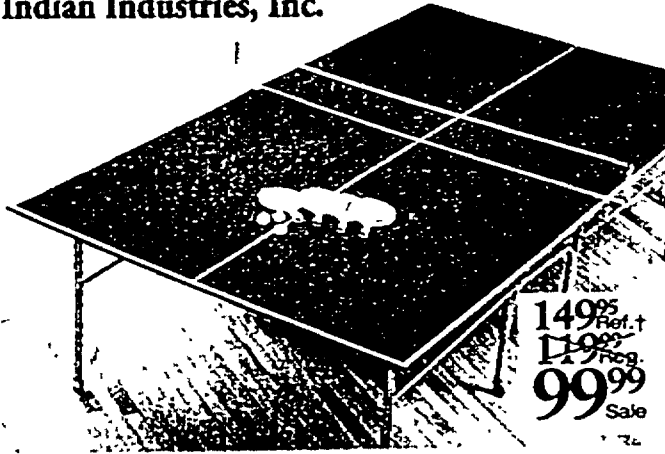

149<sup>95</sup> Ref.†  
~~119<sup>99</sup>~~  
99<sup>99</sup> Sale

"Avenger" Table Tennis Table. Playback table. Fold and roll for easy storage. 5/8" top. 1" steel tubular chassis. 2" casters. 1" self-opening U-leg design. Net and posts not included. Made in USA. T8014UT



See Our 96/97 Jewelry, Gift And Home Catalog For Additional Basketball Equipment.

139<sup>95</sup> Ref.†  
~~109<sup>99</sup>~~  
119<sup>99</sup> Reg.  
99<sup>99</sup> Sale

Lifetime Products Open Court Portable Basketball System. Black telescopic pole adjusts to 6 positions, from 7'-10'. Made in USA. 1208LPD

1-And 2-Day Rush Delivery In Time For Christmas! Order By Noon EST, Dec. 20. Call Toll-Free 1-800-251-1212.

Weslo Cadence 805 Treadmill. Great for walking. Features a durable DC motor for a smooth, continuous pace. Single-window electronics display speed, workout time, distance and calories burned. Training zone. SafeStart tether. Made in USA. F-12 8055WTT



WESLO™  
Winning Exercise Solutions™



39<sup>95</sup> Ref.†  
~~29<sup>99</sup>~~  
26<sup>99</sup> Sale

Seneca "Street Lites" In-Line Skate Combo Pack. Includes skates, wrist guards, elbow pads and knee pads. Foam padded lining with lace and buckle closure. Padded tongue, 60mm wheels and dual heel brakes. 7820KEW02TCT Size 2 Also Available In Sizes 3-6

# Indoor Or Outdoor Fun



29<sup>95</sup> Ref.†  
~~24<sup>99</sup>~~  
19<sup>88</sup> Sale



Black & Decker Snake Light. Flexible core. High-intensity xenon bulb. High-impact ABS. 2 C batteries included. SLB1MBDK

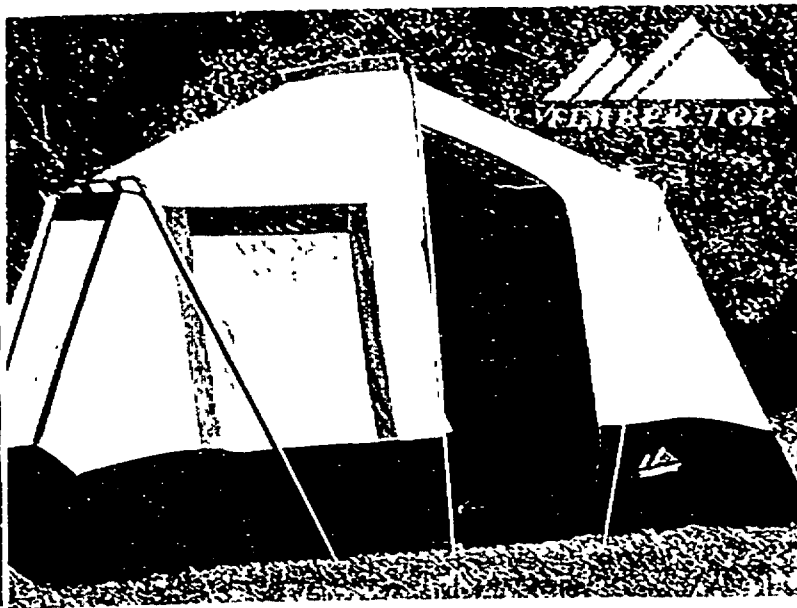

149<sup>95</sup> Ref.†  
~~129<sup>99</sup>~~  
99<sup>99</sup> Sale

Timber Top® 8x12' Two-Room Cabin Tent. Sleeps 5 adults. Divider zips to form two 6x8' rooms for privacy. Ridge-style poles are shock corded for easy assembly. Three large windows, D-style door with "no-see-um" screen. Polyester/canvas roof, nylon taffeta walls, polyethylene floor. Includes carry bag. 136HK



SPECIAL BUY

34<sup>95</sup> Ref.†  
~~29<sup>99</sup>~~  
19<sup>99</sup> Sale

Queen Size Air Bed. Heavy vinyl construction for strength and comfort. Easy-fill valve. Great for guests and kids. 78Wx65Dx57H. 147HK

99<sup>95</sup> Ref.†  
~~79<sup>99</sup>~~  
59<sup>99</sup> Sale

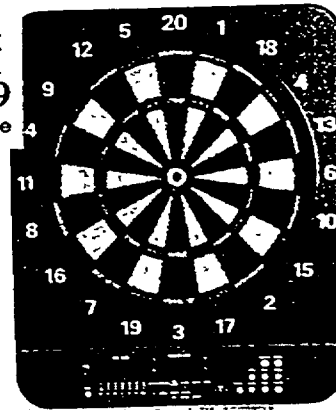

Sportcraft 4-Player New Promotional Cricket Dartboard. Regulation 18" soft tip dartboard. Automatic scoring for up to 4 players. Games include: 301-1001, Count-up 100-1000, Shoot-out, Cricket, Round-the-Clock and Hi-Score. Includes 6 darts, spare tips, AC adapter and rules. 79070GK

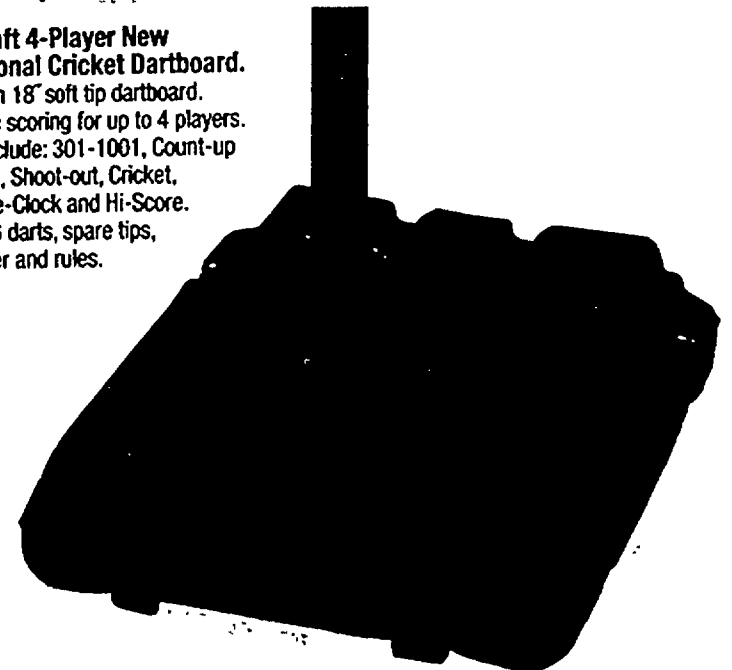

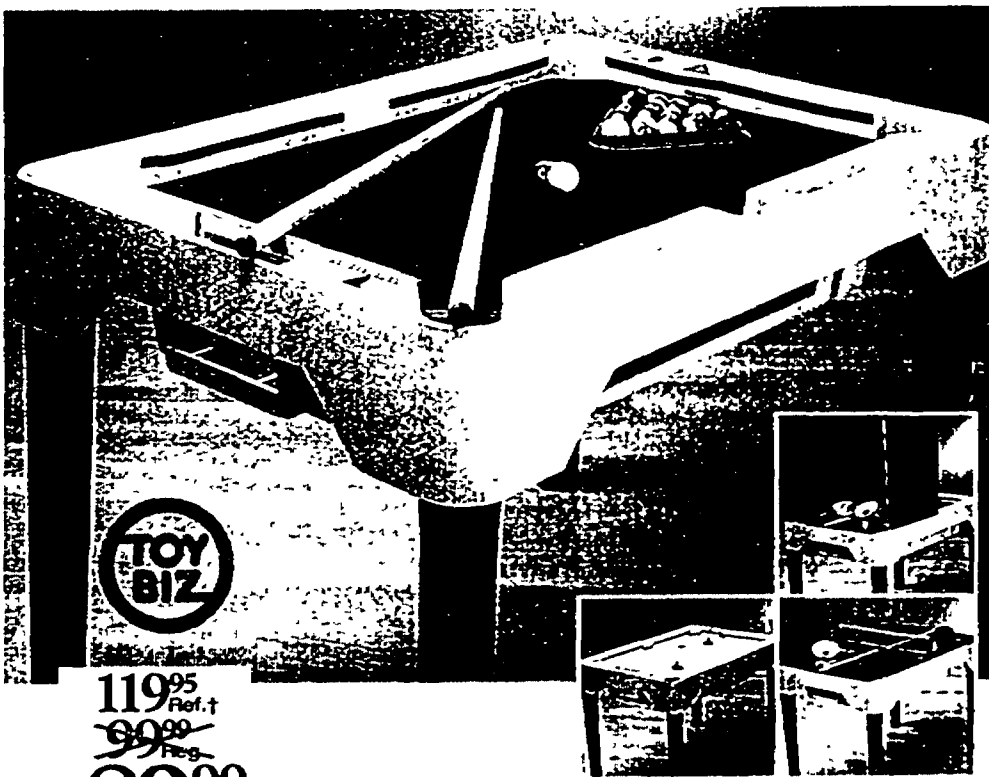

**TOY BIZ**

119.95 Ref. †  
99.99 Reg.  
**89.99** Sale

**Toybiz 4-In-1 Game Table.** Games include pool, table tennis, knock hockey, and racquetball. Easy to assemble and store. 53021TBZ



**STAR WARS**

**PRICE BUSTERS**  
**16%**

**Star Wars Lightsaber.** Famous Jedi Knight weapon. Choose from red or green sabers. Uses 2 C batteries. \* 69600KE \$21.95†

34.95 Ref. †  
27.99 Reg.  
**19.99** Sale

79.95 Ref. †  
69.99 Reg.  
**59.99** Sale

**Super Value**

**Recliner "Body Comfort" Electronic Massage Seat/Totter**

**25" MAGNAVOX**  
Smart, very smart.

279.95 Ref. †  
259.99 Reg.  
**239.99** Sale  
Only \$12 A Month

**Magnavox 25" Color TV Model PR2501C.** 20-key remote, 181-channel cable ready, bilingual on-screen menu, sleep timer. Channel edit. 24"Wx20"Dx22"H. \*\* ESR 2501MGN



22.95 Ref. †  
19.99 Reg.  
**17.99** Sale  
Each

**101 Dalmatians Plush Assortment.** Each sold separately. 15949MT



**PRICE BUSTERS**  
**59.92**  
**-7.00**  
Mail-in Mfr. Rebate  
Rebate exp. 12/1/96

**TYCO**

**Tyco 6V Jet Turbo Dagger.** Hi-tech 3-wheeled dragster with adjustable stunt shifter. Programmable to 6 stunts. Burnouts, wheelies, 360's and more! Uses a 6V rechargeable battery pack with charger. \* 2859TYC \$74.95† ..... **Your Cost \$59.92**  
**Tyco 6V Battery Pack And Charger.** For Tyco radio-control 6V systems. 2990TYC \$24.95† ..... **Your Cost \$19.99**

\*Batteries not included. \*\*Some cable companies may require the use of a converter box with your cable ready set

**Extended Holiday Hours:**  
Friday, Nov. 29th and Saturday, Nov. 30th from 7 AM to 10 PM;  
Sunday, Dec. 1st from 10 AM-7 PM

**Ann Arbor, MI**  
3531 Washtenaw Ave.  
in Arborland Mall  
(313) 971-3022

**Dearborn, MI**  
5701 Mercury Dr.  
off Southfield Freeway  
at Ford Rd.  
(313) 441-2300

**Flint, MI**  
5038 Miller Rd. Suite A  
Opposite Genesee Valley Ctr.  
(810) 733-7880

**Lansing, MI (2)**  
5801 West Saginaw Hwy.  
at Mall Dr. in the  
Delta Center Shopping Plaza  
(517) 323-0944

**(Okemos)**  
1982 East Grand River Ave.  
in Meridian Mall  
(517) 349-6600

**Livonia, MI**  
29751 Plymouth Rd.  
and Middle Belt  
in Wonderland Mall  
(313) 513-5070

**Novi, MI**  
43635 West Oaks Drive  
across from  
Twelve Oaks Mall  
(810) 348-8970

**Roseville, MI**  
28794 Gratiot Ave.  
at 12 Mile Rd.  
(810) 772-5858

**Southfield, MI**  
29712 Southfield Road  
between 12 & 13 Mile Roads  
(810) 559-6000

**Southgate, MI**  
13851 Eureka Road  
4 miles east of Southland  
Mall at Trenton Rd.  
(313) 281-0160

**Sterling Heights, MI**  
44725 Schoenherr Road  
at SW corner of Hall Rd.  
across from Lakeside Mall  
(810) 254-2200

**Troy, MI**  
600 John R. Road  
at 14 Mile Rd.  
across from Oakland Mall  
(810) 585-9590

**Waterford, MI**  
245 North Telegraph Road  
behind Hudsons  
in Summit Place Mall  
(810) 738-5700

**Westland, MI**  
7365 Nankin Blvd.  
1/4 mile west of Wayne and  
Warren intersection  
west of Westland Mall  
(313) 525-6600

†COMPARATIVE PRICES ARE A GUIDE FOR THE RANGE OF NATIONAL, NON-DISCOUNT SELLING PRICES AND MAY CHANGE. ‡ Indicates the Mfr.'s Suggested Price. † indicates non-discount price for identical or on comparable product. Comparative prices are not our present or former price. See stores for details. Payments for Service Merchandise charge plan, rounded to nearest dollar, based upon no outstanding balance. Sales tax not included. MONTHLY PAYMENT IS \$10 MINIMUM OR 5% OF UNPAID BALANCE WITH A 21.96% APR. ESR ServicePlus parts & labor coverage or replacement available. See stores or call 1-800-435-5826 for details. Our policy is to have advertised item readily available. If a shortage occurs, we will issue a backorder or other a substitute of equal value. Some items are not available by mail, check Mail Order Assistance for availability. We Reserve The Right To Limit Quantities. For warranty info, check your local store, or write: P. O. Box 25130, Nashville, TN 37202.

**0% Interest! Buy Now, Pay Later!** When you use your Service credit card, purchases may not be billed (posted) to your account until the month as stated in the offer ("Deferred Billing Month"). Deferred billing purchase(s) may not appear on the periodic statement until the Deferred Billing Month, at which time FINANCE CHARGES, required payments and fees related to the deferred purchase(s) will again apply. Prior charges, if any, or new purchase(s) not deferred, if any, will continue to be billed as normal with all terms of the Agreement applicable thereto. Monthly payment is \$10 minimum or 5% of unpaid balance with a 21.96% APR. See stores for complete details. **LOW PRICE GUARANTEE**-If you should find a lower, current, advertised price on the identical, name-brand, in-stock product we will refund the difference within 30 days of your purchase from us. Competitor's ad required. Competitor's retail store must be within 25 miles. We will not match prices for close-out, discontinued, floor samples, free or distressed products, mail order catalogs, liquidators, salvage stores, wholesalers and the like, percent-off ads, or our products which are not in inventory. X

We accept...

**Service**  
MERCHANDISE

To order by mail or for a store near you, call any time  
**1-800-251-1212** (En Español 1-800-992-4479)  
<http://www.servicemerchandise.com>

©1996, Service Merchandise  
We Reserve The Right To Limit  
Quantities. All photographic, clerical  
typographical and printing errors  
subject to correction

PRINTED IN U.S.A.

Great prices to get your

holiday shopping off right!

# holiday day<sup>2</sup> kickoff SALE

FRIDAY & SATURDAY, NOV. 29-30 ONLY!

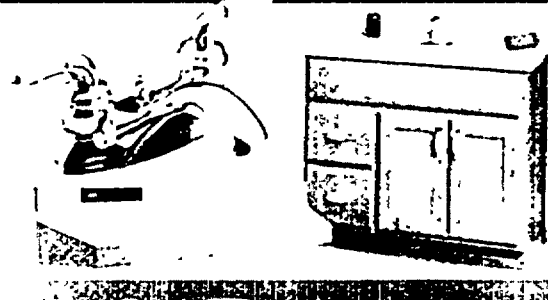

## 10% OFF

all hand & power tools

## 10% OFF

all kitchen and bath

## 10% OFF

all live holiday goods

Give the do-it-yourselfer on your list the gifts they really want!

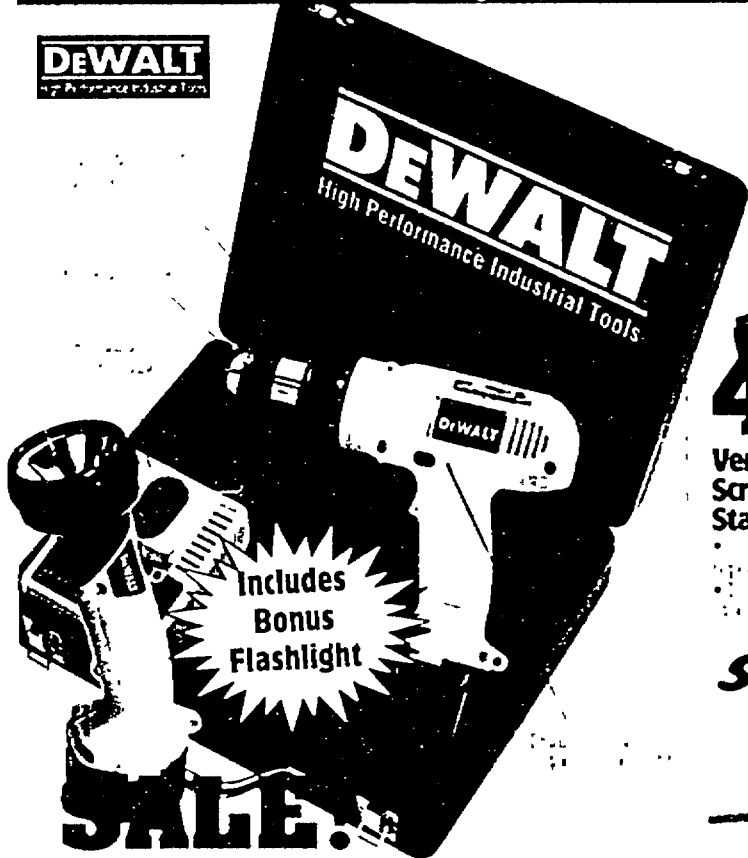

# 125<sup>10</sup>

Reg. 139.00

### 9.6V Heavy Duty Cordless Drill/Driver & Flashlight

- Flashlight w/ 90° swiveling head 3 hr continuous runtime • Includes two 9.6V batteries and carrying case
- 1401622



# 44<sup>89</sup>

SALE! Reg. 49.88

### VersaPak 3.6v Cordless Screwdriver/Snakelight™ Starter Kit

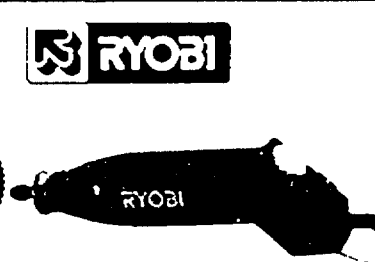

# 26<sup>10</sup>

SALE! Reg. 29.00

### Variable Speed Multi-Tool

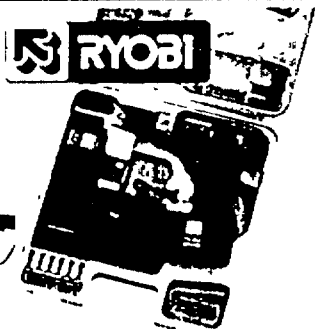

# 134<sup>10</sup>

SALE! Reg. 149.00

### 14.4V Cordless Drill/Driver Kit



# 53<sup>10</sup>

SALE! Reg. 59.00

### Classic 2.5HP 7-1/4" Circular Saw

- Ball bearing power motor • Easy to lock off switch • Includes 9" Skil Super™ carbide blade • 1427912

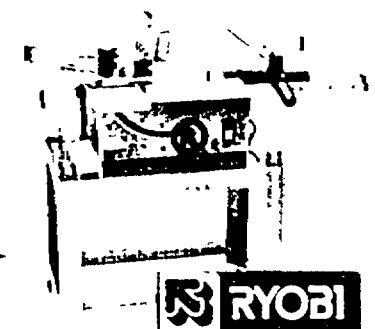

# 438<sup>30</sup>

SALE! Reg. 487.00

### Table Saw w/Stand

- 15 Amp 1500 watt motor • 3600 RPM • Includes sturdy heavy duty metal stand • Includes 10" 80 tooth carbide tipped blade • 1427910



# 8<sup>98</sup>

SALE! Reg. 9.98

### Durex Assorted 4-Piece Plier Sets

- Set includes 4 different sized pliers • 1401622

**FREE**  
Kitchen & Bath information startup packet. Call now  
**1-800-766-1235**



The place for  
**Holiday savings**



Give a holiday gift certificate  
As valid as cash for all merchandise

# Over 500 Trim-A-Tree items for the Holidays

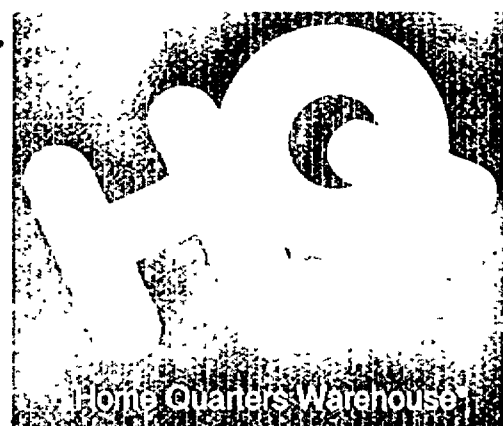

Decorations...  
to light up the night!

**28<sup>49</sup>**  
YOUR CHOICE  
Lighted 40" Santa or 40"  
Snowman Lawn Figures  
35" Teddy Bear..... 24.99

**20% OFF**  
All Ceramic  
Dickensvale Collectables  
\*Includes 1000+ items for sale  
at all locations.

**1.99 SALE!**  
Reg. 2.49  
100 Clear or Multi Lite Set  
\*UL Listed \*Indoor/Outdoor use  
\*Total Length = 34 ft \*Spare bulbs and  
fuses included (4267373/4267381)

**2.63 SALE!**  
Reg. 3.29  
6" Candler  
\*Brass \*On/Off switch (661275)

**30% OFF**  
All Wrapping  
Paper, Ribbons,  
Bows & Tags



See our  
wide selection  
of artificial  
trees!

**29<sup>99</sup> SALE!**  
Reg. 39.99  
24" 3D Feeding or  
Standing Deer w/Lites  
\*24" x 14" x 19" as shown ground wire \*No lock  
\*Set up instructions \*Easy to assemble (427904)  
48" Feeding or Standing  
Deer with Lite Reg. 59.99.....Sale 49.99

**36.99 SALE!**  
Reg. 39.99  
Miller's Tree of Light  
\*Standard 40" tree \*6' tall  
\*Lighted tree (4268843)

**81.99 SALE!**  
Reg. 85.99  
Santa In Sleigh  
Lawn Figure

**64.99 SALE!**  
Reg. 69.99  
3 Piece Nativity  
Lawn Figure Set (4213377)  
3 Pc. Wiseman Set (4213385)  
Reg. 79.99.....Sale 74.99

## Ornaments & Novelties

**6.49**  
Reg. 6.99  
Disney Winter Wonderland  
Ornaments  
\*Made by Korus

**4.19**  
Reg. 4.49  
Assorted Glass  
Tree Ornaments  
\*4 1/2" x 1 1/2" \*Assorted colors  
\*2" x 1 1/2" \*Assorted colors  
\*2" x 1" \*Assorted colors

**1.99**  
Reg. 2.29  
Small Red  
Velvet Bows  
\*2 loop \*12 pins

**5.49**  
Reg. 5.99  
Hudson Garland  
\*4' x 18" \*Assorted colors  
\*2" x 18" (5626130)  
Reg. 2.88...Sale 2.59

**10% OFF**  
Assorted Picks  
\*4 styles to choose from \*Great for  
making your own decorated wreath

**8.99**  
Reg. 9.99  
9' Tree Decorating Pole  
\*Reach thru high spots on your  
Christmas tree effortlessly (425816)

**169<sup>99</sup>**  
Reg. 179.99  
7-1/2' Tuscany  
Frosted Fir

### More Artificial Trees

**74.99** 7' Winter Green Fir  
Reg. 79.99

**89.99** 7' Silver Queen Fir  
Reg. 99.99

**89.99** 7' Kennedy Fir  
Reg. 99.99

**139.99** 7-1/2' Tiffany Fir  
Reg. 149.99

**189.99** 9' Kennedy Fir  
Reg. 199.99

**109<sup>99</sup>**  
Reg. 119.99  
7-1/2' Douglas Fir

**179<sup>99</sup>**  
Reg. 189.99  
7-1/2' Bristle Pine Cone Tree

**27.99**  
Reg. 29.99  
Revolving  
Tree Stand

**42.97**  
Reg. 44.97  
Heavy Duty  
Steel Tree Stand

**18.99**  
Reg. 19.99  
Dickensvale Train Set  
Logyer Bear Train (4498903)..... 36.99

## Tabletop Trees

Many styles at  
unbeatable prices

**9<sup>49</sup>**  
Reg. 9.99  
2' Pine Cone Berry  
Tabletop Tree

**15.99** 2' Bristle Cone Tree  
Reg. 18.99

**47.99** 4-1/2' Winter Green Fir  
Reg. 49.99

**14.29** 3' Green/ Blue/ White Tree  
Reg. 14.99

**9.49** 2' Lited Canadian Pine Tree  
Reg. 9.99

**9.49** 3' Lited Canadian Pine Tree  
Reg. 9.99

## Lightsets....

**5.99 SALE!**  
Reg. 6.79  
Westinghouse 100-Light  
Add-A-Set Light Set  
\*Full range speed control Set remains  
lit if one goes out \*Clear or multi  
Solid Color 140-Light Set  
\*3 function wall console \*MS950%

**7.49 SALE!**  
Reg. 7.99  
Heavy Duty 100-Light  
Add-A-Set Light Set  
\*Connect a maximum of 6 heavy  
duty sets together \*Clear or multi

**10.99 SALE!**  
Reg. 11.99  
Westinghouse  
140-Light Chasing Light Set  
\*Full range speed control Set remains  
lit if one goes out \*Clear or multi  
Solid Color 140-Light Set  
Reg. 12.99.....Sale 11.99

**7.49 SALE!**  
Reg. 7.99  
Westinghouse  
Easy Clip Light Set  
\*100 lights \*Clear or multi  
\*Cap holds bulb in any position

**SUPER-HOT PRICES to help get your home ready for the holidays!**



**9<sup>99</sup> SALE!**  
Reg. 11.99  
Pine Mountain  
Fire Logs  
\*Each case contains six 5lb logs



**79<sup>c</sup>**  
SALE!  
Reg. 1.19  
1 Gallon Windshield  
Washer Fluid  
\*Limit 12 per customer



**42<sup>99</sup>**  
SALE!  
Reg. 49.99  
Radiant Quartz Heater  
with Humidifier  
\*Fastest air flow for quicker room heating  
\*Exceeds U.S. safety standards (4270500)

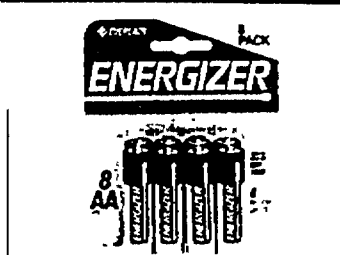

**3<sup>77</sup> SALE!**  
Reg. 4.19  
Eveready AA Battery  
8 Pack

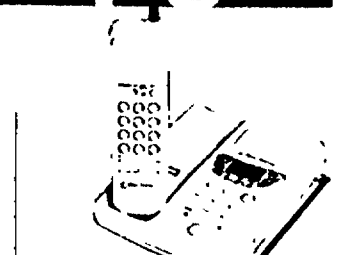

**98<sup>99</sup> SALE!**  
Reg. 109.99  
Northwestern Bell  
25 Channel Cordless  
Phone/Answering Machine  
\*White \*Digital answerer  
\*9M memory \*Last # redial (3356128)



**\$11**  
SALE!  
Reg. 14.84  
Two-Step  
White Step Stool  
(22-1704)



**9<sup>77</sup> SALE!**  
Reg. 17.99  
300 Watt Halogen  
Torchlight Lamp  
\*Semi-gloss finish available in  
Black, White, Funtio green or  
taupe \*#703 \*Matte finish  
available in charcoal, saxe,  
cranberry or linen \*#704  
\*Includes bulb

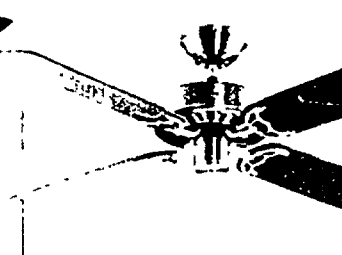

**49<sup>99</sup> SALE!**  
Reg. 64.99  
Hunter 44" Potomac  
\*Antique Brass \*Available in bright  
brass and white \*#21610  
52" Potomac Reg. 69.99...Sale 54.99



**\$179 SALE!**  
Reg. 199.00  
1/2 HP IntelliCode™  
Garage Door Opener  
\*Solid steel screw drive "IntelliCode"™  
system changes your radio access code  
with each use \*Includes 2 remotes  
\*3 function wall console \*MS950%

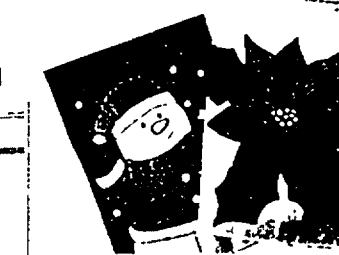

**9<sup>99</sup> SALE!**  
Reg. 12.98  
Seasonal Design Flags  
\*28" x 40" applique flags  
\*Choose from holiday  
or traditional designs  
Silkscreen & Mini Flags... 15% Off

2 Days to Save on Holiday Decorating Plus HOT BUYS on Gifts and Last Minute Holiday Fix-Ups!



★ 2 Days to Save on Holiday Decorating ★ Plus HOT BUYS on Gifts and Last Minute Fixturs! ★

Great prices to get your holiday shopping off right!

# holiday day kickoff SALE

**FRIDAY & SATURDAY, NOV. 29-30 ONLY!**

## 10% OFF

all poinsettias, trees, wreaths & roping



**SALE!**  
**2.99**  
Reg. 3.33

**Poinsettia 6" Pot**

• 10-12" • 1-2" stems  
• Choose from assorted colors  
4" reg. 1.97..... 1.77



**26<sup>97</sup>** SALE!  
Reg. 29.97

**6' - 8' Fraser Fir**

- Dark, blue-green needles with silver undersides
- Good needle retention
- Excellent evergreen fragrance
- Sturdy branches
- Great for a vast assortment of decorations



**6<sup>17</sup>** SALE!  
Reg. 6.86

**White Pine Roping**



**8<sup>87</sup>** SALE!  
Reg. 9.86

**22" Mixed Fraser Fir Wreath**



**9<sup>87</sup>** SALE!  
Reg. 10.97

**2' Table Top Fraser Fir**



**17<sup>96</sup>** SALE!  
Reg. 19.96

**6' - 8' Douglas Fir**

- Dark green needles with silver undersides
  - Excellent evergreen fragrance
  - Sturdy branches
  - Great for a vast assortment of decorations
- 6' - 8' Natural Balsam reg. 10.86..... 9.77



**13<sup>37</sup>** SALE!  
Reg. 14.86

**5' - 7' Scotch Pine**

- Dark green needles with silver undersides
- Excellent evergreen fragrance
- Sturdy branches
- Great for a vast assortment of decorations



The place for

# Holiday savings

And don't forget...shop now for

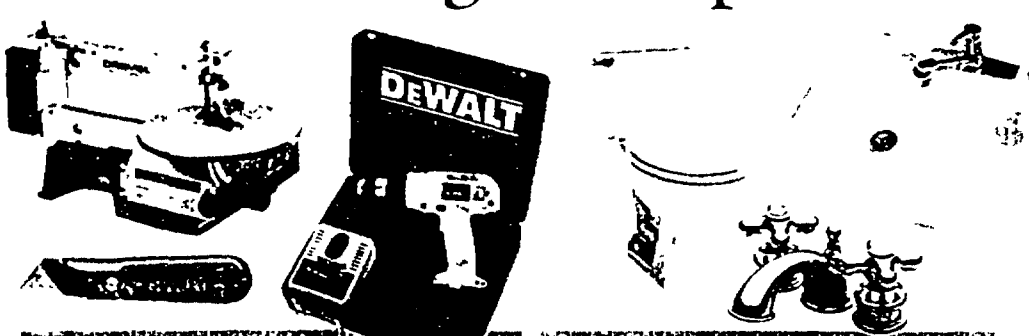

**10% OFF**  
all hand & power tools

**10% OFF**  
all kitchen and bath

**10% OFF** Any Lower Advertised price!

It's our way of guaranteeing you the lowest prices every day, no ifs, ands or buts! If you ever find one of our items at a lower price anywhere else, just let us know. We'll verify that price then we'll not only meet it, we'll give you an additional 10% OFF!

ROSEVILLE 810-772-2633  
 LYONIA 313-513-7545  
 LYONIA/HAGGERTY ROAD 313-432-1200  
 MADISON HEIGHTS 810-588-0805  
 SOUTHGATE 313-246-2866  
 YPSILANTI 313-973-0035  
 BLOOMFIELD 810-335-8331

Store Hours Mon.-Thurs 7am-9pm • Fri. 7am-10pm • Sat 7am-9pm • Sun. 8am-6pm  
 Copyright 1996 - All Rights Reserved

After Thanksgiving  
**2 DAY SALE**

Extended Hours:  
SHOP FRIDAY, NOV. 29,  
7am-11pm;  
SATURDAY, NOV. 30,  
8am-11pm

**EARLY  
BIRD  
SPECIALS**

**Friday Only 7am-11am**

See pages 2-3.

**40**

**BONUS  
BUYS**

**Friday Only**

See pages 4-6.

Mickey's  
**Magic  
Christmas!**

This Mickey Mouse holiday plush toy—  
available exclusively at Kohl's—is just  
\$12.99 with any \$30 purchase.  
While supplies last. Reg. \$25.99

©DISNEY



**KOHL'S**

*That's more like it.*

112811

Mickey's  
Magic  
Christmas!



DISNEY

This Mickey Mouse holiday plush toy- available exclusively at Kohl's. Just \$12.99 w/any \$30 purchase. While supplies last. Reg. \$25.99

## Win a Trip to Walt Disney World

Win a magical family vacation for four! Package includes airfare, hotel accommodations and tickets to Walt Disney World in Orlando, Florida.

No purchase necessary. See store for details.

## Win a \$500 Shopping Spree

One winner per store. See store for details.

### Extended Store Hours

Fri., Nov. 29, 7am-11pm;  
Sat., Nov. 30, 8am-11pm

# EARLY BIRDS

3<sup>77</sup> ea.

3½-gallon 3-way popcorn tins. 18 designs exclusive to Kohl's. Reg. 9.99 ea. Limit 10 tins per customer

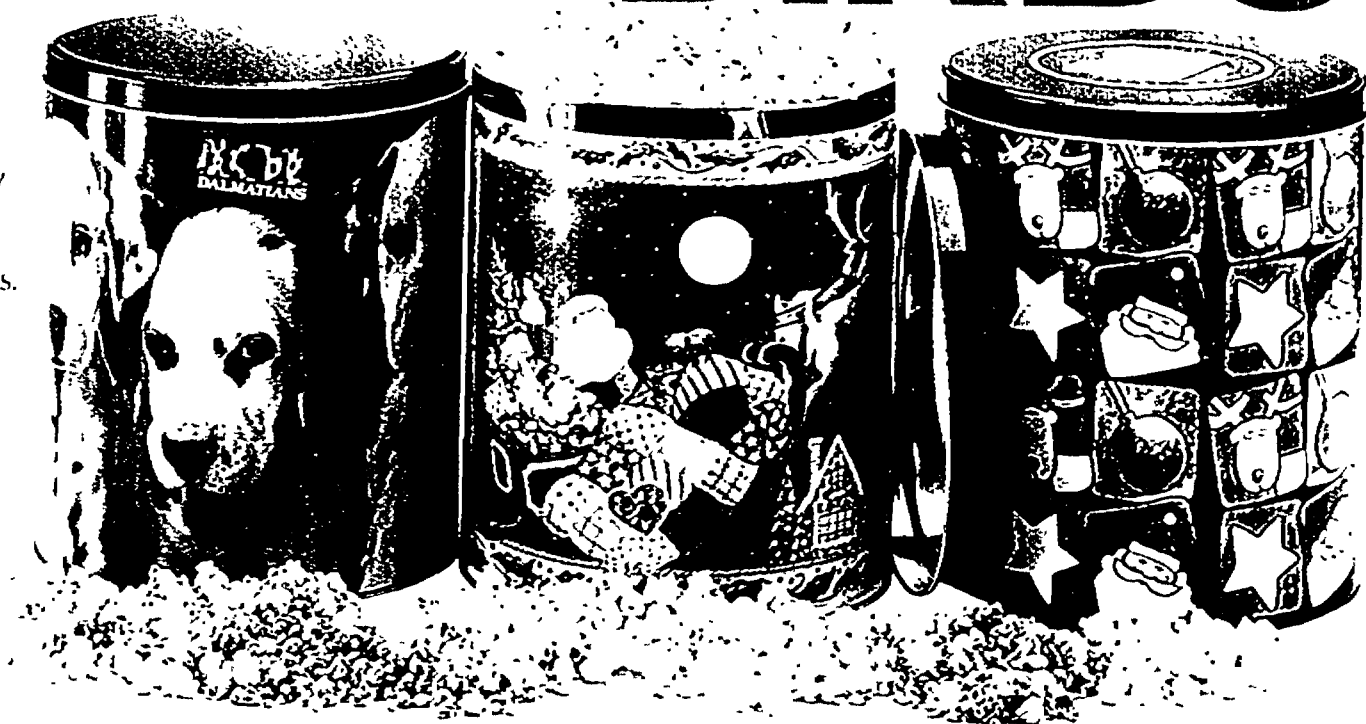

CROFT & BARROW.

17.99

35% off misses' Croft & Barrow® ribbed mock-neck sweaters. Many colors; colors may vary. Reg. \$28



37.99 Your Choice

Men's or women's Reebok® Comfort Glide walkers. Women's available in wide widths. Reg. 59.99 pr.

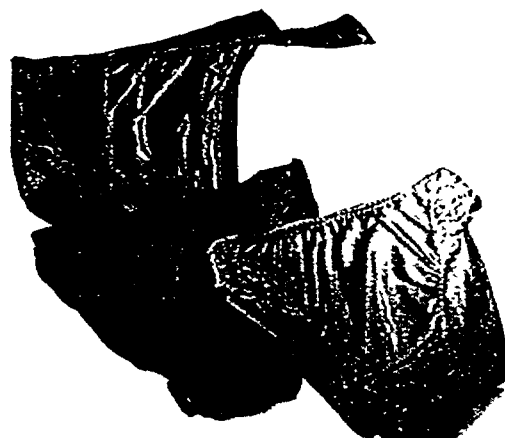

save 50%

Selected panties. From Vanity Fair, Bali®, Moments® & more. Reg. 3/10.50 to 9.00 ea., sale 3/5.25 to 4.50 ea. Excludes jockey.

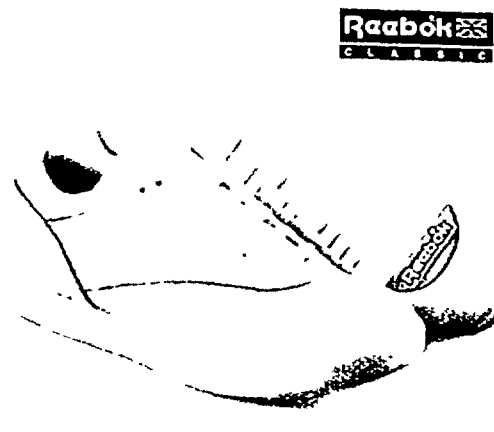

27.99

Women's Reebok® Monaco. Garment leather shoes. Reg. 44.99  
Kids' Reebok® Princess, sale 18.99

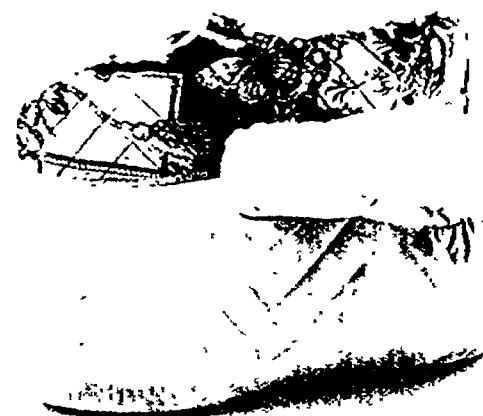

5.99

40% off women's quilted chintz warm-up boots. Incredible price! In solid colors or prints. Reg. 9.99



29.99

50% off an AB Toner™. Exercise ab muscles without stress to the neck or back. Video included. Reg. 59.99

# FRIDAY 7AM-11AM ONLY



**60% Off** PLUS TAKE AN EXTRA 10% OFF  
 Entire stock 14k gold chains and bracelets.  
 Reg. \$50-\$800, sale \$20-\$320; less 10%, final price \$18-\$288



**26.99** Juniors'  
 Levi's® denim jeans. Reg. 39.99  
 Other Levi's® denim jeans.  
 Reg. 44.99, sale 28.99



save **35%** Juniors'  
 Sweaters. Including novelty, chenille,  
 cotton, fur-blends and more. Reg.  
 21.99-49.99, sale 14.29-32.49



- Space Jam
- Healthtex
- OshKosh B'Goin'
- 101 Dalmatians
- Pooh
- More!



**13.99** Men's  
 Bugle Boy® 705 & 750 denim jeans.  
 Bugle Boy® Gold Crest jeans, 18.99  
 Boys' 8-20 Bugle Boy® jeans, 12.99



**11.99** Boys' & Girls'  
 Boys' 4-20 & girls' 4-16 Sonoma  
 denim jeans. Reg. \$17-\$19  
 Infants' & toddlers', sale 8.99 & 10.99



save **33-40%**  
 Men's team-licensed outerwear.  
 Reg. 59.99-129.99, sale 35.99-87.09  
 Teants and styles vary by store.

save **35%**  
 Infants'—girls' 4-16 and boys' 4-20  
 selected name-brand & character  
 apparel & access., sale 1.95-25.99  
 EXTRA 10% OFF all toys, sale .38-64.99



save **50%** Entire Stock  
 Holiday decorative home. Decorative  
 pillows, table linens, accent rugs, bath  
 towels & access., more, sale .49-29.99

**REGAL**

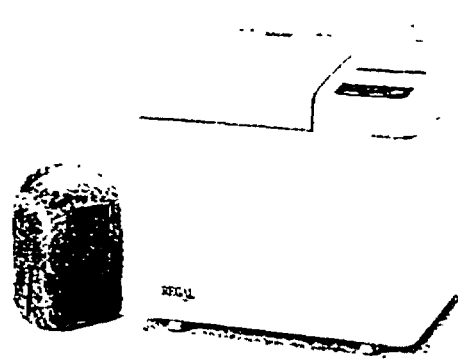

**59.99**  
 50% off a 1½-lb. breadmaker. Six  
 menu selections including rice & jam.  
 Ideal for gluten-free breads. Reg. 129.99

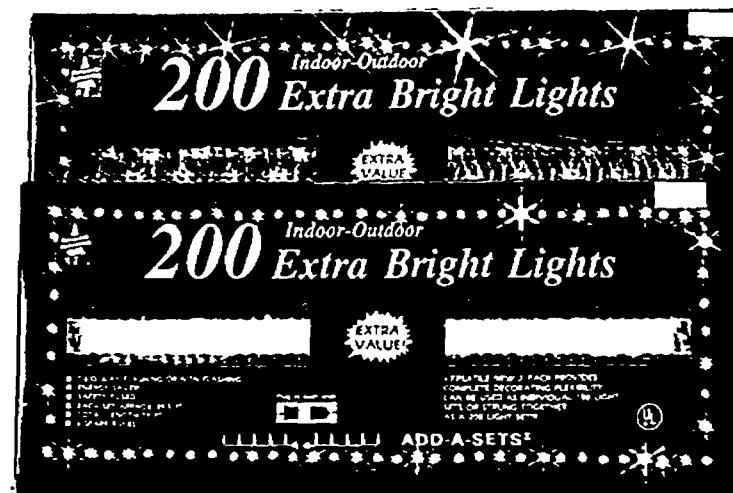

**3.99**  
 ea.

200-ct. Add-a-Set  
 lights. Choose  
 from clear or multi-  
 colored. Reg. 9.99

# FRIDAY ONLY

•Misses'  
•Petites'  
•Plus Size

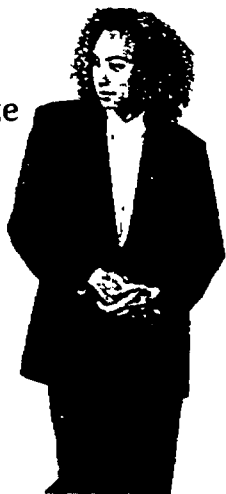

**39.99** Reg. \$68-\$78  
Wool & wool-blend blazers. 40% off misses', petites', plus-size wool separates, 22.80-\$30.00



**save 33%**  
Misses' career blouses. Assorted styles & colors. Reg. \$32-\$42, sale 21.44-\$28.14



**19.99**  
Misses' fleece tops. Reg. \$30  
Appliquéd fleece, sale 27.99  
Plus-size fleece, 23.99-\$30.99



**19.99** Misses' twill  
Sonoma pants. Short, medium and long lengths. Reg. \$28  
Stirrups, 2/\$28, 14.99 ea.



**99.99** Reg. 159.99  
Faux shearling jacket for her. 35% off all other leather outerwear, sale 110.49-\$149.49

60% off All Sterling Silver, Gold-Filled, Vermeil & Black Hills Gold Jewelry, sale 3.99-\$144.00

**179.99** Your Choice  
Save 70% on a 10k gold 1 ct. T.W. diamond tennis bracelet. Reg. \$600 ea.

**BODYSOURCE**

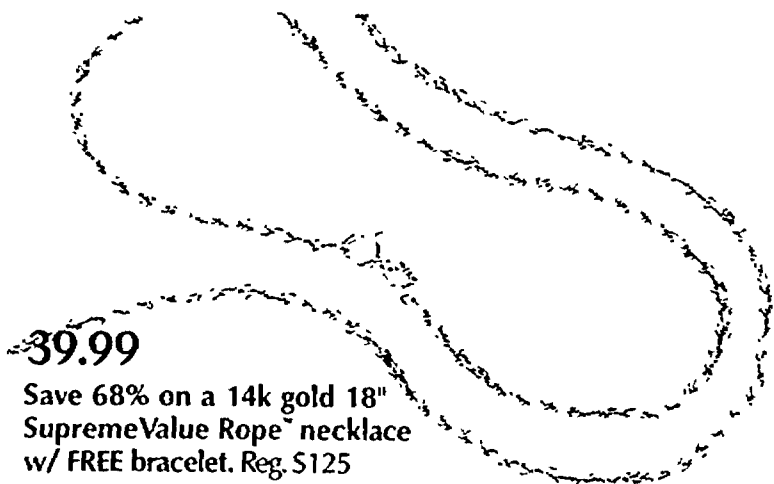

**39.99**  
Save 68% on a 14k gold 18" SupremeValue Rope™ necklace w/ FREE bracelet. Reg. \$125

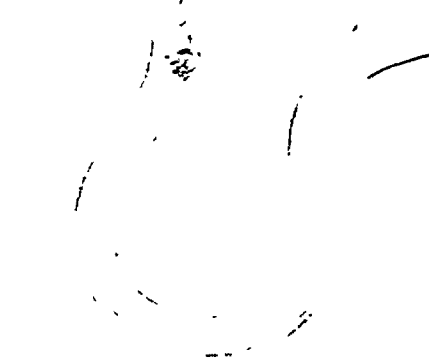

**27.99**  
75% off a 14k gold 18" herringbone necklace with FREE matching bracelet. Reg. \$115

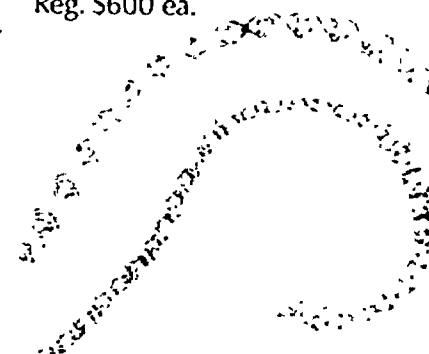

**save 60%** Entire Stock  
Gemstone and diamond jewelry. Reg. \$40-\$1,250, sale \$16-\$500



**save 35%**  
Bodysource™ gift sets. Favorite scents & holiday gifts. Reg. \$6-\$35, sale 3.90-\$22.75

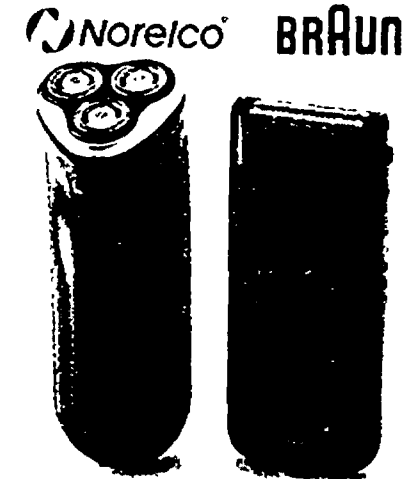

**save 40%**  
Infants' & toddlers' playwear. Quality-made fashions from your favorite makers. Assorted colors and styles. Includes cute holiday looks. Styles vary. Reg. 5.99-\$41.99, sale 3.59-\$25.19



**save 25%** Entire Stock  
Men's & women's shavers. Norelco® and Braun. 24.99-\$129.99, sale 18.74-\$97.49



**save 50%**  
Girls' 4-16 fleece sets and boys' 4-7 fleece sets and separates, sale 7.49-\$14.99



**save 20-30%**  
PLUS, AN EXTRA 10% OFF All toys. Reg. .59-\$99.99, sale .41-\$74.99; less 10%, FINAL PRICE .37-\$67.49

# BONUS BUYS



**SEIKO**  
Someday all watches  
will be made this way.

**TIMEX**  
**PULSAR**  
**CITIZEN**



**9.99** Juniors'  
Flannel shirts. Reg. 14.99  
33% off all other flannel shirts  
& jackets, sale 13.39-20.09

**16.99** Juniors'  
Sonoma denim jeans. Reg. \$24  
Loose Fit Sonoma jeans, 20.99  
Sonoma fleece tops, sale 15.99

**save 40%** Entire  
Stock  
Women's flannel, knit and  
brushed sleepwear, loungewear  
& separates, sale 11.99-28.79

**save 25-30%** PLUS TAKE AN  
EXTRA 10% OFF  
All Seiko®, Timex®, Pulsar® & Citizen watches.  
Reg. 19.95-450.00, sale 13.96-337.50; less 10%,  
FINAL PRICE 12.56-303.75

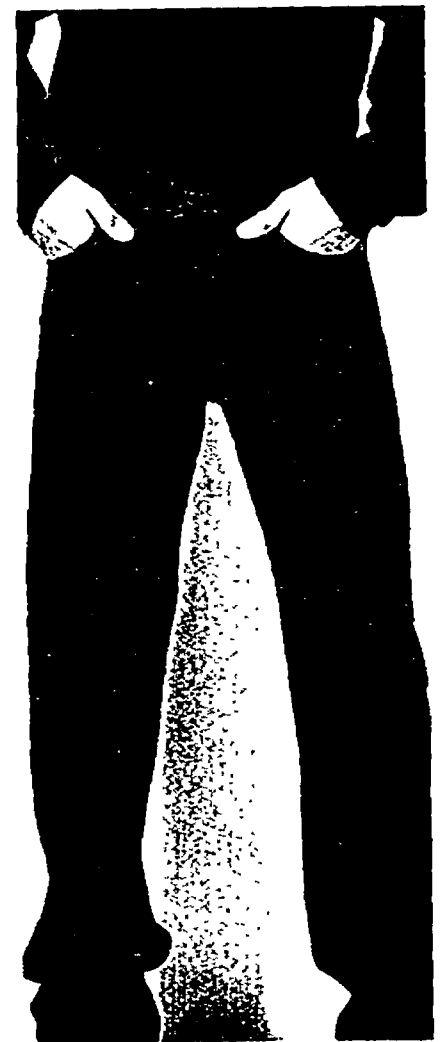
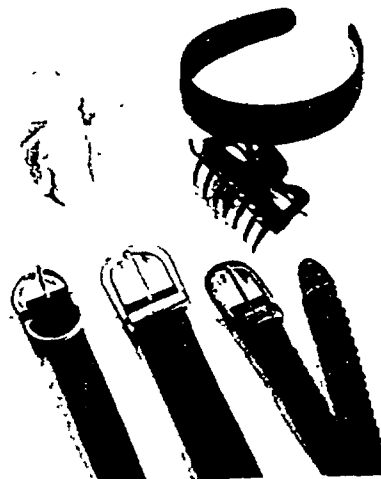

Entire Stock

**save 20-30%**  
Fragrances. All your favorites,  
including designer fragrances.  
Reg. \$4-\$54, sale 2.80-43.20

**save 35%** Entire  
Stock  
Fashion accessories. Hair  
goods, belts, fashion hats and  
more. \$3-\$25, sale 1.95-16.25

**save 33%** Entire  
Stock  
Leather & suede gloves for  
her. Many colors & sizes. Reg.  
\$18-\$38, sale 12.06-25.46

**save 35%** Entire  
Stock  
Packaged bras, 7.80-17.22  
Moments® sheer hosiery.  
Reg. \$2-\$5, sale 1.30-3.25

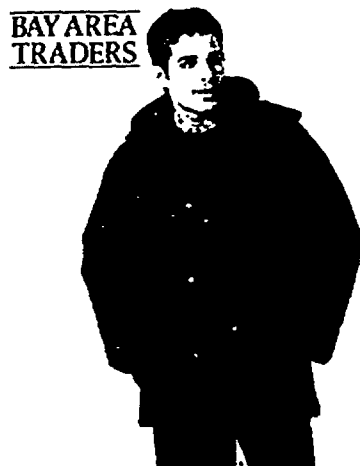
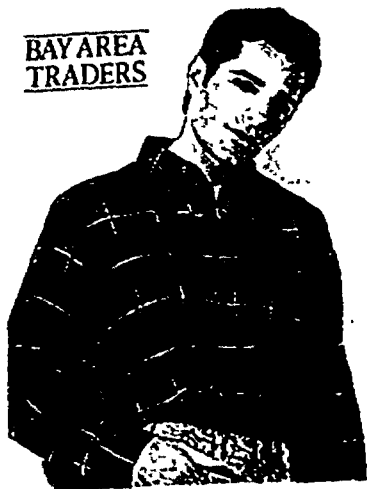

**save 50%**  
Young men's selected  
woven tops. Reg. 19.99-  
24.99, sale 9.99-12.49

**10.99** Men's  
Reg. \$16  
Flannel shirts. 100% cotton.  
Sizes S, M, L, XL, XXL, LT, XLT.  
Men's Croft & Barrow®  
sweaters. Reg. \$34, sale 17.99

**39.99**  
Men's Bay Area Traders®  
parka. Keeps out the cold so  
you stay warm. Reg. \$90

**24.99-27.99**  
Men's Levi's® Signature Series  
jeans. Relaxed & Loose Fits in  
34-44" waist size. Reg. \$38-\$44

**19.99**  
Men's Levi's® 550®, 517® &  
505® Prewashed Indigo jeans.  
Lee® Prewashed jeans, 16.99

**Levi's**

# 33% Off All Sweaters

Men's • Misses' • Plus Size • Juniors' • Kids' Reg. 14.99-90.00, sale 9.99-60.30



GIFT  
CERTIFICATE

\$25

Always the  
perfect gift,  
from \$5-\$100.  
Available at our  
Service Desk.

KOHL'S

**save 33%**

Men's sweaters and sweater vests. Many styles; perfect for gift-giving. Reg. \$30-\$90, sale 20.10-60.30

**save 33%**

Misses' sweaters. Holiday and other designs, sale 20.10-42.88  
Plus-size sweaters. Reg. \$30-\$72, sale 20.10-48.24

**save 33%**

Juniors' cotton sweaters. Warm and comfortable, in all of the latest looks. Reg. 21.99-29.99, sale 14.73-20.09

**save 35-40%**

Toddlers' • Boys' 4-20  
Girls' 4-16 Sweaters

Reg. 14.99-29.99, sale 8.99-17.99 Styles vary.



All Outerwear

**33-40% Off**

Men's • Misses' • Kids'

Reg. 11.99-320.00, sale 7.79-208.00

**save 35%**

Men's outerwear. Reg. \$60-  
\$320, sale 39.00-208.00

**save 33-40%**

Misses' outerwear. Reg. 59.99-  
229.99, sale 40.19-154.09

**save 35%**

Newborns', infants', toddlers',  
boys' 4-20 and girls' 4-16  
outerwear. Reg. 11.99-  
69.99, sale 7.79-45.49

Styles vary



Family Fleece

**30-40% Off**

Men's • Misses' • Jrs.' • Kids'

Reg. 10.99-46.00, sale 7.14-32.20

**save 35%**

Men's fleece. M Sport & C&B Sport by  
Croft & Barrow. \$24-\$40, sale 15.60-26.00

**save 30-40%**

Misses' fleece tops. Reg.  
\$20-\$46, sale 12.00-32.20

**save 30%**

Juniors' screen-printed and  
embroidered fleece tops.  
Reg. \$28-\$36, sale 19.60-25.20

**save 35-40%**

Girls' 4-16 and boys' 4-20  
fleece separates. Reg. 10.99-  
29.99, sale 7.14-19.49

Girls' 4-6x M Sport® basic fleece.  
Reg. 9.99 ea., sale 2/\$12 or 6.99 ea.

Styles vary



Style for a new generation!  
**JUNIORS**

Novelty knit tops.  
 Reg. 19.99-34.99,  
 sale 13.99-24.99

Save 33% on all other  
 knit and woven tops.  
 Reg. 12.99-36.99,  
 sale 8.70-24.78

Wide-leg denim and  
 corduroy jeans. \$29-  
 \$44, sale 21.99-32.99

Arctic fleece & sherpa  
 tops. Reg. \$24-\$34,  
 sale 17.99-24.99

Levi's® denim jeans.  
 Choose from Relaxed,  
 Guy, Loose or Slim Fit.  
 Reg. 39.99, sale 29.99

Other Levi's® denim jeans.  
 Reg. 44.99, sale 32.99

Unionbay® sportswear. Reg.  
 \$22-\$70, sale 15.99-59.99

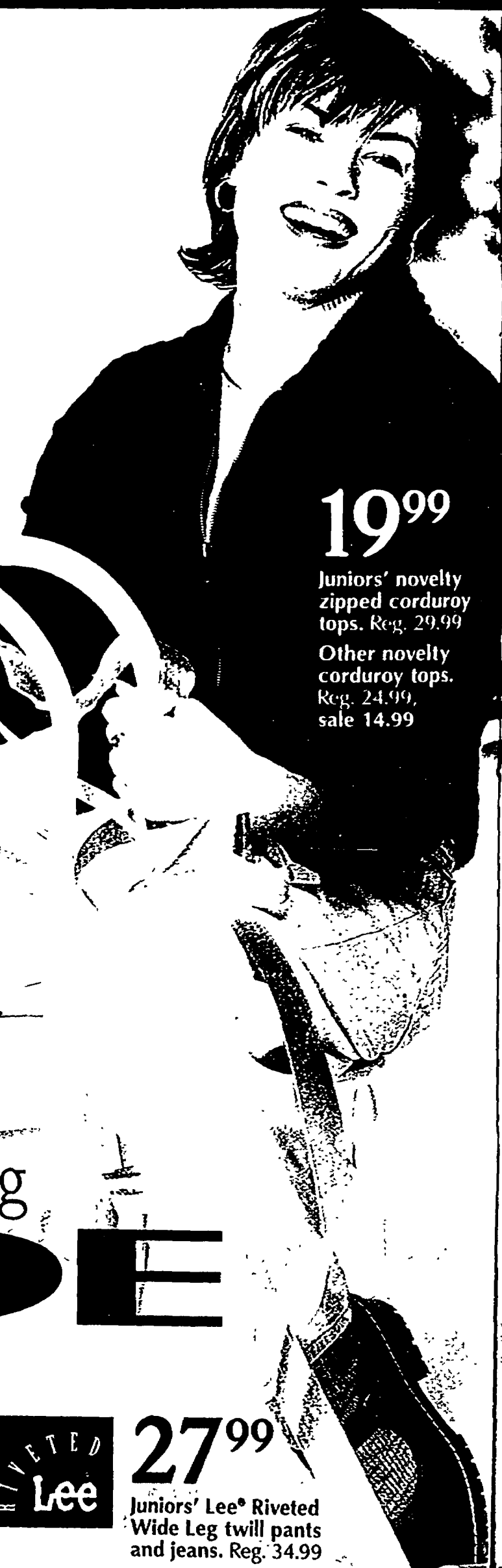
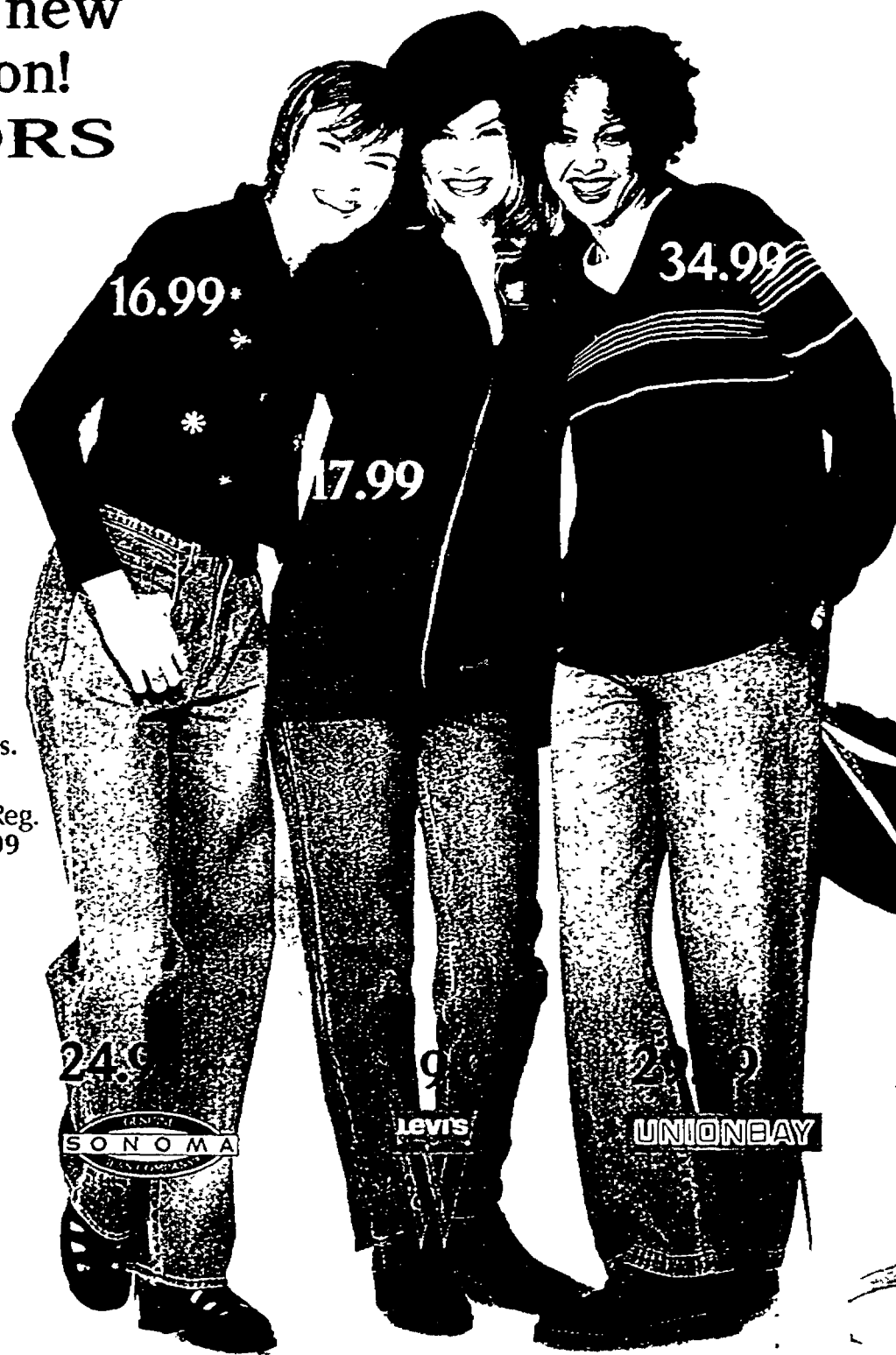

**19<sup>99</sup>**

Juniors' novelty  
 zipped corduroy  
 tops. Reg. 29.99  
 Other novelty  
 corduroy tops.  
 Reg. 24.99,  
 sale 14.99

We're Talking

**WIDE**



**27<sup>99</sup>**

Juniors' Lee® Riveted  
 Wide Leg twill pants  
 and jeans. Reg. 34.99

**2/\$18**

or 9.99 ea.  
Ribbed turtlenecks.  
Reg. 14.99 ea.



**6<sup>99</sup>**

Basic leggings by  
No Restrictions  
Reg. 9.99

40% off fashion  
knit pants, sale  
9.00-17.99



**19<sup>99</sup>**

Twill pants.  
From Kikomo and  
Chazz. Reg. 26.99

Other juniors'  
twill pants:  
Reg. 29.99-39.99,  
sale 24.99-32.99

**Kikomo**



**33% Off**

Entire stock  
novelty sweaters.  
Includes chenille, fur-  
blends, boucle & more.  
24.99-49.99, sale  
16.74-33.49



# IT'S A Junior THING

**23<sup>99</sup>**

Lee® jeans.  
Relaxed and  
Boy Fits.  
Reg. 29.99



**24<sup>99</sup>**

Denim overalls,  
Reg. \$34

Other denim  
and corduroy  
overalls. Reg.  
\$34-\$46, sale  
24.99-34.99

**SQUEEZE**



**14<sup>99</sup>**

Palmetto's® thermal  
tee. Reg. \$20

**22<sup>99</sup>**

Palmetto's® corduroy  
jeans. Reg. \$32.  
Other Palmetto's®  
sportswear. Reg.  
\$16-\$44, sale  
10.99-31.99

**PALMETTO'S**



**19<sup>99</sup>**

Sonoma  
corduroy  
shirt. Reg. \$30

**SONOMA**  
GENUINE  
HAT COMPANY



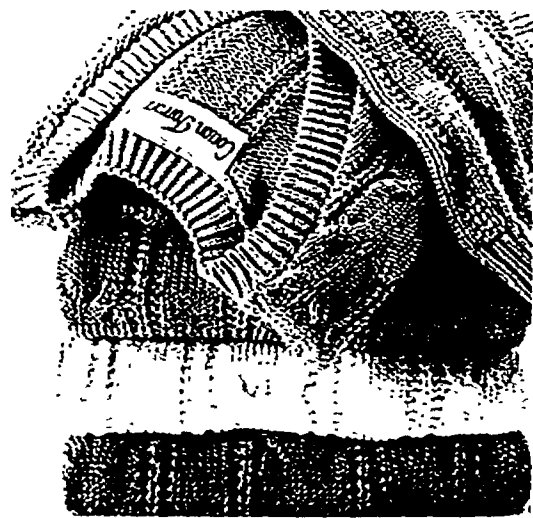

**24<sup>99</sup>** Misses'

Rayon-blend cable sweaters. Reg. \$38  
Other corporate casual separates  
and career blouses, sale 14.99-34.99



**2/\$19** or 9.99 ea.

Misses', petites' and plus-size solid-  
color turtlenecks. Reg. \$14 ea.  
Misses' & petites' print & embroidered  
turtlenecks, sale 2/\$21 or 10.99 ea.  
Plus sizes, sale 2/\$25 or 12.99 ea.

## **More** on Sale

- SALE 12.99-24.99 Misses' Lee<sup>®</sup>  
knit and woven tops. Reg. \$19-\$36
- SAVE 20-30% on misses' casual  
pants. Reg. \$22-\$38, sale 14.99-29.99
- SALE 2/\$34 or 17.99 ea. M Sport<sup>®</sup>  
fleece separates for her. Reg. 21.99 ea.
- SAVE 25-30% on fitness wear for  
her. Reg. 9.99-85.00, sale 6.99-59.50
- SAVE 30-35% on petites' casual  
sweaters & knit tops, sale 15.99-29.99
- SAVE 25-33% on petites' career  
pants & stirrups, sale 14.74-21.99
- SAVE 25-33% on plus-size knit, woven  
and fleece tops, sale 9.99-36.99
- SAVE 30% on plus-size casual  
sportswear, sale 12.59-33.60
- SAVE 25-30% on maternity sports-  
wear and basics, sale 2.47-44.80

# 24<sup>99</sup>

## Your Choice Sweaters or Pants

Misses' sweaters & knit pants.  
A gift she'll love to wear. Reg. \$38 ea.  
33% off other Katherine Marie  
coordinates, sale 22.78-56.28  
33% off other misses', petites'  
& plus-size selected coordinates.  
Reg. \$24-\$66, sale 16.08-44.22

## KATHERINE MARIE

**28<sup>99</sup>**

Save 33% on a  
misses' cardigan.  
Reg. \$44



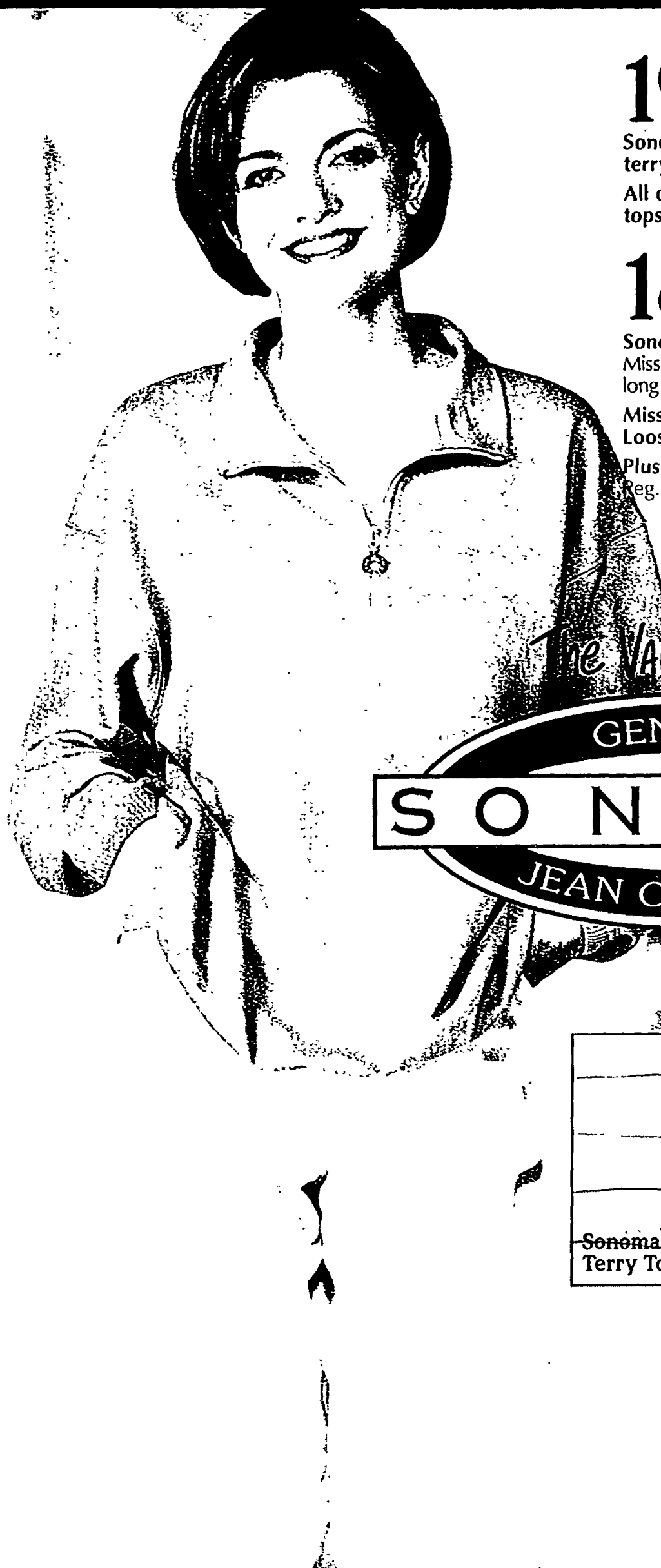

**19<sup>99</sup>** Misses'

Sonoma garment-dyed French terry top. Reg. \$30

All other misses' Sonoma tops, sale 12.99-28.99

**18<sup>99</sup>** Misses' & Petites

Sonoma Relaxed Fit jeans. Misses' in short, medium and long lengths. Reg. \$24

Misses' & petites' Sonoma Loose Fit jeans, sale 20.99

Plus-size Sonoma jeans. Reg. \$28, sale 20.99

*The Value Fits*

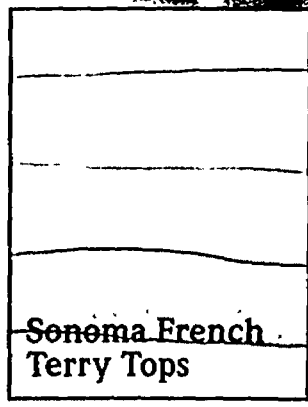

Sonoma French Terry Tops

**GIFT CERTIFICATE**  
**\$25**  
 Always the perfect gift, from \$5-\$100. Available at our Service Desk.  
**KOHL'S**



**23<sup>99</sup>** Misses' & Petites'

Lee® Relaxed Fit jeans. Misses' in medium and long lengths. Reg. 29.99  
 Plus-size Lee® jeans. 32.99, sale 25.99  
 Other misses', petites' and plus-size Lee® sportswear also on sale!

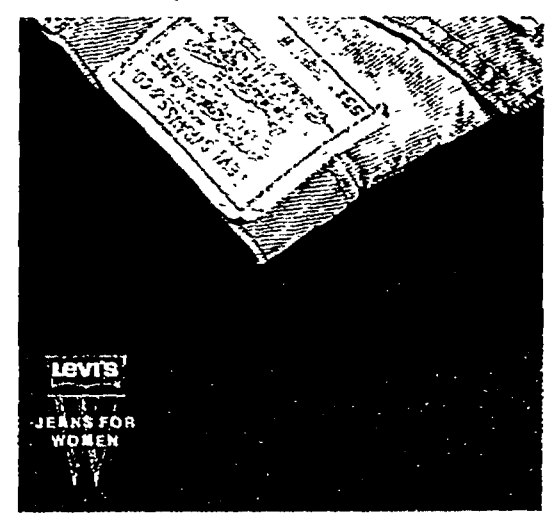

**29<sup>99</sup>** Misses' & Petites'

Levi's® denim jeans. A great basic. Other misses' Levi's® jeans, sale 34.99  
 Plus-size Levi's® jeans, sale 36.99



**26<sup>99</sup>** Misses'

Levi's® Dockers® khakis for women. Flat-Front, Classic and Relaxed Fits. In short, medium and long lengths. Reg. \$36

# 40% Off Entire Stock Social Dresses

## Our Best Prices on Juniors' & Misses' Holiday Dresses

Reg. 49.99-99.99, sale 29.99-59.99

30% off all other juniors', misses', petites' and plus-size dresses. Reg. 39.99-99.99, sale 27.99-69.99



Gift Certificate

\$25

**KOHL'S**

Always the perfect gift, from \$5-\$100. Available at our Service Desk.

# Great Gift Ideas! 6<sup>99</sup> ea.

Miniature designer fragrances. Reg. 9.99 ea.  
15% off other designer fragrances. 17.00-45.90



6<sup>99</sup>

Bodysource™ gift sets. Reg. \$10  
30% off other bath & body, sale .70-24.50



Exclusively at Kohl's



9<sup>99</sup>

Fragrance gift sets. Reg. 11.95-14.95  
20% off other fragrances, sale 3.20-28.80 Excludes designer fragrances.



Hair accessory gift sets. Includes hair twister, hair clip and nail polish. Reg. 9.99  
30% off other fashion accessories, 2.10-17.50

9<sup>99</sup>-14<sup>99</sup>

50% off teardrop & stardust bottles. Reg. \$20-\$30  
Styles vary by store.

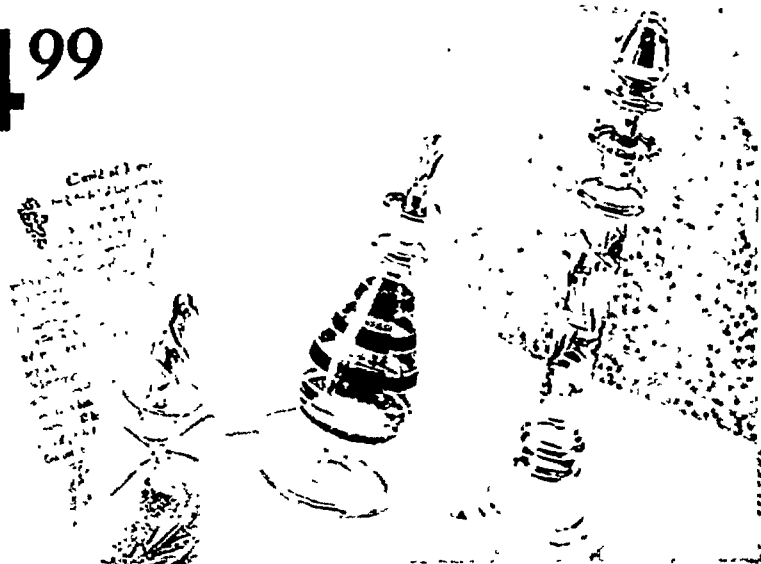

1<sup>99</sup>

Classic Moments® potpourri. Reg. 4.99  
30-50% off other home fragrances, sale 1.75-21.00  
Excludes Chire Birke.



6<sup>99</sup>

Your Choice

Nature's Spa comfort wrap or sinus wrap. Reg. \$10 ea.  
30% off other comfort & massage items, 2.80-14.00

1928.



**8<sup>99</sup>** Selected minibags. Reg. \$15  
33% off all other purse accessories.  
Reg. \$2-\$34, sale 1.34-22.78

**30% Off** 1928<sup>®</sup> jewelry, sale 4.90-42.00  
33% off Croft & Barrow<sup>®</sup> jewelry, sale 5.02-30.15

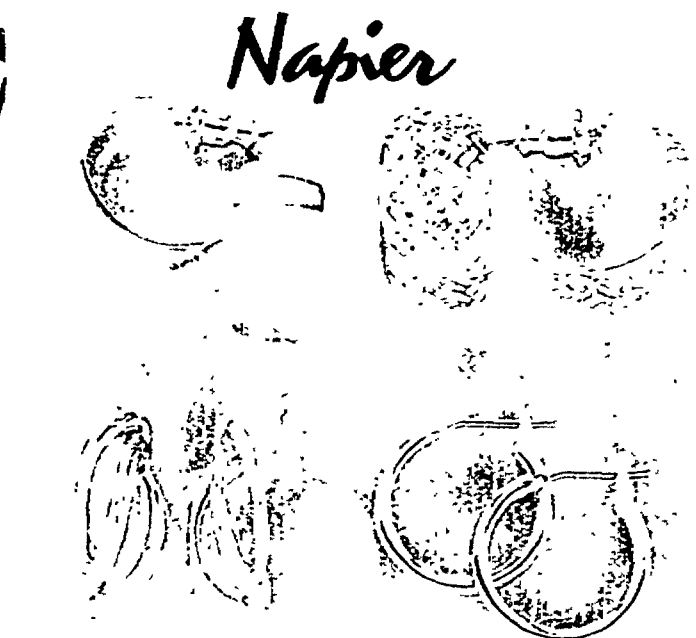
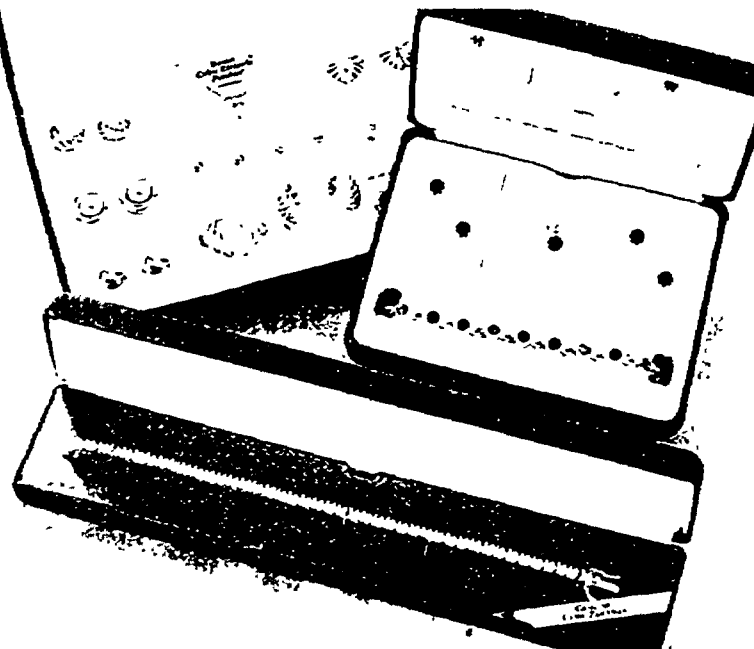

*Napier*

**33% Off** Entire Stock Boxed jewelry, sale 5.35-16.74  
Tailored jewelry, sale 2.67-16.74  
Cubic zirconia and fashion gemstone rings, sale 6.69  
Styles vary. Excludes famous makers.

**25% Off** Napier<sup>™</sup> earrings.  
Reg. 7.50-35.00,  
sale 5.62-26.25

**14<sup>99</sup>** Your Choice

Vinyl handbags or leather purse accessories. Reg. 19.99-25.00  
35% off all other handbags, sale 5.19-44.85

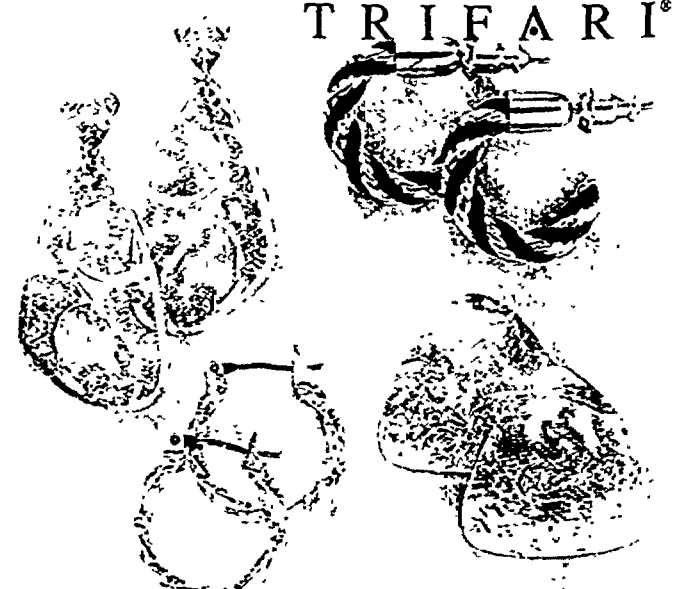
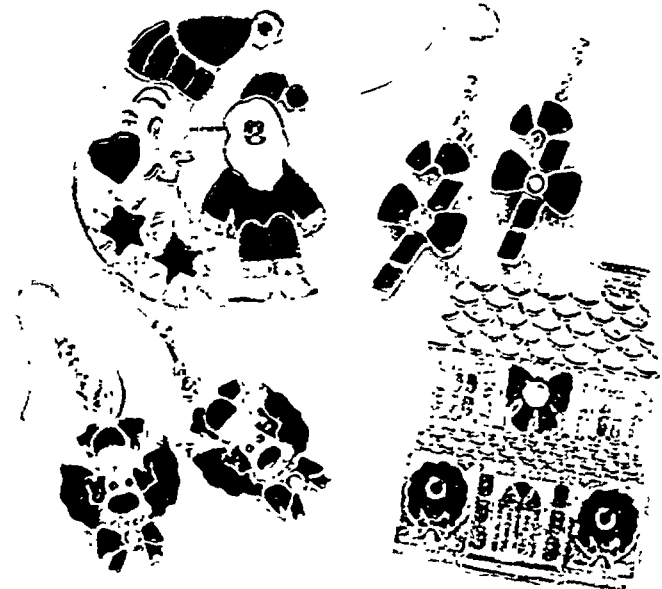

TRIFARI<sup>®</sup>

**33% Off** Holiday jewelry, sale 3.34-18.42  
Color and trend fashion jewelry, sale 2.67-16.74  
Styles vary. Excludes famous makers.

**25% Off** Trifari<sup>®</sup> earrings, 4.50-26.25  
Marvella<sup>®</sup> necklaces. Reg. \$10-\$65, sale 7.50-48.75

# Save 50-60% on All Fine Jewelry

Reg. 24.99-1,250.00 sale 9.99-500.00

**99<sup>99</sup>**

60% off a 14k gold 20" rope necklace with FREE bracelet. Reg. \$250

**49<sup>99</sup>**

66% off a 14k gold 18" hollow rope necklace. Reg. \$150

## Save 25-50% on All Watches

Reg. 13.99-450.00, sale 10.49-337.50

**9<sup>99</sup>**

50% off Christmas watches. Reg. 19.99 Musical Christmas watch, sale 14.99

**14<sup>99</sup>**

or 2/24.99  
40% off fashion watches. In a variety of popular styles. Reg. \$25 ea.

## Save 50-55% on All Sterling Silver, Gold-Filled, Vermeil & Black Hills Gold™ Jewelry

Reg. 9.99-360.00, sale 4.99-180.00



**3/19<sup>99</sup>**

or 7.50 ea.  
Sterling silver rings. Reg. \$15 ea.

**8<sup>99</sup>**

or 2/15.99  
Sterling silver and vermeil boxed jewelry. Reg. 19.99 ea.

**29<sup>99</sup>**

or 2/49.99

Save 62% on 14k gold earrings. Hoops, leverbacks and other styles. Reg. \$80 pr.



24<sup>99</sup>

Arctic fleece, fleece and brushed terry robes. Fashion colors. Reg. 29.99-39.99



Entire Stock  
15<sup>99</sup>

Satin sleepwear. Chemises and ballet gowns. Reg. 21.99-29.99



12<sup>99</sup>

Flannel sleepshirts. Plaids vary. Reg. 19.99-21.99



13<sup>99</sup>

Fashion daywear. Reg. 19.99-24.99  
30% off all other daywear, sale 7.70-20.30



14<sup>99</sup>

Full-figure bras. From Olga®, Bali®, Playtex® and more. Reg. 18.50-27.00



Buy any 2 Olga® bras & get 1 FREE by mail!

Entire Stock  
33% Off

Selected panties. Reg. 3/10.50 to 9.00 ea., sale 7.03 to 6.03 ea. Excludes Jockey For Her.



30% Off

Hanes Too!®, Hanes Too!® Plus and Profiles® sheer hosiery. Reg. 2.95-7.50, sale 2.06-5.25  
25% off Resilience Plus®, sale 5.21

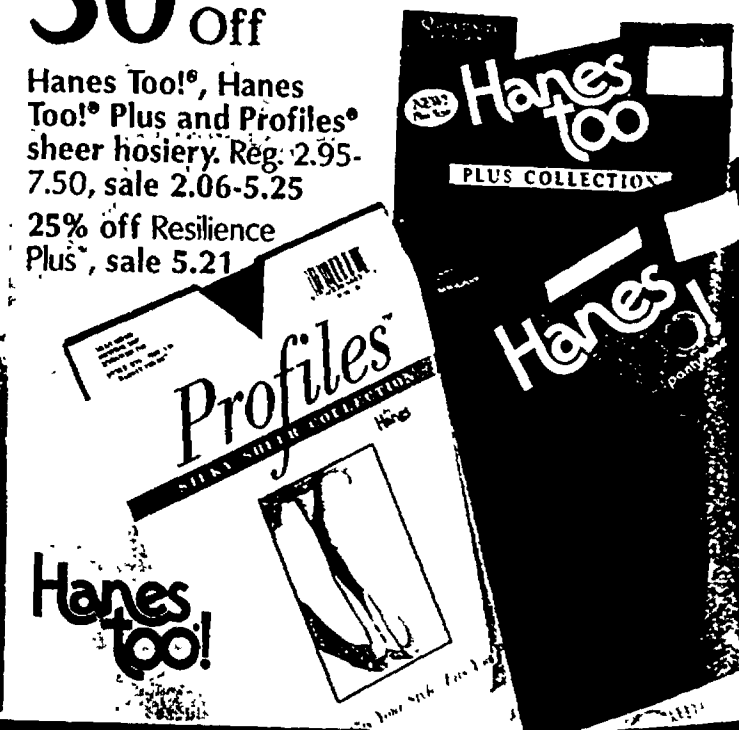

SAVE 33% on All Other Sleepwear, Robes, Dusters, Loungewear and Daywear

**25% Off**

Boxed Isotoner® Classics gloves. Reg. \$21-\$34, sale 15.75-25.50



ISOTONER



**11.99** Women's

Bay Area Traders® ski gloves. Reg. 15.99-17.99. Save 30% on other ski gloves and cold-weather knitwear, sale 1.75-26.60

**33% Off**

Family slippers and warm-up boots. For men, women and kids. Reg. 9.99-38.00, sale 6.69-25.46. Excludes Isotoner.

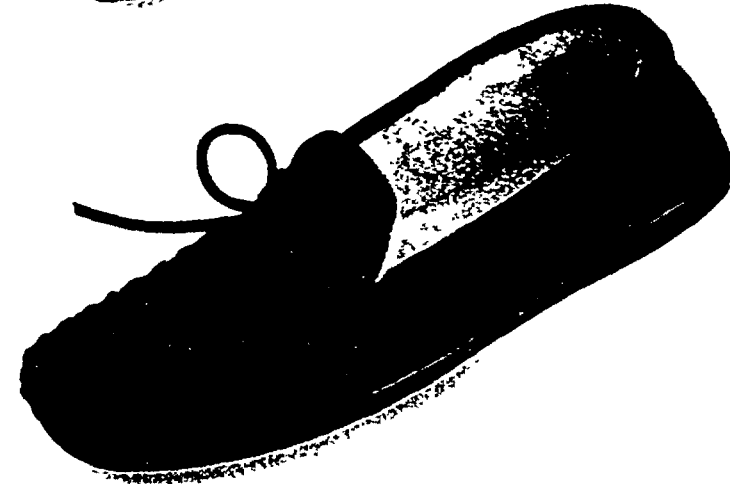

**25% Off**

Selected Microcore™ products. Seat cushion, heart & hand warmer or slipper socks. Reg. \$10-\$30, sale 7.50-22.50



**25% Off**

Isotoner® slippers. Reg. \$16-\$22, sale 12.00-16.50

ISOTONER



**2/\$7** or 3.85 pk.

Moments® casual 3-pair pack anklets. Reg. 5.50 pk. 30% off all other women's anklets and tights, sale 1.74-5.59



MOMENTS

**9.99**

Hoodwrap by Totes®. Classic colors. Reg. \$14. 30% off other boxed knitwear & earmuffs, sale 2.79-15.39

totes.

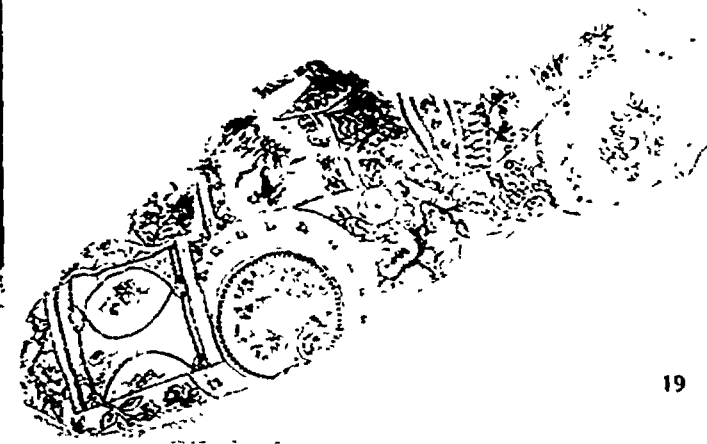

19<sup>99</sup>

Men's Lee®  
Regular &  
Relaxed Fit  
denim jeans.  
Lee® Riveted®  
jeans, 24.99

Lee



Levi's

24<sup>99</sup>

Men's Levi's® 550™ Relaxed Fit  
denim jeans. Choose from all the  
most popular finishes.  
All other men's Levi's® denim  
jeans, sale 26.99-34.99  
All men's Levi's® denim jackets.  
45.00-96.99, sale 33.75-77.59  
Young men's woven tops.  
\$28-\$32, sale 18.76-21.44

# 30% Off

Men's name-brand sport shirts and sweaters. Reg. \$20-\$58, sale 14.00-40.60  
Save \$8-\$12 on Natural Issue® sport shirts and vests. Reg. \$32-\$38, sale 21.99-27.99

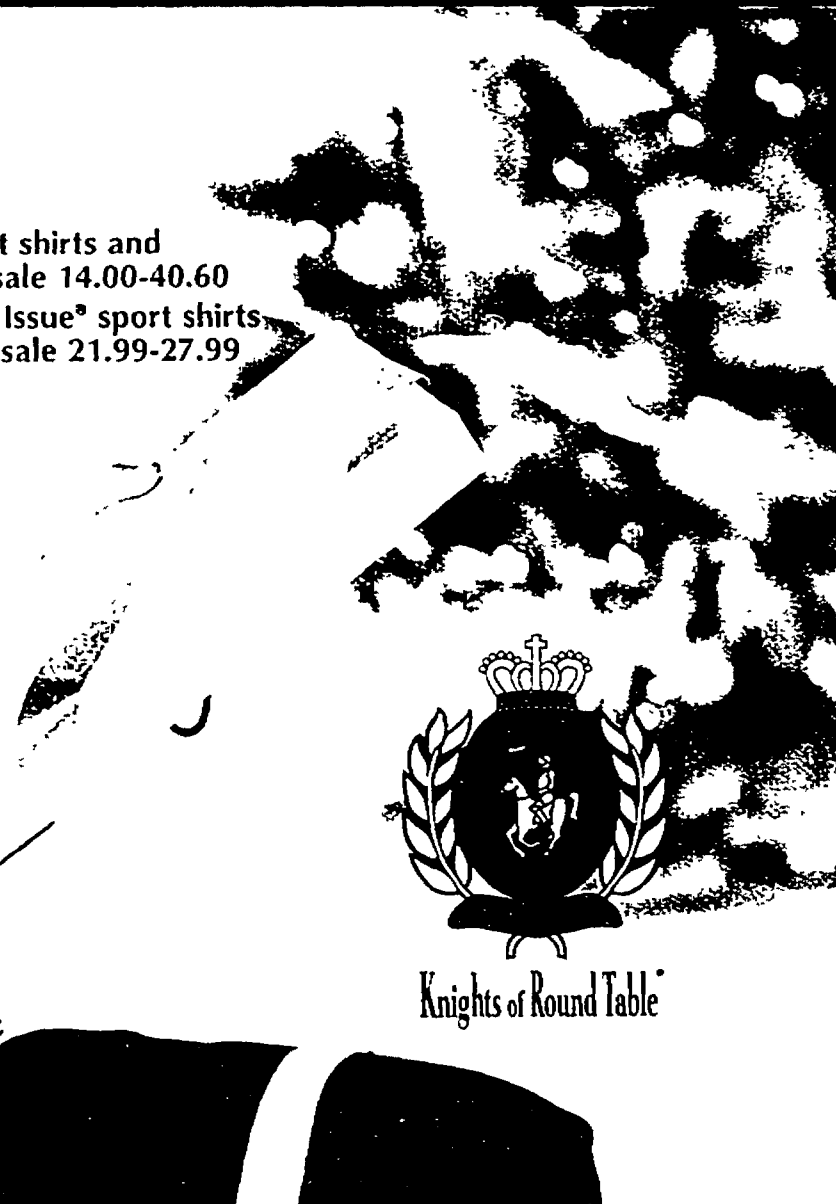

Knights of Round Table®

# 33% Off

Men's name-brand activewear. Reg. \$30-\$60, sale 20.10-40.20

CROFT & BARROW.

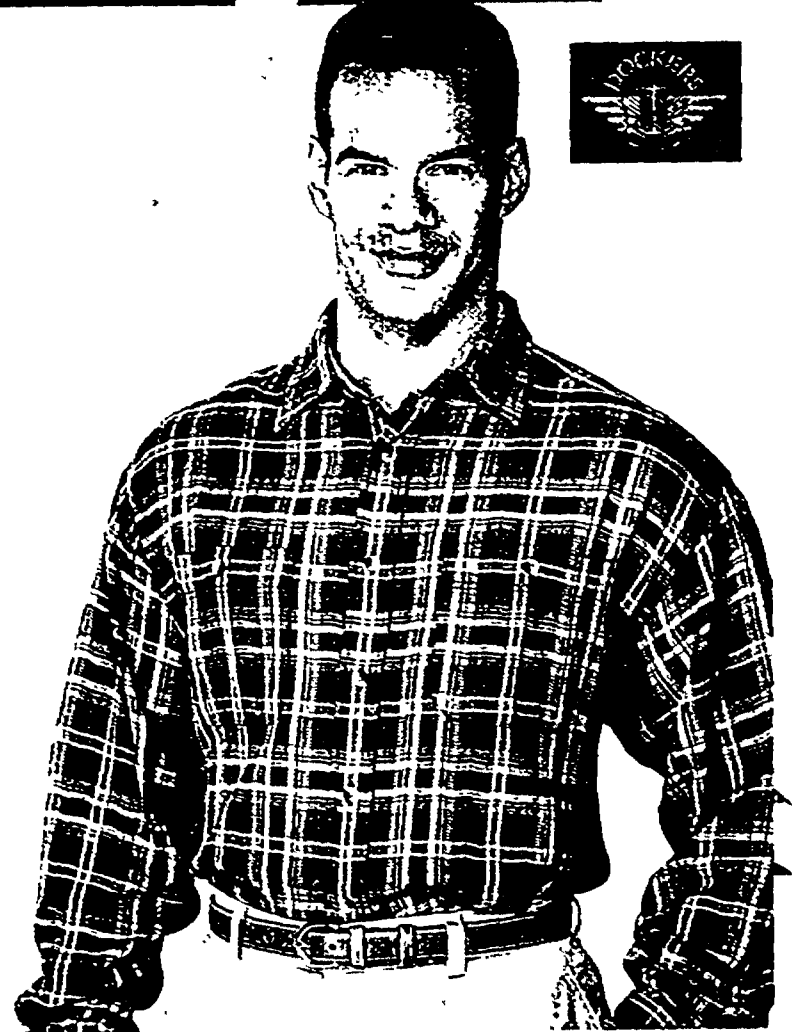

# 30% Off

Croft & Barrow® woven sport shirts. Extended sizes S, M, L, XL, XXL, LT, XLT. Reg. \$28-\$32, sale 19.60-22.40

# 25% Off

All Dockers® sport shirts and shorts, sale \$24-\$36  
\$9-\$11 off all men's Dockers® pants, sale 24.99-39.99

# 16<sup>99</sup>

Men's Croft & Barrow® denim dress shirts. Extended sizes to 18½" neck. Reg. 27.99

Haggar® Wrinkle-Free classic pleated pants, sale 29.99

All Other Croft & Barrow®, Haggar® & Requirements Dress Shirts

Reg. \$14-\$36, sale 9.99-24.99

All Neckwear sale 7.99-16.99

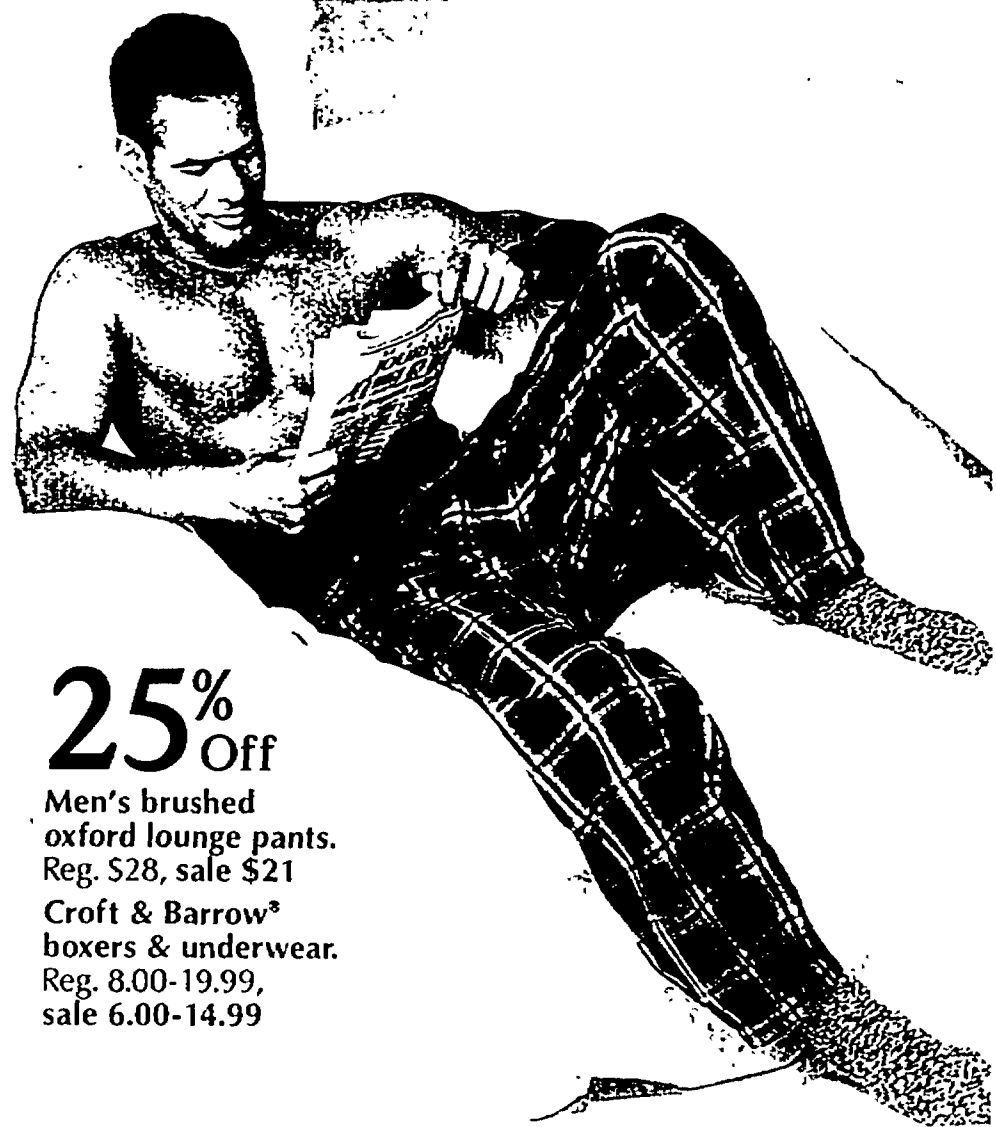

## 25% Off

Men's brushed oxford lounge pants. Reg. \$28, sale \$21

Croft & Barrow® boxers & underwear. Reg. 8.00-19.99, sale 6.00-14.99

## MORE Sale for Men

- SALE 36.99-39.99 Entire stock Haggar® Wrinkle-Free cotton pants. Reg. \$45-\$48
- SALE 26.99-39.99 Other Haggar® and Levi's® dress pants. Reg. \$34-\$50
- SAVE 25% on Haggar® belts & wallets, sale 15.00-18.75
- SAVE 25% on Aris® Isotoner® gloves, sale 13.49-26.24
- SAVE 25% on Requirements hosiery, sale 2.24-3.74

**HAGGAR**  
Stuff you can wear.



## 25% Off

Men's Champion® underwear. Lo-rise briefs, button-fly boxers, tanks and more. Reg. 5.50-18.00, sale 4.12-13.50



## 25% Off

Hanes® Red Label 3-pack underwear, sale 4.49-9.74  
3-pk. briefs, 2/\$8 or 4.29 ea.  
2X briefs 3-pk., sale 7.49



# 25-50% Off

## Team-Licensed and Name-Brand Athletic Apparel and Outerwear

Adults and boys' 8-20.  
Reg. 14.99-129.99, sale 10.49-90.99  
Teams & styles vary by store.

25% off adults' & boys' 8-20 Champion® apparel. Fleece or jerseys. ADULTS' IN REGULAR & EXTENDED SIZES, sale 11.99-67.49

Adults' Starter® 9-oz. fleece crews or pants. Reg. 29.99 ea., sale 21.99 ea.

Adults' Adidas® Burdett jacket. Reg. 84.99, sale 54.99



# Entire Stock 40-50% Off

Luggage. Totes, duffels, wheeled carry-ons and more. Reg. 29.99-399.99, sale 17.99-239.99  
30-50% off all business cases & totes, 5.59-66.99  
20-30% off all team-licensed and name-brand sport bags and daypacks, sale 13.99-49.99



# 33-40% Off

Team-licensed accessories. Balls, ornaments, more. Teams & styles vary. Reg. 4.99-39.99, sale 2.99-26.79

# 40% Off Kids' Holiday Dress-Up

Infants' • Toddlers' • Girls' 4-16  
Velvets, shimmery fabrics and  
other festive holiday styles. Reg.  
11.99-47.99, sale 7.19-28.79

35% off boys' 4-7 selected  
name-brand apparel. 11.99-  
34.99, sale 7.79-22.74



save 30-35%

Girls' dressy accessories.  
Reg. 2.29-12.99, sale 1.49-9.09

Infants' & Toddlers'  
Holiday Dress-Up



GIFT  
CERTIFICATE

\$25

Always the  
perfect gift,  
from \$5-\$100.  
Available at our  
Service Desk.

KOHL'S

12<sup>99</sup>

Girls' 7-16 Sonoma jeans. Reg. \$19.99

Boys' 8-14 Sonoma Relaxed & Loose Fit jeans. \$18 sale-13.99

15<sup>99</sup>

Lee

Boys' 8-14 and girls' 7-16 Lee jeans. Reg. 24.99 sale 15.99

16<sup>99</sup>

Levi's

Boys' 8-14 Levi's 50" & girls' 7-16 550" & 512" jeans. Reg. 26.99 & 20.99

16<sup>99</sup>

Boys' 8-20 retro top. Reg. 24.99

Other knit and woven tops. Reg. 16.99-26.99, sale 11.04-18.99



30-40% Off

Girls' Sleepwear

Reg. 13.99-28.99, sale 8.39-17.39



save 40%

Infants' and toddlers' sleepwear and blanket sleepers. Styles vary, sale 4.19-13.19

save 40%

Newborns' playwear. 14.99-29.99, sale 8.99-17.99\*

35% off infants' 100% cotton playwear, sale 7.79-12.99\*



30% off infants' and toddlers' Mickey & Co. sleepwear and blanket sleepers, sale 9.09-11.89

\*Playwear not intended as sleepwear

MORE on Sale

•SALE 18.99 Boys' 8-20 Unionbay® jeans. Reg. 26.99  
•SAVE 25% on boys' 8-20 Dockers® casual pants and knit & woven tops, 21.00-24.75

•SAVE 35% on boys' 8-20 Bugle Boy® and Izod® casual twill pants, sale 11.04-17.54  
•SALE 12.99-17.99 Boys' 4-7 denim. Reg. 17.00-27.99

•SALE 9.99-21.99 Girls' 4-6x denim. Reg. 14.00-27.99  
•SAVE 30-35% on infants' & girls' accessories. Reg. .89-59.99, sale .57-38.99

•SAVE 33% on infants' sleep 'n' plays and layette. Reg. 9.99-23.99, sale 6.69-16.07



# 20% Off

LEGO® building sets and accessories. Reg. 1.49-99.99, sale 1.19-79.99  
Selection varies by store



Gift Certificate  
\$25  
Always the perfect gift, from \$5-\$100. Available at our Service Desk.  
KOHLS

# 30% Off

Little Tikes® toys. Safe and fun for infants and pre-schoolers. Reg. 4.99-59.99, sale 3.49-41.99  
Selection varies by store.



# 25% Off

Barbie®. Dolls, fashions, playsets and more. Reg. 1.69-99.99, sale 1.26-74.99  
Selection varies by store.

# Barbie



# 30% Off All Other Toys

Selection varies by store. Reg. .59-99.99, sale .41-69.99



# 33-50% Off Entire Stock

Games, banks and puzzles. 3-D and mystery puzzles, banks, Word Spin, Stir Crazy and more. Reg. 4.99-49.99, sale 3.34-33.49  
40-60% off all other stationery gifts. Reg. 1.59-74.99, sale .64-44.99



Entire Stock  
save 40-50%

Photo albums, sale 1.79-13.19  
Metal minis. Reg. 12.99, sale 7.99  
100-pg. magnetic albums, 5.49-7.99



sale 8.99

Gift sets. Reg. 14.99-16.99  
Photo box. Reg. 7.99, sale 3.49  
Wedding & baby albums, 2.00-23.45



save 33% Entire Stock

1997 calendars. Choose from wall and mini calendars and more. Reg. 2.99-23.99, sale 2.00-16.07



save 40% Entire Stock

Framed art. Many print styles, including florals, vegetables, angels and more. Reg. 12.99-159.99, sale 7.79-95.99



save 33%

Basic candles, tapers, pillars, jars & more. .79-29.99, sale .53-20.99

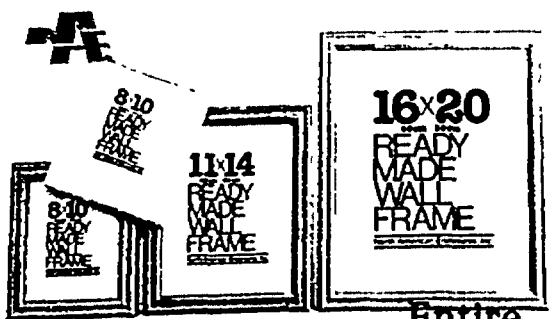

save 40-50% Entire Stock

NAE wall and poster frames. Reg. 11.99-37.99, sale 7.19-22.79

# 40% Off Entire Stock Entertainment Centers

Many styles and sizes to coordinate with any home's decor. Reg. 159.99-369.99, sale 95.99-221.99

149.99

Entertainment center shown.  
•Holds most 27" TVs  
•Full-length door for storage  
•Adjustable shelves

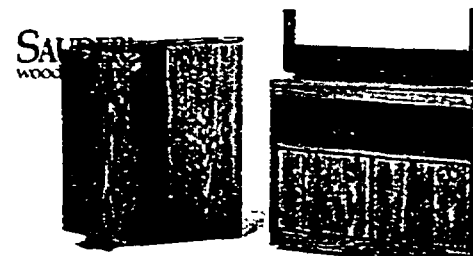

SAUDER  
WOOD  
Your Choice  
sale 39.99  
Sauder® tape storage cabinet or TV/VCR cart with swivel top. Reg. 69.99 ea.

79.99

Computer workcenter. Pull-out keyboard, side storage. Reg. 149.99

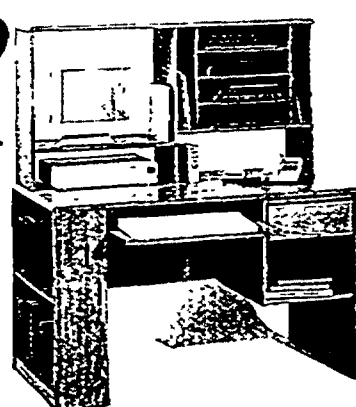

Lowest price ever!



sale 9.99

Hugger lamp. Gift-boxed. Reg. 29.99



sale 59.99

5-pc. bridge set. Includes 34" square table and four folding chairs. Also available in taupe or navy. Reg. 119.99



sale 11.99

Decorative flags. Reg. 14.99  
30% off all other flags & accessories. Reg. 8.99-24.99, sale 6.29-17.49



sale 29.99 Your Choice

Rocking horse or chair. Reg. 44.99 ea. 33% off all other Kids At Play furniture, sale 9.99-69.99

**WAECHTERSBACH**

**save 33%** Entire Stock

Waechtersbach dinnerware & accessories. Perfect for holiday entertaining. sale 3.34-32.15

**STUDIO NOVA**

**save 50%** Entire Stock

Studio Nova holiday glass gifts. Candy dishes, serving platters, more. 9.99-24.99, sale 4.99-12.49

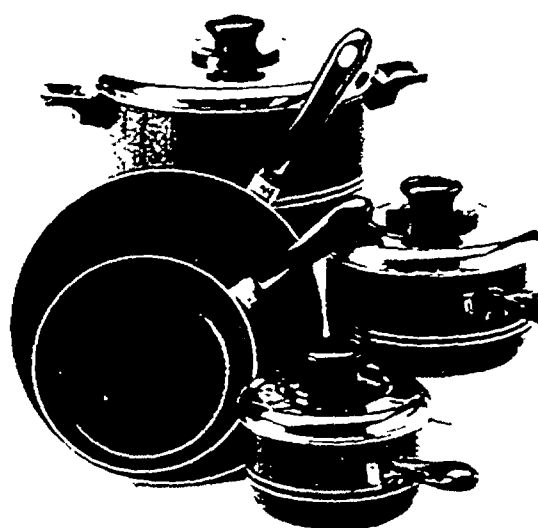
**T-FAL**

**sale 49<sup>99</sup>**

T-Fal<sup>®</sup> Classic 8-pc. cookware set. Non-stick, textured interiors. Vented lids. Reg. 89.99

**T-FAL****MEYER**

**sale 16<sup>99</sup>** Your Choice

T-Fal<sup>®</sup> or Meyer<sup>™</sup> 3-piece fry pan set. Both have non-stick interiors for healthy cooking. Reg. 27.99 set



**sale 39.99** Reg 69.99

Windsor chair. Natural or oak-stain. 25-40% off all other country wood furniture, sale 29.99-269.99

**CORNINGWARE**

**24.99** After \$10 rebate

French White<sup>®</sup> 9-pc. serving set with cradles. Reg. 59.99, sale 34.99  
NFL portables. Reg. 44.99, sale 22.99

**CORNINGWARE**

**8.49** with BONUS

French White<sup>®</sup> 1½-qt. round or oval casserole w/FREE mini-storage. Reg. 21.99  
4-qt. French White<sup>®</sup> casserole, sale 9.99



**sale 44.99**

Revere Ware<sup>®</sup> 7-pc. stainless-steel cookware set. Choose copper-clad or aluminum-disc bottoms. Reg. 89.99

**WINSOME WOOD**

**9.99**

Oak-stain flip-top bed tray. Perfect for reading or snacking in bed. Reg. 16.99

**Cushion Aire**

**8.99** with BONUS

Cushion Aire<sup>®</sup> insulated 14x16" cookie sheet. Two cookie cutters & sprinkles FREE w/purchase! Reg. 19.99

**FARBERWARE**

**save 40%** Entire Stock

Kitchen gadgets and cutting boards. Measuring spoons, spatulas & more. 1.49-24.99, sale .89-14.99

**sale 57.99**

Thermoscan<sup>®</sup> thermometer. Reg. 69.99

10-50% off entire stock personal care. Reg. 2.19-299.99, sale 1.97-269.99

**BRAUN****BRAUN**

**sale 39<sup>99</sup>**

5-piece beech TV tray set. Includes 4 snack trays and stand. Holiday favorites! Reg. 89.99

**sale 39.99**

Spacemaker<sup>®</sup> radio with cassette tape player. Reg. 54.99  
35% off all table & wall clocks. Reg. 9.99-599.99, sale 6.49-389.99

**sale 14.99**

GE clock radio. Reg. 19.99  
20% off all other clock radios and Spacemakers<sup>®</sup>, sale 10.39-143.99

**Proctor Silex**

**KitchenAid**

**BLACK & DECKER**

**WORLD VAC**

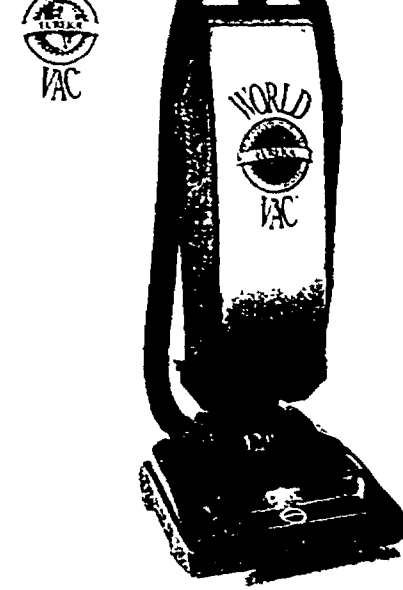
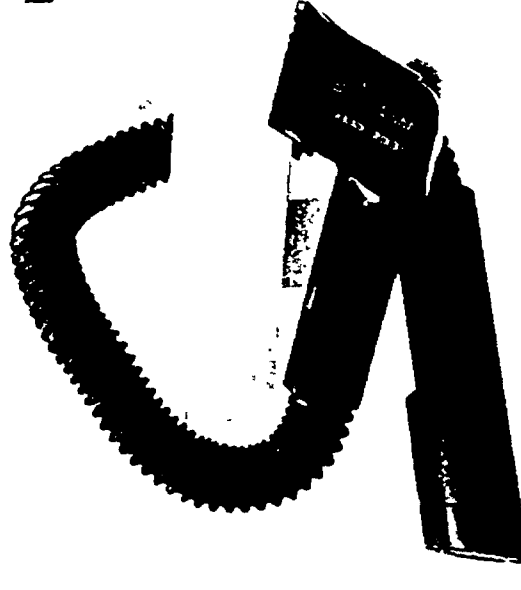
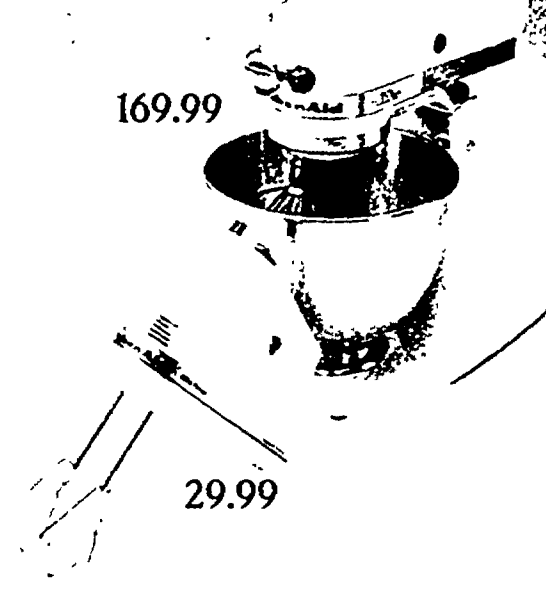

169.99

29.99

**sale 79<sup>99</sup>**

55% off a 2-lb. breadmaker. Extra-large capacity; yeast pre-heat feature. Reg. 179.99

**sale 169<sup>99</sup>**

Classic Stand Mixer. Reg. 229.99  
Ultra Power™ Hand Mixer. Reg. 49.99, sale 29.99

**sale 19<sup>99</sup>**

Snake Light™. Flexible design for hands-free convenience anywhere. Includes 2 C batteries. Reg. 24.99

**sale 89<sup>99</sup>**

World Vac™. 12-amp motor, built-in hose & tools with auto-conversion, Filteraire bag system. Reg. 149.99

**GoldStar**

**Rowenta**

**Bissell**

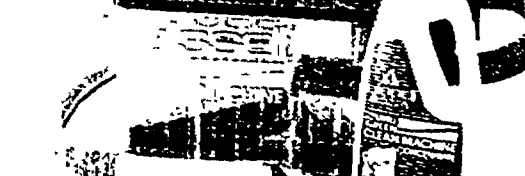

**94.99** After \$20 rebate

GoldStar microwave. 1.0 cu. ft., 850 watts, auto weight defrost. Reg. 219.99, sale 114.99

**sale 34.99**

Powerglide iron. Pivoting cord prevents tangles; auto-off, burst of steam. Reg. 59.99

**sale 74.99**

Little Green Clean Machine. Compact and portable, deep-cleans carpet and upholstery. Reg. 99.99

**sale 49.99**

Boss upright vac. Top-fill bag, 6 height adjustments, power-driven brush roll. Reg. 79.99



**BLACK & DECKER**



**sale 39.99**

Toast-R-Oven™ Broiler. 4-slice toast capacity with continuous cleaning interior. Reg. 64.99

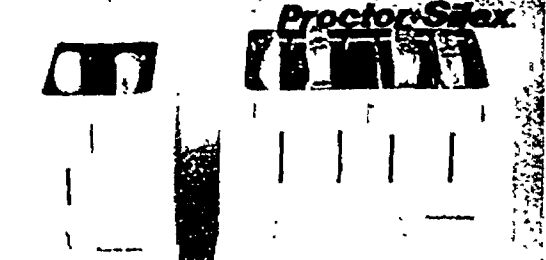

**14.99 & 24.99**

2-or 4-slice toaster. Extra-wide slots, self-adjusting guides, cool-touch. Reg. 27.99 & 44.99



**sale 49.99**

T-Fal® deep fryer. Adjustable thermostat, locking lid, exterior basket control. Reg. 79.99

**BLACK & DECKER**



**sale 49.99**

Power Pro® food processor. 6-cup capacity. Slices, shreds, chops, mixes. Dishwasher safe. Reg. 69.99

**19.99**

Your Choice  
Braun 10-cup coffee maker or West Bend® 4-qt. slow cooker. Reg. 34.99 & 24.99

**WEST BEND**



**BRAUN**

**HO MEDICS INCORPORATED**

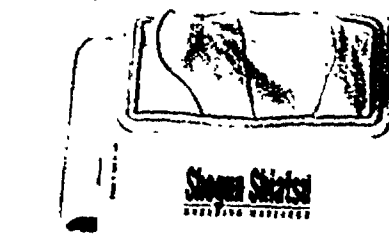

**sale 24.99**

Shogun Shiatsu™ massager. Reg. 34.99  
Sole Therapy™ foot spa. Use wet or dry. Reg. 34.99, sale 24.99

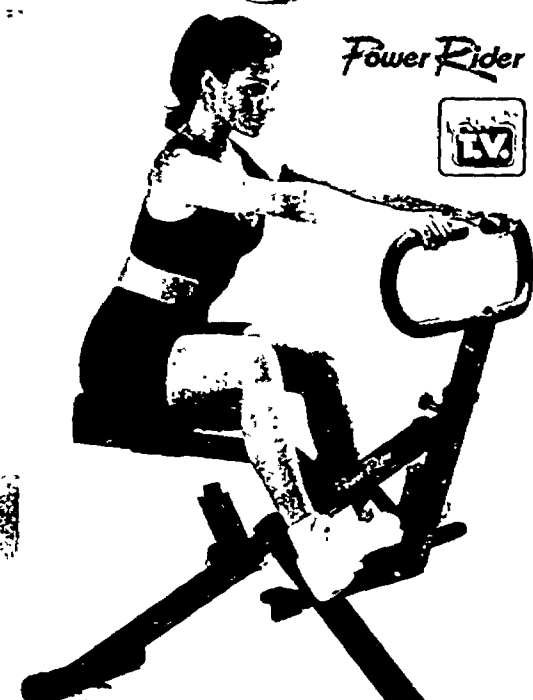

**sale 149<sup>99</sup>**

Power Rider™. Reg. 199.99  
20-33% off all other fitness. Reg. 59.99-299.99, sale 39.99-239.99



**40-50% Off**

**Entire Stock Bath Towels**

Choose from a wide variety of jacquards, prints and embellished styles. Reg. 2.99-35.99, sale 1.49-17.99

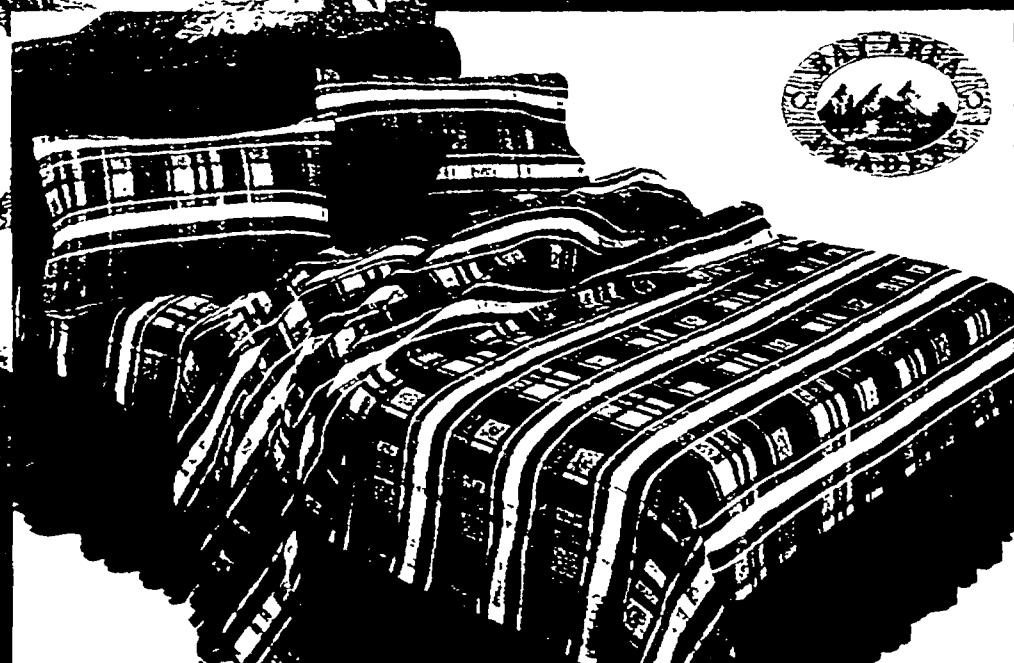

**33% Off**

**Entire Stock**  
Bay Area Traders® 100% cotton flannel sheet sets. New deep-fitted construction. Reg. 29.99-69.99, sale 20.09-46.89

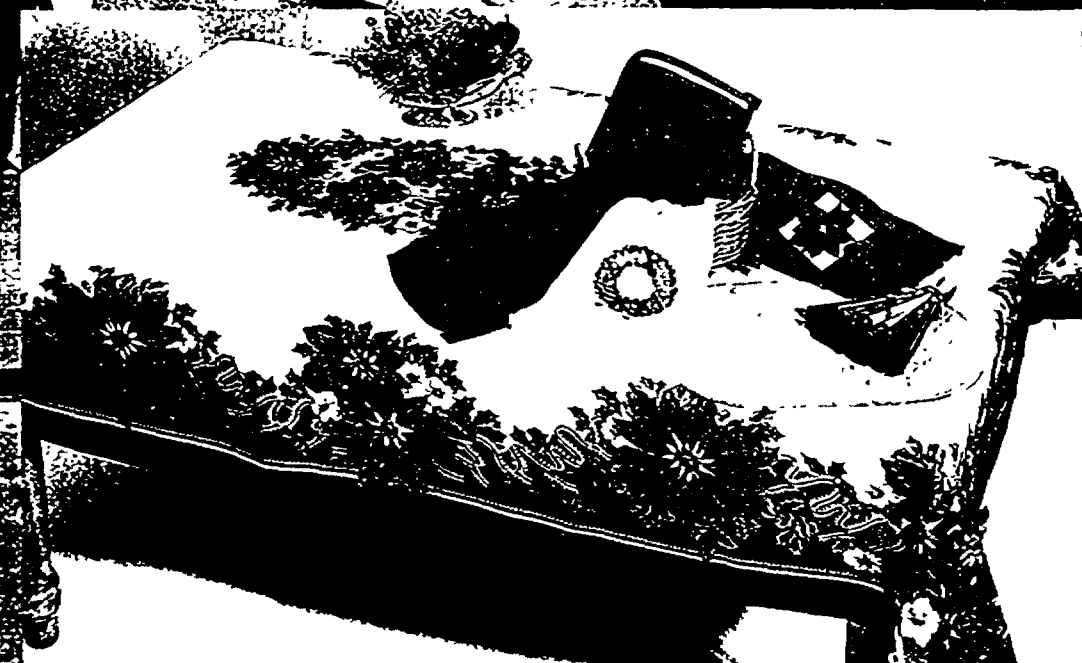

**33-40% Off**

**Entire Stock**  
Holiday table linens and coordinates. Tablecloths, napkins, placemats and kitchen textiles. Reg. .99-59.99, sale .66-40.19

# 20-50% Off Bedding, Bath & Home Items



**save 50%**

Cotton and acrylic throws. Includes cotton wall hangings. Reg. 14.99-54.99, sale 7.49-27.49



**sale 17.49**

50% off Cannon Royal Family Polar One Fleece throws. 8 colors, whipstitch detail. 48x60". Reg. 34.99



**save 40%** Entire Stock

Bed pillows, mattress pads and accessories. Reg. 2.99-84.99, sale 1.79-50.99

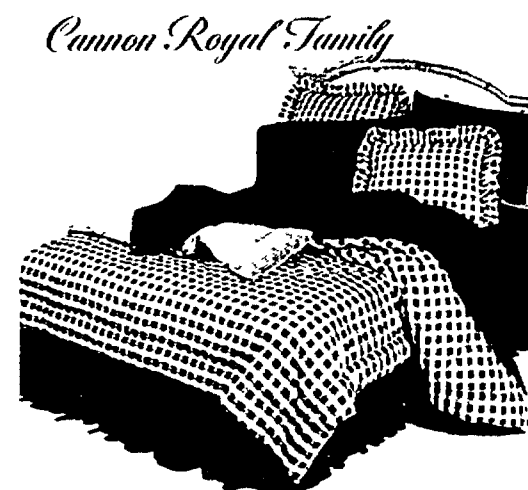

**2/\$7** Twin Solid Sheets  
Reg. 6.99 ea.

Other sizes, sale 2/\$18 & 2/\$32  
Checks & prints, sale 2/\$10 to 2/\$34  
Comforters & access., 9.99-55.99



**sale 15.99** Twin

Kids At Play sheet sets. Reg. 21.99 Full-size sets. Reg. 32.99, sale 24.99 Comforters & blankets, 8.99-34.99

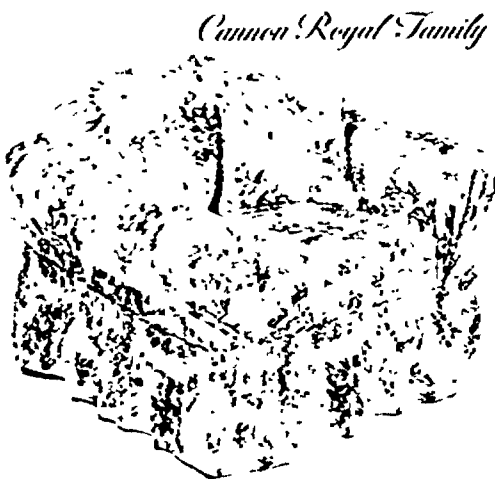

**save 33%** Entire Stock

Slipcovers. Includes chair and sofa covers, ex-large sofa covers and coordinating pillows. sale 7.99-99.99

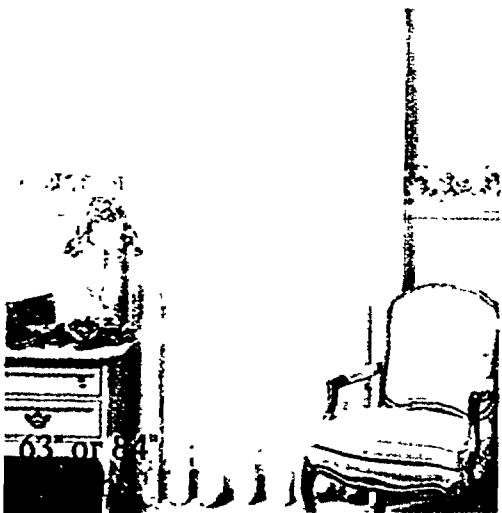

**12.99** Your Choice  
Reg. 19.99 ea.

Barbara Lace swag or lace panels. 33% off window coverings, 6.69-46.89 25% off drapery hardware, 1.11-22.49

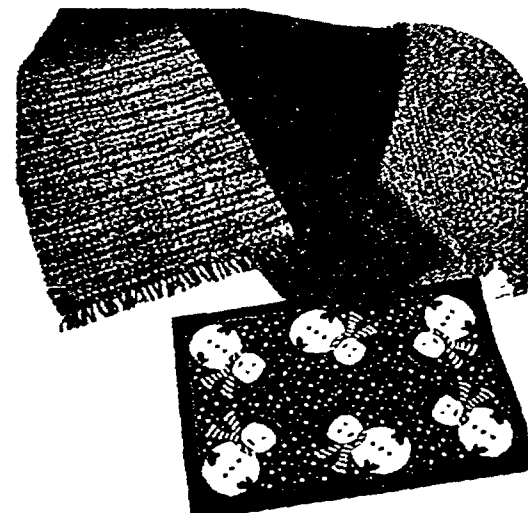

**save 33%** Entire Stock

Accent rugs. Cotton jacquards, braids, d'hurries, tufted, holiday styles & more. Reg. 3.99-169.99, sale 2.67-113.89



**save 33%** Entire Stock

Decorative pillows and chair pads. Holiday & everyday patterns; tapestries, prints and solids, sale 4.01-20.09



**save 33%** Entire Stock

Table linens and kitchen textiles. Placemats, tablecloths, kitchen towels, potholders & more, sale .66-30.81



**save 33%** Entire Stock

Bath accessories. Rugs, scales, plastic and ceramic accessories, shower curtains and more, sale 1.33-66.99



**save 33%** Entire Stock

Holiday bath items. Festive, fun bath towels, ceramics, plastic rugs, and other novelty items, sale 1.99-16.74



**18.99** Your Choice

Solitaire or Yahtzee hand-held games. Reg. 29.99-34.99  
50% off all other casino games, sale 9.99-29.99

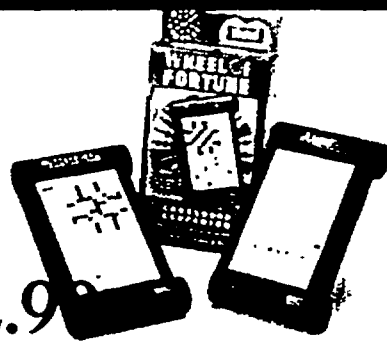

**12.99**  
Crossword Companion.  
For wordsmiths. Reg. 19.99  
30% off refills, sale 4.19

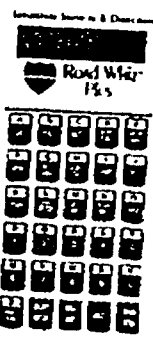

**34.99**  
Road Whiz™. Find the nearest city, hotel, restaurant, more. Reg. 59.99



**12.99**  
Tropic Paradise. Battery operated fish tank with two fish. Reg. 19.99



**save 40%**  
Entire stock wrap.  
Bags, bows & more.  
Reg. .99-7.99,  
sale .59-4.79  
Excludes Halmark.

**33%** Entire Stock  
Off St. Nicholas Square®  
**Trim The Home**

•Ornaments  
•Village Houses  
•Accessories

•Snow Globes  
•Musicals  
•Home Decor

•Wall Decor  
•Christmas Lights  
•Gourmet Food

•Boxed Cards  
Reg. .99-59.99,  
sale .66-40.19  
Excludes Halmark

**KOHL'S**

*That's more like it.*

Prices good Friday and Saturday,  
November 29 and 30, 1996.

Sale includes only those items designated as sale priced. Clearance merchandise is excluded from entire stock categories herein.

FOR THE  
KOHL'S STORE  
NEAREST YOU, CALL

**1-800-837-1500**

# R

# RadioShack<sup>SM</sup>

You've got questions. We've got answers.<sup>®</sup>

# Most Wanted Gifts!

Most stores open 8:30 a.m. until 9:30 p.m. this Friday and Saturday, 10:00 a.m. until 8:00 p.m. Sunday!

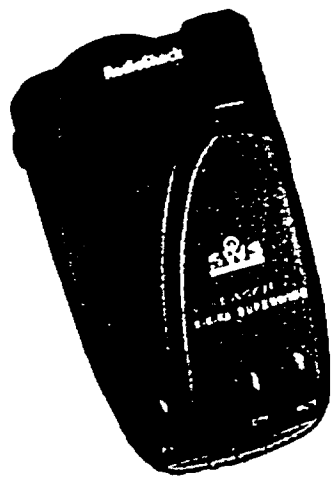

**99<sup>99</sup>**  
**SAVE \$70**  
**Radar/laser detector**

V6-2 Guard road hazard  
 detector. 2000 MHz. 2000 MHz.  
 2000 MHz. 2000 MHz.

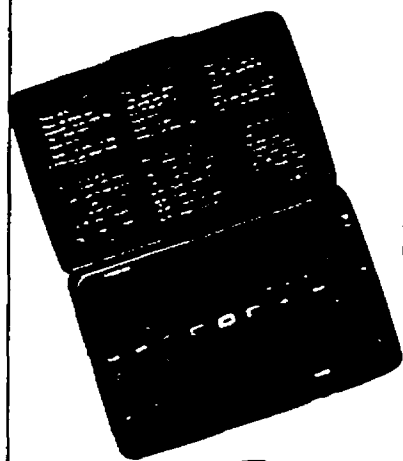

**69<sup>99</sup>** **Franklin**  
**SAVE \$10**  
**Bookman™ pocket King James Bible**

Full concordance with search. Book's cut-edge soft-let's you add a search key anytime. Over 100 cartridges available. 2000 MHz. 2000 MHz. 2000 MHz.

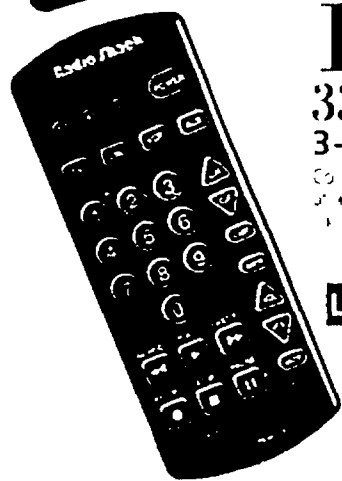

**19<sup>99</sup>**  
**33% OFF**  
**3-in-1 remote**

Control TV, VCR, stereo, video. 2000 MHz. 2000 MHz. 2000 MHz.

**Lighted keys!**



**19<sup>99</sup>**  
**33% OFF**  
**Cassette recorder**

Easy way to take notes for school or work. Uses standard size tapes. reg. 29.99. #12120. 2000 MHz. 2000 MHz. 2000 MHz.

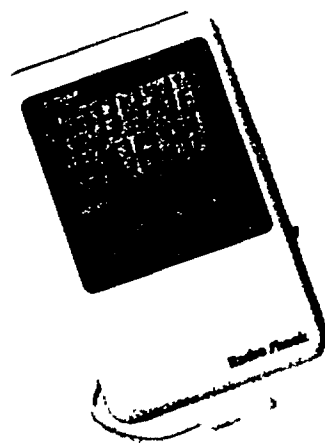

**14<sup>99</sup>**  
**31% OFF**  
**Indoor/outdoor thermometer**

Easy to read display. Memory records high/low temp. For desk or wall mount. reg. 21.99. #631625. 2000 MHz. 2000 MHz. 2000 MHz.



**2<sup>99</sup>**  
**25% OFF**  
**Pencil sharpener**

Works anywhere. Includes spare blade. reg. 3.99. #612768. Add 4 "AA" batteries.

**Cordless!**



**189<sup>99</sup>**

**SAVE \$110**  
**Easy-to-use scanner**

Searches for police, fire, ambulance, and more. 2000 MHz. 2000 MHz. 2000 MHz.

**Hear police, fire & more!**



**29<sup>99</sup>**  
**11% OFF**  
**AM/FM stereo cassette gift pack**

Includes 10 cassettes. reg. 32.99. #12120. 2000 MHz. 2000 MHz. 2000 MHz.

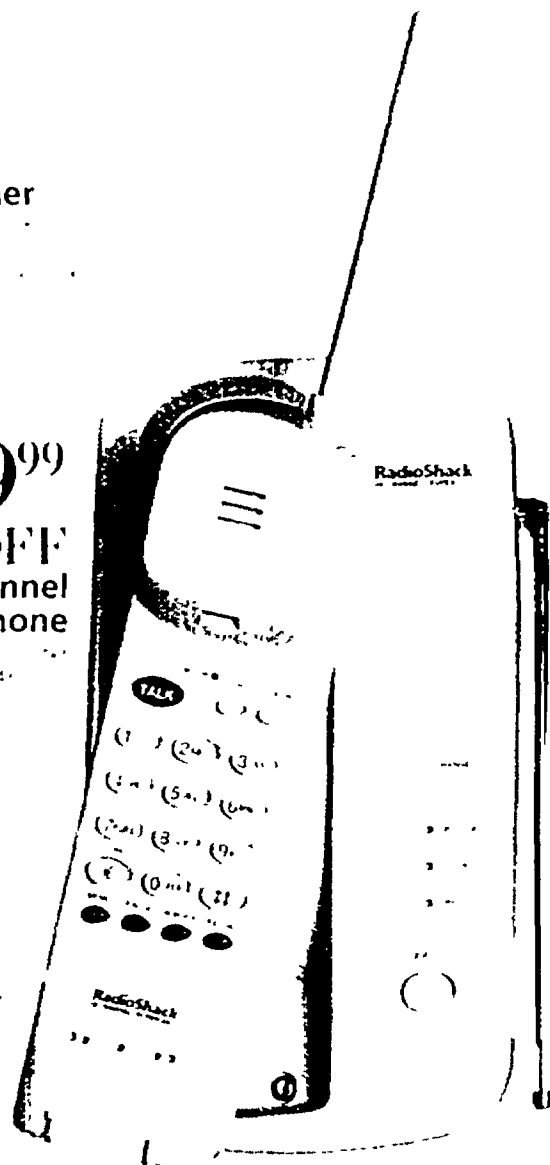

**49<sup>99</sup>**

**28% OFF**  
**10-channel cordless phone**

2000 MHz. 2000 MHz. 2000 MHz.



**39<sup>99</sup>** **33% OFF**  
**Fun-to-play keyboard**

With 37 mid-size keys. 18 demo tunes, 12 rhythms, dual speakers. reg. 59.99. #424031. Add 4 "C" batteries or AC adapter #27316625.



**59<sup>99</sup>** **33% OFF**  
**Rolodex® phone directory**

Pocket/purse size. Stores 1,000 expanded entries. Search. Shares data with other directories. reg. 89.99. #653395. Rolodex is a registered trademark of Rolodex.



**79<sup>99</sup>** **SAVE \$20**  
**Portable CD player**

Extended Bass boosts lows. Up to 7-hour battery life! reg. 99.99. #425065. Add 4 "AA" batteries or adapter AC #273166151. DC #273180151.

**WE CAN GIFT-BOX IT, ADD A CARD & SEND IT ANYWHERE IN THE US!**

See back page





# No Ordinary Deal.

## No Interest Until 1998 on IBM Computers!

No payments until 1997. Interest accrues from date of purchase. \$1,999 minimum purchase required.

\*Offer only for purchase of personal systems made on the RadioShack Credit Card. Subject to credit approval. Minimum purchase \$1,999. Finance Charges will accrue during the deferred period from the date of purchase, but to avoid having these Finance Charges added to your account you must: (i) make the minimum payment required on your purchase each month beginning with the billing statement that you receive in January 1997, (ii) make all other required payments on your account, and (iii) pay the full amount of your purchase by the end of the deferred period. Beginning in January 1997, the required monthly payment on your purchase will be 1/48th of the balance that you owe, plus the monthly premium for any credit insurance, if you have purchased such coverage. If the prime interest rate disclosed in the Wall Street Journal on the last business day of each month exceeds 8.25%, the required monthly payment on your purchase will be 1/45th of the balance that you owe, plus credit insurance. As of September 9, 1996, Best Rate APR: 22.65%, Standard Rate APR: 24.65% (rates may vary). Minimum Finance Charge 50¢. (Except PR). Offer expires December 31, 1996. See store for complete details.

# No Ordinary Computers.

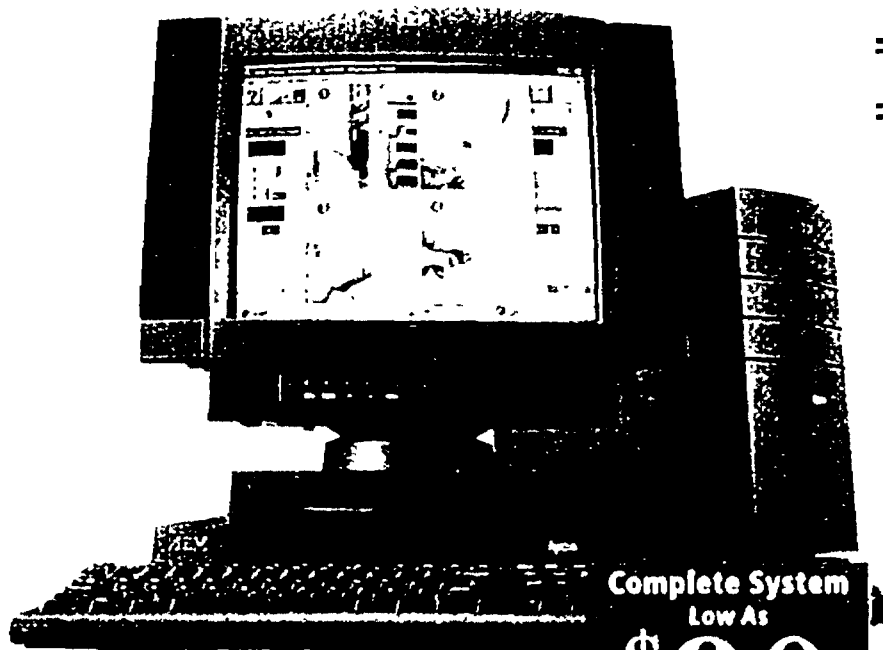

IBM  
Aptiva

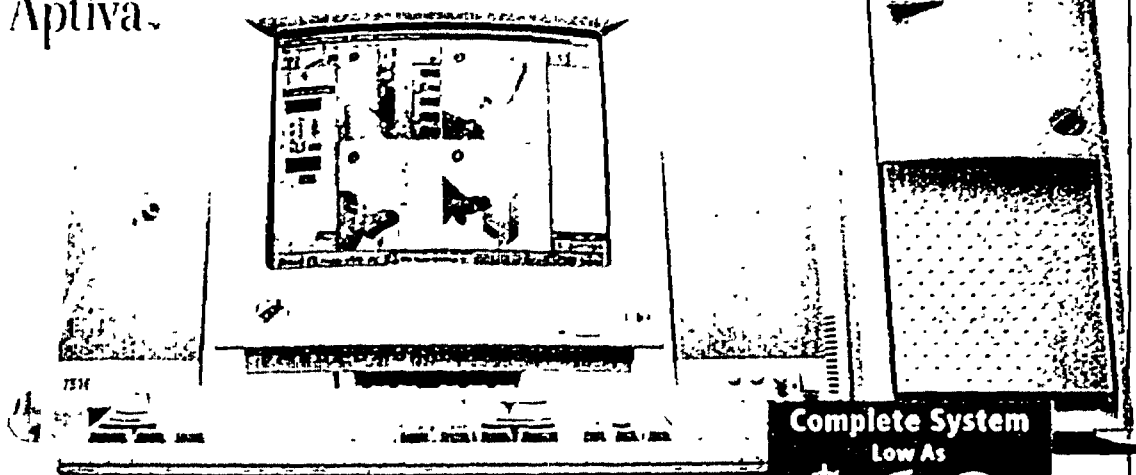

### Basic Black? Hardly!

The new IBM Aptiva S series computer looks different because it is.

Complete System  
Low As  
**\$80**  
Per Month\*  
Taxes not included  
Includes  
multimedia monitor  
& color ink-jet printer

- 21" Multimedia monitor with 1024x768 resolution
- 16MB memory, expandable to 32MB
- CD-ROM drive
- 28.8Kbps modem with fax/modem capability
- 15" monitor (13.1" diagonal viewable area) with built-in stereo speakers
- Includes 95 QuickView™ SmallScreen™ feature
- Keyboard
- Mouse
- IBM Aptiva S series computer system (without monitor or printer) \$3,499. Low As \$73 Per Month. Taxes not included.

LEXMARK

Lexmark 2050 color ink jet printer (black)

\$259.99  
SAVE \$20

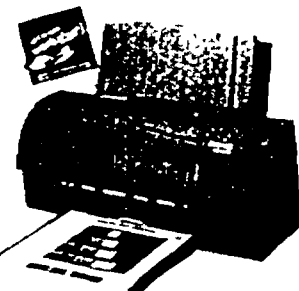

LEXMARK

Lexmark 2050 color ink jet printer (white)

\$274.99  
SAVE \$20



### The House & Family PC.

21st Century Home Automation!  
Arcade-Style Graphics! Total Communications!

Complete System  
Low As  
**\$62**  
Per Month\*  
Taxes not included  
Includes  
IBM color monitor &  
color ink-jet printer

- 21" IBM color monitor with 1024x768 resolution
- 16MB memory, expandable to 32MB
- CD-ROM drive
- 28.8Kbps modem with fax/modem capability
- 15" monitor (13.1" diagonal viewable area) with built-in stereo speakers
- Includes 95 QuickView™ SmallScreen™ feature
- Keyboard
- Mouse
- IBM Aptiva S series computer system (without monitor or printer) \$3,499. Low As \$73 Per Month. Taxes not included.

### Both of these IBM Aptiva PCs feature Total Image 3D™ & Home Director™

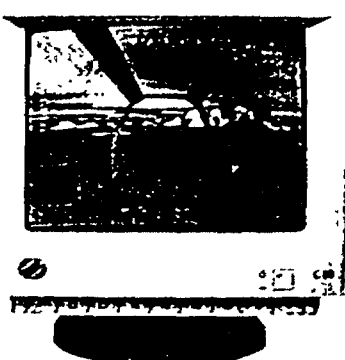
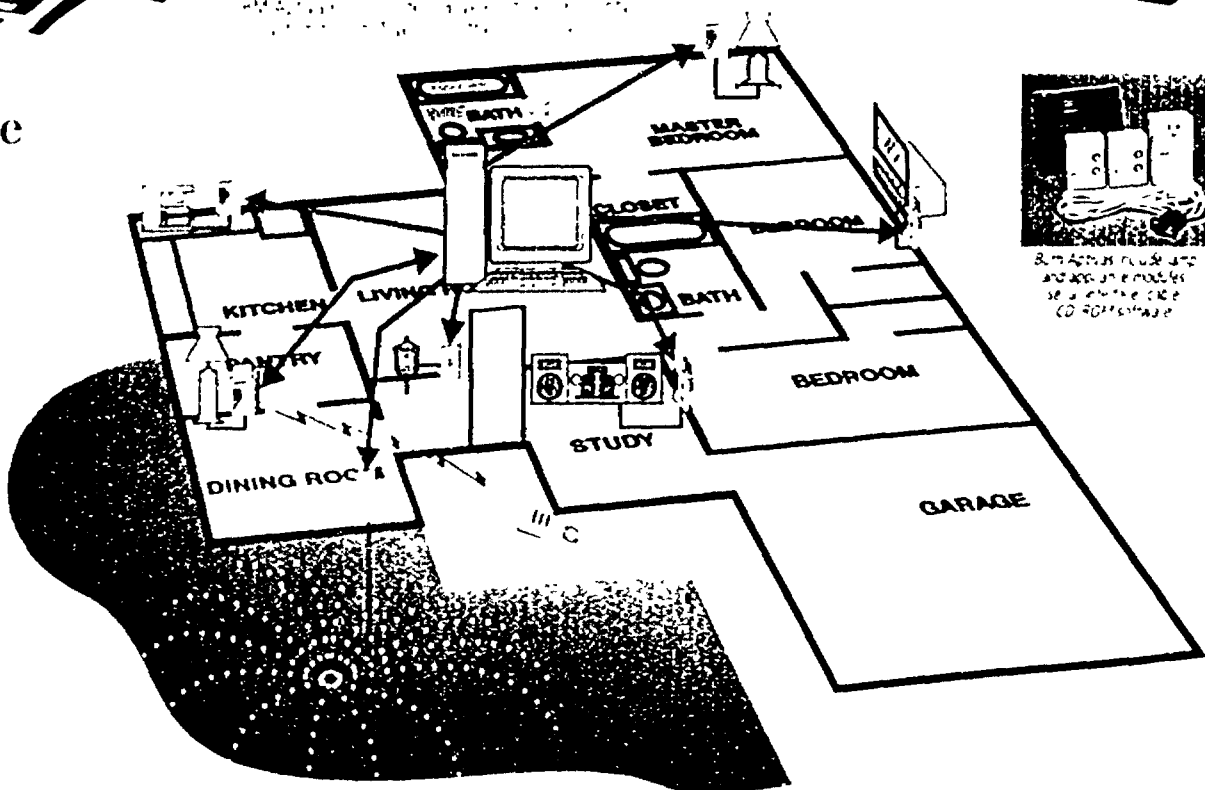

#### Total Image 3D Video

Experience life like graphics like never before. With either Aptiva you're ready for the next generation of 3-D software titles, including those using the Direct 3-D™ standard by Microsoft. Get a look at what's coming with the included MechWarrior 2 3-D Rage Edition™ and VR Soccer™ software.

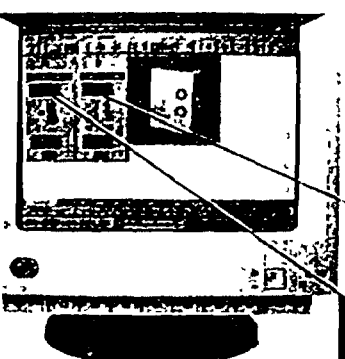

#### IBM's Home Director automates your home

Home Director is the easy, low cost way to run customized light and appliance routines that simplify your schedule, save time and improve security by giving your home a "lived in" look while you're away. There are no wires to run and no expensive installation charges. Expanding the system is easy too. Home Director is compatible with RadioShack Plug 'n Power (at night) and other leading wireless remote control systems.

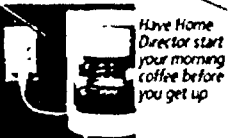

Have Home Director start your morning coffee before you get up.



IBM's Home Director can dim, brighten & turn lights on & off automatically.

100% Compatible with IBM Home Director!



**29<sup>99</sup>** 26% OFF  
Wireless lighting control system

No more crawling under the tree—works with or without IBM Aptiva and Home Director to turn lights on/off from anywhere in your home. Includes control center, on/off remote module and lamp dimmer module. Use year-round to control lamps and appliances. Easy to expand. Reg. separate items 4097, #61 26775L, #61 26815L, #61 26825L.

IBM, the IBM logo, IBM Home Director and Total Image 3D are trademarks of IBM Corp. Personal is a registered trademark of Intel Corp. Direct 3-D is a trademark of Microsoft Corp. MechWarrior 2 and VR Soccer are trademarks of Sega Enterprises, Ltd. © 1996 IBM Corp. All rights reserved. IBM, the IBM logo, IBM Home Director and Total Image 3D are trademarks of IBM Corp. Personal is a registered trademark of Intel Corp. Direct 3-D is a trademark of Microsoft Corp. MechWarrior 2 and VR Soccer are trademarks of Sega Enterprises, Ltd. © 1996 IBM Corp. All rights reserved. IBM, the IBM logo, IBM Home Director and Total Image 3D are trademarks of IBM Corp. Personal is a registered trademark of Intel Corp. Direct 3-D is a trademark of Microsoft Corp. MechWarrior 2 and VR Soccer are trademarks of Sega Enterprises, Ltd. © 1996 IBM Corp. All rights reserved.



RadioShack  
Gift Express™

#### The fast, easy way to send great gifts!

Forget brown wrapping paper and lines at the post office. Use RadioShack Gift Express to send gifts like portable CD players, phones, pocket TVs and RC cars. We'll wrap it, add a personalized card and ship it anywhere in the USA via UPS® delivery service. All for a nominal charge. Stop in and let us help you choose from our great selection of electronics! To send a gift, visit your nearby RadioShack or call 1-800-THE-SHACK™.

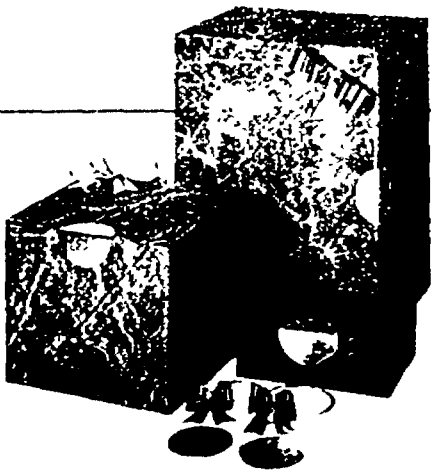

RadioShack<sup>SM</sup>  
You've got questions.  
We've got answers.®

Prices apply at participating RadioShack stores and dealers. Items not available at a participating store can be special ordered (subject to availability) at the advertised price. A participating store will offer a comparable value if the product is sold out. Independent RadioShack dealers and franchisees may not be participating in this ad or stock or special order every item advertised. See inside for RadioShack policy on advertised items and for obtaining warranty information. Sale prices good through 12/24/96.

MUSIC • SOFTWARE

MOVIES • BOOKS

# MEDIA PLAY<sup>®</sup>

## 25% OFF ALL BOOKS

## ALL CDs\* 11.99 OR LESS

\*Excludes extended-play versions, super hi-fidelity recordings, special editions, multi-disc sets and single CDs with a manufacturer's list 17.98 and above.

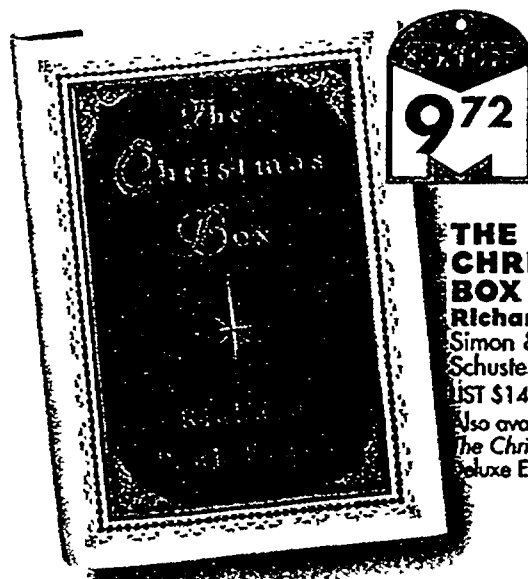

972

**THE CHRISTMAS BOX**  
Richard Paul Evans  
Simon & Schuster - HC  
LIST \$14.95  
Also available:  
The Christmas Box  
Deluxe Edition

SAVE OVER \$4  
**14.99**  
**FREE**  
\$50 IN BONUS  
SAVING COUPONS  
GOOD ON FOX  
MOVIE TITLES!  
V.P.P.



**INDEPENDENCE DAY**  
Fox SRP 19.95

**FREE!**  
LIMITED EDITION  
SERICEL WITH  
PURCHASE!

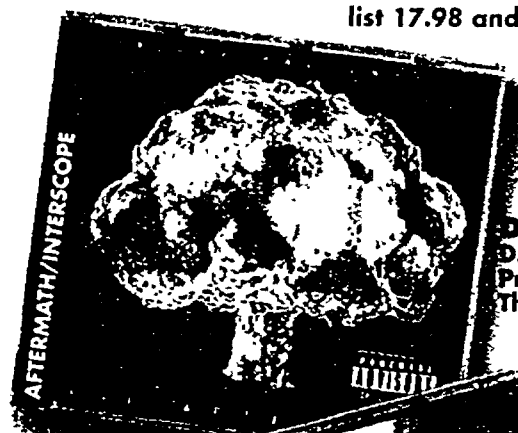

**DR. DRE**  
Dr. Dre  
Presents...  
The Aftermath



25% OFF  
971

**FUGITIVE FROM THE CUBICLE POLICE**  
Scott Adams  
Andrews & McMeel - PB  
LIST \$12.95



14.30

**THE DILBERT PRINCIPLE**  
Scott Adams  
HarperBusiness - HC  
LIST \$22.00

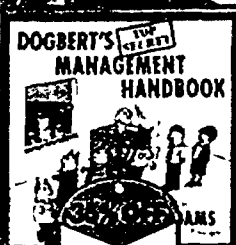

10.40

**DOGBERT'S TOP SECRET MANAGEMENT HANDBOOK**  
Scott Adams  
HarperBusiness - HC  
LIST \$16.00



SAVE OVER \$5  
**13.99**

**GRUMPY OLD MEN**  
Warner SRP 19.95



39.99 soft

**MICROSOFT FLIGHT SIMULATOR 6.0**  
CD-ROM



**BUSH**  
Razorblade Suitcase

## 2 for \$19 3 for \$27

Any movie title with an everyday low price of 12.99-13.99

Excludes BMG and Barney videos from the Lyons Group. Not valid with any other offer.



**MANY MORE TO CHOOSE FROM!**

OVER 2,000 SOFTWARE & GAMES DISCOUNTED EVERY DAY

**3-CD SET**



**WARCRAFT BATTLE CHEST**

**44<sup>99</sup>**

WARCRAFT BATTLE CHEST CD-ROM



**MechWarrior 2 MERCENARIES**

**BUY TWO SELECT ACTIVISION GAMES AND GET TWO FREE (MAIL-IN OFFER). SEE STORE FOR DETAILS.**

**SAVE 34<sup>99</sup>**

**AFTER \$10 INSTANT REBATE**

ACTIVISION

MECHWARRIOR 2 MERCENARIES CD-ROM



**Disney's 101 DALMATIANS ANIMATED STORYBOOK**

**NEW!**

**34<sup>99</sup>**

101 DALMATIANS: ANIMATED STORYBOOK CD-ROM

**OVER 1000 GAMES**

**CD-ROM SOFTWARE SALE**

**7<sup>99</sup> - 9<sup>99</sup>**

**MANY TITLES TO CHOOSE FROM!**

Quantities limited. Selection varies by store.

**WHERE IN THE U.S.A. IS CARMEN SANDIEGO?**

CD-ROM



**24<sup>99</sup>**

**TERRY BRADSHAW FOOTBALL '97**

CD-ROM



**34<sup>99</sup>**

**MYST**

The Surrealistic Adventure That Will Become Your World



**24<sup>99</sup>**

**TROPHY BASS 2**

CD-ROM



**39<sup>99</sup>**

**Interactive Reading Journey 2**

CD-ROM



**69<sup>99</sup>**

**NORTON ANTI-VIRUS 2.0**

CD-ROM



**59<sup>99</sup>**

**AREA 51**

CD-ROM



**39<sup>99</sup>**

**Quicken DELUXE**

Organizes Finances Painlessly and Much More...

**NEW 97**

**59.99 Intuit Rebate Mail-in -20.00**

**39.99 FINAL COST**

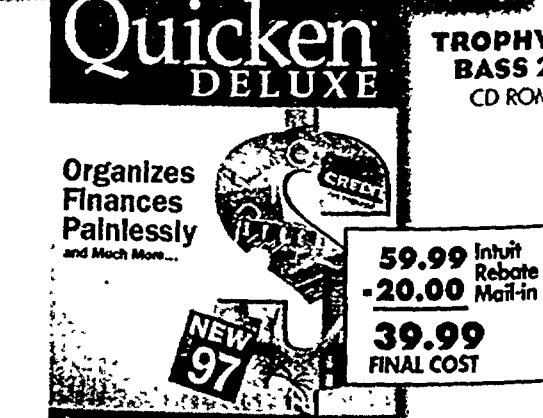

QUICKEN 6.0 DELUXE CD-ROM

# 25% OFF ALL BOOKS!



**TIM ALLEN**  
I'M NOT REALLY HERE

25% OFF  
**14<sup>27</sup>**

**I'M NOT REALLY HERE**  
Tim Allen  
Hyperion - HC UST \$21.95

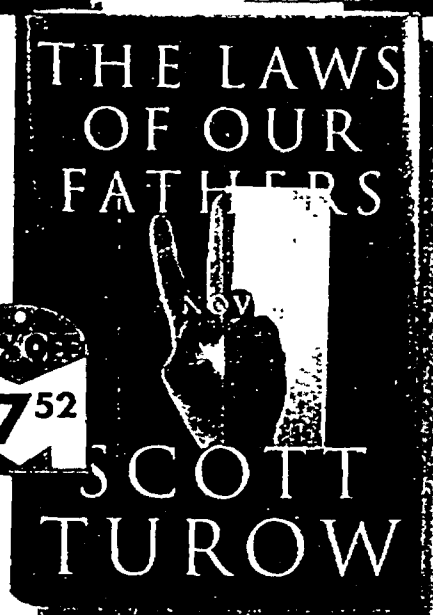

THE LAWS OF OUR FATHERS

25% OFF  
**17<sup>52</sup>**

**THE LAWS OF OUR FATHERS**  
Scott Turow  
Farrar, Straus & Giroux - HC UST \$26.95

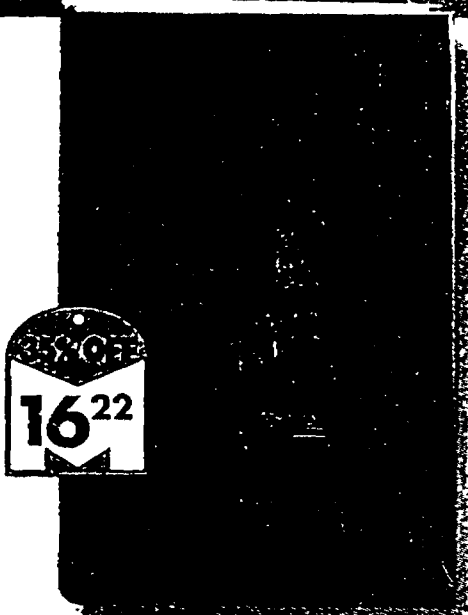

25% OFF  
**16<sup>22</sup>**

**SILENT HONOR**  
Danielle Steel  
Delacorte - HC UST \$24.95

25% OFF  
**11<sup>21</sup>**

**101 DALMATIANS: ILLUSTRATED CLASSIC**  
Anne Mazer  
Disney Press  
UST \$14.95

25% OFF  
**5<sup>24</sup>**

**101 DALMATIANS: MOVIE STORYBOOK**  
Mouse Works  
UST \$6.98

25% OFF  
**2<sup>24</sup>**

**101 DALMATIANS: LITTLE LIBRARY**  
P. Z. Mann  
Western  
UST \$2.99

More 101 Dalmatians books available!

## 35% OFF ALL NEW YORK TIMES HARDCOVER BESTSELLERS!



**KEN FOLLETT**  
THE THIRD TWIN

35% OFF  
**16<sup>87</sup>**

**THE THIRD TWIN**  
Ken Follett  
Crown - HC UST \$25.95



**THE REGULATORS**

35% OFF  
**16<sup>22</sup>**

**THE REGULATORS**  
Richard Bachman  
Dutton - HC UST \$24.95



**DESPERATION**

35% OFF  
**18<sup>17</sup>**

**DESPERATION**  
Stephen King  
Viking - HC UST \$27.95

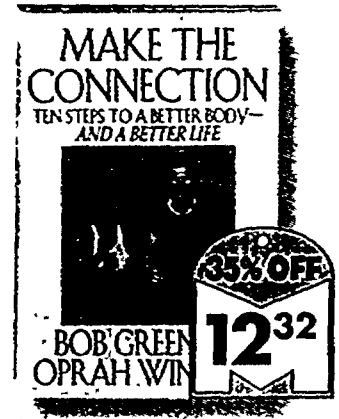

**MAKE THE CONNECTION**  
TEN STEPS TO A BETTER BODY—AND A BETTER LIFE

35% OFF  
**12<sup>32</sup>**

**MAKE THE CONNECTION**  
Bob Greene & Oprah Winfrey  
Hyperion - HC UST \$18.95

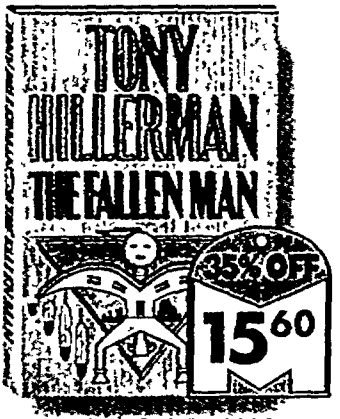

**THE FALLEN MAN**

35% OFF  
**15<sup>60</sup>**

**THE FALLEN MAN**  
Tony Hillerman  
HarperCollins - HC UST \$24.00

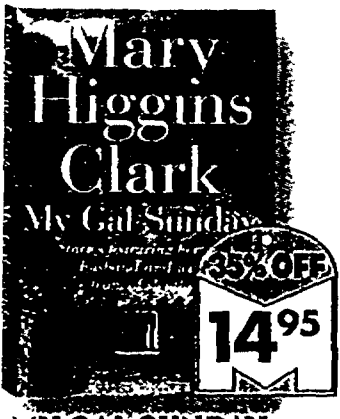

**Mary Higgins Clark**  
MY GAL SUNDAY

35% OFF  
**14<sup>95</sup>**

**MY GAL SUNDAY**  
Mary Higgins Clark  
Simon & Schuster - HC UST \$23.00

HOLIDAYS

**THE CHRISTMAS TREE**  
Julia Salamon  
Random House - HC UST \$12.95

**THE CHRISTMAS MIRACLE OF JONATHAN TOOMEY**  
Susan Wojceichowski  
Candlewick - HC UST \$17.99

**CHRISTMAS EVERY DAY**  
William Dean Howells  
Pocket - HC UST \$8.00

**HOLIDAYS**  
Martha Stewart  
Clarkson Potter - PB UST \$20.00

**THIS YEAR IT WILL BE DIFFERENT**  
Maeve Binchy  
Delacorte - HC UST \$15.95

**THE TWELVE DAYS OF CHRISTMAS**  
Robert Sabuda  
Little Simon - HC UST \$19.95

**MARTHA STEWART'S CHRISTMAS**  
Martha Stewart  
Clarkson Potter - PB UST \$18.00

**WREATHS**  
Martha Stewart  
Clarkson Potter - PB UST \$20.00

# ALL CDs\* \$11.99 OR LESS!

**NIRVANA**  
From the Muddy  
Banks of the Wishkah



**KENNY G**  
The Moment



\*Excludes extended-play versions, super hi-fidelity recordings, special editions, multi-disc sets and single CDs with a manufacturer's list 17.98 and above.



**2 PAC/MAKAVELI**  
The Don Killuminati -  
The 7 Day Theory

**DAVE MATTHEWS  
BAND**  
Crash



**OUTKAST**  
Aliens

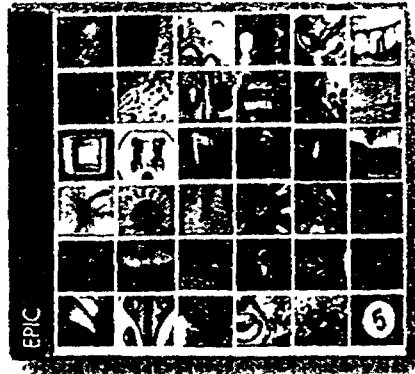

**PEARL JAM**  
No Code

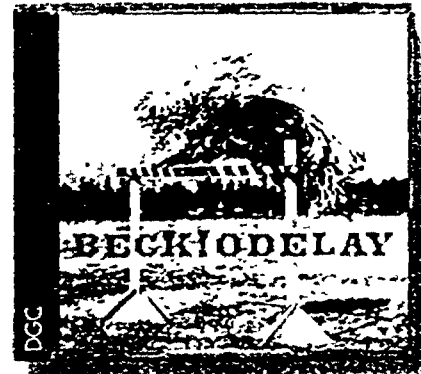

**BECK**  
Odelay



**OASIS**  
(What's the Story)  
Morning Glory?



**TONI BRAXTON**  
Secrets

# THOUSANDS OF CDs UNDER \$10!

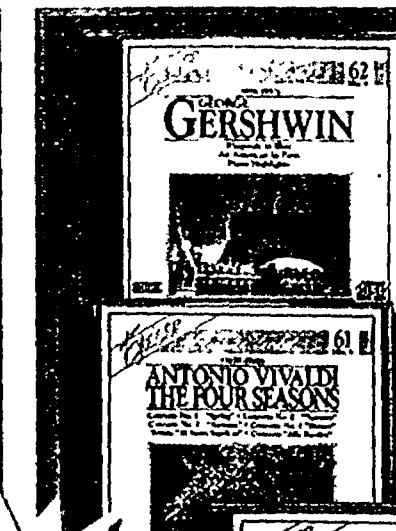

**FREE**  
Excelsior CD\* WITH GIFT BOX  
WHEN YOU PURCHASE ANY  
MEDIA PLAY GIFT CERTIFICATE  
OF \$25 OR MORE.  
SEE STORE FOR DETAILS.  
\$4.99 OR LESS.

# OVER 60,000 CDs ON SALE NOW!

THE PRESIDENTS OF THE UNITED STATES OF AMERICA II

III, THE PRESIDENTS OF THE UNITED STATES OF AMERICA



**SALE**  
**11.99** CD  
**6.99** Cassette

ROBERT MILES DREAMLAND

ROBERT MILES Dreamland

WARNER BROS

COLUMBIA

R.E.M. New Adventures in Hi-Fi

ARISTA

DA BRAT Anutha Tantrum

SO SO DEF/COLUMBIA

Da Brat

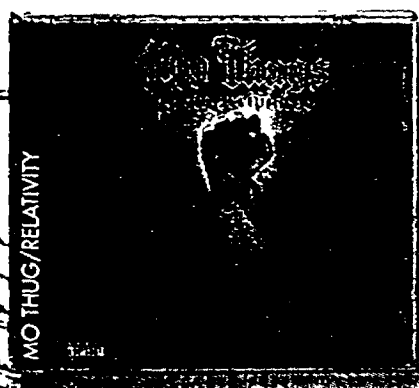

**THE LUV COLLECTION**  
Choose from Hot Luv • Movie Luv  
Real Luv • Smooth Luv

BEAVIS AND BUTT-HEAD DO AMERICA Soundtrack

MO THUGS Family Scriptures

MANHEIM STEAMROLLER Christmas In The Air  
Fresh Aire Christmas • Christmas 1984

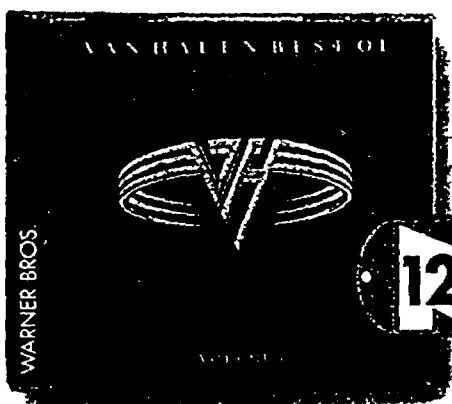

VAN HALEN BEST OF, VOL. 1

12.99 CD  
7.99 Cass.

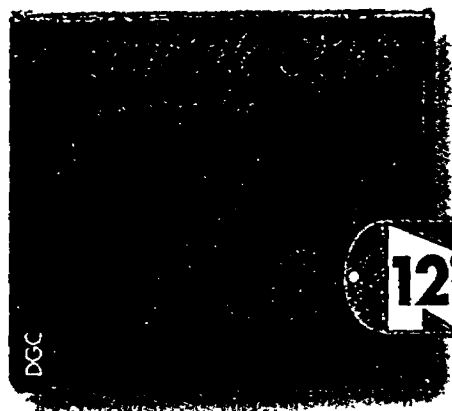

COUNTING CROWS Recovering the Satellites

12.99 CD  
7.99 Cass.

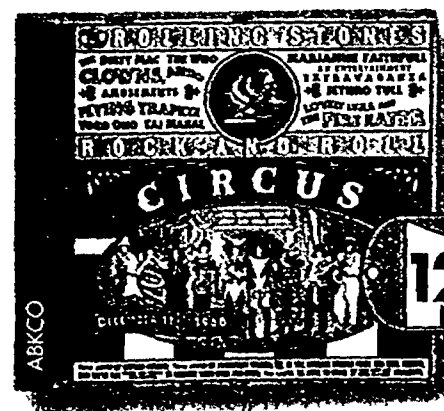

ROLLING STONES Rock and Roll Circus

12.99 CD  
CD only



DANCE HITS '96 SUPERMIX Various Artists

12.99 CD  
7.99 Cass.



THE BEATLES Anthology 3

22.99 CD  
13.99 Cass.



CELINE DION Falling Into You

12.99 CD  
7.99 Cass.



THE SMASHING PUMPKINS Mellon Collie and the Infinite Sadness

16.99 CD  
13.99 Cass.



EVITA Soundtrack  
Featuring Madonna

17.99 CD  
13.99 Cass.

MUSIC SOFTWARE MOVIES BOOKS  
**MEDIA PLAY**

# OVER 15,000 MOVIES DISCOUNTED EVERY DAY

**SAVE OVER \$8**  
**13<sup>99</sup>**

**FREE**  
\$50 IN BONUS SAVINGS COUPONS GOOD ON WARNER/MGM MOVIE TITLES.  
While supplies last.

**TWISTER**  
Warner SRP 22.95

**SAVE OVER \$6**  
**12<sup>99</sup>**

**THE USUAL SUSPECTS**  
PolyGram Video SRP 19.95

**SAVE \$3**  
**6<sup>99</sup>**

**ACE VENTURA: PET DETECTIVE**  
Warner SRP 9.99

**SAVE OVER \$5**  
**8<sup>99</sup>**

**CLUELESS**  
Paramount SRP 14.95

**SAVE OVER \$5**  
**13<sup>99</sup>**

**HEAT**  
Warner SRP 19.95

**SAVE OVER \$5**  
**8<sup>99</sup>**

**DUMB & DUMBER**  
Turner Home Entertainment SRP 14.95

**SAVE OVER \$6**  
**12<sup>99</sup>**

**ASSASSINS**  
Warner SRP 19.95

**SAVE OVER \$6**  
**12<sup>99</sup>**

**DEAD MAN WALKING**  
PolyGram Video SRP 19.95

**SAVE OVER \$5**  
**13<sup>99</sup>**

**GOLDENEYE**  
MGM/UA SRP 19.95

**8 videos!**

**SAVE \$30**  
**69<sup>99</sup>**

**PEE WEE'S PLAYHOUSE COLLECTOR'S GIFT SET**  
MGM/UA SRP 99.99

Savings based on SRP (suggested retail price)

**SAVE OVER \$5**  
**8<sup>99</sup>**

**IT'S A WONDERFUL LIFE**  
Anchor Bay SRP 14.95

**SAVE OVER \$5**  
**8<sup>99</sup>**

**SCROOGED**  
Paramount SRP 14.95

**SAVE OVER \$5**  
**8<sup>99</sup>**

**WHITE CHRISTMAS**  
Paramount SRP 14.95

**SAVE OVER \$5**  
**8<sup>99</sup>**

**HOLIDAY INN**  
MCA/Universal SRP 14.95

**SAVE \$6**  
**6<sup>99</sup>**

**HOW THE GRINCH STOLE CHRISTMAS!**  
MGM/UA SRP 12.99

**SAVE \$6**  
**6<sup>99</sup>**

**RUDOLPH THE RED-NOSED REINDEER**  
Family Home Entertainment SRP 12.99



# ALL DISNEY® MOVIES ON SALE!



**TOY STORY**

© Disney Enterprises, Inc. SRP 26.99



**POCAHONTAS**

© Disney Enterprises, Inc. SRP 26.99



**THE MANY ADVENTURES OF WINNIE THE POOH**

© Disney Enterprises, Inc. SRP 26.99

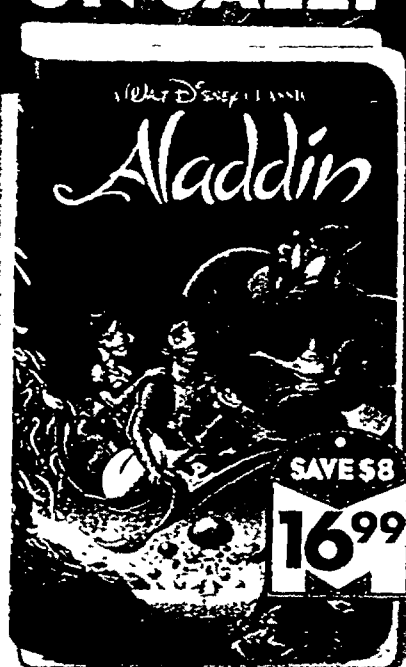

**ALADDIN**

© Disney Enterprises, Inc. SRP 24.99

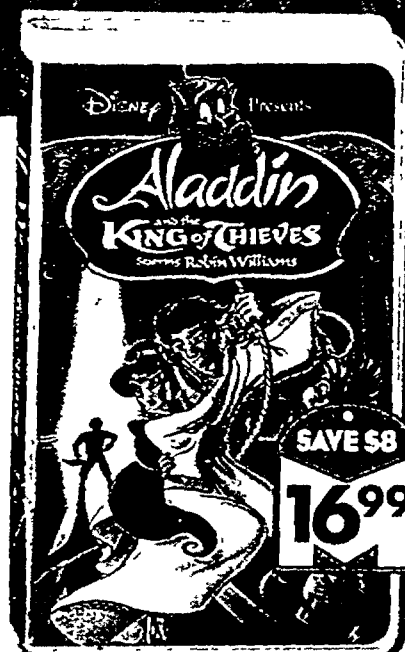

**ALADDIN & THE KING OF THIEVES**

© Disney Enterprises, Inc. SRP 24.99



**HOMEBOUND II**

© Disney Enterprises, Inc. SRP 22.99

Savings based on SRP (suggested retail price)

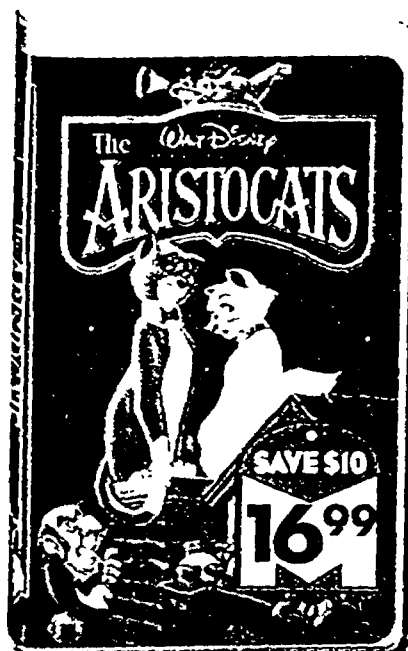

**THE ARISTOCATS**

© Disney Enterprises, Inc. SRP 26.99



**Hurry in for best selection!**



**MUPPET TREASURE ISLAND**

© Disney Enterprises, Inc. SRP 22.99

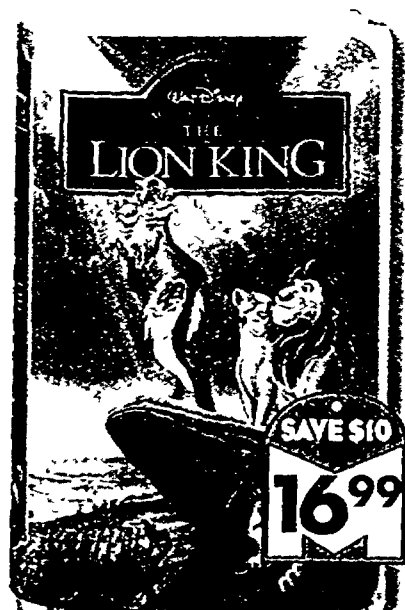

**THE LION KING**

© Disney Enterprises, Inc. SRP 26.99

## WE'RE YOUR PLAYSTATION HEADQUARTERS!



**NFL GAMEDAY '97**  
For PlayStation



**JET MOTO**  
For PlayStation



PlayStation titles may vary by store.

MUSIC • SOFTWARE • MOVIES • BOOKS  
**MEDIA PLAY 7**

# AUDIO AND ACCESSORIES ON SALE!

**FREE**

**ELECTRONICS COUPON BOOK WITH ANY ELECTRONICS PURCHASE OVER \$25! (\$35 VALUE)**



**29<sup>99</sup>**

**SONY WALKMAN<sup>®</sup>**  
MODEL WFMX 123



**89<sup>99</sup>**

Includes Rechargeable Battery!

**SONY DISCMAN<sup>®</sup>**  
PORTABLE CD PLAYER  
MODEL D153

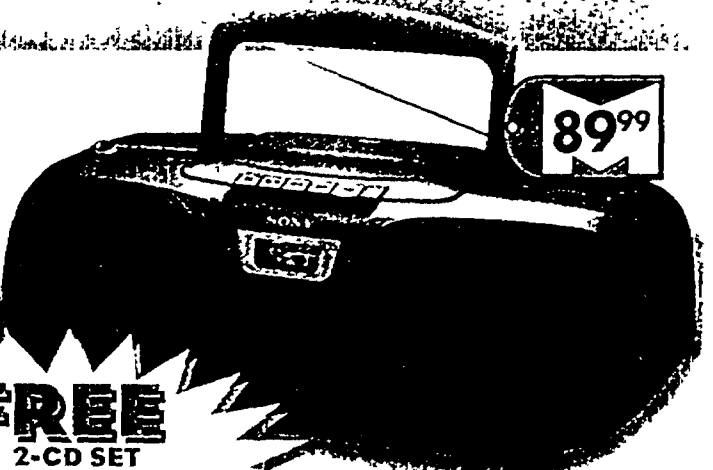

**89<sup>99</sup>**

**FREE**

**2-CD SET MODERN ROCK LIVE WITH PURCHASE OF SELECT SONY CD PLAYERS OR BOOMBOXES (MAIL-IN OFFER)**

**SONY CD BOOMBOX**  
MODEL CFD101



**19<sup>99</sup>**

HOLDS 250 CD'S OR 95 VHS TAPES

**NAPA VALLEY VIDEO AND CD RACK**  
MODEL TR-5



**7<sup>99</sup>**

Save \$5

**CASE LOGIC 12-CD WALLET**  
MODEL CW12



**7<sup>99</sup>**

Save \$5

**KINYO VHS VIDEO REWINDER**  
MODEL UV-520

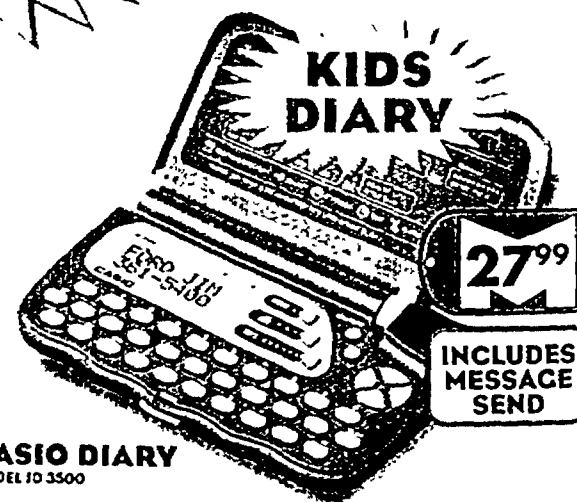

**KIDS DIARY**

**27<sup>99</sup>**

INCLUDES MESSAGE SEND

**CASIO DIARY**  
MODEL 103500

**25% OFF**

**ALL ENERGIZER BATTERIES**

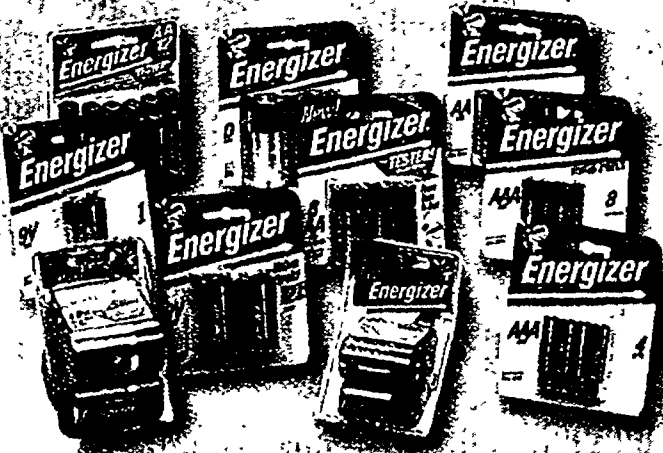

**25% OFF**

**ALL SONY HEADPHONES**



MUSIC • SOFTWARE MOVIES • BOOKS  
**MEDIA PLAY**  
MORE CHOICE. LESS PRICE. EVERY DAY.



Sale ends November 30, 1996.  
81 8947-116

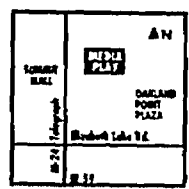

**Oakland Point Plaza**  
Pontiac, MI  
(810) 745-0225

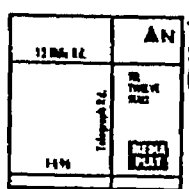

**Tel Twelve**  
Southfield, MI  
(810) 351-0258

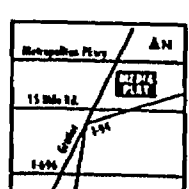

**35220 Gratiot Ave.**  
Clinton Township, MI  
(810) 790-0476

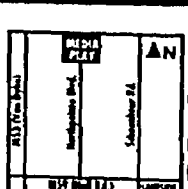

**Northpointe Center**  
Located on M-59  
(Hall Road East of M-53)  
Livonia, MI  
(810) 997-3400

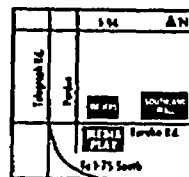

**23269 Eureka Rd.**  
Taylor, MI  
(313) 287-6309

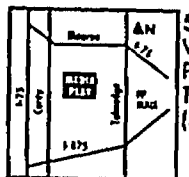

**5223 Monroe St.**  
West of Franklin  
Park Mall  
Toledo, OH  
(419) 843-4488

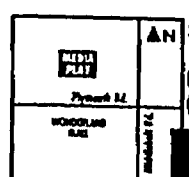

**30000 PLYMOUTH RD.**  
1/4 mile West of Middlebelt Rd.  
Livonia, MI  
(313) 266-9960

**NOW OPEN**

**EXTENDED HOLIDAY STORE HOURS**

**OVER \$40 IN VALUABLE COUPONS ON BACK PAGE!**

# SUNCOAST

MOTION PICTURE COMPANY  
*We Know Movies*

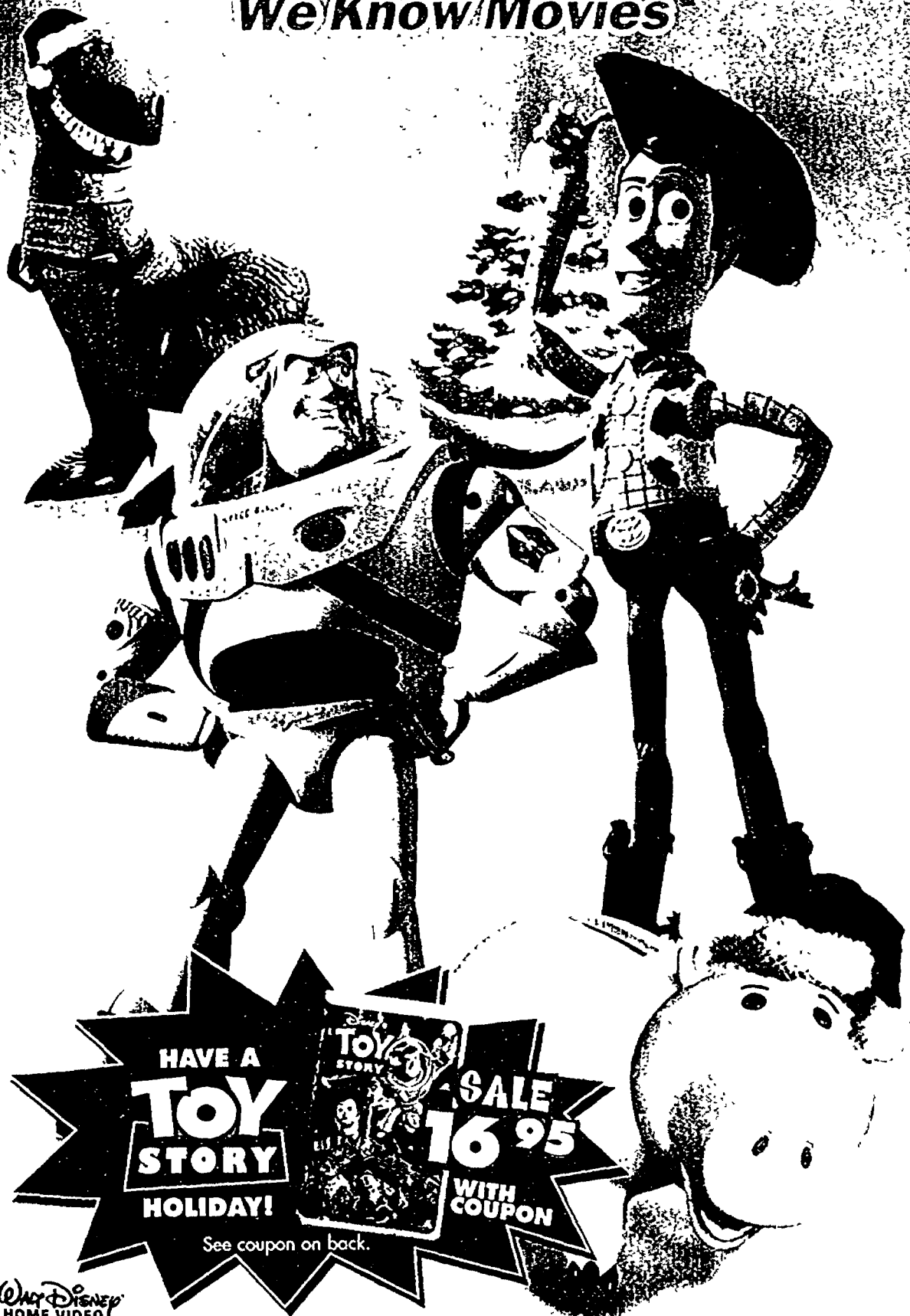

**HAVE A TOY STORY HOLIDAY!**

**SALE 16.95 WITH COUPON**

See coupon on back.

**OVER 10,000 MOVIES TO CHOOSE FROM!**



**SALE 15.99**

**Exclusive Instant Holiday Gift Set**

**ONLY 4.99 WITH COUPON**

Gift Set includes Video Fireplace and A Joyous Season CD.

Book a vacation on THE BIG RED BOAT for a family of four and your kids will cruise FREE! See the coupon enclosed and save up to \$900 for the vacation of a lifetime.

Limit one coupon per visit. Cannot be used in conjunction with any other coupon offer. No reproduction, copy or facsimile accepted. Offer expires December 4, 1996. Enter Markdown Code 303.

**SUNCOAST**  
MOTION PICTURE COMPANY  
*We Know Movies*

**THEY'LL LOVE THE MOVIES.  
YOU'LL LOVE THE PRICE**

**SALE  
\$14.99  
EACH**

SRP 19.95

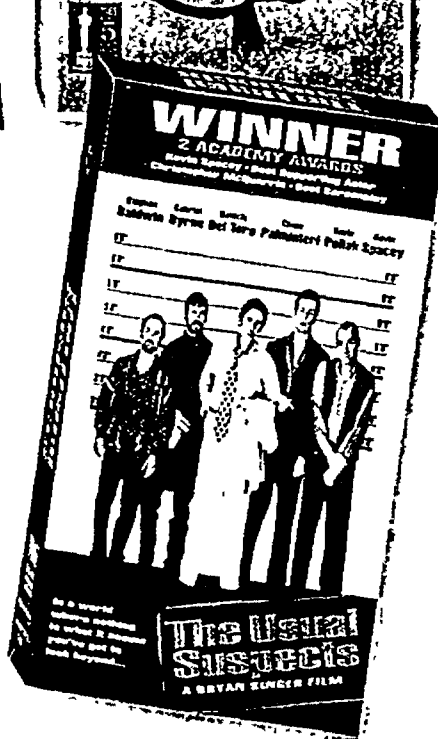
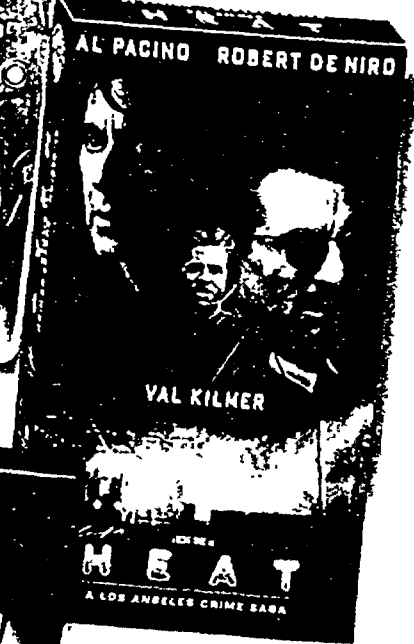
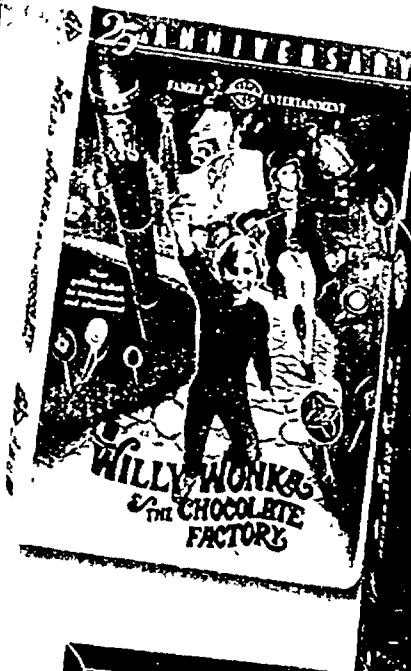

# SAVE ON MORE GREAT MOVIE FAVORITES

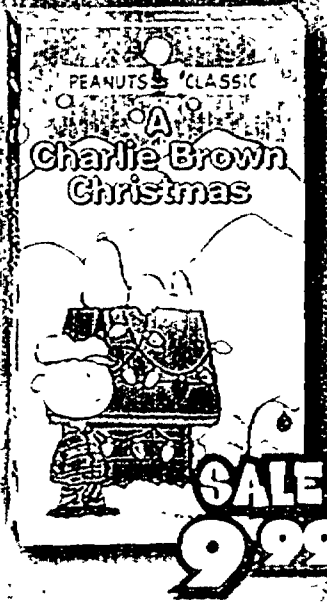

**SALE**  
**10.99**



**SALE**  
**7.99**



# \$3 OFF

Present this coupon to receive \$3 OFF the regular price of any 1997 Calendar in stock.

Limit one coupon per visit. Cannot be used in conjunction with any other coupon offer. No reproduction, copy or facsimile accepted. Sale items excluded. Offer expires December 4, 1996. Selection varies by store.



Markdown Code #25



**SUNCOAST**  
MOTION PICTURE COMPANY  
We Know Movies

# \$5 OFF

Present this coupon to receive \$5 OFF any movie regularly priced 14.95

Limit one coupon per visit. Cannot be used in conjunction with any other coupon offer. No reproduction, copy or facsimile accepted. Sale items excluded. Offer expires December 4, 1996.



Markdown Code #17



**SUNCOAST**  
MOTION PICTURE COMPANY  
We Know Movies

# \$4 OFF

Present this coupon to receive \$4 OFF the regular price of any T-shirt or Cap in stock.

(T-Shirts not carried in all stores. Selection varies by store.)  
Limit one coupon per visit. Cannot be used in conjunction with any other coupon offer. No reproduction, copy or facsimile accepted. Sale items excluded. Offer expires December 4, 1996.



Markdown Code #20



**SUNCOAST**  
MOTION PICTURE COMPANY  
We Know Movies

# \$10 OFF

Present this coupon to receive \$10 OFF the regular price of any gift set in stock, 49.98 or above.

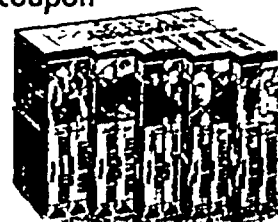

Limit one coupon per visit. Cannot be used in conjunction with any other coupon offer. No reproduction, copy or facsimile accepted. Sale items excluded. Offer expires December 4, 1996.

Markdown Code #21



**SUNCOAST**  
MOTION PICTURE COMPANY  
We Know Movies

# \$6 OFF

Present this coupon to receive \$6 OFF the regular price of any Laser Disc in stock.

Limit one coupon per visit. Cannot be used in conjunction with any other coupon offer. No reproduction, copy or facsimile accepted. Sale items excluded. Offer expires December 4, 1996.



Laser Discs not carried in all stores.

Markdown Code #27



**SUNCOAST**  
MOTION PICTURE COMPANY  
We Know Movies

# 99¢

Present this coupon to receive a Maxell VHS single video blank tape for only 99¢. Reg. 2.49 each

Limit one coupon per visit. Cannot be used in conjunction with any other coupon offer. No reproduction, copy or facsimile accepted. Offer expires December 4, 1996.



Markdown Code #24



**SUNCOAST**  
MOTION PICTURE COMPANY  
We Know Movies

# \$6 OFF

Present this coupon to receive \$6 OFF any movie regularly priced 19.95.

Limit one coupon per visit. Cannot be used in conjunction with any other coupon offer. No reproduction, copy or facsimile accepted. Sale items excluded. Offer expires December 4, 1996.



Markdown Code #29



**SUNCOAST**  
MOTION PICTURE COMPANY  
We Know Movies

# ONLY 16.95

with coupon  
Present this coupon to receive TOY STORY for only 16.95.

Limit one coupon per visit. Cannot be used in conjunction with any other coupon offer. No reproduction, copy or facsimile accepted. Offer expires December 4, 1996. © Disney Enterprises, Inc.



Markdown Code #93



**SUNCOAST**  
MOTION PICTURE COMPANY  
We Know Movies

Sale ends December 4. Not all items available in every store. SRP (suggested retail price) 50-5384-116

COLORADO: Colorado Springs (The Citadel); FLORIDA: Daytona Beach (Volusia Mall); GEORGIA: Atlanta (Cumberland Mall, North Lake Mall), Duluth (Gwinnett Place Mall), Dunwoody (Perimeter Mall), Kennesaw (Town Center at Cobb), Savannah (Oglethorpe Mall); ILLINOIS: Rockford (CherryVale Mall); INDIANA: Indianapolis (Castleton Square, Lafayette Square); KENTUCKY: Florence (Florence Mall); MICHIGAN: Dearborn (Fairlane Center), Grand Rapids (Woodland Mall), Harper Woods (Eastland Center), Novi (Twelve Oaks Mall), Roseville (Macomb Mall), Saginaw (Fashion Square Mall), Sterling Heights (Lakeside Mall), Taylor (Southland Mall), Waterford (Summit Place Mall); MINNESOTA: Blaine (Northtown Shopping Center), Bloomington (Mall of America), Burnsville (Burnsville Center), Edina (Southdale Shopping Center), Maplewood (Maplewood Mall), Minnetonka (Ridgedale Shopping Center), Roseville (Rosedale Shopping Center); NEW YORK: Buffalo (McKinley Mall), Fishkill (Dutchess Mall), Middletown (Galleria at Crystal Run), Poughkeepsie (Poughkeepsie Galleria), Williamsville (Eastern Hills Mall); NORTH CAROLINA: Pineville (Carolina Place); NORTH DAKOTA: Fargo (West Acres Shopping Center); OHIO: Cincinnati (Beechmont Mall, Eastgate Mall, Kenwood Town Centre, Northgate Mall, Tri-County Mall), Columbus (Eastland Mall), Toledo (Southwyck Shopping Center); OKLAHOMA: Tulsa (Woodland Hills Mall); PENNSYLVANIA: Camp Hill (Capital City Mall), Erie (Millcreek Mall), Harrisburg (Harrisburg East Mall); TENNESSEE: Antioch (Hickory Hollow), Franklin (Cool Springs Galleria), Goodlettsville (Rivergate Mall); UTAH: Orem (University Mall), Salt Lake City (Cottonwood Mall, Crossroads Plaza), W. Valley City (Valley Fair Mall); WISCONSIN: Appleton (Fox River Mall).

# SUNCOAST

MOTION PICTURE COMPANY  
We Know Movies

# What do kids really want for Christmas?

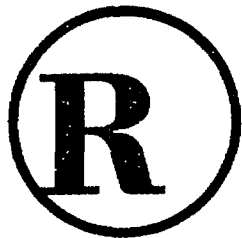
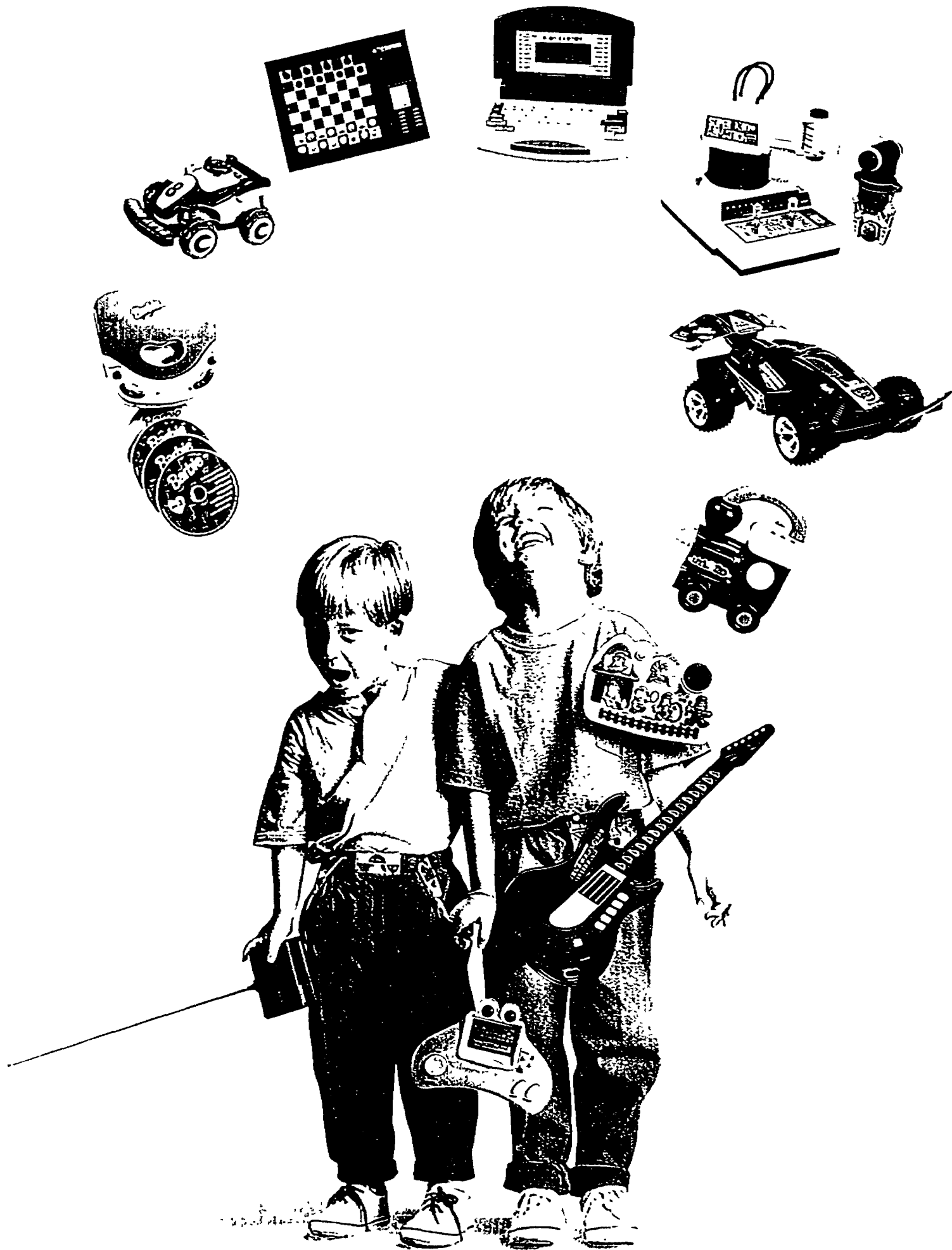

## RadioShack<sup>SM</sup>

You've got questions. We've got answers.®



## Radio-Control Fun!

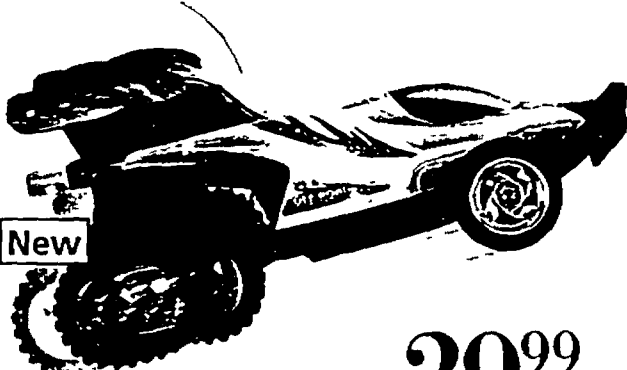

New

### The Sneaker

29<sup>99</sup>

Sneak past other racers! High and low gear speeds. A favorite gift with boys and girls. 27/49 MHz. 11" long. #60-4161SJ Add 9V and 8 "AA" batteries

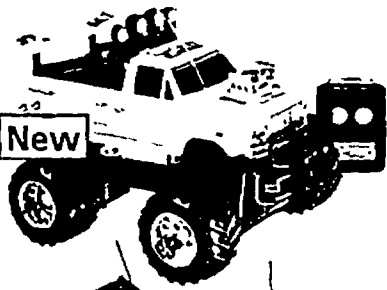

New

17<sup>99</sup>

**Wild Boss II.** Big & bad! Oversized tires. 49 MHz. 8 1/2" long. #60-4158SJ Add 9V and 6 "AA" batteries



12<sup>99</sup>

**Breeze Runner.** 4-wheel spring suspension. 27 MHz. 6 1/2" long. #60-4139SJ Add 9V and 2 "AA" batteries

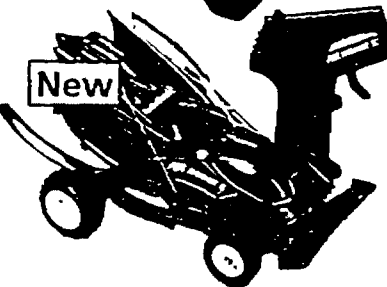

New

14<sup>99</sup>

**Air Rammer II.** Moving mouth and wings. Off-road tires. 49MHz. 7 1/2" long. #60-4157SJ Add 9V and 2 "AA" batteries

139<sup>99</sup> SAVE \$20

### Rock Runner/Car Crusher II

Two cars in one! Switch bodies for a whole new look. Independent spring suspension. Digital proportional steering. 27 MHz. 17 1/2" long. reg. \$59.99 #60-4173SJ Add 7.2V pack and 6 "AA" batteries

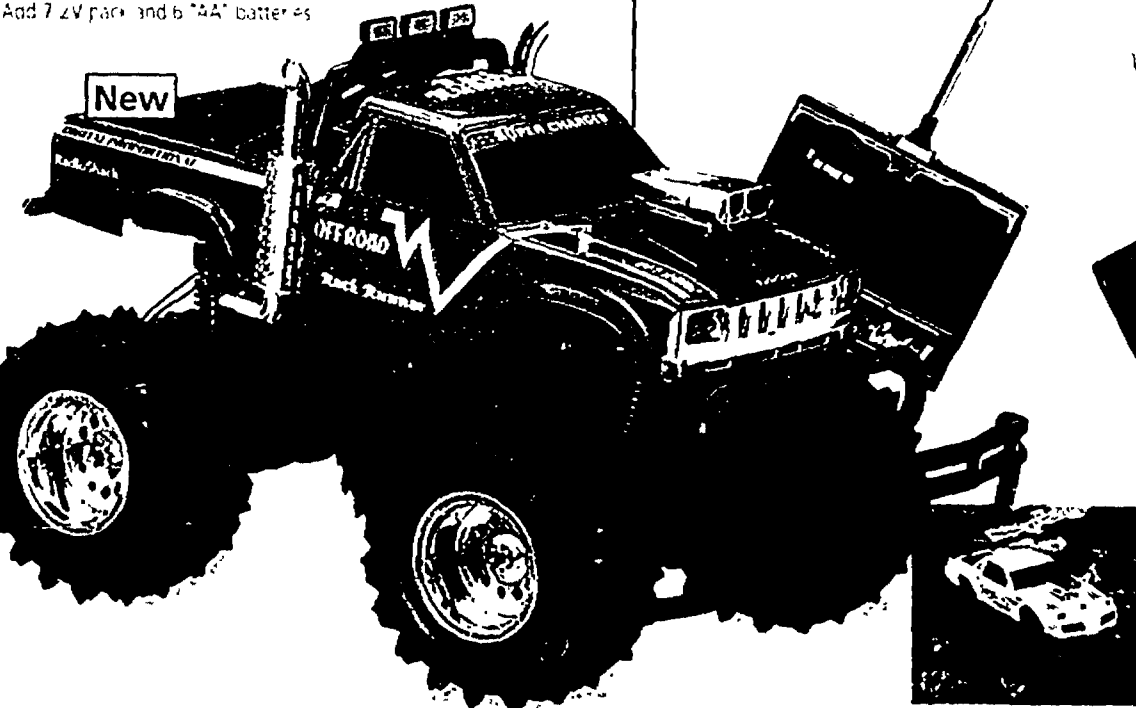

New

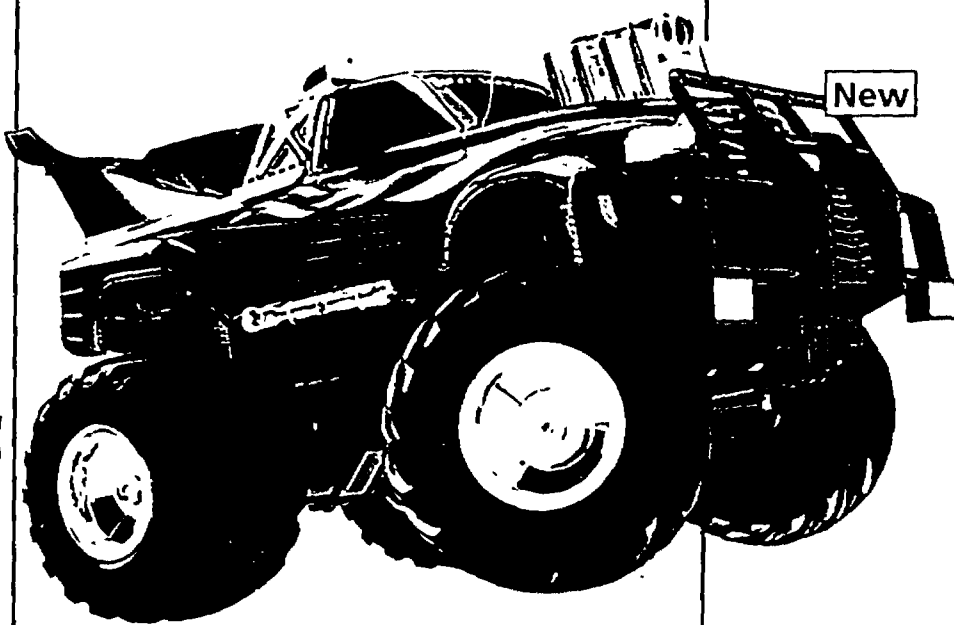

New

49<sup>99</sup>

### 16% OFF Hot Machine II

Oversized tires and 4-wheel drive power this monster truck. Choice of high or low gears. 27/49 MHz. 14" long. reg. \$59.99 #60-4169SJ Add 9V and 8 "AA" batteries



New

59<sup>99</sup>

**RadioShack Racing Team 18 Wheeler.** Remote-control trailer latch lets you hook up and drop off the trailer. Working read lights. 27/49 MHz. 26 1/2" long. #60-4166SJ Add 9V and 8 "AA" batteries

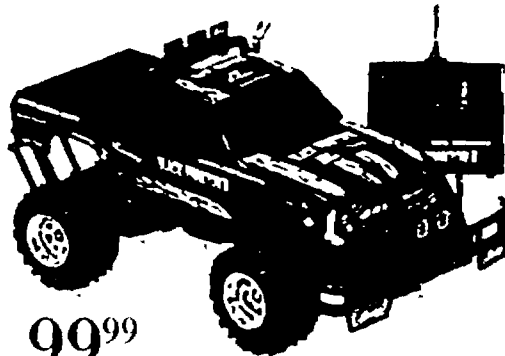

99<sup>99</sup>

**Black Phantom II.** Our fastest truck! Heavy-duty spring suspension. Digital proportional steering. 27 MHz. 17" long. #60-4155SJ Add 9.6V pack 6 "AA" batteries

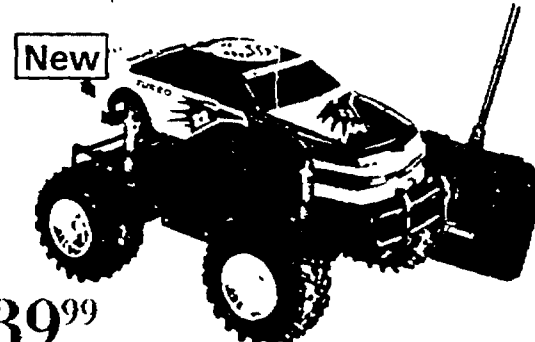

New

39<sup>99</sup>

**American Speedster II.** A classic with high/low speeds and turbo. 27/49 MHz. 14" long. #60-4163SJ Add 9V and 8 "AA" batteries

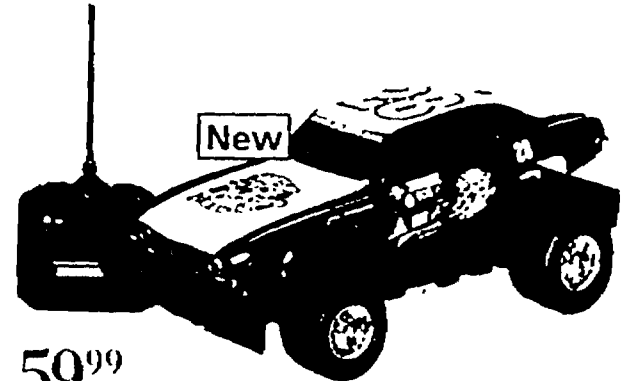

New

59<sup>99</sup>

**Street Sprinter.** Turbo charged for speed on the straightaways! Racing slicks help it blow away the competition. 27/49 MHz. 15 1/2" long. #60-4167SJ Add 9.6V pack and 2 "AA" batteries

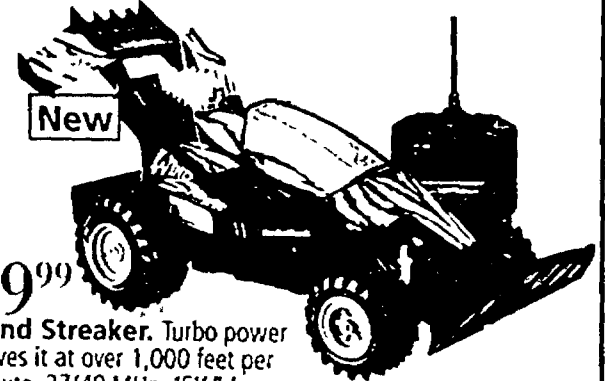

New

59<sup>99</sup>

**Wind Streaker.** Turbo power moves it at over 1,000 feet per minute. 27/49 MHz. 15 1/2" long. #60-4168SJ Add 9.6V pack and 9V battery

### Road Phantom

149<sup>99</sup>

Two powerful high-torque motors. 4-wheel drive and oversized tires. Digital-proportional steering. 27 MHz. 19 1/2" long. #60-4174SJ Add 7.2V pack 10 "AA" batteries

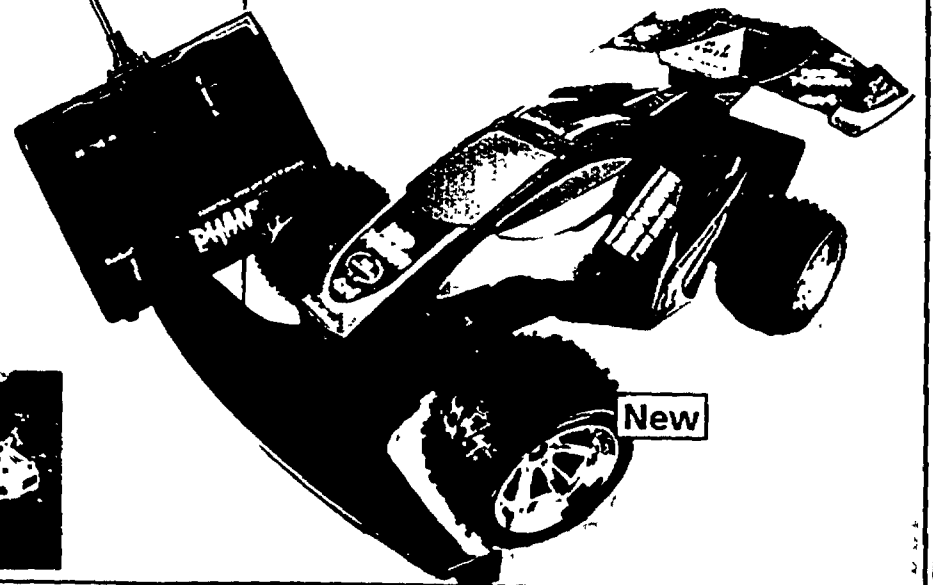

New



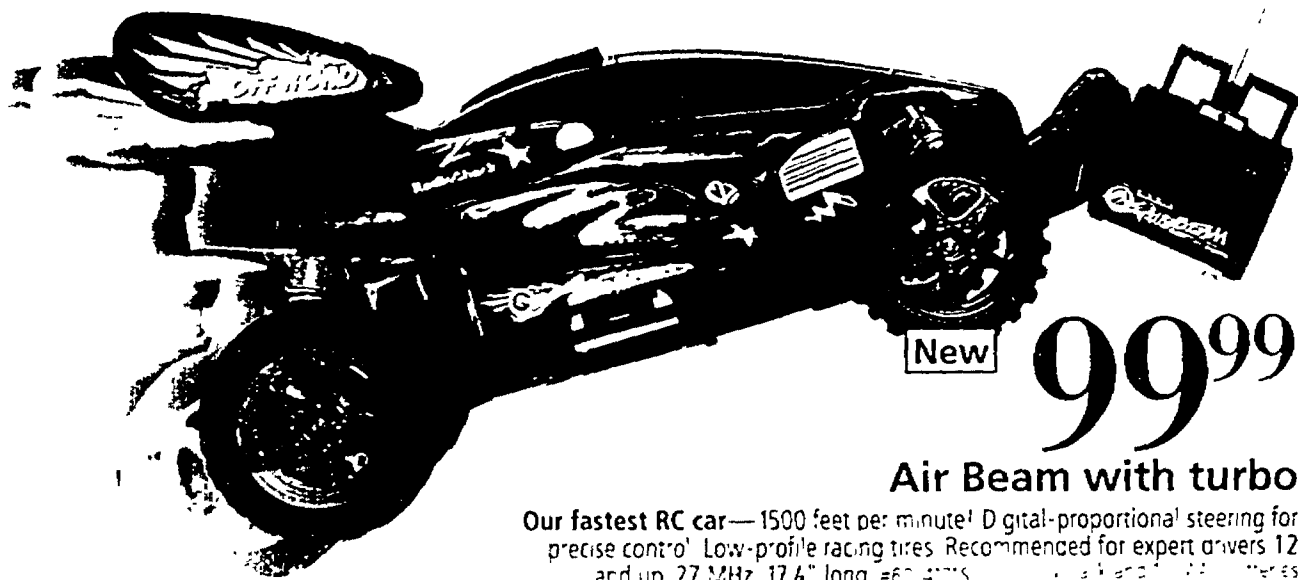

**New** **99<sup>99</sup>**

**Air Beam with turbo**

Our fastest RC car—1500 feet per minute! Digital-proportional steering for precise control! Low-profile racing tires. Recommended for expert drivers 12 and up. 27 MHz. 17 1/2" long. #60-4177S. Add 9V and 8 "AA" batteries.

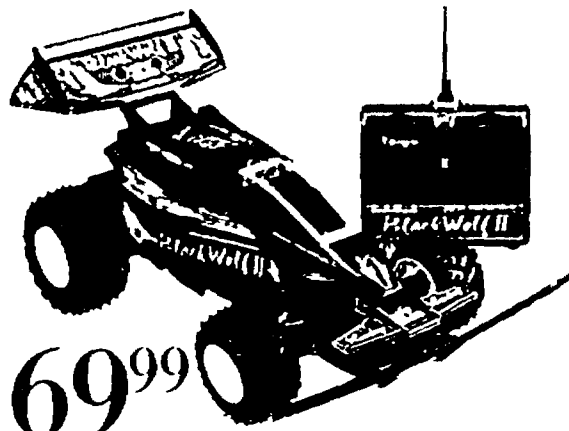

**69<sup>99</sup>**

**SAVE \$10 Black Wolf II**

Digital-proportional steering for precise control. Able to climb 45° inclines. 27 MHz. 15 1/2" long. reg. 79.99. #60-4154S. Add 9V and 8 "AA" batteries.



**New**

**39<sup>99</sup>**

**Evader with racing sounds**

"Stealth" styling for an awesome look. Racing jet sound with on/off control. Rear spring suspension and turbo power. 27/49 MHz. 13 1/2" long. #60-4162S. Add 9V and 8 "AA" batteries.

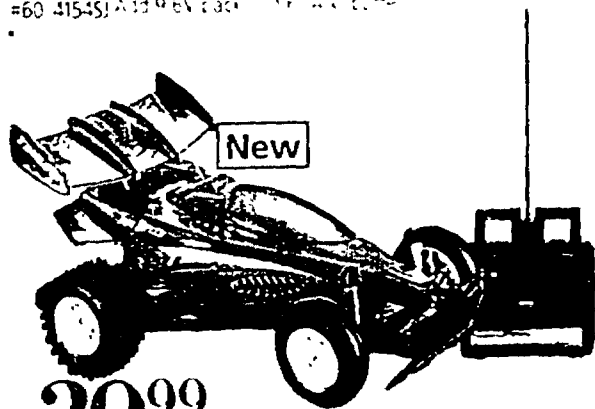

**New**

**39<sup>99</sup>**

**20% OFF**

**Flame Thrower**

Spring suspension. High and low speeds. 27/49 MHz. 14 1/2" long. reg. 49.99. #60-4165S. Add 9V and 8 "AA" batteries.

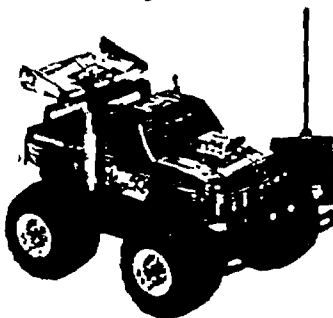

**49<sup>99</sup>**

**Thunder Fox II.**

4-wheel drive can climb 40° inclines. High/low gears. 27/49 MHz. 13" long. #60-4151S. Add 9V and 8 "AA" batteries.

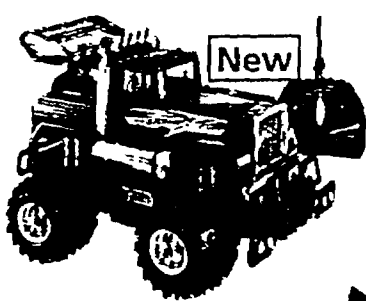

**New**

**49<sup>99</sup>**

**Wild Runner. 4-wheel steering for tight turns.**

Turbo power. 27/49 MHz. 12 1/2" long. #60-4170S. Add 9V and 8 "AA" batteries.

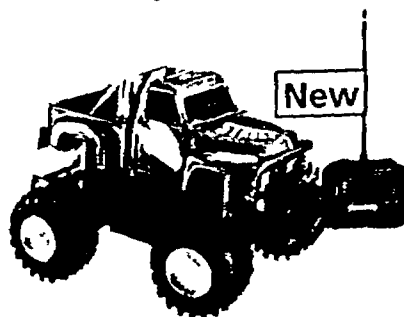

**New**

**39<sup>99</sup>**

**Street Comber II.**

High/low speeds. Turbo for extra power. 27/49 MHz. 14" long. #60-4164S. Add 9V and 8 "AA" batteries.



**29<sup>99</sup>**

**Rally Challenge.**

Rugged truck with off-road tires. 27/49 MHz. 10 1/2" long. #60-4145S. Add 9V and 6 "AA" batteries.



**New**

**21<sup>99</sup>**

**Sonic Thunder. Full-function mini racer with spring suspension.**

27/49 MHz. 9 1/2" long. #60-4159S. Add 9V and 4 "AA" batteries.

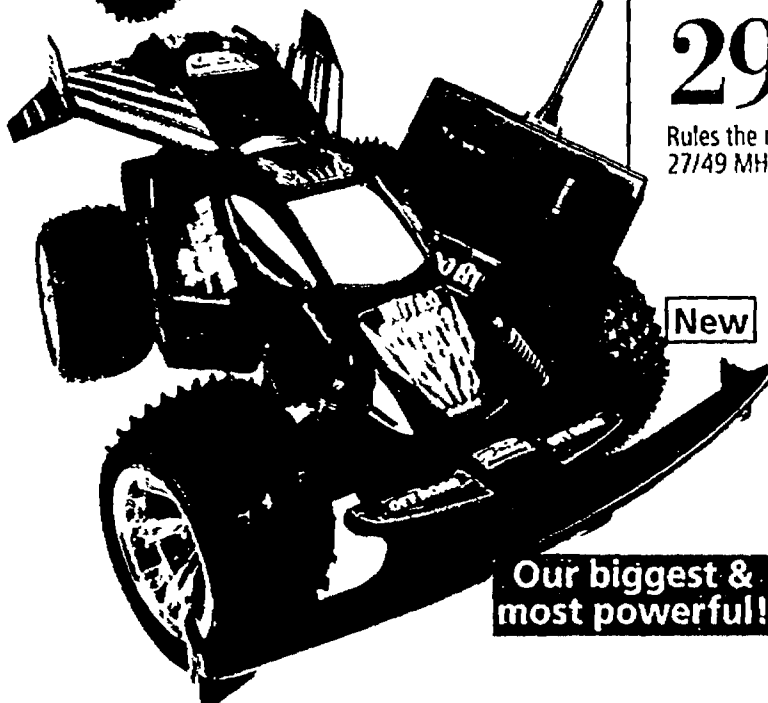

**New**

**179<sup>99</sup>**

**Nitro Burner**

One serious racing machine! Twin motors and 4-wheel drive deliver speed over any terrain. Precise digital-proportional steering and acceleration. Controller works up to 200 ft. away. Huge 1/8th scale—22" long! 27 MHz. #60-4175S. Add 7.2V pack & 6 "AA" batteries.

**Our biggest & most powerful!**

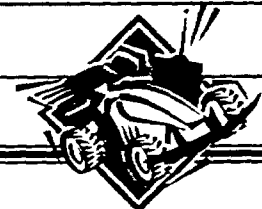

**GIVE RC CAR ACCESSORIES WE HELP KEEP THEM MOVING FAST**

Check our large selection of battery packs and chargers.



**AC fast charger for Ni-Cd packs.** Charge a standard 4.8V, 7.2V or 9.6V in one hour. #23-226S, 39.99



**DC fast charger.** Charges standard 7.2V Ni-Cd battery pack in just 20 minutes. #23-232S, 29.99

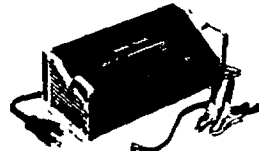

**AC/DC fast charger.** Charges standard 7.2 or 8.4V RC Ni-Cd battery pack in 20 minutes. #23-235S, 69.99



**9.6V Ni-Cd turbo pack.** 8 cells. #23-229S, 19.99  
**Hi-capacity 9.6V Ni-Cd pack.** #23-329S, 24.99  
**9.6V charger.** Charges std. in 14 hrs. #23-240S, 9.99



**4.8V turbo battery pack.** #23-245S, 10.99  
**4.8V charger.** Charges in 14-16 hours. #23-244S, 9.99

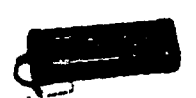

**7.2V racing pack.** Ultra-light. #23-230S, 19.99  
**7.2V Hi-capacity pack.** #23-330S, 24.99  
**7.2V charger.** Charges std. in 14 hrs. #23-241S, 9.99

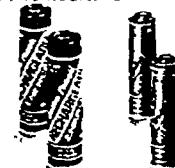

**Standard "AA" Ni-Cd.** #23-125S, 2-Pk./5.49  
**Hi-capacity "AA" Ni-Cd.** #23-149S, 2-Pk./6.99



**Ni-Cd charger.** For RC cars using "AA" Ni-Cd batteries. #23-249S, 6.99



**New**

**29<sup>99</sup>**

**Street Duel II**

Rules the road! Turbo power provides an extra burst of speed. 27/49 MHz. 12" long. #60-4160S. Add 9V and 8 "AA" batteries.



## Preschool Fun!

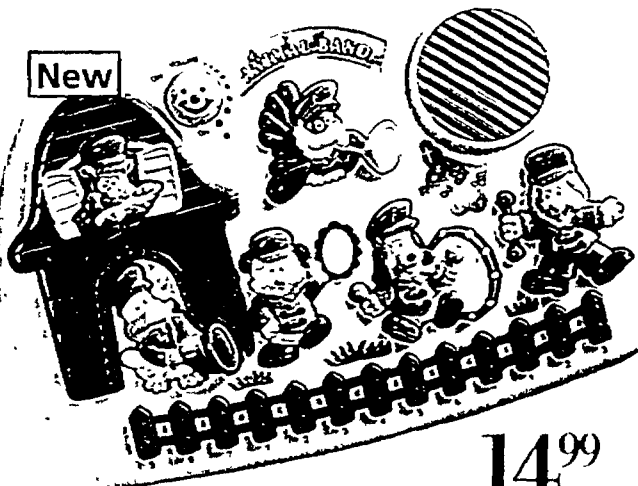

14<sup>99</sup>

### Animal Band

Press one of the animal band buttons and hear a marching tune or push fence buttons to make your own music. #60-2584SJ Add 3 "AA" batteries

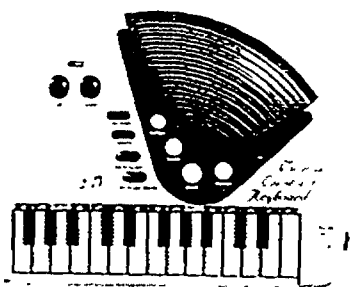

15<sup>99</sup>

Musical elephant keyboard. Kids can play their own melody or hear one of 15 preprogrammed songs with just one touch. #60-2571SJ Add 3 "AA" batteries

New

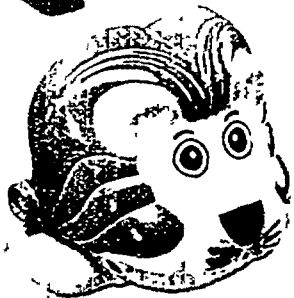

4<sup>99</sup>

A bright little friend in the night. When Light-Up Lion's jaws open, a beam of light turns on. #60-1151SJ Add 2 "C" batteries

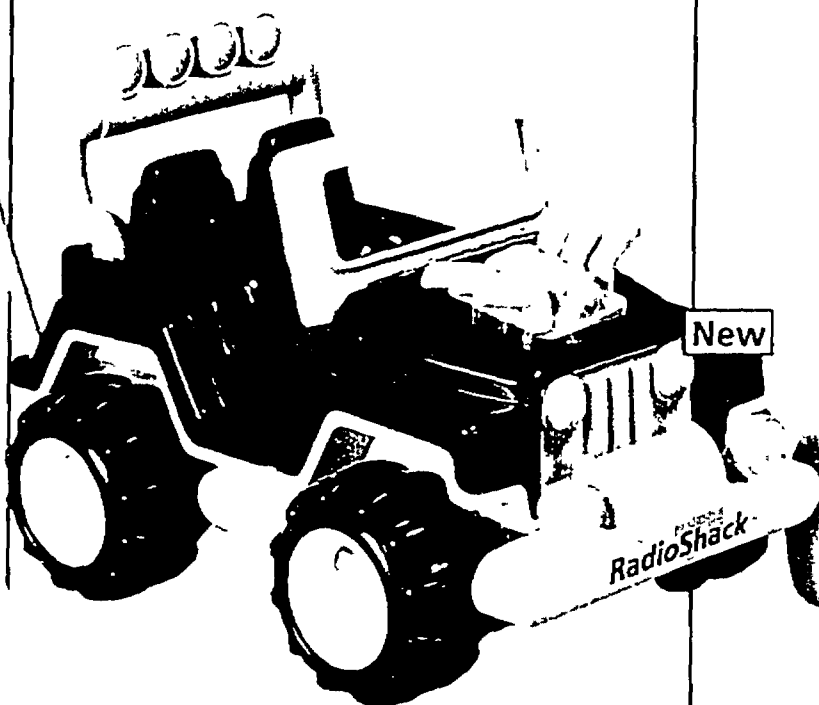

New

19<sup>99</sup>

### Radio-controlled fun buggy

Built-in driving sound and melody. Easy, 1-button controller for preschoolers. #60-2585SJ Add 2 "AA" batteries

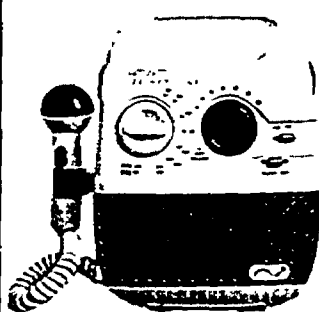
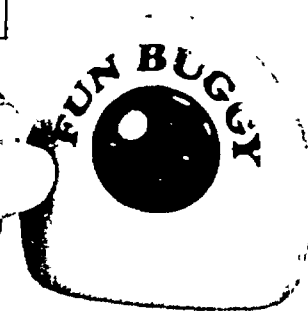

15<sup>99</sup>

AM/FM sing-along radio. Handheld microphone lets kids sing along with the music. #60-2516SJ Add 2 "C" batteries

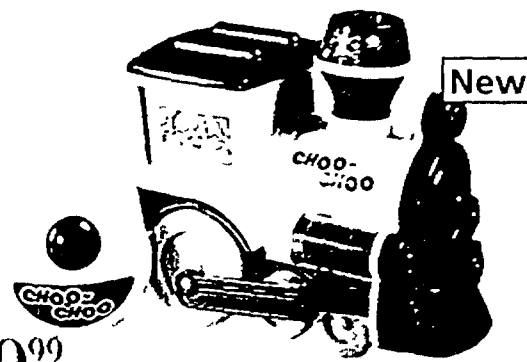

New

19<sup>99</sup>

Radio-control choo-choo. Turn it on and the motor starts and the lantern lights. Chugs, whistles, goes forward and so on. #60-2586SJ Add 3 "AA" batteries

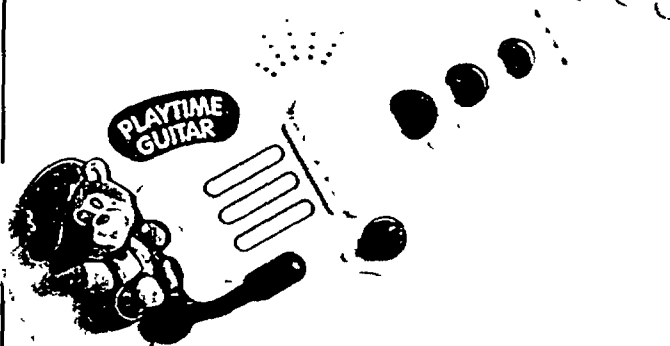

PLAYTIME GUITAR

12<sup>99</sup>

Playtime guitar. Hear one of eight built-in tunes or strum the strummer to play songs one note at a time. #60-2569SJ Add 3 "AA" batteries



New

9<sup>99</sup>

Li'l Loco. Colorful engine with flashing light and three train sounds. #60-2582SJ Add 2 "C" batteries

New



ROBIE

14<sup>99</sup>

RC Robie Robot. Easy to operate and fun to watch. Moves forward, reverses, turns. Head turns when he changes direction. #60-2583SJ Add 9V and 12 "AA" batteries

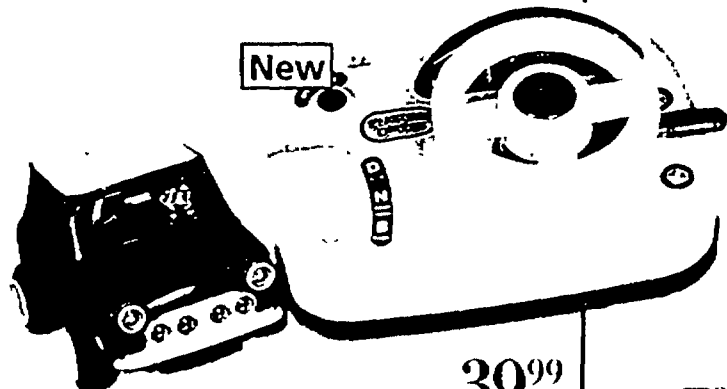

New

39<sup>99</sup>

Playtime driver with real-action remote. Fun for first-time drivers. Turn ignition key to start car, shift forward/stop/reverse, signal, use steering wheel to turn car—it even has a horn! #60-2587SJ Uses 8 "AA" batteries

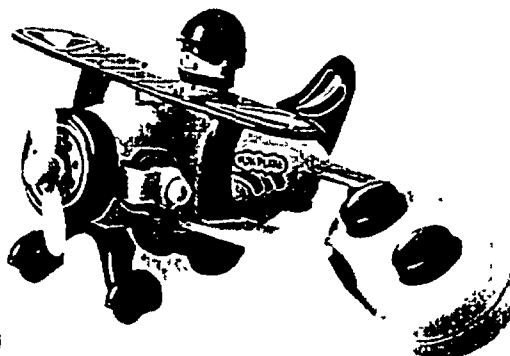

7<sup>99</sup>

Fun plane. Wire-controlled plane goes forward and turns in reverse. Safe spinning propeller. #60-2568SJ Add 2 "AA" batteries

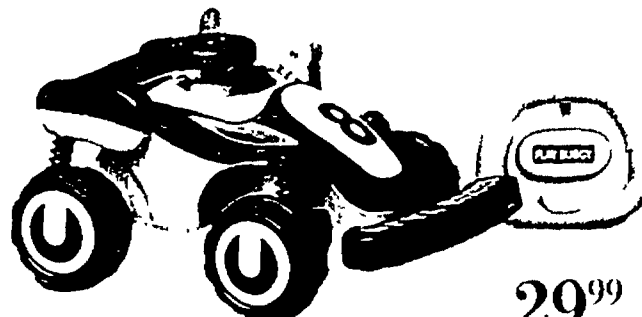

29<sup>99</sup>

RC play buggy with electronic horn. Turn the key and hear a real engine sound. Moves forward or reverse and turns. Soft bumper. #60-2572SJ Add 9V and 4 "AA" batteries



## Fun & Fascination!

# 15<sup>99</sup>

New

### Knock Man

Play knock-knock with the Knock Man. He doesn't just talk, he talks back! The ultimate "knock-knock" joke! #60-1155S  
Add 2 "AA" batteries



Hang him on your door

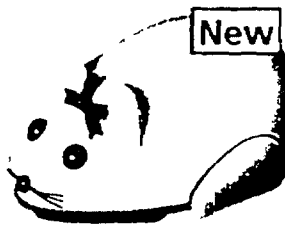

New

# 19<sup>99</sup>

**Squeakers phone.** Fun and compact! Actual working telephone for kid's room. Tone/pulse #43-862S



# 12<sup>99</sup>

Each  
**35% OFF Pettable AM/FM radios.** Kids love these snuggly musical pals reg. 19.99. Brown Bear #12-63S, Pekinese #12-64S  
Each uses 9V battery

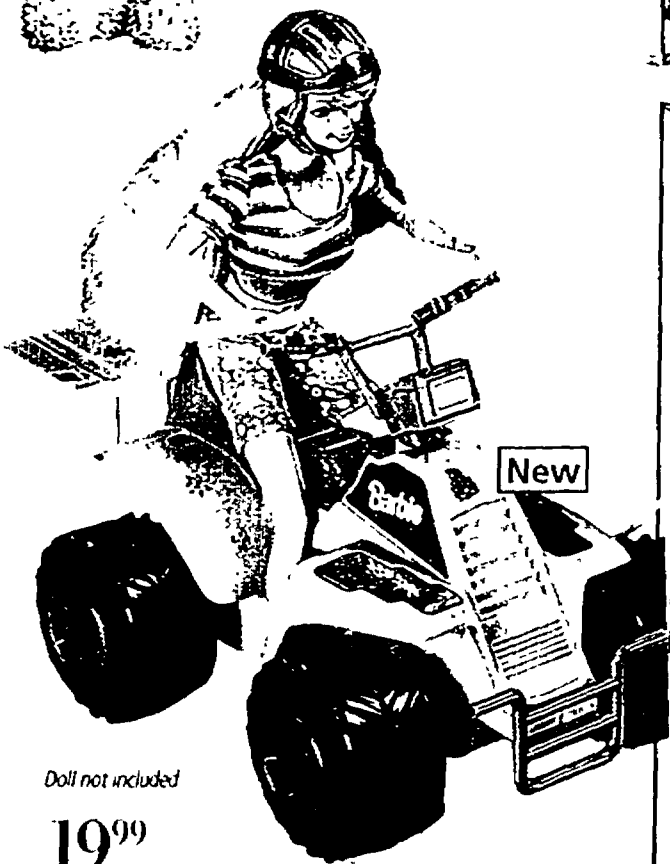

New

Doll not included

# 19<sup>99</sup>

**Sparkle Beach Barbie® Sun Rider.** Pops wheelies going forward and turns in reverse. Wire-controlled. #60-1157S Add 4 "C" batteries



# 7<sup>99</sup>

**Wire-controlled Street Shark.** Press a button for jaw crunching action! #60-1152S  
Add 2 "AA" batteries

New

# 14<sup>99</sup>

**Galactic Robot.** Walks forward and backward with his wire-controlled power pack. Movable arms. Removable parts. #60-1154S  
Add 2 "AA" batteries

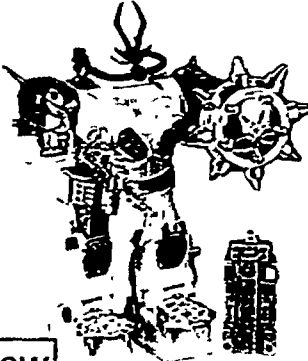

New

# 29<sup>99</sup>

**Super Armatron.** Robot arm moves up/down, left/right. Pincer opens and closes to pick up, move and release objects. Countdown meter for 2-player game. #60-2576S Add 2 "C" batteries

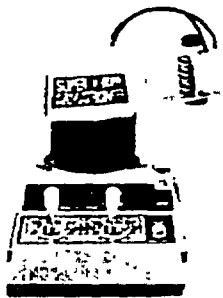

# 19<sup>99</sup>

**Talking Savings Bank.** Fun way to save. Tells amount of each deposit, total savings, and when savings goal has been reached. Play ATM card. #60-2574S Add 2 "AA" batteries



New

# 17<sup>99</sup>

**Barbie® talking pager.** Hear over 100 messages in Barbie's voice. Real pager sounds, 5 play modes. With designer belt and memo pad. #60-1160S Add 3 "AAA" batteries

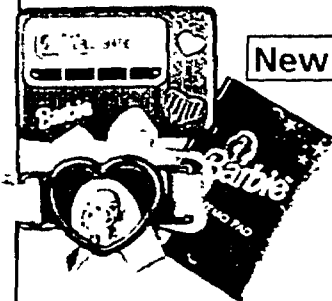

# 34<sup>99</sup>

New

**Barbie® talking phone & answerer.** Thousands of messages in Barbie's voice. Real phone sounds. #60-1161S  
Add 2 "AA" batteries

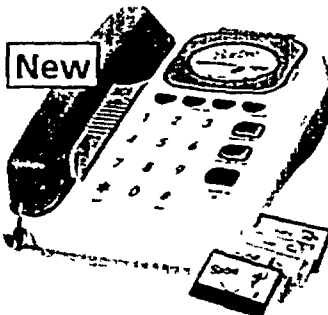

New

# 19<sup>99</sup>

**Barbie® "CD" player.** Listen to 32 melodies on four CD-like discs. With shoulder strap. Auto-power off. #60-1162S  
Add 3 "AA" batteries

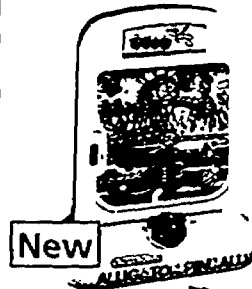
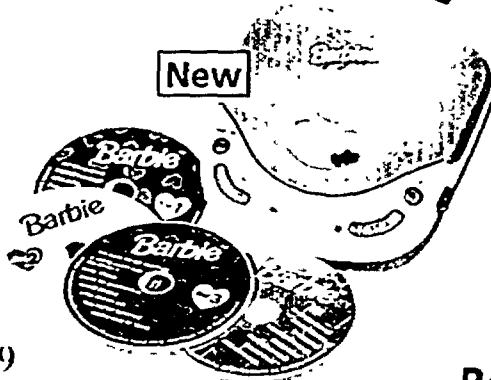

New

# 19<sup>99</sup>

**Alligator pinball.** Move the snapping gator under the falling pinballs—and gobble 'em up. #60-1156S  
Add 2 "C" batteries



New

# 24<sup>99</sup>

**Space Lion.** Build this mechanical marvel—over 80 pieces! Electric motor makes it move. #60-1158S  
Add 2 "AA" batteries

# 24<sup>99</sup>

**16% OFF Sing-along cassette recorder.** Use the microphone to sing along with tapes or record songs. reg. 29.99. #14-862S Add 4 "C" batteries or adapter AC #273-1562S DC #270-1560S

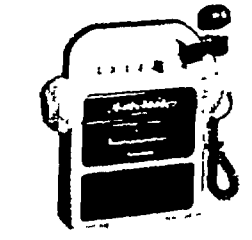

# 19<sup>99</sup>

**Stereo cassette player with headphones.** Big buttons are easy for little fingers to use. #14-864S Add 2 "AA" batteries



# 29<sup>99</sup>

**Air pinball.** All the excitement and sound of a real pinball machine. See how many points you can score! #60-2559S Add 2 "C" and 2 "D" batteries

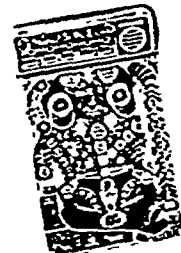

# 24<sup>99</sup>

**My Own Diary™ with funny faces.** Store your friends' names and numbers. Six funny-face combinations for names. Play Hangman or paper-scissors-stone. #65-824S



# 29<sup>99</sup>

**My Private Diary™.** Recall names/numbers instantly with Fast search. Create portraits of your friends and store them. Activity cards, vanity mirror. #65-836S



# 49<sup>99</sup>

**28% OFF Kid's diary with invisible beam.** Send a message to another diary. Draw silly faces. Two games—sea battle action and Tetris-style game. Memo pad. reg. 69.99 #65-725S

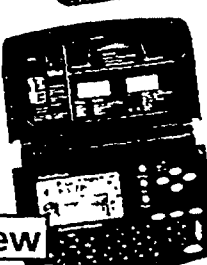

New

# 10<sup>99</sup>

### Robie the banker

He has a sweet tooth for tasty coins. Feed him a coin and he licks his chops and rolls his hungry eyes. #60-1153S Add 1 "AA" battery

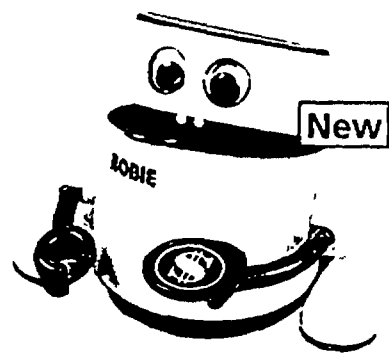

New



## RadioShack Gift Express™

The fast, easy way to send the most-wanted gifts for Christmas or any occasion!

It's quick, easy and affordable! Choose from thousands of great electronic gifts. Then, for a nominal charge, RadioShack Gift Express will put each gift in a gift box, enclose a personalized card and ship your gift anywhere in the U.S. via UPS® delivery service. To send a gift, visit your nearby RadioShack or call.

To order or for a store near you, call:

# 1-800-THE-SHACK™

Shipping and handling charges and taxes for state of delivery are applicable

# Learning That's Fun!



14<sup>99</sup>

**Show 'N Learn.** Fun way to learn colors, shapes, numbers, time, lots more. Plays music when correct answer is given. #60-2434S) Add 2 "AA" batteries



69<sup>99</sup>

**Talking Tutor.** He'll increase vocabulary and math skills. Over 23 activities. #60-2603S) Add 4 "AA" batteries

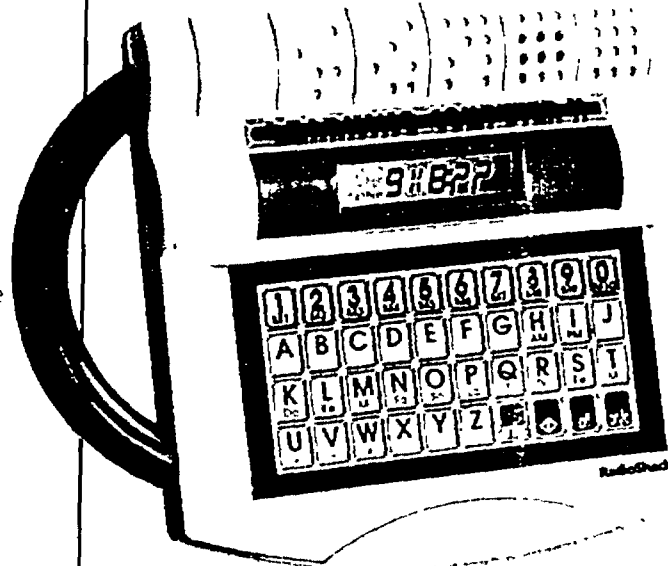

19<sup>99</sup>

**Learning Computer.** Portable playmate teaches 10 different lessons as kids play word games, practice math, identify pictures and more music. #60-2605S) Add 2 "AA" batteries

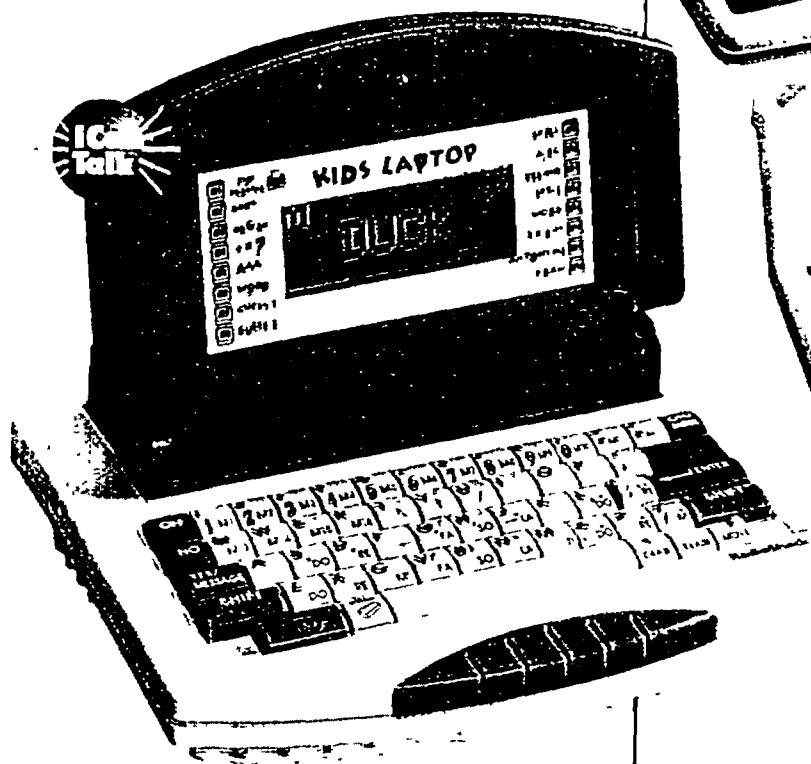

39<sup>99</sup>

**Talking Little Teacher.** 14 activities for up to 2 players in spelling, math, word games, music more. Friendly voice encourages kids. #60-2604S) Add 4 "AA" batteries

49<sup>99</sup>

**Kids laptop**

16 activities: spelling, typing, opposites, more. Animated pictures, voices and sounds. #60-2602S) Add 4 "AA" batteries

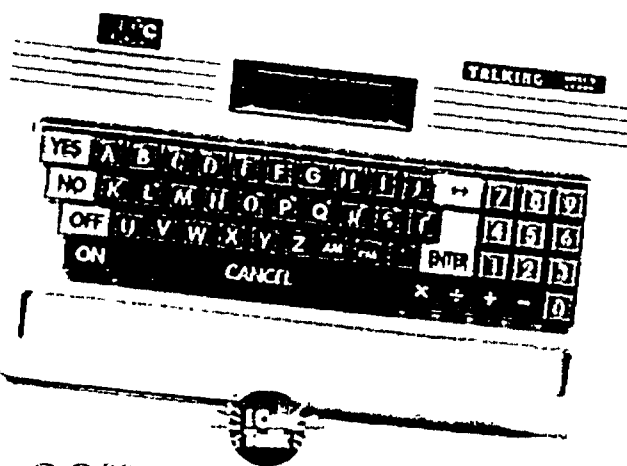

39<sup>99</sup>

**Spell & Learn Keyboard.** Talking keyboard helps kids learn to spell, calculate, play word games, more. #60-2437S) Add 4 "AA" batteries

## Science Fair®

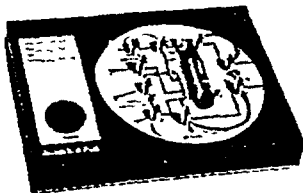

6<sup>99</sup>

**Crystal AM radio kit.** Build an AM radio that plays without batteries or AC. #28-177S)

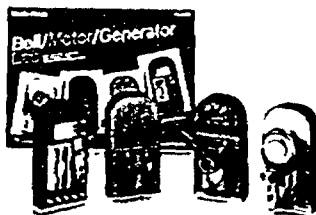

17<sup>99</sup>

**28% OFF Bell, motor & generator lab.** Learn about electricity. reg. 24.99. #28-145S) Add 2 "AA" batteries

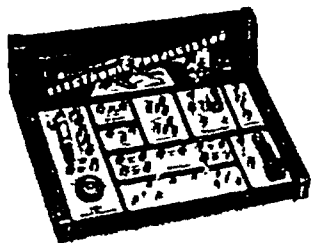

15<sup>99</sup>

**30-in-1 lab kit.** Learn electronics. No soldering! Build a radio, alarm, timer, more. #28-161S) Add 2 "AA" batteries

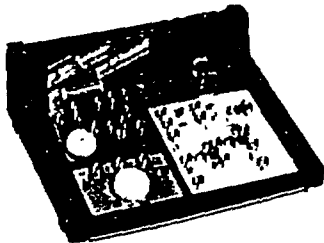

12<sup>99</sup>

**AM/VHF radio kit.** Hear AM, police, air, weather bands. #28-163S) Add 9V battery

**AM/FM kit.** #28-175S), 12.99. Add 2 "AA" batteries

**AM/Shortwave radio kit.** #28-176S), 12.99. Add 9V battery

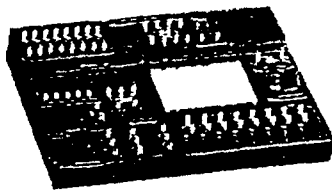

59<sup>99</sup>

**300-in-1 lab kit.** Plug components into the breadboard to create sound effects, electronic games, lots more. #28-270S) Add 6 "AA" batteries

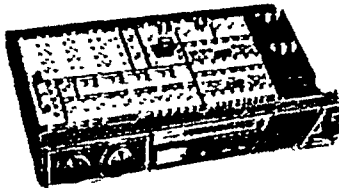

39<sup>99</sup>

**20% OFF 200-in-1 lab kit.** Teaches computer basics. On-board control panel with analog meter. reg. 49.99. #28-265S) Add 6 "AA" batteries

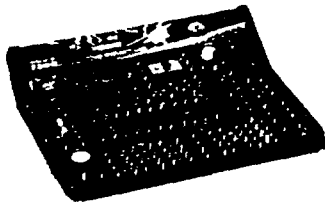

24<sup>99</sup>

**16% OFF 130-in-1 lab kit.** Build an AM broadcast station, strobe lights, more. reg. 29.99. #28-259S) Add 6 "AA" batteries

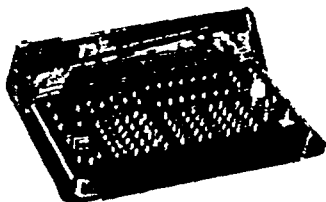

24<sup>99</sup>

**75-in-1 lab kit.** Make a strobe light, metronome, sound-level meter, more. #28-267S) Add 4 "AA" batteries

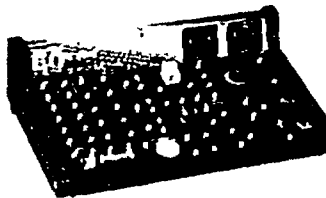

14<sup>99</sup>

**25% OFF 60-in-1 lab kit.** Learn basics of electronics, magnetism and physics. reg. 19.99. #28-261S) Add 4 "AA" batteries

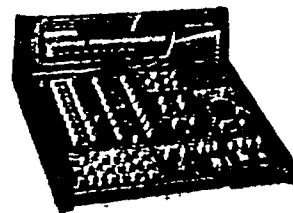

24<sup>99</sup>

**Digital voice recording and sound lab.** 50 projects include talking alarm, touch-control switch, robot voice. #28-264S) Add 3 "AA" batteries

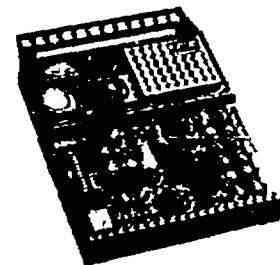

24<sup>99</sup>

**HALF PRICE! "Building Block" lab kit.** No wires—just snap the blocks in place to create 60 fun projects. reg. 49.99. #28-147S) Add 2 "AA" batteries

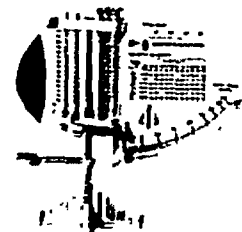

12<sup>99</sup>

**13% OFF 6-in-1 weather station.** Learn about weather by measuring wind, amount of rainfall, humidity, temperature, wind chill. reg. 14.99. #63-868S)

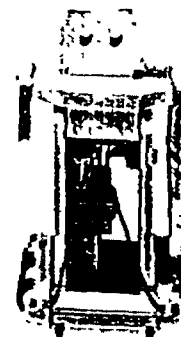

9<sup>99</sup>

**Walking robot kit.** Build your own self-propelled robot! Easy to assemble. #28-001S) Add 2 "AA" batteries



## Skill & Imagination!

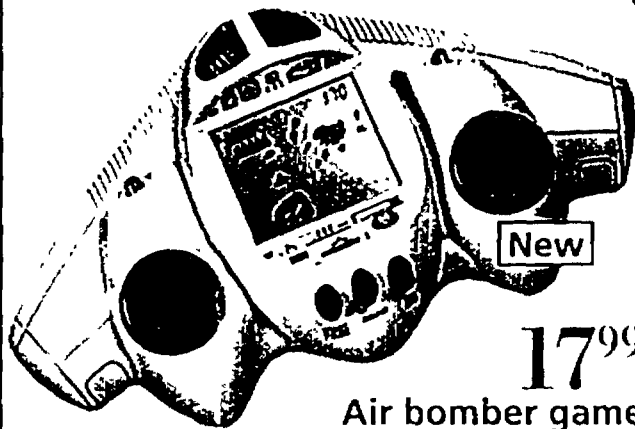

New

17<sup>99</sup>

### Air bomber game

Feel the high flying excitement with realistic battle sound effects, flashing lights and vibrating action. #60-2664S1. Add 2 "AAA" batteries.



New

19<sup>99</sup>

**Portable Pac-Man.** It's eat or be eaten with this handheld version of the arcade classic. #60-2665S1. Includes 2 "AAA" batteries.

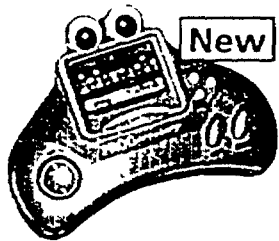

New

14<sup>99</sup>

**Frog Crossing game.** Can you help the frog hop across the road and river to get home safely? #60-2662S1. Add 2 "AAA" batteries.

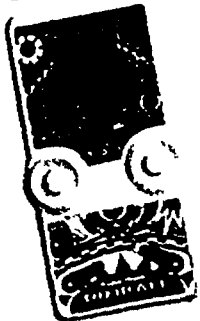

19<sup>99</sup>

**Handheld LCD pinball.** 8 exciting skill levels and patterns. Vibrating action, flipper controls. #60-2481S1. Add 2 "AAA" batteries.

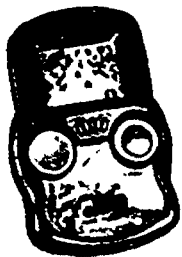

14<sup>99</sup>

**Sonic car racing.** Drive a turbo "monster truck" in this exciting LCD game. #60-2661S1. Add 2 "AAA" batteries.



14<sup>99</sup>

**Helicopter attack.** Fly an attack chopper and defeat the enemy. 3 skill levels. #60-2460S1. Add 2 "AA" batteries.

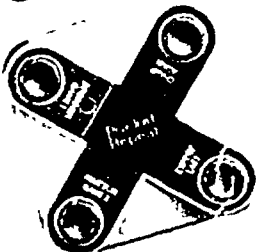

8<sup>99</sup>

**25% OFF Pocket repeat.** A real memory tester! Repeat the color or sound pattern to win. reg. 11.99. #60-2482S1. Add 9V battery.

## Music Makers!

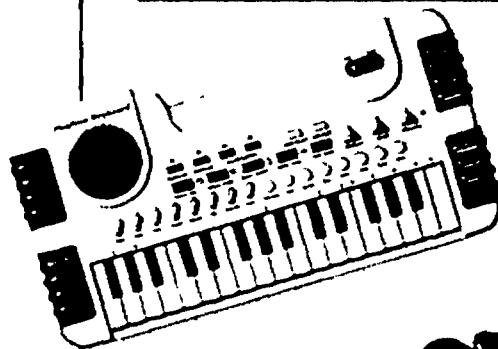

19<sup>99</sup>

**Playtime keyboard.** Make music on the 32 mini keys, or record and playback your performance! #60-2567S1. Add 4 "AA" batteries.

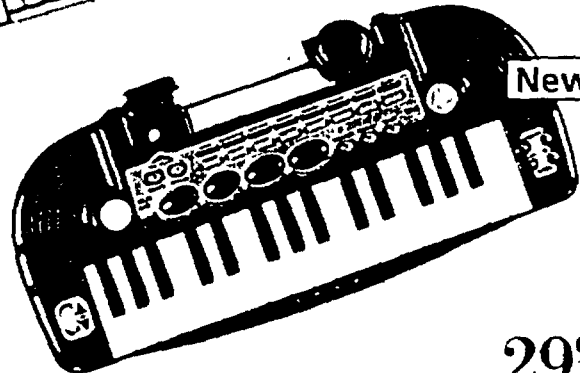

New

29<sup>99</sup>

**Sing-along keyboard with microphone.** 32 lighted keys with follow-along teaching function. Mic folds up and becomes a carry handle. #60-2580S1. Add 4 "AA" batteries.

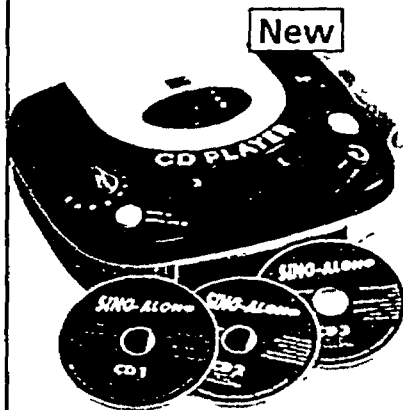

New

15<sup>99</sup>

**Toy "CD" player with sing-along microphone.** Includes 3 "CDs" with 31 songs to play or sing along to. #60-2579S1. Add 2 "AA" batteries.

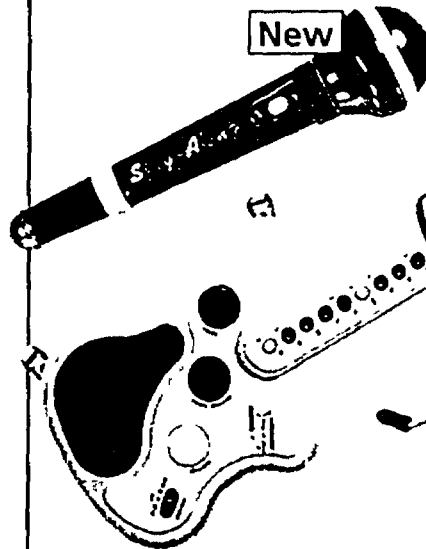

New

7<sup>99</sup>

**Wireless microphone.** Transmits kids' voices over your FM radio. #60-2578S1. Add 2 "AA" batteries.

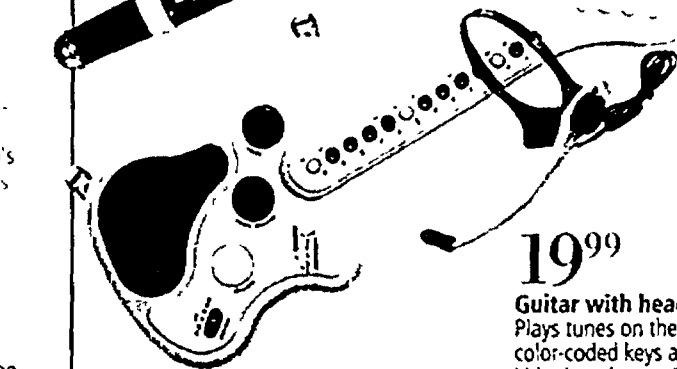

19<sup>99</sup>

**Guitar with headset.** Plays tunes on the thirteen color-coded keys and lets kids sing along. #60-2563S1. Add 4 "AA" batteries.

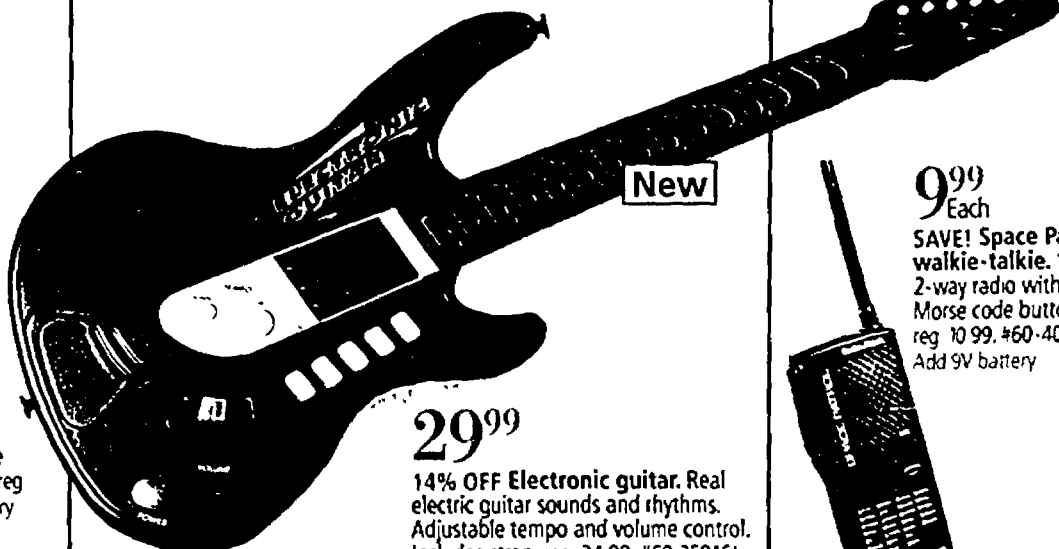

New

29<sup>99</sup>

**14% OFF Electronic guitar.** Real electric guitar sounds and rhythms. Adjustable tempo and volume control. Includes strap. reg. 34.99. #60-2581S1. Add 4 "AA" batteries.

## Walkie-Talkies

24<sup>99</sup>  
Pair

New

**Headset walkie-talkies.** Voice-activated—no buttons to push! #60-4008S1. Each requires 2 "AAA" batteries.



24<sup>99</sup>  
Pair

### Telephone-style walkie-talkies

Two frequencies let you talk and listen at the same time. #60-4007S1. Each requires 2 "AA" batteries.

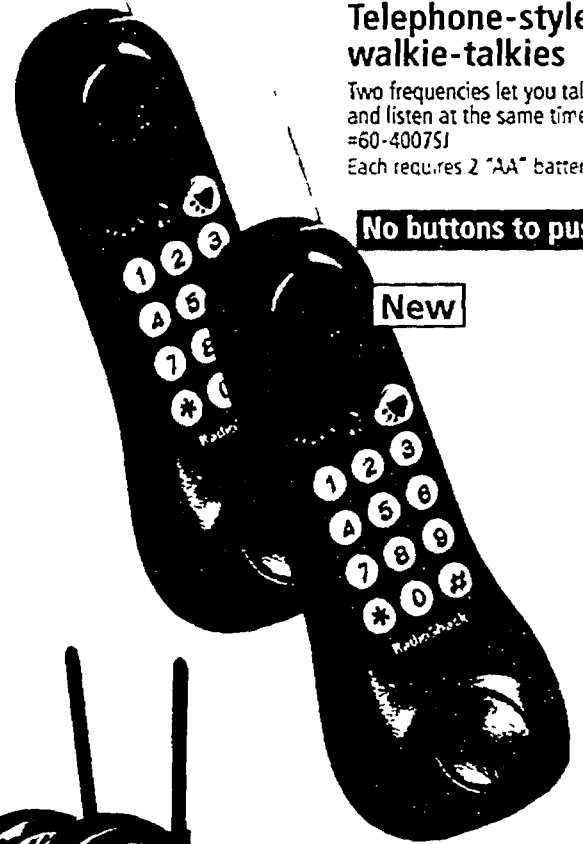

No buttons to push!

New

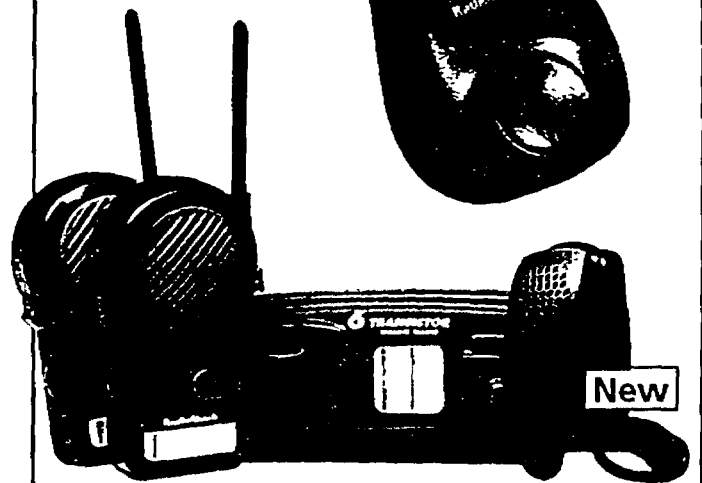

New

29<sup>99</sup>  
Set

**Walkie-talkies with base station.** All 3 units can communicate at one time. #60-4009S1. Add 3 9V batteries.



9<sup>99</sup>  
Each

**SAVE! Space Patrol walkie-talkie.** Slim 2-way radio with Morse code button. reg. 10.99. #60-4024S1. Add 9V battery.



19<sup>99</sup>  
Pair

**13% OFF Micro-size walkie-talkies.** 49MHz handsets are sleek and easy to carry. reg. 22.99. #60-4025S1. Each requires 1 9V battery.

Prices apply at participating RadioShack stores and dealers. Items not available at a participating store can be special-ordered (subject to availability) at the advertised price. A participating store will offer a comparable value if the product is sold out. Independent RadioShack dealers and franchisees may not be participating in this ad or stock or special-order every item advertised. See inside for RadioShack policy on advertised items and for obtaining warranty information. Prices good through 12/24/96.



## Games for All Ages!

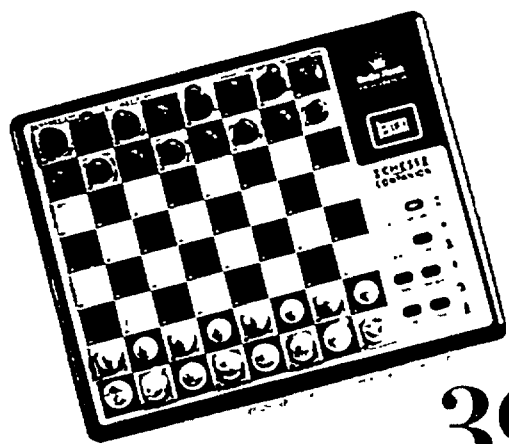

**39<sup>99</sup>**

### Chess Companion

Its 64 playing levels let you adjust computer strength to match your style and skill. Also lets you progress as you learn. #60-24395J Add 2 "AAA" batteries.



Fold up case stores pieces

**49<sup>99</sup>**

### Portable Chess

Take it anywhere. Pause feature—turn it off and continue later. 64 levels, Position Verification and Rule Enforcement. #60-24445J Add 2 "AAA" batteries.

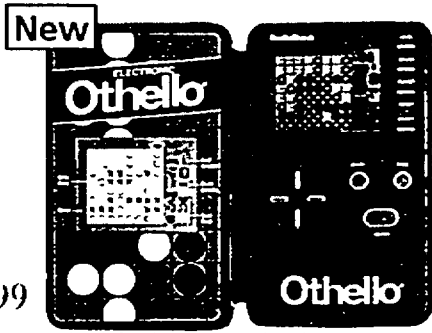

**19<sup>99</sup>**

Othello® strategy game. Challenge the computer in this classic game. Finish with more colored chips showing and you win. 3 levels. #60-26605J Includes batteries.

**19<sup>99</sup>**

### Coin sorter bank

Motorized bank quickly sorts, counts and stacks rolls of coins so they're ready to wrap. #60-24965J Add 2 "C" batteries.

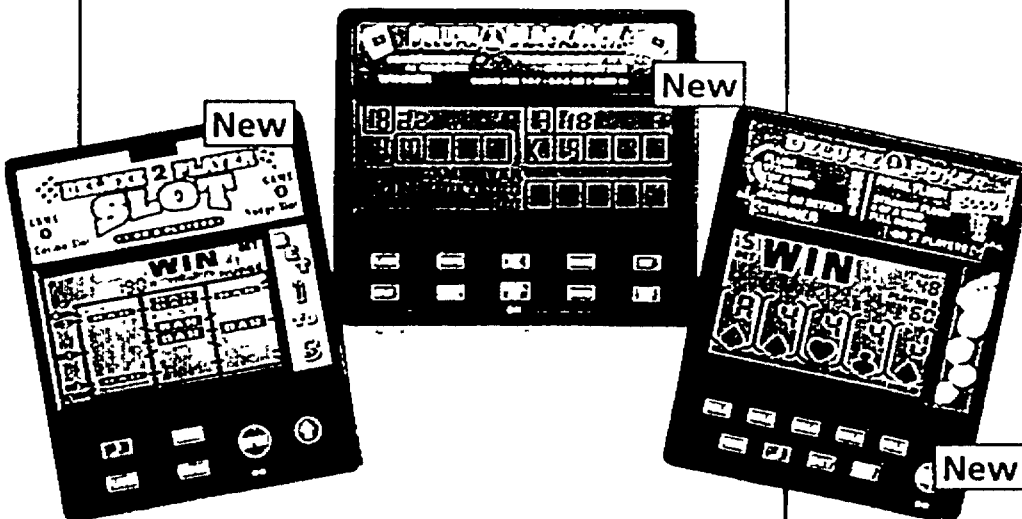
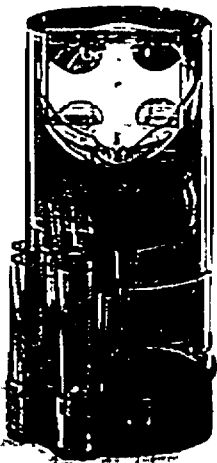

**15<sup>99</sup> YOUR CHOICE!**

2-player slot machine. Endless hours of fun! Two different slot games. #60-26555J Add 2 "AAA" batteries.

2-player blackjack 21 game. Play anywhere. 52 card deck, auto score-keeper. #60-26545J Add 2 "AAA" batteries.

2-player poker. All the fun of real poker! Hold, fold, draw, bet, pass. #60-26565J Add 2 "AAA" batteries.

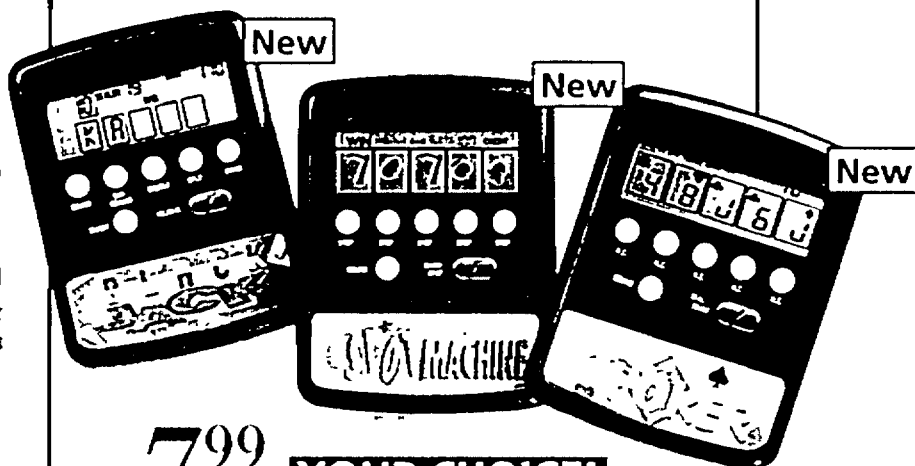

**14<sup>99</sup>**

### Gin Rummy

Try to "gin" or "knock" before the computer beats you. Three skill levels. Last game memory. #60-26585J Includes batteries.

**7<sup>99</sup>**

### YOUR CHOICE!

**Blackjack.** Casino action! Surrender, double down, split, stand. #60-26515J Add 2 "AAA" batteries.

**Slot machine.** Can you beat this one-armed bandit? Sound effects. #60-26525J Add 2 "AAA" batteries.

**Draw poker.** Play anywhere. Easy-to-read display. Hold, cancel and draw. #60-26535J Add 2 "AAA" batteries.

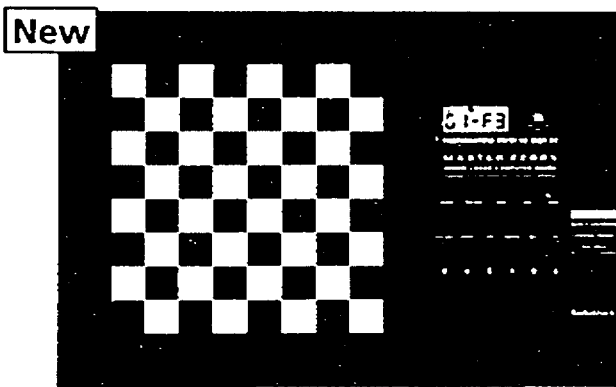

**99<sup>99</sup>**

### Master 2200X Chess

Endorsed by '95 world chess champ Garry Kasparov! 64 skill levels. Tournament and individual options. Programmable display emulates ticking of a chess clock for realistic play. #60-22135J Add 6 "C" batteries.

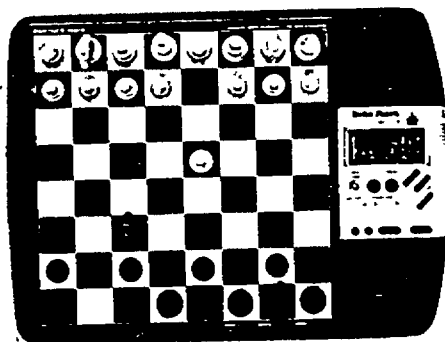

**69<sup>99</sup>**

### Chess Partner

64 skill levels, including fun and puzzle levels. Practice escape moves with Set-Up. Take back up to six moves. #60-24285J Add 4 "AA" batteries or AC adapter #273-14555J



**15<sup>99</sup>**

**Handheld Billiards.** Large display for up-close action. 3 different games, exciting sound effects. #60-26575J Add 2 "AAA" batteries.

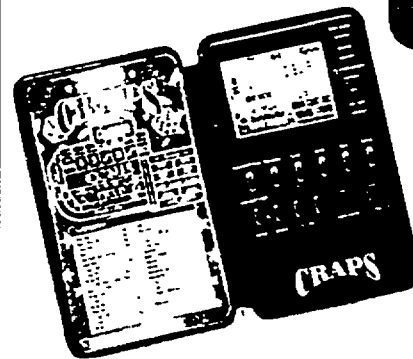

**14<sup>99</sup>**

### Craps game.

Action-packed fun for one or two players. Keeps track of your winnings. Music and flashing display. #60-24485J Includes batteries.

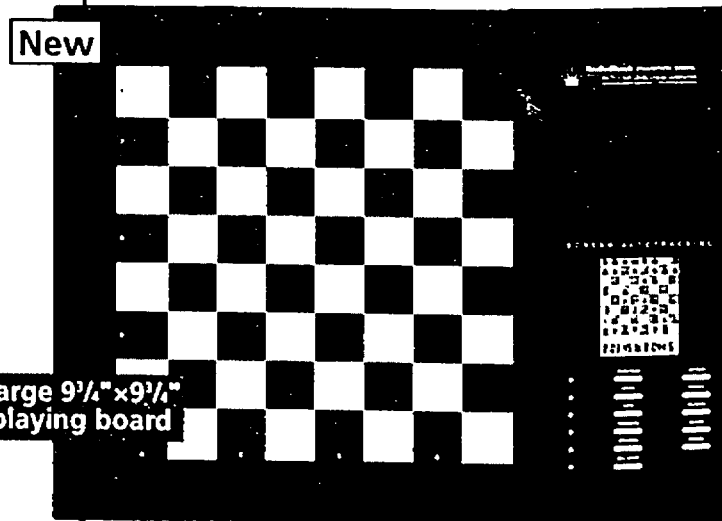

Large 9 1/4" x 9 1/4" playing board

**149<sup>99</sup> SAVE \$20**

### Champion 2250 Chess computer

Our best! 64 levels—challenging for advanced players or beginners. Play tournament, blitz, more. Flexible play styles. Full display shows movement info. reg. 169.99. #60-22155J Add 6 "C" batteries.

**BUTLER**

Take with **Special**

# GIFTS FOR THE HOME

Great gift ideas for a warm and beautiful home



### Valet Stand

Handsome design on our valet stand made from selected solid woods. Tawney finish. 18 1/2"W, 14"D, 42"H  
Sugg. Retail \$99.95

**Sale \$39.95**

Cherry Finish  
Sugg. Retail \$614.95

**Sale \$399.95**

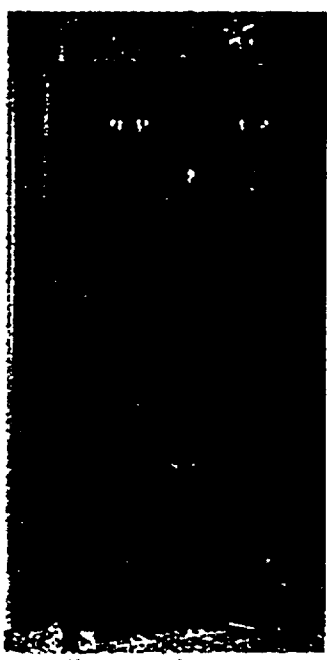

### Secretary

Pine with warm Chestnut finish. Features drop lid with leatherette writing surface, lighted interior, storage compartments. 23"W, 11"D, 52"H  
Sugg. Retail \$589.95

**Sale \$399.95**

Also available in Washed White or Chestnut/Forest Green finish.

### Cheval Mirror

Made from selected solid woods. Adjustable tilt mechanism. Float glass mirror. Cherry finish. Also available in Oak finish. 19"W, 16 1/2"D, 60 1/2"H  
Sugg. Retail \$249.95

**Sale \$169.95**



### Game Table

Made from selected solid woods and veneers. Lift-off top w/felt card table on flipside. Includes removable game board for Checkers/Chess on one side, Backgammon on the other side. Comes w/game pieces, dice and dice cups. Storage for all playing pieces under game board. Two (2) pull-out beverage trays. Cherry or Oak finish. 28"W, 22 1/2"D, 30"H  
Sugg. Retail \$489.95

**Sale \$329.95**

*Design Service Available*

# CLASSIC INTERIORS FURNITURE

20292 MIDDLEBELT, LIVONIA  
(South of 8 Mile)

**(810) 474-6900**

# For any Room...

Beautiful, wonderfully crafted furniture

## Bench

Selected solid woods with hobnail upholstery. Cherry finish. Also available in Tawney finish.  
46 3/4"W, 18"D, 30 1/2"H  
Sugg. Retail \$374.95

Sale **\$249.95**

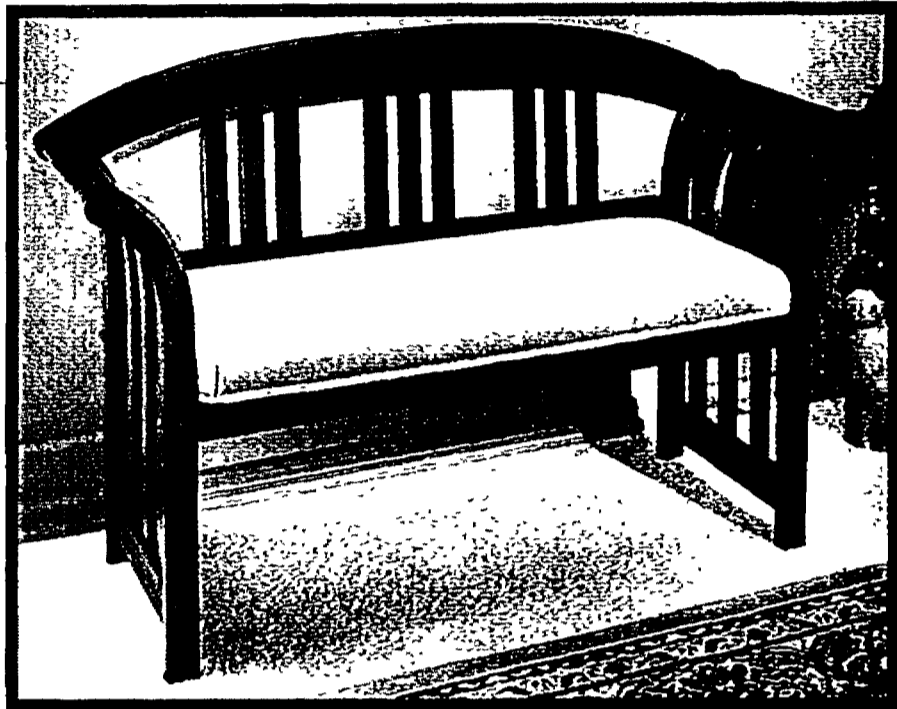

## Wall Curio

Made from selected solid woods. Glass door. Mirror back. Two shelves. Curved glass sides. Available in Cherry or Fruitwood finish. 20 1/2"W, 5 1/2"D, 26"H  
Sugg. Retail \$249.95

Sale **\$169.95**

## Blanket Stand

Made from selected solid woods. Horizontal rails are used to hang quilts, comforters and blankets. Brass-plated rosettes. Cherry finish. Also available in Tawney, Washed White, or Forest Green finish. 28 1/2"W, 15 1/2"D, 36 1/2"H  
Sugg. Retail \$149.95

Sale **\$89.95**

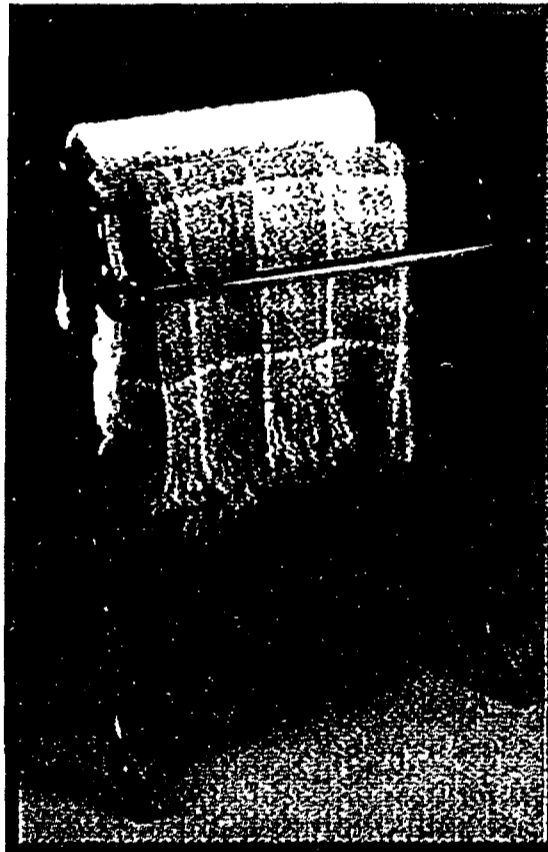

## Console Table and Mirror

Selected solid woods. Four-way matched veneer top and cross grain border. Three drawers w/brass-plated metal hardware. Float glass mirror. Cherry or Oak finish.  
26"W, 12"D, 30"H

### Console

Sugg. Retail \$379.95

Sale **\$249.95**

### Mirror

Sugg. Retail \$164.95

Sale **\$109.95**



## Magazine Table Floor Lamp

Selected solid woods. Magazine storage compartments. Beveled glass top. Harvest finish.  
19 1/2"W, 16"D, 54"H  
Sugg. Retail \$349.95

Sale **\$229.95**

Also available in Harvest/Forest Green finish.

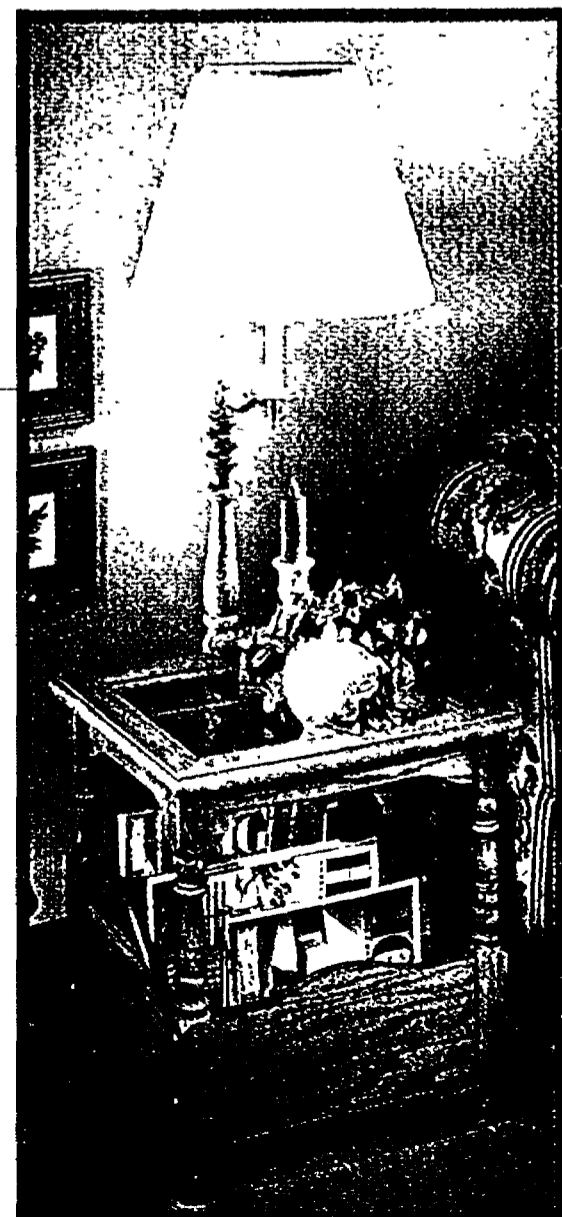

# BUTLER

While every effort was made to anticipate demand, we cannot guarantee availability of every item in this circular. Some items may require easy assembly.



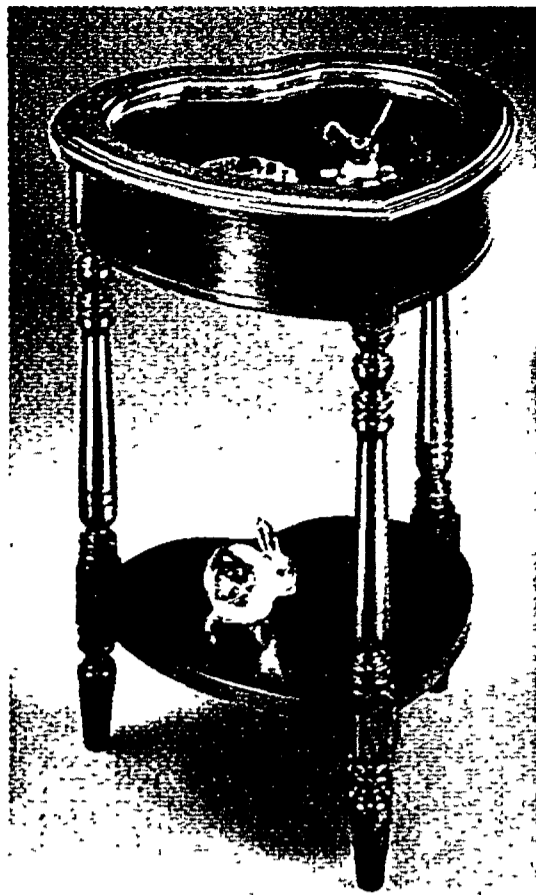

### Heart-Shaped Curio Table

Made from selected solid woods and choice veneers. Curio table has hinged top for access to display area. Lower shelf for added display. Cherry, Oak or Light Cherry finish.  
 15½"W, 15½"D, 21½"H  
 Sugg. Retail \$224.95

Sale **\$149.95**

Also available in Light Cherry/Forest Green finish.



### Costumer

Made from solid pine. Turned center coat pegs. Four (4) brass-plated top double hooks. Umbrella holder with base cups. Country Home finish.  
 20"W, 20"D, 67½"H  
 Sugg. Retail \$239.95

Sale **\$159.95**

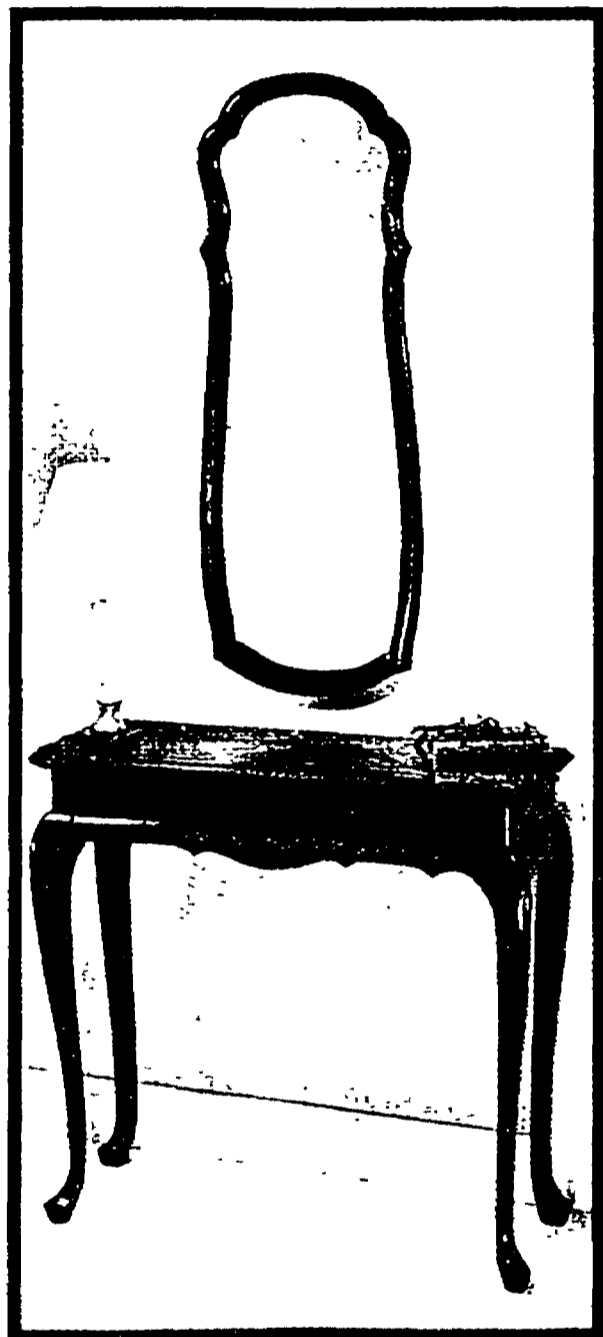

### Console Table and Mirror

Selected solid woods and choice veneers. Four-way matched veneer top and cross grain border. Float glass mirror. Cherry or Oak finish.  
 34½"W, 12"D, 30"H

#### Console

Sugg. Retail \$304.95

Sale **\$199.95**

#### Mirror

Sugg. Retail \$164.95

Sale **\$109.95**

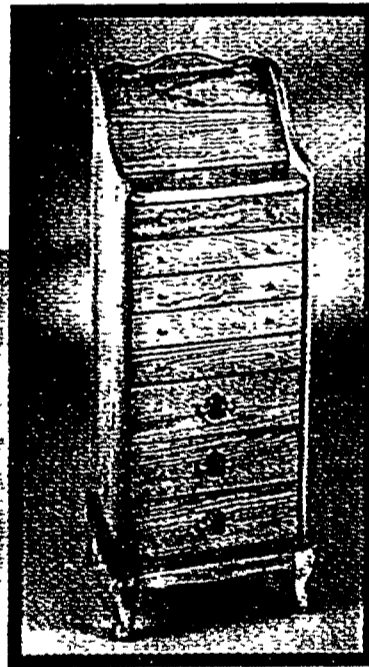

### Jewelry/Lingerie Chest

Made from selected solid woods and choice veneers. Lift up top with mirror. Five lined drawers, divided for jewelry storage. One pull-up tray for hanging jewelry. Available in Cherry or Oak finish.  
 17½"W, 15"D, 44"H  
 Sugg. Retail \$624.95

Sale **\$399.95**

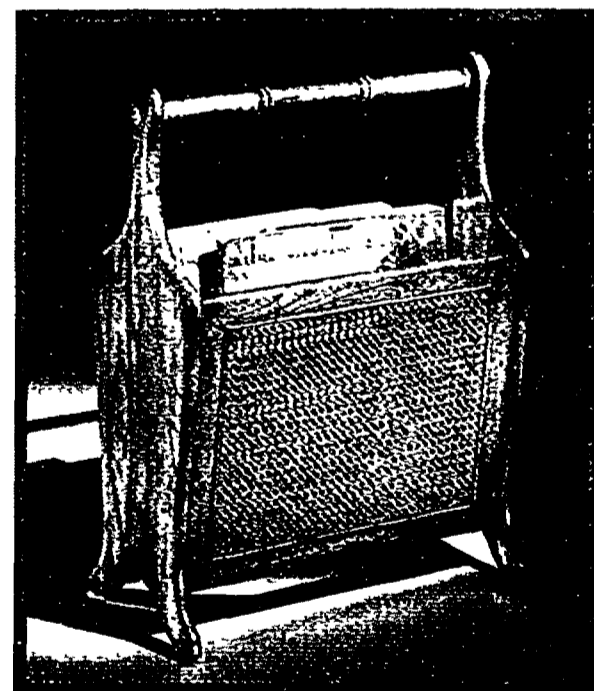

### Magazine Basket

Selected solid woods. Cane sides. Brass rosette trim. Olde English finish.  
 17"W, 11"D, 18½"H  
 Sugg. Retail \$139.95

Sale **\$89.95**



Take with **Special**



### Valet Stand

Handsome design on our valet stand made from selected solid woods. Tawney finish. 18 $\frac{1}{2}$ "W, 14"D, 42"H  
Sugg. Retail \$99.95

Sale **\$39.95**



### Console Table and Mirror

Made from selected solid woods. Matched veneer top with cross grain border. Working drawer. Float glass mirror. Cherry finish. 31 $\frac{1}{2}$ "W, 13"D, 30 $\frac{1}{2}$ "H

#### Console

Sugg. Retail \$354.95

Sale **\$249.95**

#### Mirror

Sugg. Retail \$179.95

Sale **\$119.95**

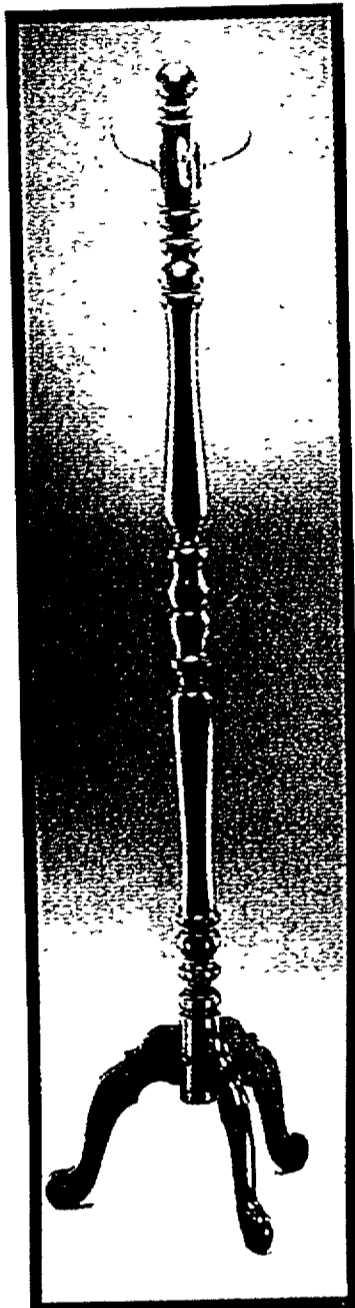

### Costumer

Made from selected solid woods. Five antique brass-plated hooks for hanging coats, hats, and umbrellas. Cherry or Tawney finish. Sugg. Retail \$149.95

Sale **\$99.95**



### Storage Bench

Versatile yet attractive storage bench made from solid pine. Hinged seat for access to storage area. Country Home finish. 42"W, 17 $\frac{1}{2}$ "D, 31"H  
Sugg. Retail \$469.95

Sale **\$299.95**



### Magazine Table Floor Lamp

Made from selected solid woods and choice veneers. Magazine storage compartment. Lamp has 3-way switch. Oak finish. 15"W, 22"D, 53"H  
Sugg. Retail \$299.95

Sale **\$199.95**

Also available as Magazine Table.

Design Service Available

# CLASSIC INTERIORS FURNITURE

20292 MIDDLEBELT, LIVONIA (South of 8 Mile)

**(810) 474-6900**

Mon., Thurs., Fri.  
9:30-9:00;  
Tues., Wed., Sat.  
9:30-5:30;  
Open Sunday 1-5

VISIT OUR IN-STORE CLEARANCE CENTER



All discounts are off manufacturers' suggested retail prices. All previous sales excluded. Offer not valid in conjunction with any other promotional discount.

0647251

# Introducing

# THREE TOPS!

Where can you get a medium, three-topping pizza for a song? Why, Hungry Howie's of course! Right now, Hungry Howie's is offering a medium, flavored-crust pizza, loaded with your choice of

three tasty toppings, all for just \$6.99. Or two medium, three topping pizzas, only \$10.99

So if you enjoy great value and great tasting pizza, Hungry Howie's Three Tops will be music to your ears.

**\$6.99**  
**ONE MEDIUM**

**\$10.99**  
**TWO MEDIUM**

Available at participating locations. Delivery extra. Plus tax.

## TOPPINGS:

- Pepperoni
- Mushroom • Ham
- Ground Beef • Onion
- Italian Sausage • Bacon
- Green Pepper • Anchovies
- Black Olives • Mild Peppers



# Hungry Howie's®

The Official Pizza of  
**pine knob**  
music theatre

OVER 350 LOCATIONS NATIONWIDE!

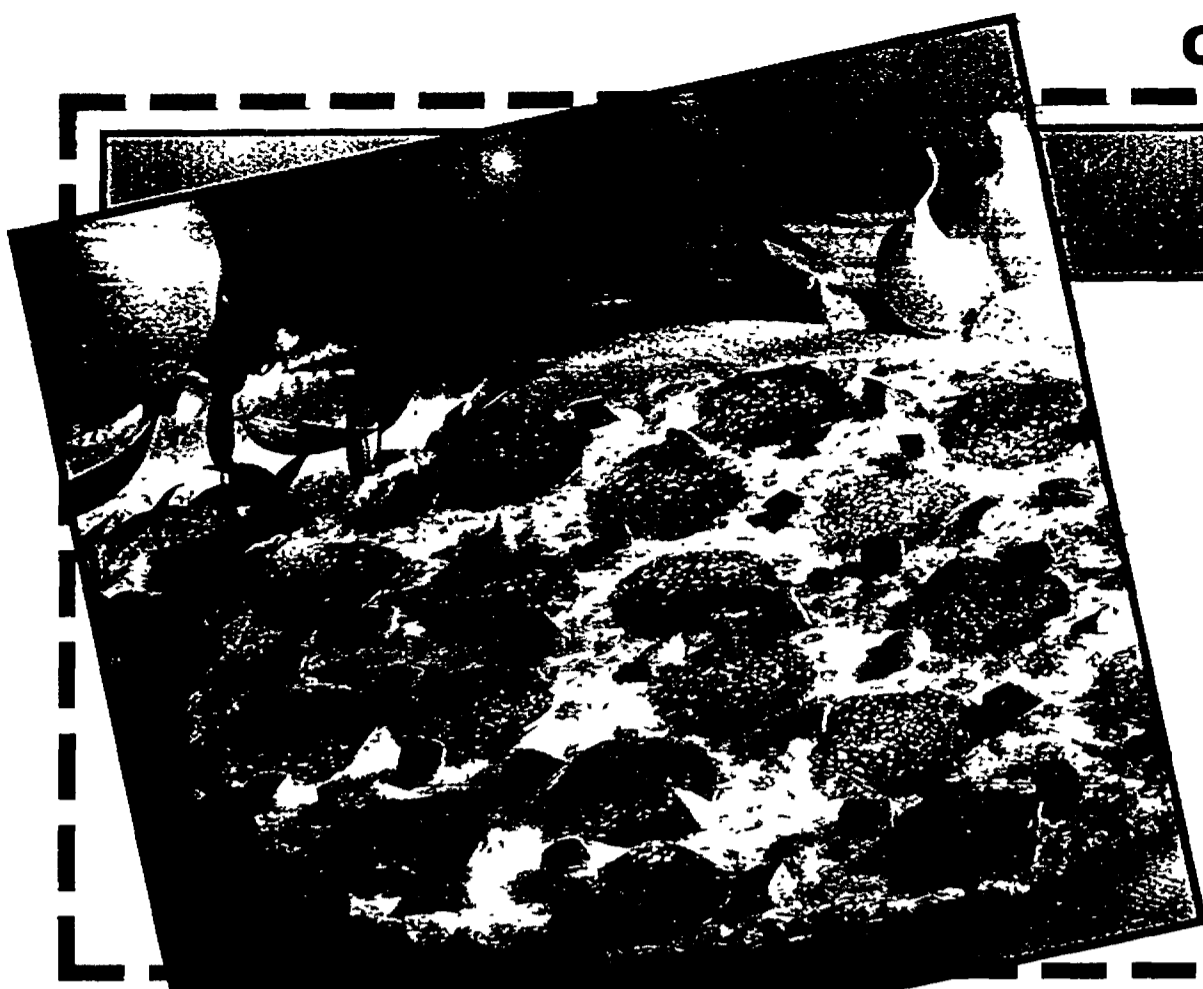

## NEW "CRISP-N-THIN"

An Ultra-Thin Crisp and Crunchy, like a Cracker! You still get all the toppings and all the flavor, but with a little added crunch!

Available in 12" only - Mix & Match with Original Crust

.....4.99 • Toppings 99¢

**Original Crust - FREE on any Pizza!**



### HOWIE EXPRESS

One Large  
Pepperoni Pizza

**\$5.99**

Plus Tax • Pick Up Only • Expires 12/01/96



### HOWIE'S SPECIAL

Pepperoni, Mushroom, Ham,  
Green Pepper, Onion

(Sorry, No substitutions - deletions OK)

Medium Pizza

**\$7.99**

2 Mediums .. \$12.99  
2 Larges .... \$15.99

Plus Tax • Delivery Extra • Limited Area • Expires 12/01/96



### PRICE BENDER

LIMITED  
TIME  
OFFER

**\$10.99**

- One Medium Pizza With 2 Toppings
- One Howie Bread
- One 2 Liter Of Coke

Plus Tax • Delivery Extra • Limited Area • Expires 12/01/96



### DOUBLE TOPPER

2 Cheese Pizzas  
With Any Two Toppings

2 Smalls

**\$8.99**

(Additional Toppings Extra)

2 Mediums .. \$10.99  
2 Larges .... \$12.99

Plus Tax • Delivery Extra • Limited Area • Expires 12/01/96



### 3-CHEESER HOWIE BREAD OR WINGS

16 Pieces Of Hot Buttered  
Garlic Bread Smothered  
With Mozzarella, Cheddar  
and Parmesan Cheese.  
Sauce Included.

**\$3.49**

10 HOWIE WINGS

(Buffalo Style  
Chicken Wings)

**\$3.99**

Plus Tax • Expires 12/01/96



### PARTY PACKAGE

Two Large Pizzas (One Item)  
Large Salad  
2 Liter of Coke

**\$15.99**

Plus Tax • Delivery Extra • Limited Area • Expires 12/01/96



#### UNION LAKE

3183 Union Lake Road  
(South of Commerce Road)

**363-2050**

#### MILFORD

238 SUMMIT  
(Next to Secretary of State)

**684-6303**

#### WALLED LAKE

954 N. Pontiac Trail  
(North of Maple Road)

**624-8006**

#### NORTHVILLE

555 Seven Mile Road  
(Across from McDonald Ford)

**305-8376**

ORIGINAL • SESAME • BUTTERED • RYE • POPPY SEED • GARLIC • CAJUN • BUTTERED CHEESE

# **\$ANTA' \$URPLUS<sup>®</sup>**

## **Toy & Gift Outlet Store**

Santa has arrived with terrific bargains on toys, gifts, home decor, kitchen gadgets and Christmas decorations!  
Save on name brands, overstocks, closeouts, and discontinued lines!



**SAVE 63%**

**NOW \$14.88**

**RETAIL VALUE  
\$39.89**

**MESSAGE FROM SANTA.** Give Santa's chair a push he'll say "Ho, ho, ho, Merry Christmas," along with some other holiday chatter. Requires two AA batteries. 6 1/4"W x 10"D x 17"H. (18 mos & up).



**SAVE  
25%-71%**

**Register to win a Hawaiian Holiday for two or you may win a \$50 shopping spree!**

**QUANTITIES LIMITED  
SHOP EARLY FOR BEST SELECTION!**



**SAVE 53%**  
**NOW \$13<sup>99</sup>**  
RETAIL VALUE  
~~\$28.99~~

**RODEO  
CLAUS  
DOOR  
DECOR.**

Press  
Rudolph's  
hoof and

Santa sings a western-  
style "Santa Claus is  
Coming to Town."  
Stuffed nylon. 15"W x  
21"H.

**NUTCRACKER  
CANDLEHOLDER.** A  
Christmas classic!  
Wood with plush beard  
and hair. 9 3/4"H.



**SAVE 67%**  
**NOW \$2<sup>99</sup>**  
RETAIL VALUE  
~~\$8.99~~



**SAVE 58%**  
**NOW \$16<sup>99</sup>**  
RETAIL VALUE  
~~\$39.99~~

**INSIDE SANTAS  
WORKSHOP.**  
Polyresin figurine  
with glass water  
ball. Plays assorted  
Christmas tunes.  
8"H.



**MY FIRST DASHBOARD.**  
Guide the car along the  
moving screen. Full of  
light and sound effects!  
11 1/2"W x 9"D x 4"H.  
(3 yrs & up).

**SAVE 33%**  
**NOW \$9<sup>99</sup>**  
RETAIL VALUE  
~~\$14.99~~

**GOLDEN OLDIES  
BANK.** Plays three  
Golden Oldies tunes.5  
1/4"W x 4"D x 7 3/4"H.  
(3 yrs & up).



**SAVE 25%**  
**NOW \$17<sup>99</sup>**  
RETAIL VALUE  
~~\$23.99~~



**SAVE 53%**  
**NOW \$6<sup>99</sup>**  
RETAIL VALUE  
~~\$14.99~~

**BELLS OF  
CHRISTMAS.**  
Five brass  
bells are  
secured on  
satiny bur-  
gundy cords  
and hang from  
a brass ring to  
slip over a  
doorknob.  
25"L.



**SAVE  
UP TO  
60%**

**63-PIECE ASSORTED ANIMAL  
PUZZLES.**

\$1.19/each Retail Value \$2.99

**100-PIECE ASSORTED PUZZLES.**

\$1.49/each Retail Value \$2.99

**500-PIECE ASSORTED PUZZLES.**

\$1.99/each  
Retail Value \$3.59

**1000-PIECE ASSORTED  
LANDSCAPE PUZZLES.**

\$2.99/each  
Retail Value \$3.99

**SESAME STREET FRAME TRAY  
PUZZLE.**

\$1.99/each  
Retail Value \$3.99

**GOLDEN DIAMOND  
MUGS.** Set of four.  
Retail Value \$22.99



**\$6.66**  
**SAVE  
71%**

**COCA-COLA®  
SANTA &  
POLAR-  
BEAR.**  
Retail Value  
\$12.99



**SAVE  
46%**

**\$6.99**



**SAVE  
58%**

**KENNER® DELUXE VR  
TROOPER.**  
Retail Value \$11.99

**\$4.99**



**SAVE  
32%**

**GALAXY  
SHOOTER.**  
Retail Value  
\$9.99

**\$6.79**



**KENYA'S COUSIN.** Choose from three 6 1/2" dolls. Each comes with an African princess ensemble and a contemporary outfit and assorted accessories. (3 yrs & up).

**SAVE 60%**  
**NOW \$3.99**  
EACH  
**RETAIL VALUE \$9.99**

**SAVE 50%**  
**NOW \$2.49**  
EACH  
**RETAIL VALUE \$4.99**



**GLITTER ART.** Use acrylic jewels and Glitter to create pretty designs. (6 yrs & up).

**LITTLE KIDDLES™ ASSORTMENTS.** Choose from four tiny doll playsets. (4 yrs & up).

**SAVE 50%**  
**NOW \$1.99**  
EACH  
**RETAIL VALUE \$3.99**



**SAVE 50%**  
**NOW \$4.99**  
EACH  
**RETAIL VALUE \$9.95**

**SIGHT & SOUND BOOK ASSORTMENT.** Choose from eight titles. (3 yrs & up).



**BARBIE® FANCY DATE FASHIONS.** Choose from five complete outfits. Doll not included. (3 yrs & up)

**SAVE 40%**  
**NOW \$2.99**  
EACH  
**RETAIL VALUE \$4.99**

**SLUMBER PARTY BARBIE®.** Huggable, soft-bodied 11 1/2" Barbie in take-along tote with hair brush and glow-in-the-dark stickers. Apply warm water to her eyes and they close, cold water makes them open again! (3 yrs & up).

**SAVE 33%**  
**NOW \$9.99**  
EACH  
**RETAIL VALUE \$14.99**

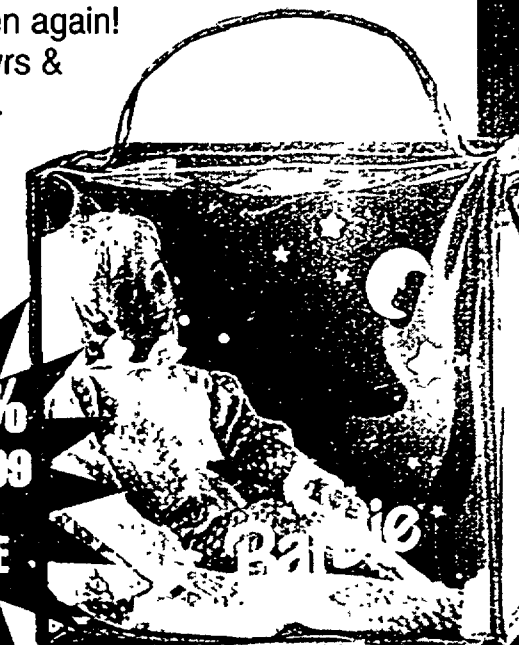

**BAYWATCH™ BARBIE® LIFEGUARD DRESS-UP SET.** Five lifeguard accessories for fun Barbie adventures. Doll not included. (3 yrs & up).



**SAVE 52%**  
**NOW \$11.88**  
EACH  
**RETAIL VALUE \$24.99**

**FLOWER MAGIC MARY™.** Beautiful scented flowers magically bloom from Mary's watering can to decorate her and you! Choose from three 13" vinyl dolls. Accessories and styling guide included. (3 yrs & up). Blonde & black dolls available.

**SAVE 52%**  
**NOW \$11.99**  
EACH  
**RETAIL VALUE \$24.99**



**SAVE 25%**

**\$2.99**

**DOUBLE NINE WOODEN DOMINOS.** Retail Value \$3.99

**SAVE 50%**

**\$.50** EACH

**DISNEY COLOR BOOK ASSORTMENT.** Retail Value \$.99



**SAVE 60%**

**CRAYOLA® WASHABLE MARKERS.** Retail Value \$4.99

**\$1.99**



**SAVE 40%**

**\$1.19** EACH

**LOONEY TUNES™ CHUNKY COLOR/ACTIVITY BOOKS.** Retail Value \$1.99



**SAVE 30%**

**15 WIPE-OFF GAMES.** Retail Value \$4.99

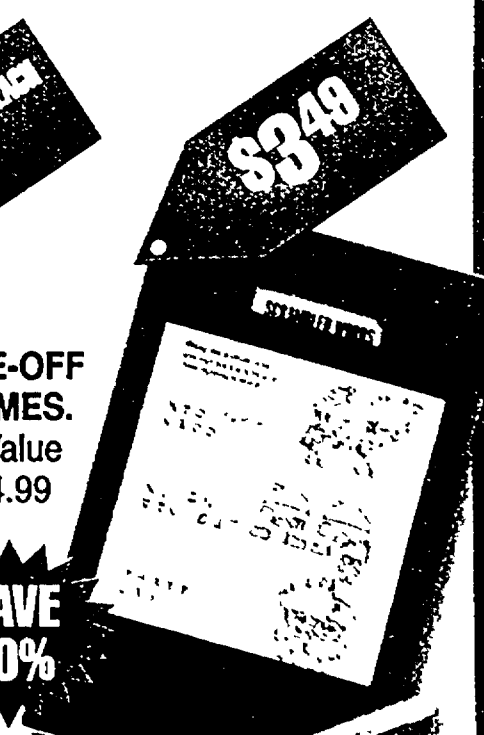

**SAVE 25%**  
**NOW \$3.89**  
EACH  
**RETAIL VALUE**  
**\$5.29**

**BURAGO 1/43 DIE CAST CARS.** Choose from 24 import sports cars.

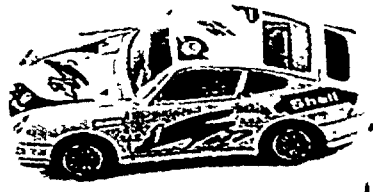
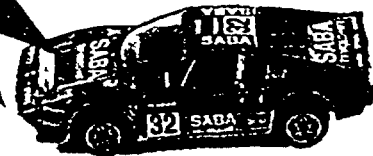
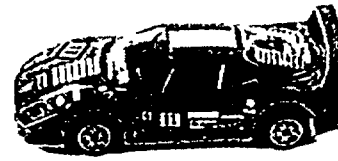
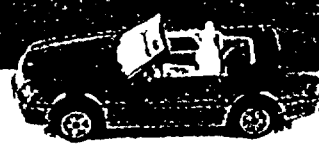

**SAVE 50%**  
**NOW \$2.49**  
EACH  
**RETAIL VALUE**  
**\$4.99**

**HASBRO® GI JOE ACTION FIGURE.** Choose from four action heroes, each with accessories. (3 yrs & up).

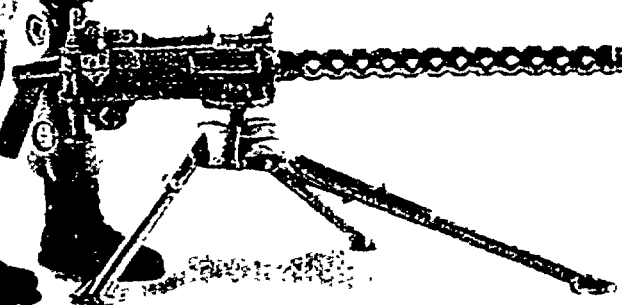

**BASKETBALL PLAYOFF.** Adjustable goal (4 sizes up to 47") with inflatable vinyl ball. (3 yrs & up).

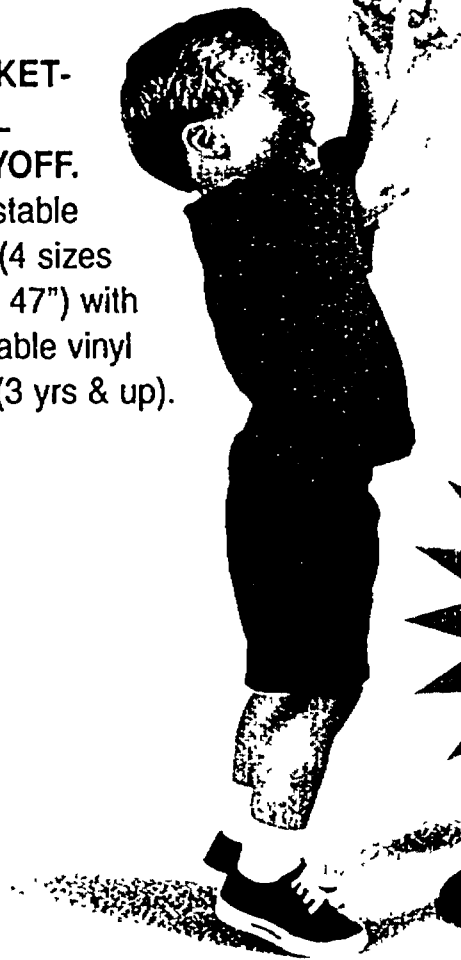

**SAVE 40%**  
**NOW \$11.89**  
EACH  
**RETAIL VALUE**  
**\$18.85**

**SAVE 42%**  
**NOW \$5.79**  
EACH  
**RETAIL VALUE**  
**\$9.89**

**CLASSIC EXPRESS TRAIN.** Battery-operated train engine with three cars and eight feet of track. (5 yrs & up).

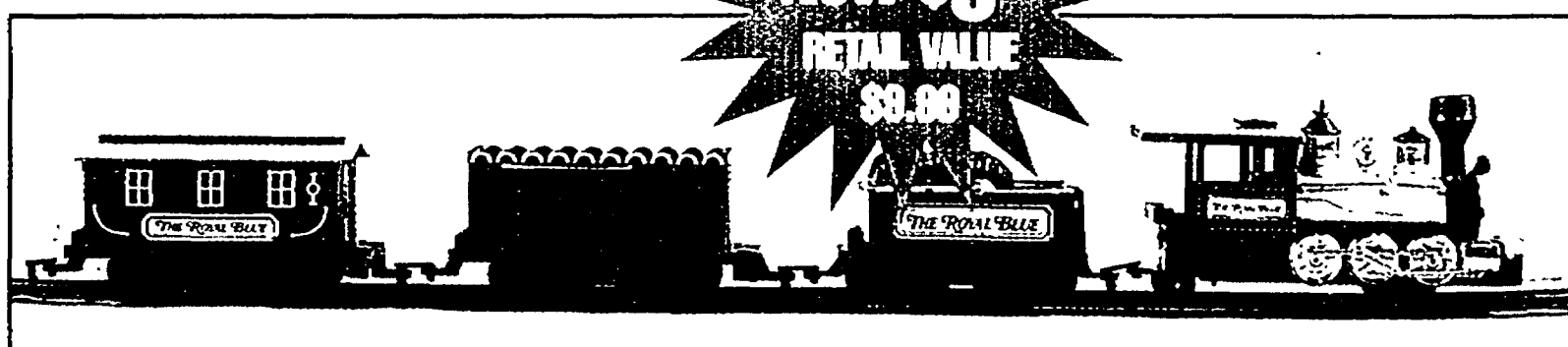

**SAVE 35%**

**ARNOLD PALMER CLASSIC GOLF BALLS.** 16-pack  
 Retail Value \$19.99

**SAVE 62%**

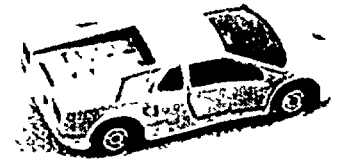
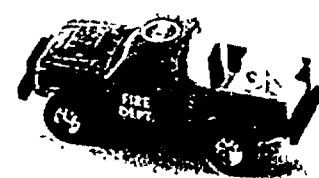
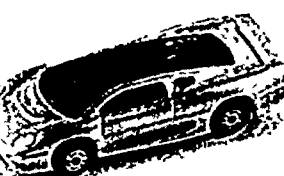
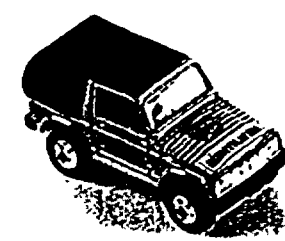

**TURBO TREAD.**  
 Retail Value \$1.29

**\$ .49**  
EACH



16" DUMP TRUCK. Huge metal dump truck with plastic parts. Great sand-box fun! (3 yrs & up).

**SAVE 35%**  
**NOW \$12<sup>99</sup>**  
**RETAIL VALUE**  
**\$18.99**

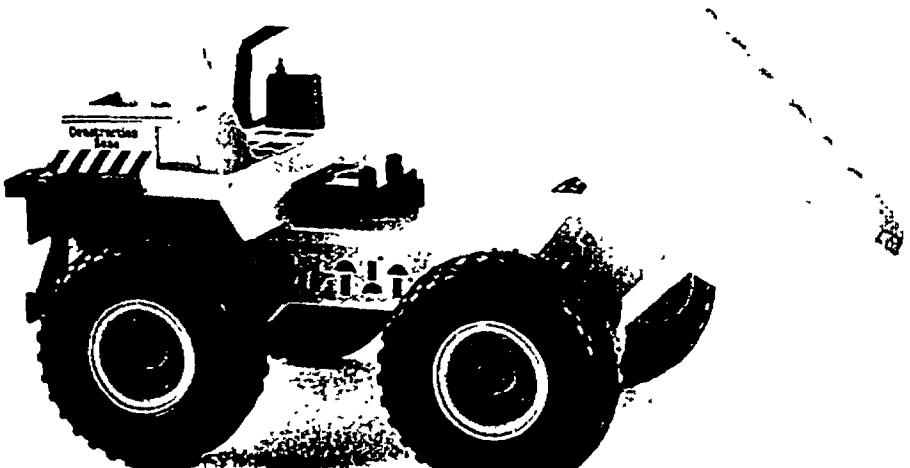

**You may win a \$50 shopping spree!**  
**Register to win a Hawaiian Holiday for two!**

Three \$50 drawings will be held Nov. 30th, Dec. 7th, and Dec. 14th. The Hawaii Trip winner will be chosen from the weekly drawing winners.

You and your companion will enjoy eight days and seven nights at the Hyatt Regency Waikiki along with round trip air accommodations.\*

No purchase is necessary. Simply fill out the entry form below and deposit at our store.

Name \_\_\_\_\_  
 Address \_\_\_\_\_  
 City \_\_\_\_\_ State \_\_\_\_\_  
 Zip \_\_\_\_\_ Phone \_\_\_\_\_

\* Airline accommodations are from the nearest major gateway. Travel dates are subject to availability and any airline restrictions applicable. Travel may be completed by Dec. 1, 1997 (again based upon any airline restrictions). The recipient will be responsible for any applicable taxes.

RADIO CONTROL FALCON. Battery-controlled race car goes forward, reverse, with controlled steering. (3 yrs & up).

**SPECIAL BUY**  
**\$9<sup>99</sup>**



**SAVE 40%**  
**L.A. ROCK RADIO EAPHONES.**  
 Retail Value \$9.99

**\$5<sup>99</sup>**

**SAVE 40%**  
**SPORTS BALL ASSORTMENT.**  
 Retail Value \$4.99





**Bonus Buy!**  
**Only \$2.50**  
**with a \$25**  
**purchase.**

**PATCHWORK ANGEL.** Sweet little angel of homespun treasures will enhance decor year-round. Stuffed fabric with springy acrylic yarn hair. 17"H. RETAIL VALUE \$14.99

WHILE QUANTITIES LAST

**SAVE**  
**25% to 71%**  
Charge your order on VISA,  
MasterCard, or Discover.  
It's easy!



**VISIT YOUR**  
**\$ANTA' \$URPLUS®**  
**STORE AT THIS**  
**LOCATION:**

**SANTA SURPLUS**  
**43484 WEST OAKS DRIVE**  
**NEXT TO KIDS R US**  
**NOVI, MI. 48377**

#764 - HOMETOWN NEWS 11/27

All stores locally owned. Quantities limited. Shop early for best selection!

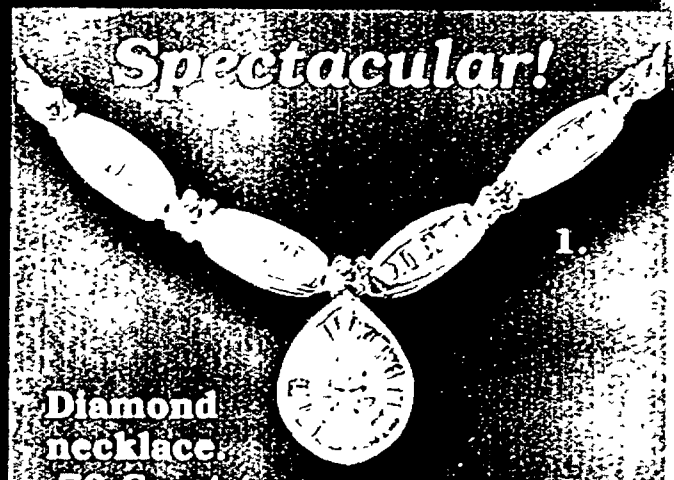

**Spectacular!**

Diamond necklace,  
70 Carat t.w.

**SALE \$1299**

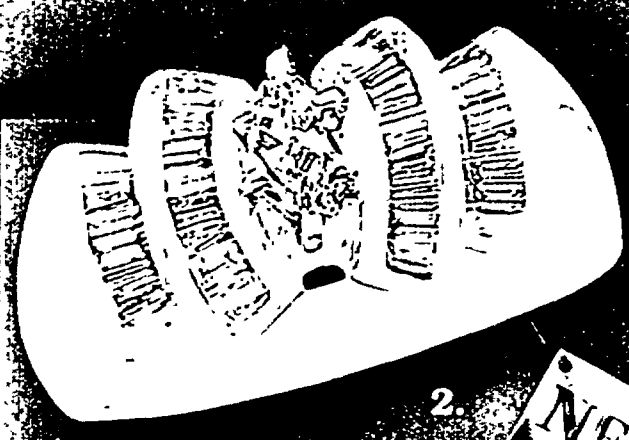

2.

**NEW**

Baguettes highlighted by  
a marquise center diamond.

**SALE \$1299**

As Low As \$80 Per Month

**INSTANT CREDIT!**

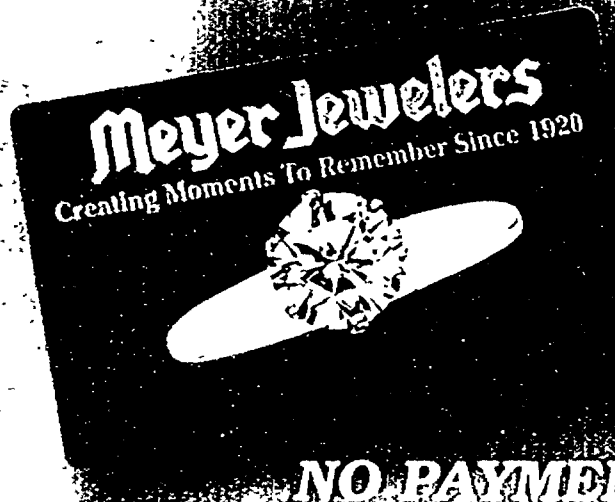

**NO PAYMENTS  
NO INTEREST  
TILL 1997!**

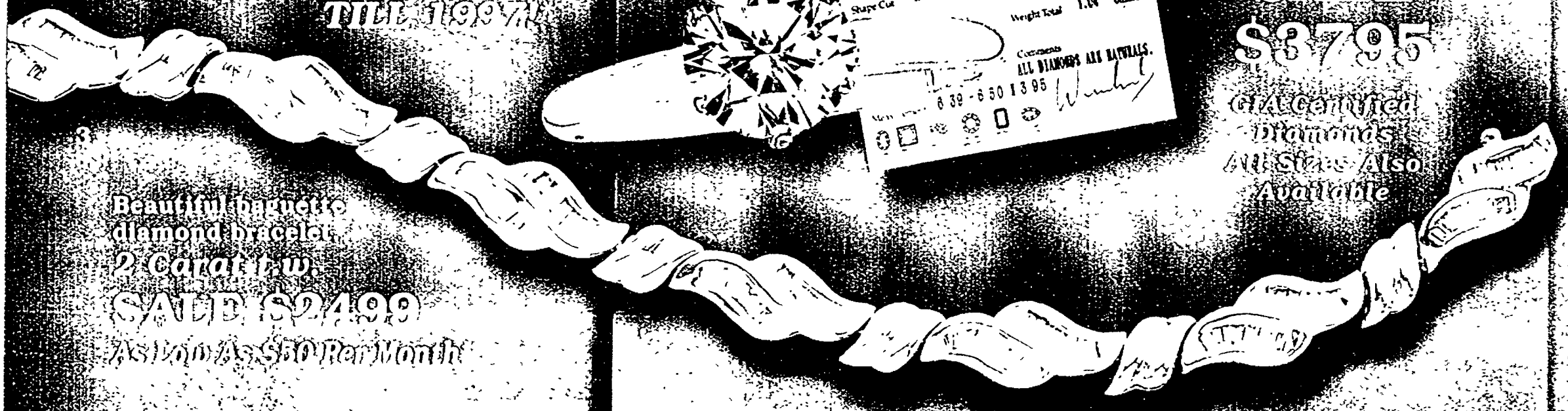

Beautiful baguette  
diamond bracelet.

2 Carat t.w.

**SALE \$2499**

As Low As \$80 Per Month

# Meyer Jewelers

## SPECTACULAR CHRISTMAS DIAMOND SALE

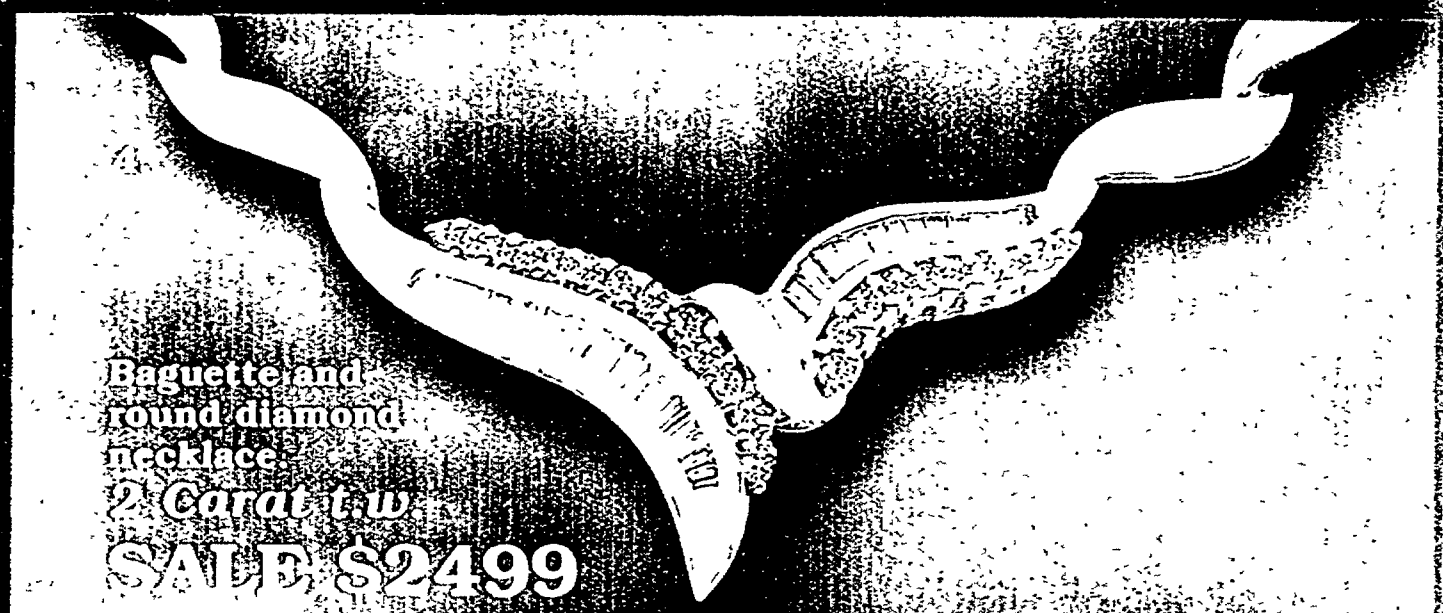

Baguette and  
round diamond  
necklace

2 Carat t.w.

**SALE \$2499**

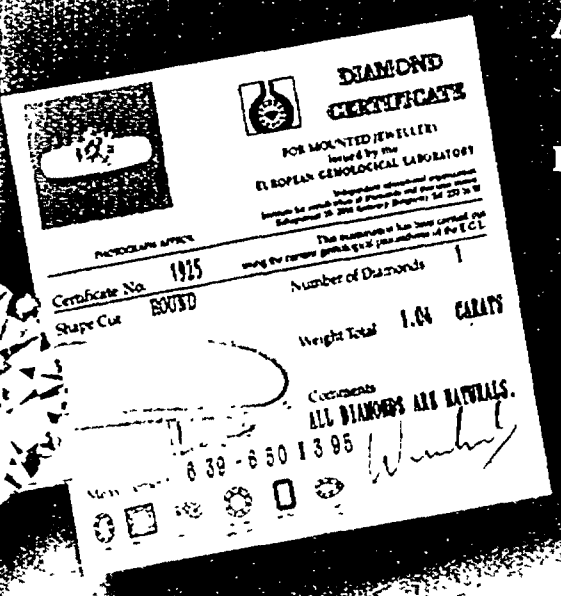
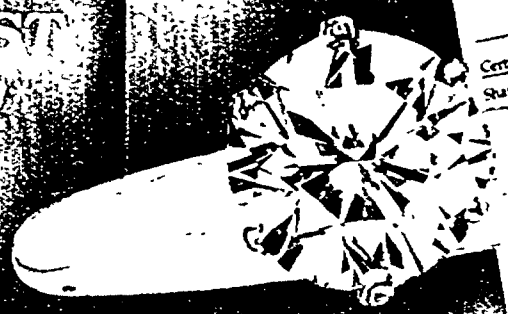

A full One Carat Solitaire  
is certified and  
mounted in 14Kt. gold.  
Protected by our lifetime  
diamond guarantee.

**SALE  
\$3795**

GIA Certified  
Diamonds  
All States Also  
Available

# BECAUSE CHRISTMAS ONLY COMES ONCE A YEAR

To Our Valued Customer,

As you browse through our Christmas Collection, you will discover a magnificent selection of stunning diamond and gemstone jewelry, gold fashion chains and bracelets, famous name watches and gift items from the worlds most prestigious market places.

You will find friendly and courteous Meyer associates to assist you in making just the right selection.

At Meyer Jewelers our uncompromising standards for quality assure you of the very best value. We guarantee optimum quality at the very best prices, because we know that is what you expect from us.

We take seriously the trust and confidence you entrust to us. We've been your hometown jeweler for 76 years.

Happy Holidays  
from the entire Meyer Jewelers family.

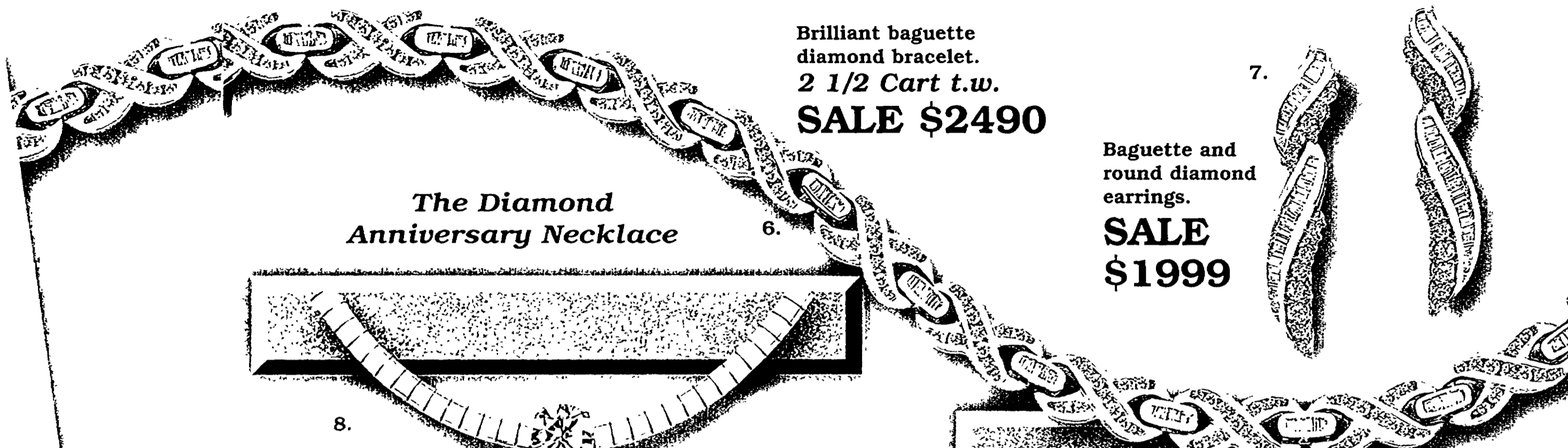

**The Diamond Anniversary Necklace**

Brilliant baguette diamond bracelet.  
2 1/2 Cart t.w.  
**SALE \$2490**

Baguette and round diamond earrings.  
**SALE \$1999**

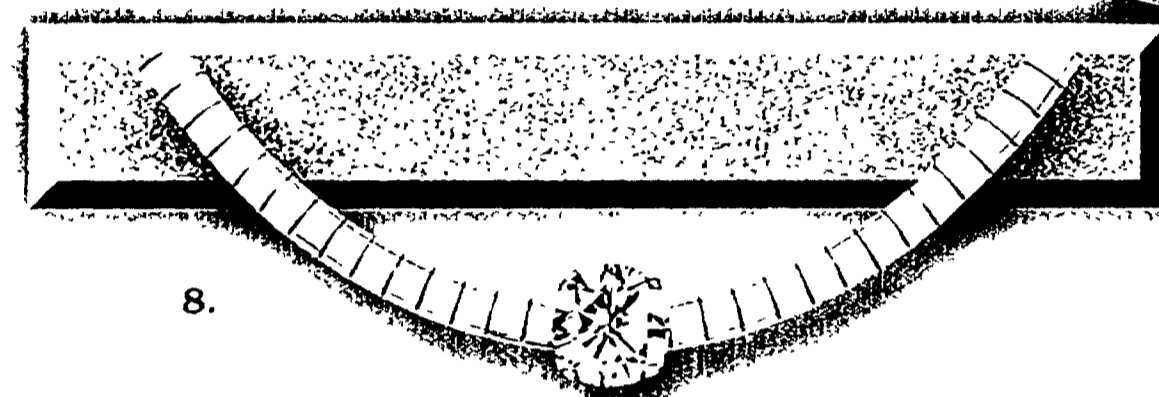

The diamond anniversary necklace.  
**SALE \$2299**

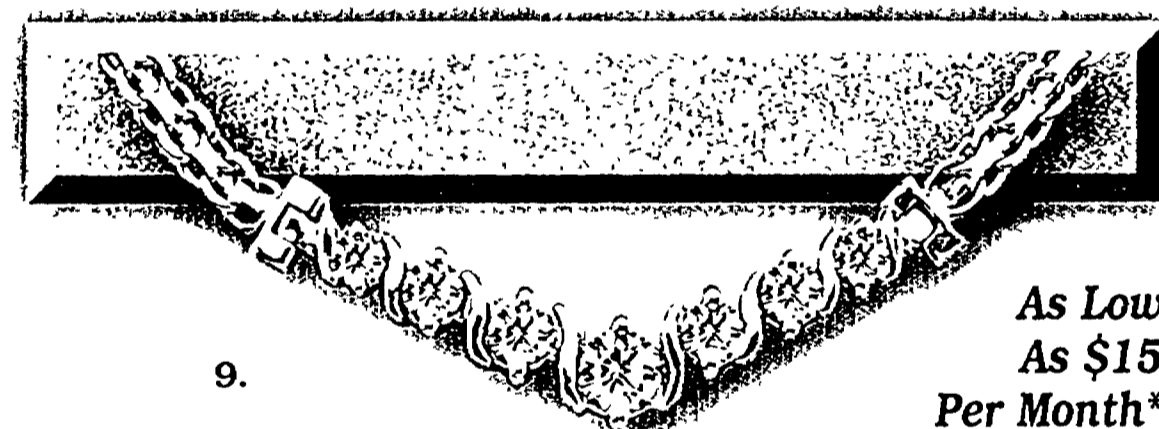

**The Gift of a Lifetime...**  
"S" style anniversary necklace.  
1/2 Carat t.w.  
**SALE \$599**

As Low  
As \$15  
Per Month\*



**Diamond Fashion Bracelets**

1 Carat t.w.  
**SALE \$899**

As Low  
As \$20  
Per Month\*

1 Carat t.w.  
**SALE \$899**

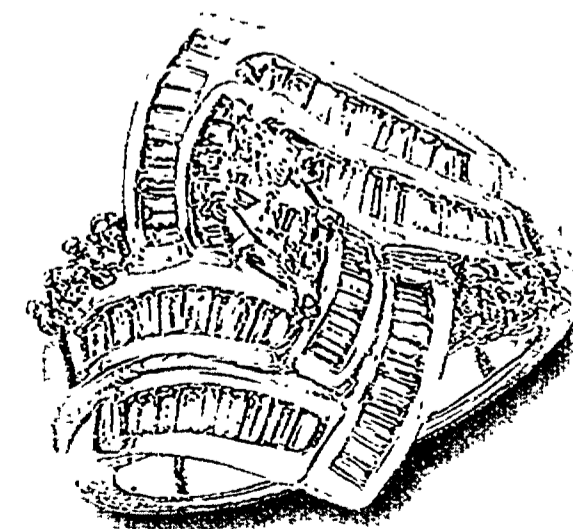

Baguettes surrounding a marquise center.  
**SALE \$2499**  
As Low As \$50 Per Month\*

**INSTANT CREDIT!**



**NO PAYMENTS  
NO INTEREST  
TILL 1997!\***

# EXPRESS YOUR LOVE THIS HOLIDAY

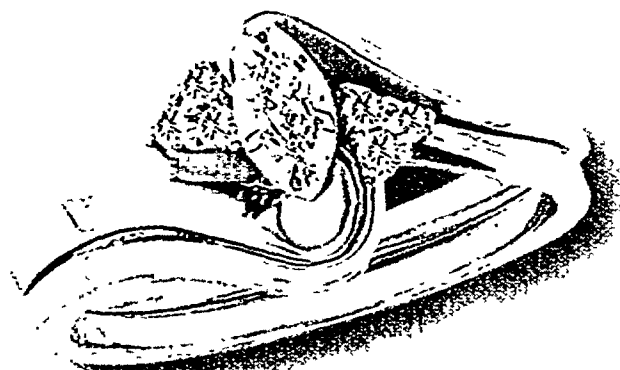

13. Stunning round diamond bridal set with marquise center.  
**SALE \$299**

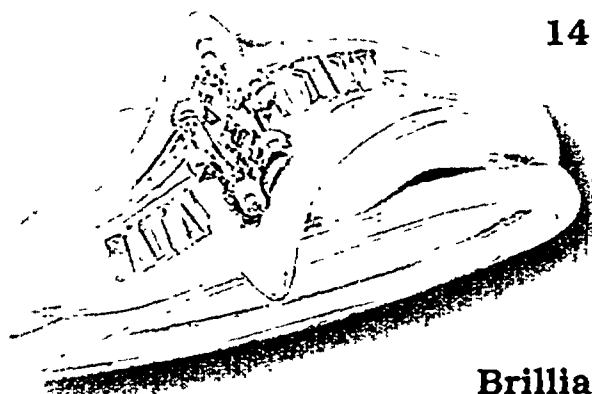

14. Brilliant marquise and baguette diamond bridal.  
**SALE \$399**  
As Low As \$15 Per Month\*

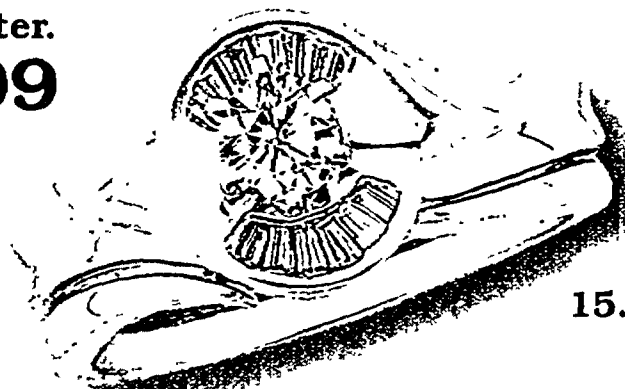

15. Baguette and round diamond bridal set.  
**SALE \$599**

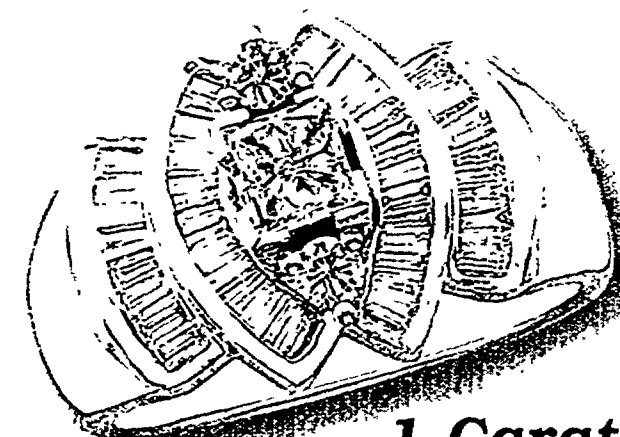

16. Baguettes surrounding a princess cut center.  
**SALE \$2199**

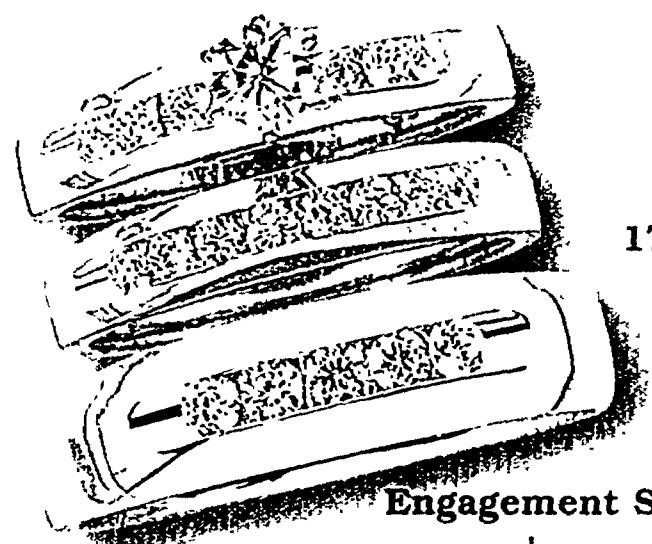

17. Engagement Set.  
.60 Carat t.w. **SALE \$999**  
Men's diamond band.  
1/4 Carat t.w. **SALE \$449**  
**All Three For \$1299**

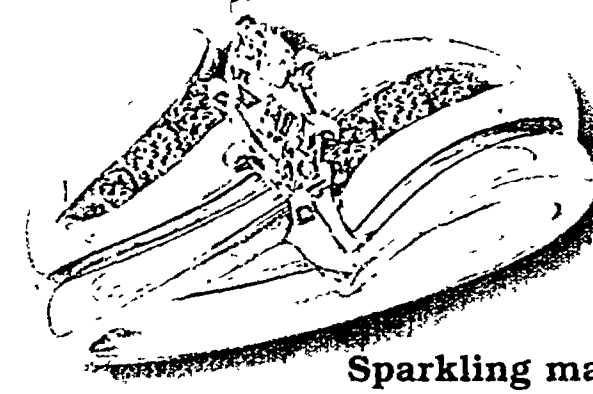

21. Sparkling marquise and round diamond bridal.  
**SALE \$799**  
As Low As \$20 Per Month\*

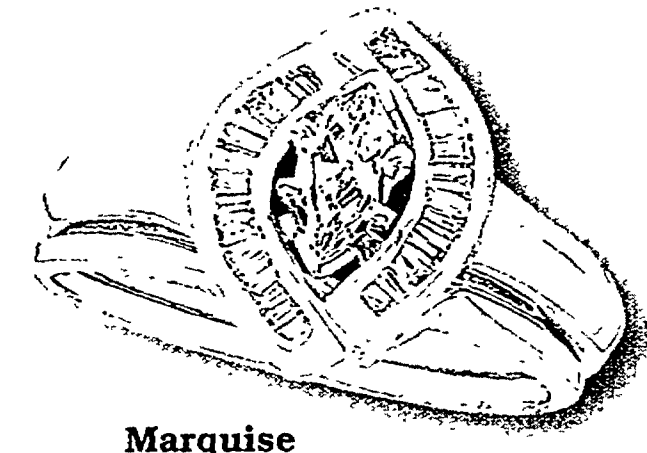

22. Marquise and baguette bridal.  
**SALE \$899**  
As Low As \$20 Per Month\*

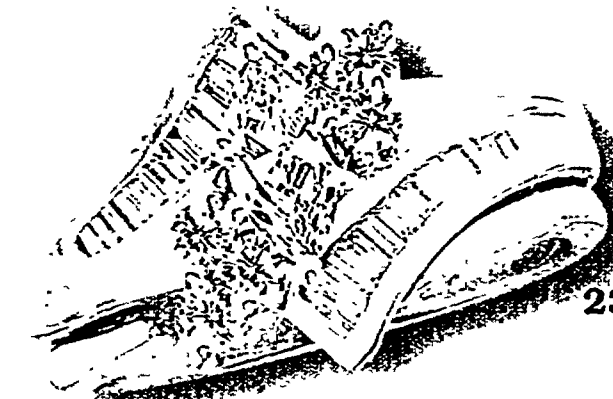

23. Baguette diamonds with a marquise center.  
.75 Carat t.w.  
**SALE \$1999**  
As Low As \$40 Per Month\*

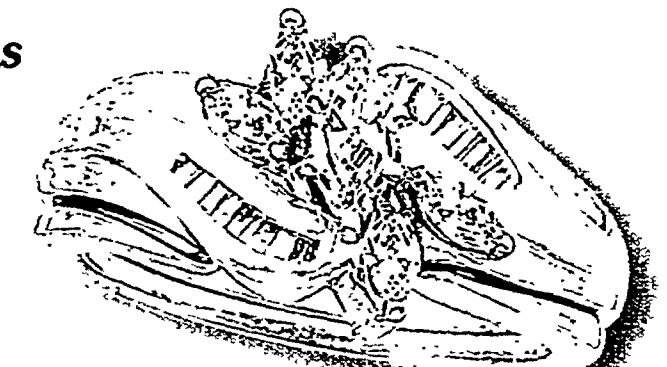

24. Marquise center surrounded by baguettes.  
.50 Carat t.w.  
**SALE \$1099**  
As Low As \$25 Per Month\*



25. Baguette and round diamond bridal set.  
**SALE \$1099**

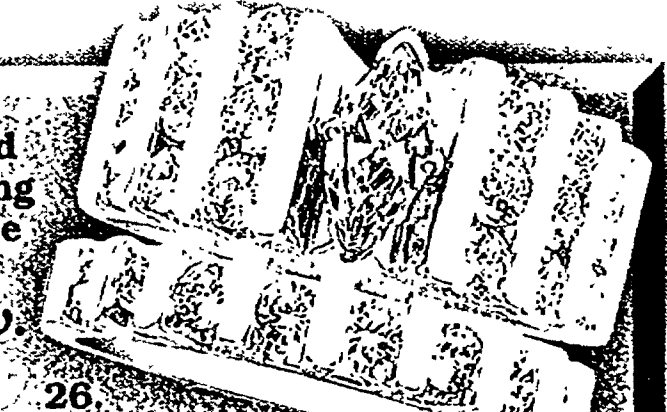

26. Round diamond engagement ring with a marquise center.  
1 Carat t.w. **SALE \$1499**  
Matching diamond band.  
1/3 Carat t.w. **SALE \$399**

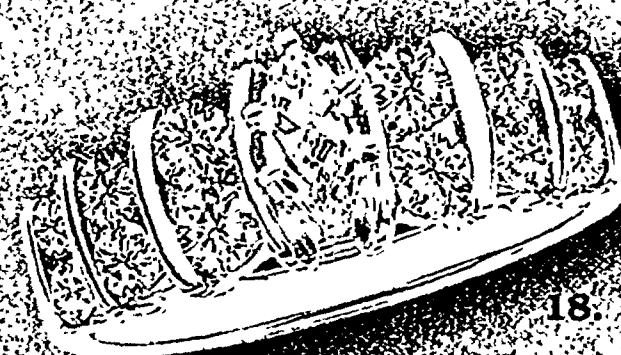

18. Marquise center surrounded by round diamonds.  
1 Carat t.w.  
**SALE \$1699**  
As Low As \$35 Per Month\*

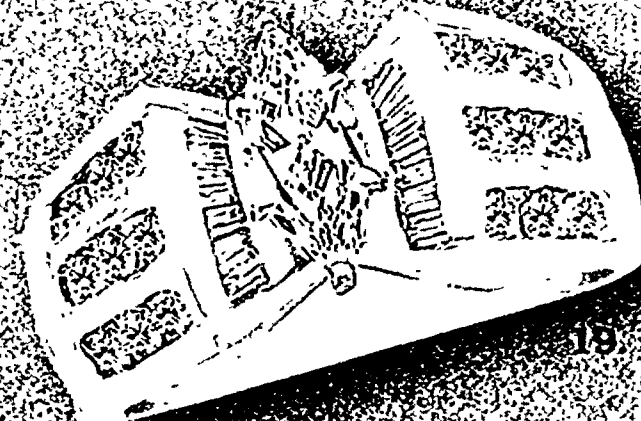

19. Baguette and round diamonds with a marquise center.  
1 1/4 Carat t.w.  
**SALE \$1999**  
As Low As \$40 Per Month\*

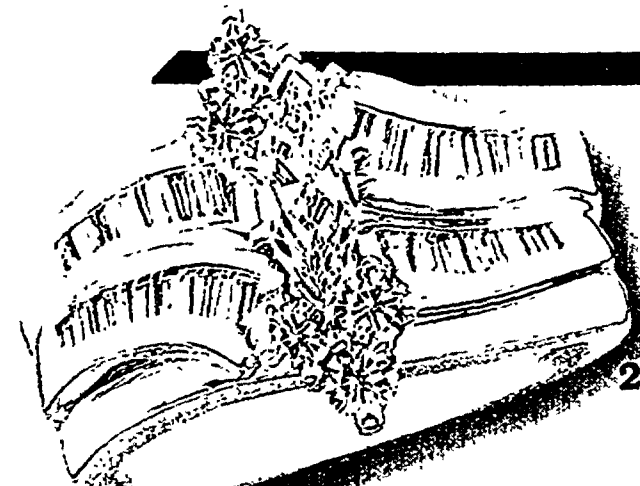

20. Combination of baguette, marquise and round diamond bridal set.  
1 Carat t.w.  
**SALE \$2199**  
As Low As \$45 Per Month\*



**INSTANT CREDIT!**  
NO PAYMENTS  
NO INTEREST  
TILL 1997!\*

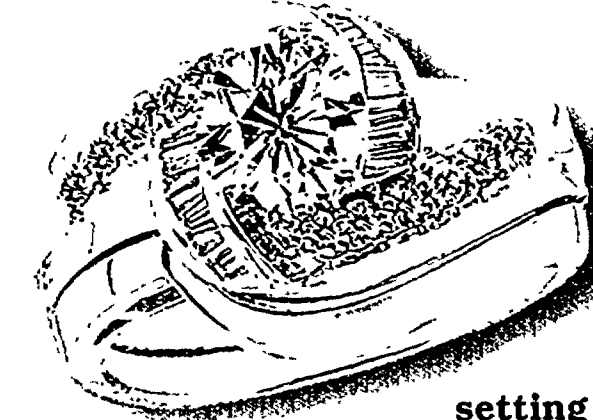

27. A spectacular setting of baguettes and a sparkling round center.  
**SALE \$1499**  
As Low As \$30 Per Month\*



28. Baguette diamonds with a marquise center.  
**SALE \$1299**

# IN THE SPIRIT OF CHRISTMAS

**Diamond Solitaires**  
 .10 Carat  
**SALE \$149**



29A.



29B.

1/5 Carat  
**SALE \$249**

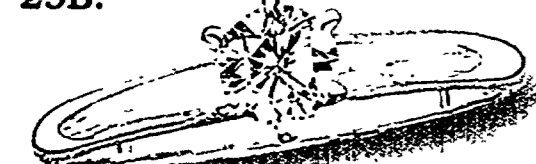

29C.

1/4 Carat  
**SALE \$299**



29D.

1/3 Carat  
**SALE \$399**



29E.

1/2 Carat  
**SALE \$799**



29F.

5/8 Carat  
**SALE \$999**



29G.

3/4 Carat  
**SALE \$1199**



29H.

1 Carat  
**SALE \$2499**

Marquise diamond solitaires set in 14Kt. gold

**SALE**

1/5 Ct. **\$499**  
 1/4 Ct. **\$599**  
 1/3 Ct. **\$799**  
 1/2 Ct. **\$1299**

31.



37.  
 Marquise center surrounded by round diamonds.  
 3/4 Carat t.w.  
**SALE \$999**



**INSTANT CREDIT!**

**NO PAYMENTS NO INTEREST TILL 1997!\***

Baguettes and round diamonds  
**SALE \$299**

38.

Round diamond band with a 1/2 Carat center diamond  
**SALE \$999**  
 As Low As \$20 Per Month\*

39.

Marquise and baguette diamond ring  
**SALE \$1999**  
 As Low As \$40 Per Month\*

40.

Round and baguette diamonds with a marquise center.  
 1 Carat t.w.  
**SALE \$1499**

32.

**As Low As \$30 Per Month\***

Beautiful baguette diamond ring.  
 1 Carat t.w.  
**SALE \$699**

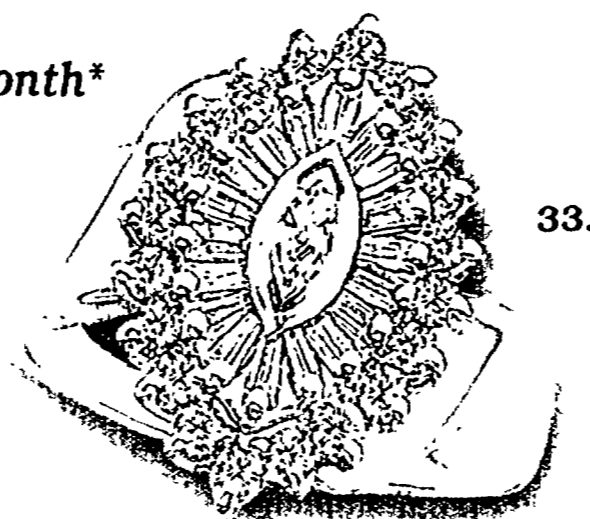

33.

## Fancy Shaped Diamond Fashion Rings

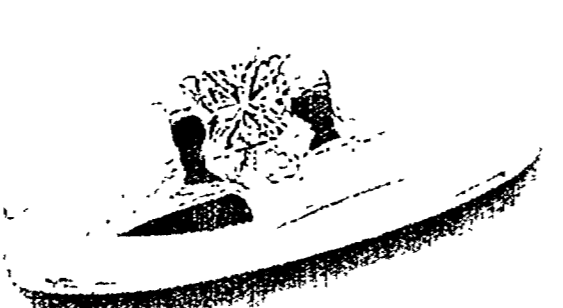

34. Princess-Cut ring.

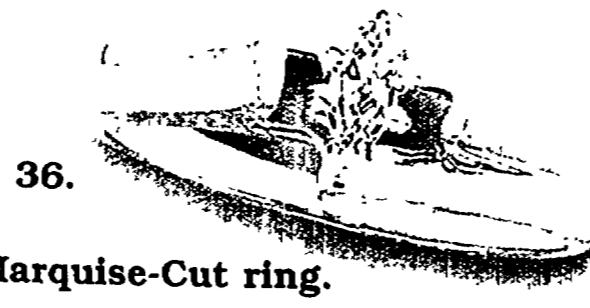

35. Marquise-Cut ring.

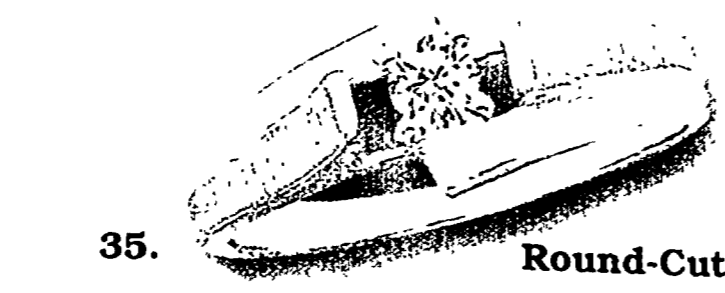

36. Round-Cut ring.

**YOUR CHOICE \$249**

## Enhance Your Solitaire

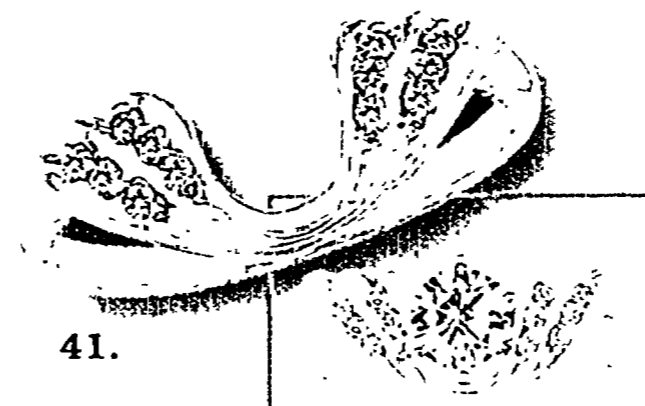

41.  
 Diamond and gold swirl wrap.  
**SALE \$199**  
 Solitaire sold separately  
 As Low As \$15 Per Month\*

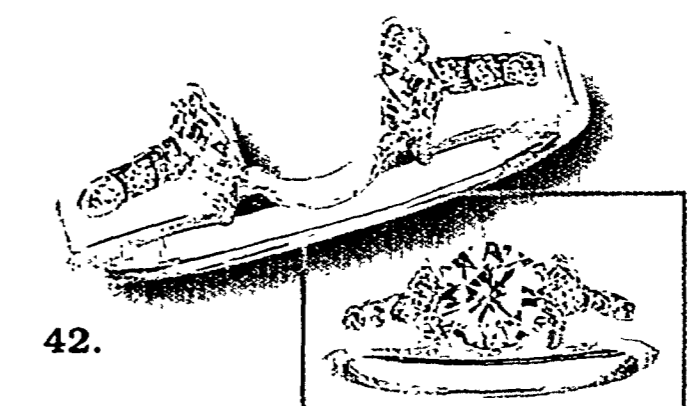

42.  
 Lovely 8 marquise and round diamond wrap.  
**SALE \$599**  
 Solitaire sold separately  
 As Low As \$15 Per Month\*

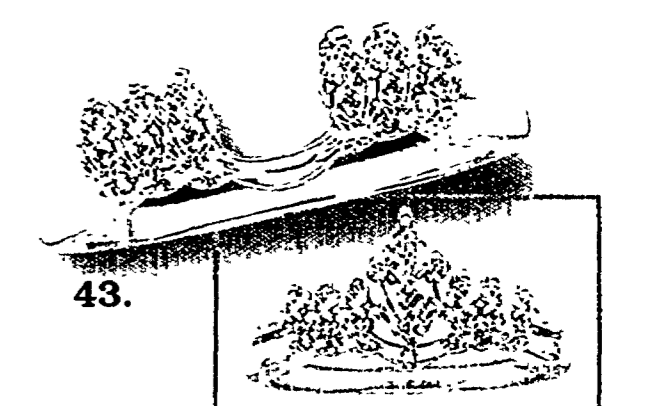

43.  
 Marquise diamond wrap.  
**SALE \$599**  
 Solitaire sold separately  
 As Low As \$15 Per Month\*

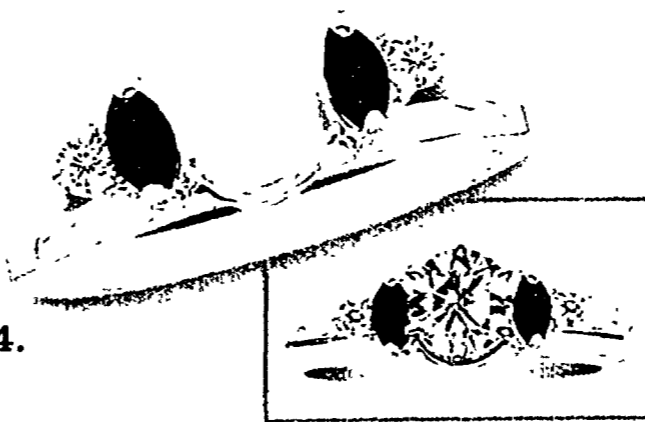

44.  
 Marquise ruby and diamond wrap  
**SALE \$199**  
 Solitaire sold separately  
 As Low As \$15 Per Month\*

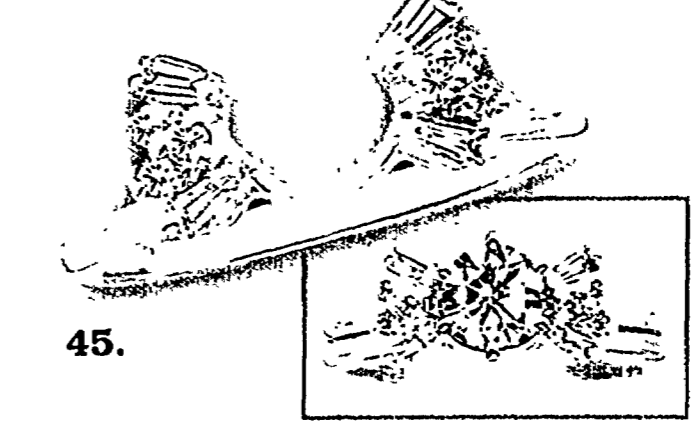

45.  
 Baguette and round diamond wrap.  
**SALE \$399**  
 Solitaire sold separately  
 As Low As \$15 Per Month\*

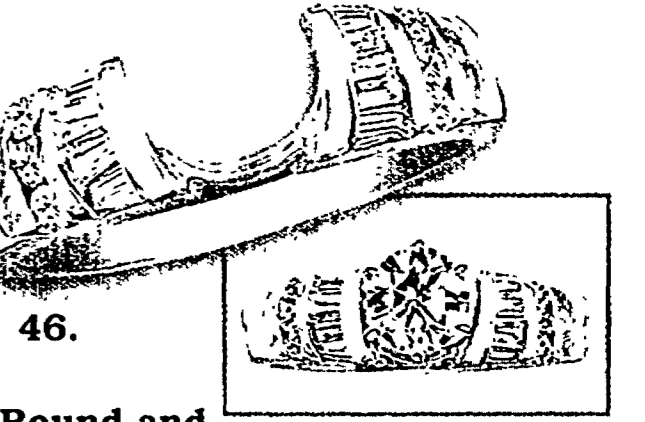

46.  
 Round and baguette diamond wrap.  
**SALE \$599**  
 Solitaire sold separately  
 As Low As \$15 Per Month\*

Baguette and round diamond ring.  
**SALE \$1299**  
 As Low As \$30 Per Month\*

30.



**INSTANT CREDIT!**

**OPEN A**

**Meyer Jewelers**

**CHARGE ACCOUNT**

**TODAY!**

- **No annual fee.**
- **100% financing - no down payment required.**
- **Free Gift with Approved Credit.**

CALL 1-888-99-MEYER  
OR FILL OUT THE EASY CREDIT APPLICATION



# THE JOY OF RECEIVING

47. Diamond stud earrings set in 14Kt. gold.

**SALE**

1/4 Ct.t.w.	<b>\$99</b>
1/3 Ct.t.w.	<b>\$299</b>
1/2 Ct.t.w.	<b>\$399</b>
3/4 Ct.t.w.	<b>\$699</b>
1 Ct.t.w.	<b>\$999</b>

52. Channel set diamond anniversary bands.

**SALE**

1/4 Ct.t.w.	<b>\$299</b>
1/3 Ct.t.w.	<b>\$399</b>
1/2 Ct.t.w.	<b>\$599</b>
1 Ct.t.w.	<b>\$799</b>

53. 7 Marquise diamond anniversary bands.

**SALE**

1/2 Ct.t.w.	<b>\$599</b>
1/4 Ct.t.w.	<b>\$299</b>
1 Ct.t.w.	<b>\$1499</b>

48. Channel set diamond pendant in 14Kt. gold.

**SALE**      **SALE**

1/4 Ct.	<b>\$299</b>	1/2 Ct.	<b>\$1099</b>
1/3 Ct.	<b>\$599</b>	3/4 Ct.	<b>\$1499</b>

**INSTANT CREDIT!**

**Meyer Jewelers**  
Creating Moments To Remember Since 1920

**NO PAYMENTS  
NO INTEREST  
TILL 1997!\***



Heart Pendants

49. 1/4 Carat t.w. **SALE \$199**

50. 1/2 Carat t.w. **SALE \$349**

51. 1 Carat t.w. **SALE \$499**

54. Channel set 1 Carat t.w. diamond band.

**SALE \$1199**

As Low As \$25 Per Month\*

55. Hugs and kisses diamond ring.

**SALE \$99**

56. Princess-cut diamond band. .90 Carat t.w.

**SALE \$1099**

As Low As \$25 Per Month\*

57. Four rows of baguette diamonds.

**SALE**

1/4 Ct.t.w.	<b>\$199</b>
1/2 Ct.t.w.	<b>\$399</b>
1 Ct.t.w.	<b>\$699</b>

58. Swirls of baguette diamonds and gold.

**SALE \$1099**

Instant Credit Payments  
As Low As \$20 Per Month\*

59. Lovely band of channel set round diamonds. 1 Carat t.w.

**SALE \$899**

60. Array of princess cut diamonds. 1 Carat t.w.

**SALE \$2499**

As Low As \$50 Per Month\*

61. 2 Carat t.w. Diamond anniversary band.

**SALE \$1299**

62. Round diamond band.

**SALE \$199**

63. Men's diamond nugget cluster.

**SALE \$499**

**Diamonds For Him**

Men's diamond cluster

**SALE**

1/2 Ct.	<b>\$499</b>
1 Ct.	<b>\$899</b>
1 1/2 Ct.	<b>\$1199</b>

\*On approved credit. This is a Same As Cash offer. Financing is a no payment deferred interest program. If the balance is not paid in full by the plan expiration date, interest will be assessed from the original date of purchase. No finance charge will be assessed if paid in full by the plan expiration date. See Store for details. APR 21.99% Minimum finance charge. .50 cents. Credit provided by Avondale, fsh.

# BECAUSE CHRISTMAS

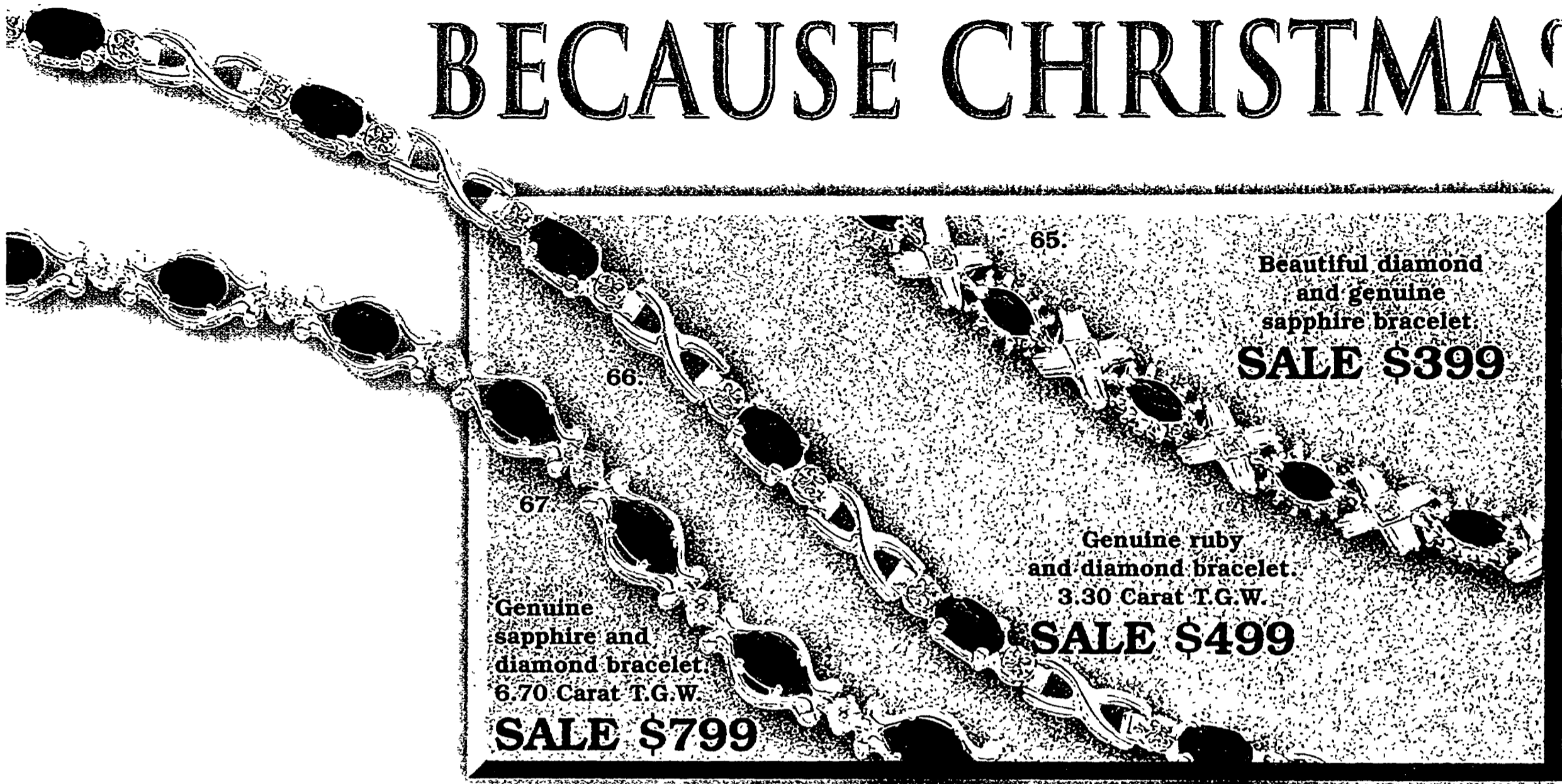

65. Beautiful diamond and genuine sapphire bracelet. **SALE \$399**

66. Genuine ruby and diamond bracelet. 3.30 Carat T.G.W. **SALE \$499**

67. Genuine sapphire and diamond bracelet. 6.70 Carat T.G.W. **SALE \$799**

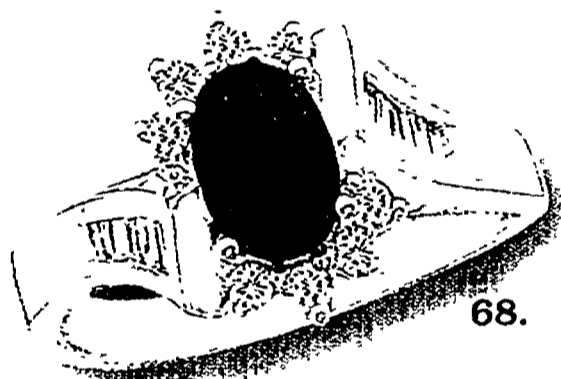

68. Genuine sapphire surrounded by baguette diamonds. **SALE \$899**

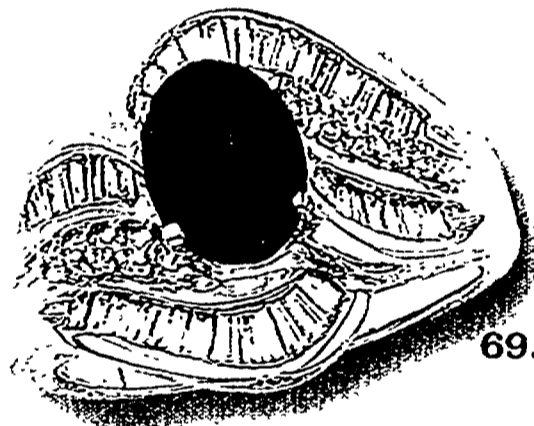

69. Brilliant baguette diamonds surround a genuine sapphire. **SALE \$999**

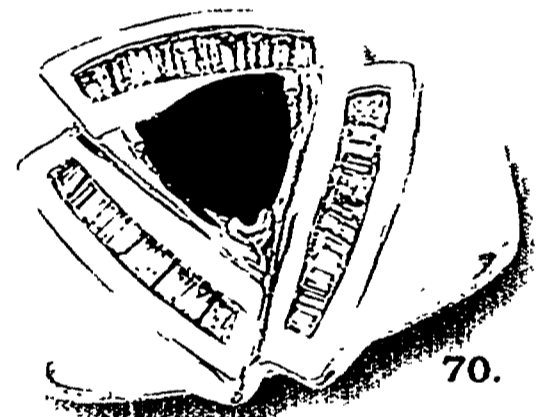

70. Baguette diamond and genuine sapphire. **SALE \$599**

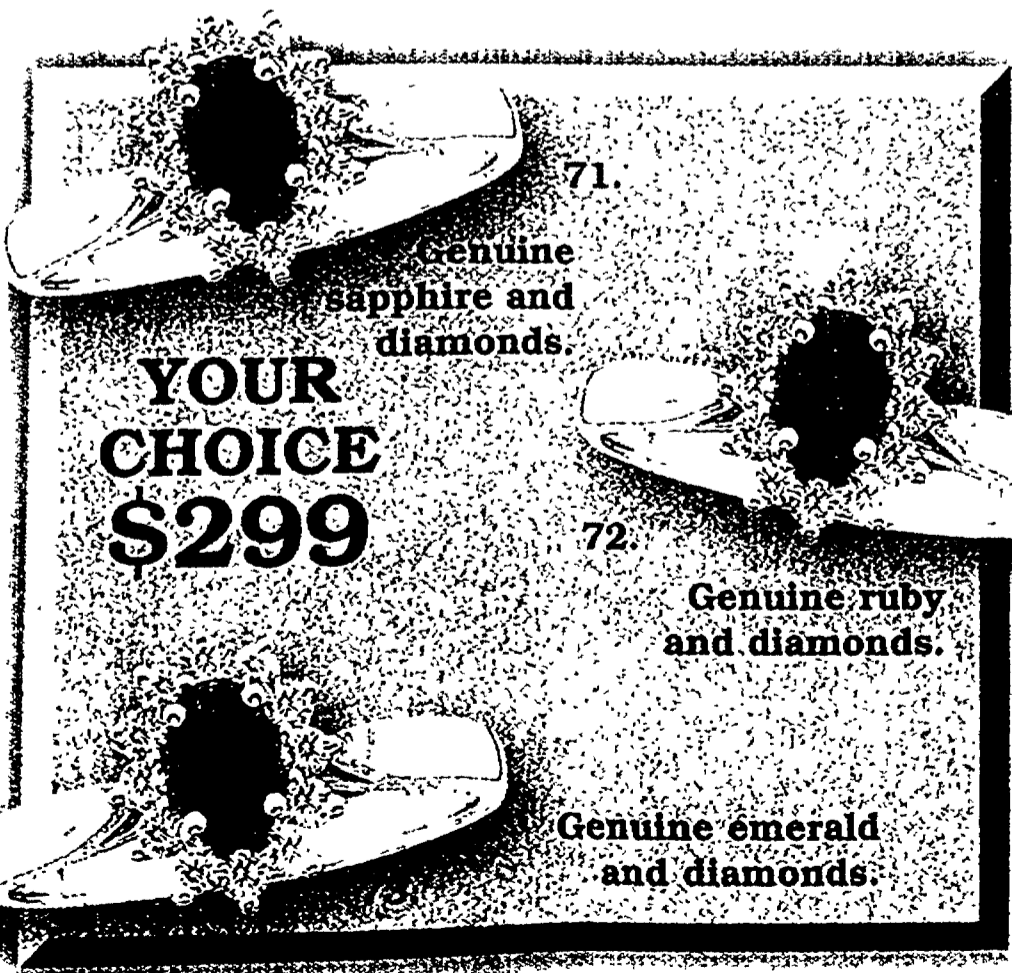

71. Genuine sapphire and diamonds. **YOUR CHOICE \$299**

72. Genuine ruby and diamonds.

73. Genuine emerald and diamonds.

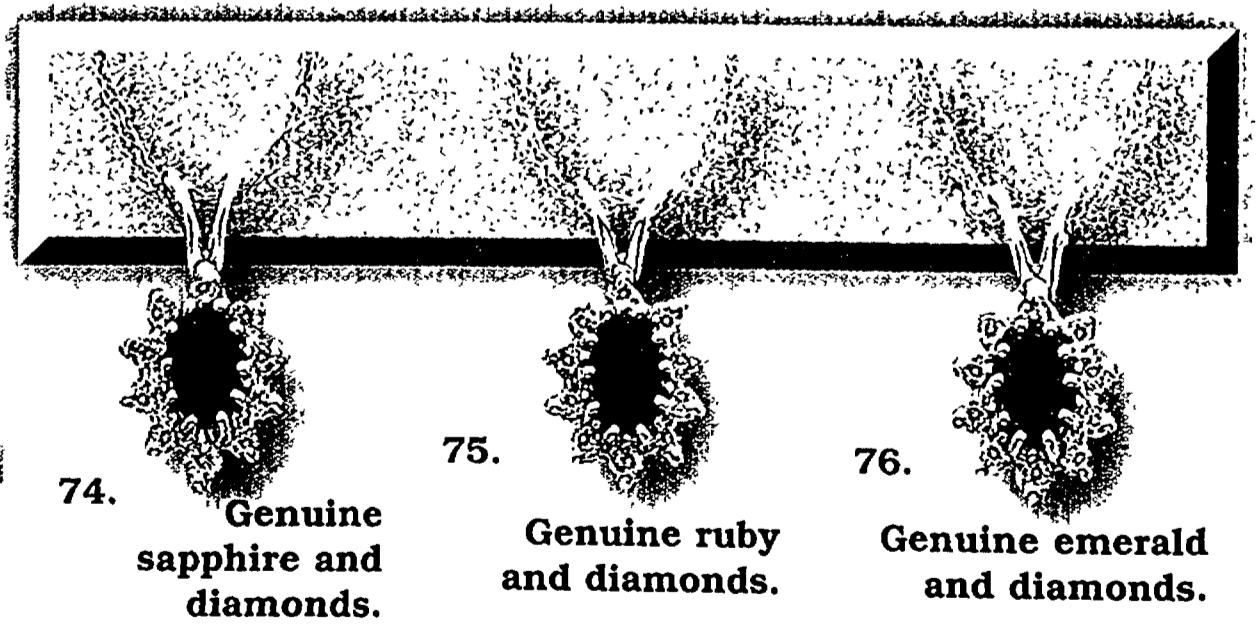

74. Genuine sapphire and diamonds.

75. Genuine ruby and diamonds.

76. Genuine emerald and diamonds.

**YOUR CHOICE \$249**

# COMES ONLY ONCE A YEAR



77. Diamond slide.  
**SALE \$249**  
Omega Chain Not Included

78. Diamond heart slide.  
**SALE \$1099**  
Omega Chain Not Included

As Low As \$25 Per Month\*

As Low As \$15 Per Month\*

79. Baguette diamond heart pendant.  
1/2 Carat t.w.  
**SALE \$499**

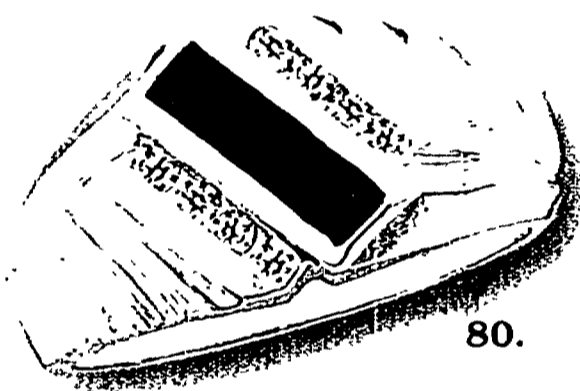
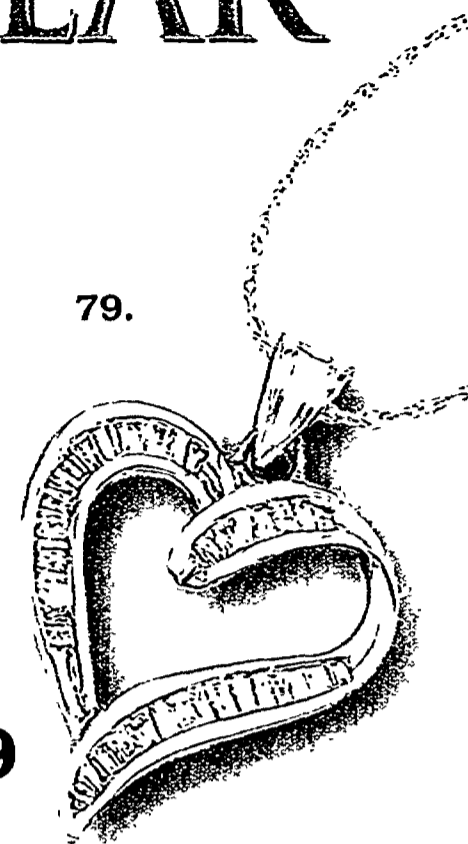

As Low As \$15 Per Month\*

80. Genuine sapphire and diamond men's ring.  
**SALE \$349**

**INSTANT CREDIT!**

**NO PAYMENTS NO INTEREST TILL 1997!\***



81. Gent's diamond ring.  
.50 Carat t.w.  
**SALE \$599**  
As Low As \$15 Per Month\*

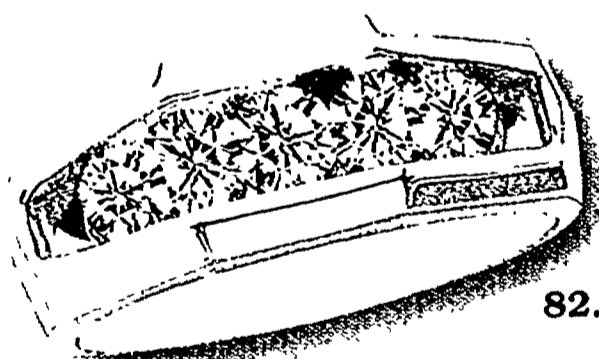

82. Five diamond gent's band.

**SALE**  
A. 1/3 Ct.t.w. \$599  
B. 1/2 Ct.t.w. \$899  
C. 1 Ct.t.w. \$1499



84. Comfort Fit™ diamond gent's band.  
**SALE \$499**  
As Low As \$15 Per Month\*

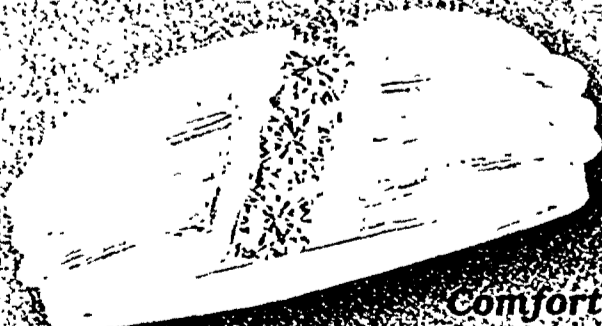

85. Comfort Fit™ diamond gent's band.  
**SALE \$599**  
As Low As \$15 Per Month\*

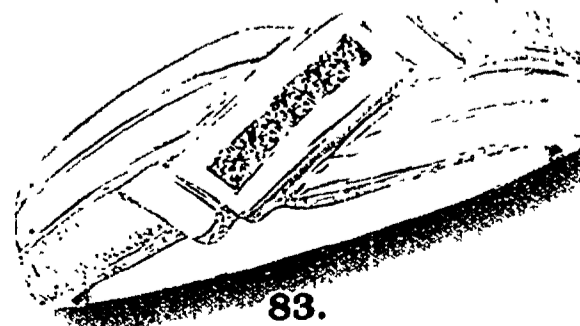

83. A handsome 4 diamond gent's band crafted in gold.  
**SALE \$249**

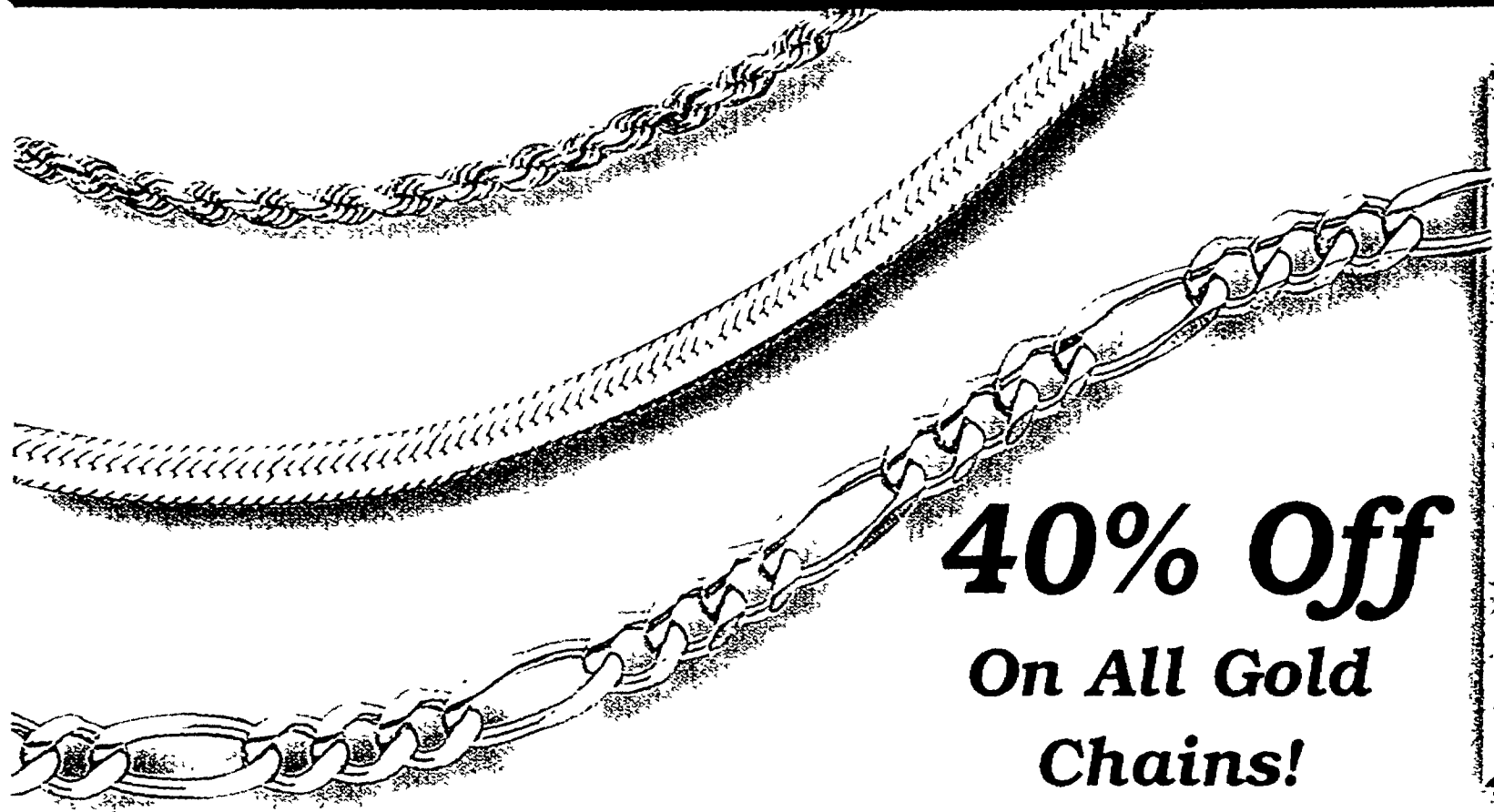

**40% Off**  
**On All Gold**  
**Chains!**

**14Kt. Gold Charms**

**From \$29<sup>99</sup>**

**Special Purchase!**

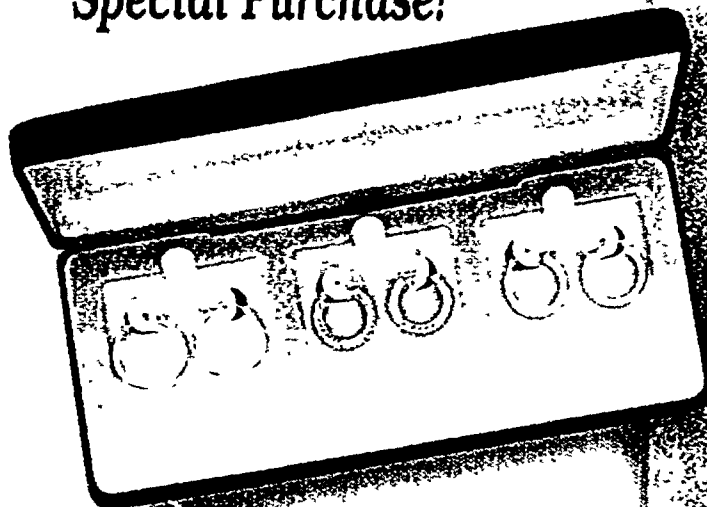

92. Gold hoop earring gift box set.  
**SALE \$99**

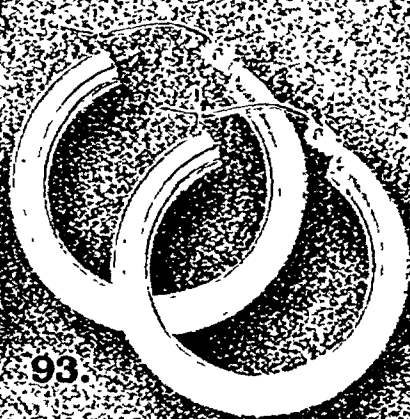

93. Polished 14K gold hoops  
**SALE \$49**



94. Cameo carved in gold  
**SALE \$79**

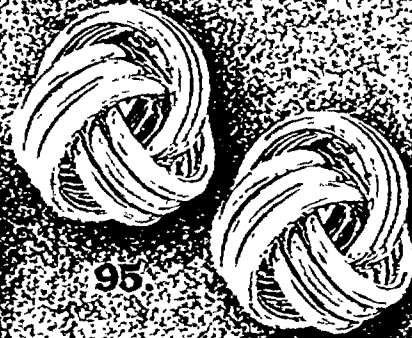

95. Love knots of 14K gold  
**SALE \$79**

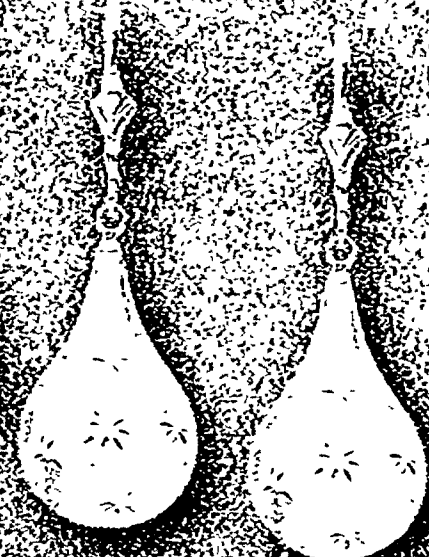

96. Euro-wire dangles.  
**SALE \$89**

**INSTANT CREDIT!**



**NO PAYMENTS**  
**NO INTEREST**  
**TILL 1997!\***

**Name Brand**  
**Watches**  
**Specially**  
**Priced At**  
**Meyer Jewelers**



97.

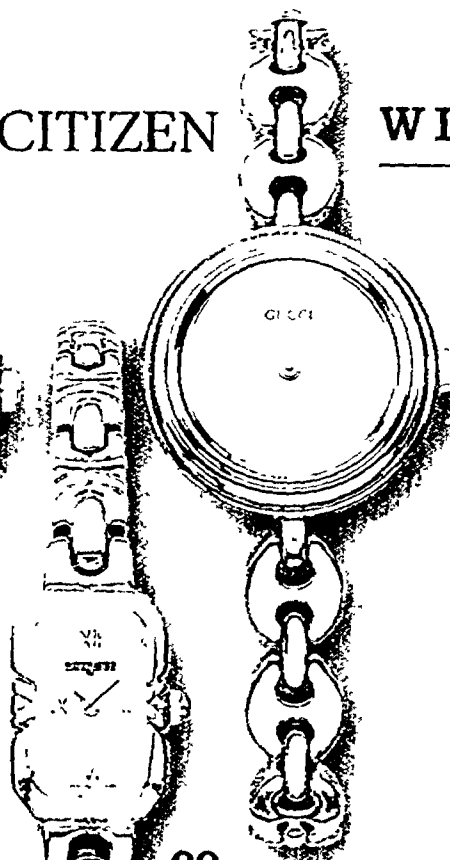

99.

**GUCCI**

98.

**WITNAUER**

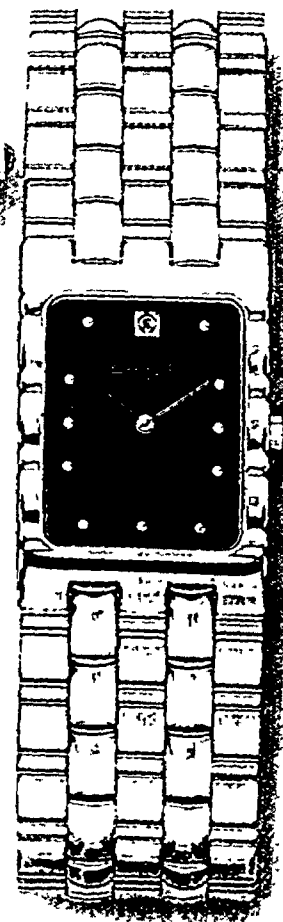

100.

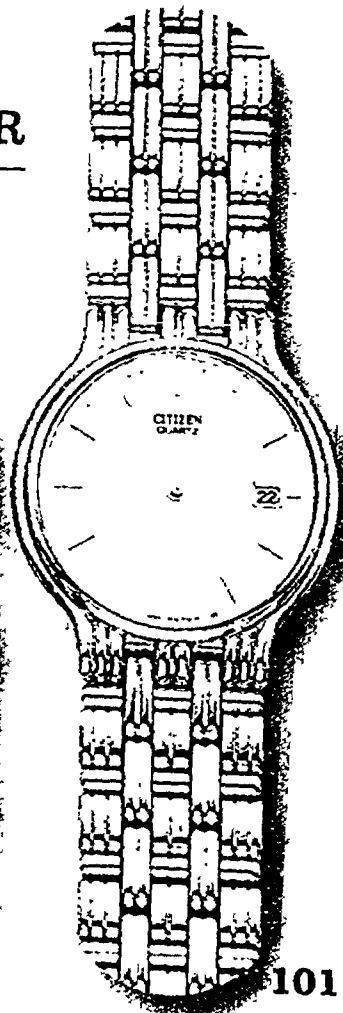

101.

**CITIZEN**

**14KT AND DIAMOND WATCHES**

102

**YOUR CHOICE \$799**

103.

**YOUR  
CHOICE  
\$49**



104. Gold heart and filigree ring.



105. Ruby and diamond ring.



106. Guardian angel and diamond ring.

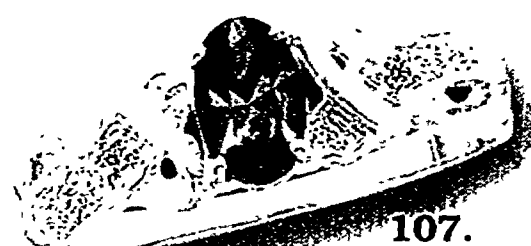

107. Blue topaz ring.

**YOUR  
CHOICE  
\$99**

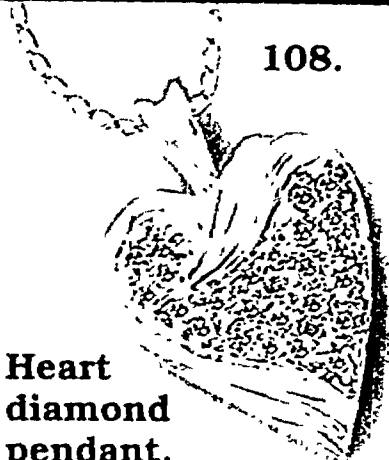

108. Heart diamond pendant.

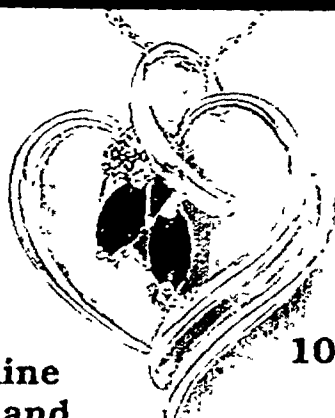

109. Genuine ruby and diamond pendant.

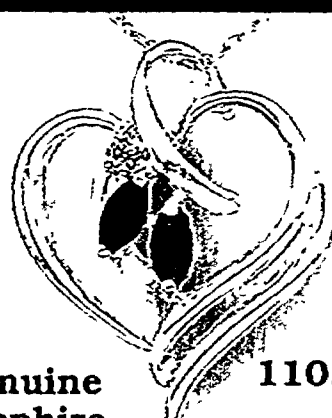

110. Genuine sapphire and diamond pendant.

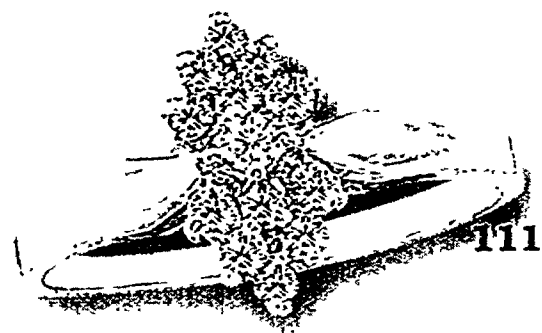

111. Diamond cluster

**YOUR  
CHOICE  
\$129**

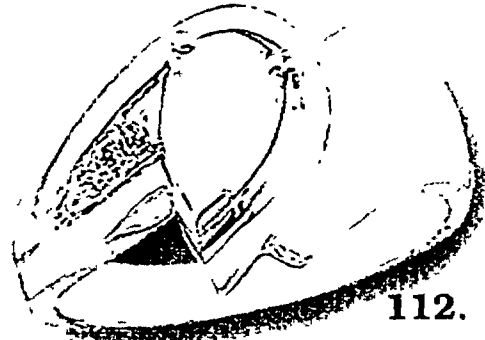

112. Opal and diamond.



113. Amethyst pendant.



114. Genuine sapphire and diamond pendant.

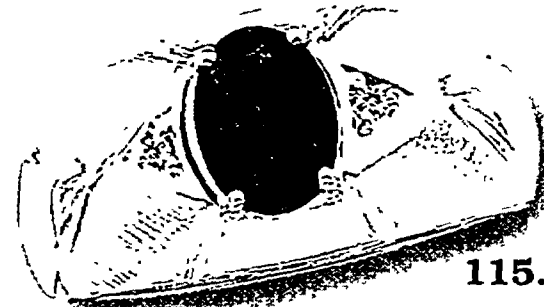

115. Men's garnet ring.

**YOUR  
CHOICE  
\$199**

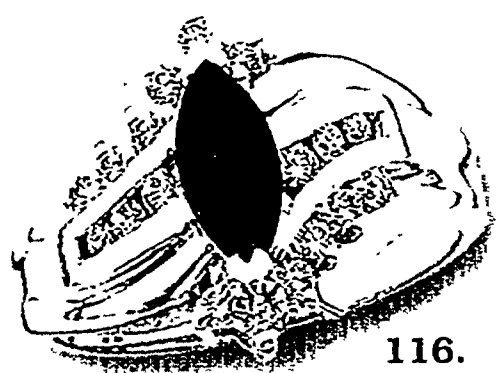

116. Sapphire and diamonds.



117. .25 Ct.t.w. Diamond ring.

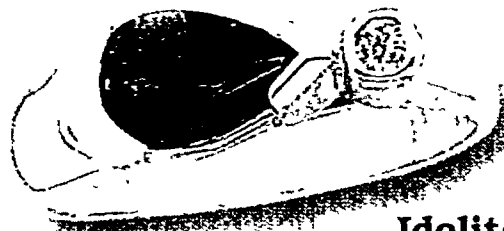

118. Idolite and diamond.



119. Diamond cross. .25 Ct.t.w.

**YOUR  
CHOICE  
\$299**

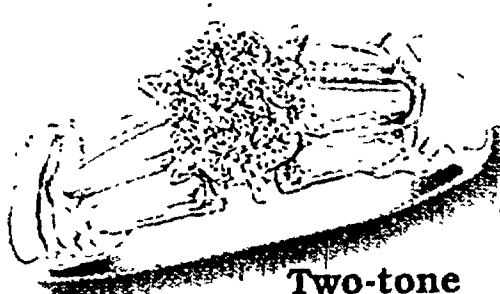

120. Two-tone diamond ring.

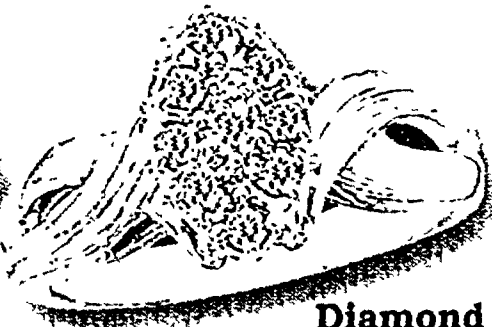

121. Diamond two-tone ring.

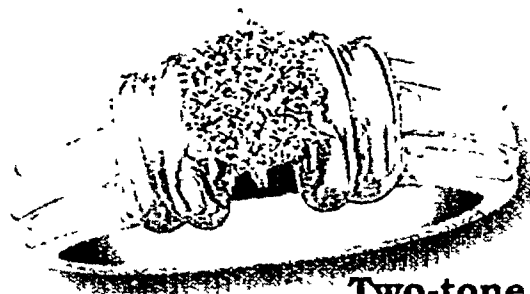

122. Two-tone diamond ring.

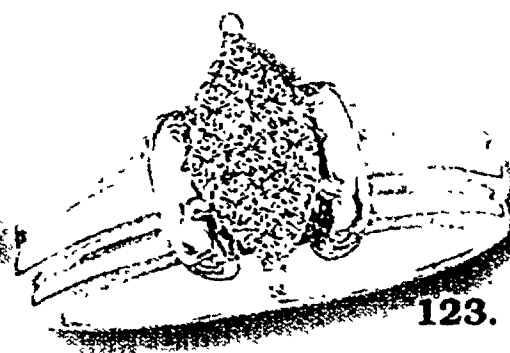

123. Diamond ring.

**YOUR  
CHOICE  
\$299**

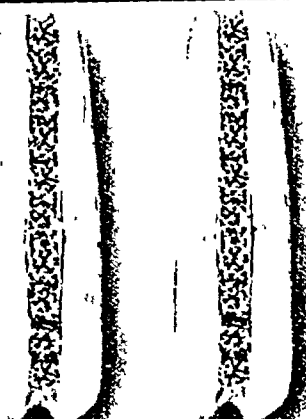

124. Diamond earrings. .50 Ct.t.w.



125. Genuine ruby and diamonds.



126. Genuine sapphire and diamonds.



127. Tanzanite and diamonds.

# INSTANT CREDIT!

Payments as  
Low as \$15  
Per Month



128.

1/2 Carat t.w.  
**SALE \$199**



129.

**SALE \$99**



130.

1 Carat t.w.  
**SALE \$299**



131.

2 Carat t.w.  
**SALE \$599**



132.

3 Carat t.w.  
**SALE \$999**

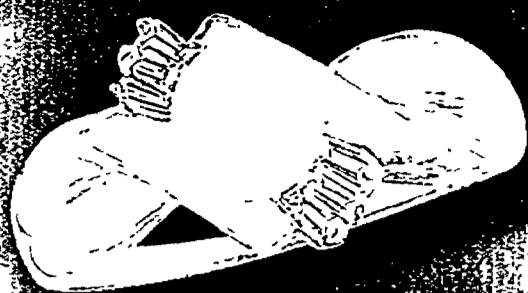

133. Pearl and baguette diamond ring.



134. Graceful diamond solitaire.

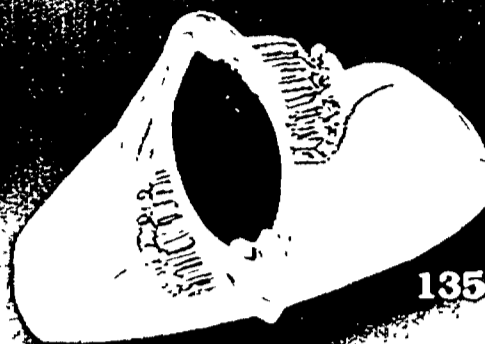

Genuine sapphire with baguette diamonds.

135.

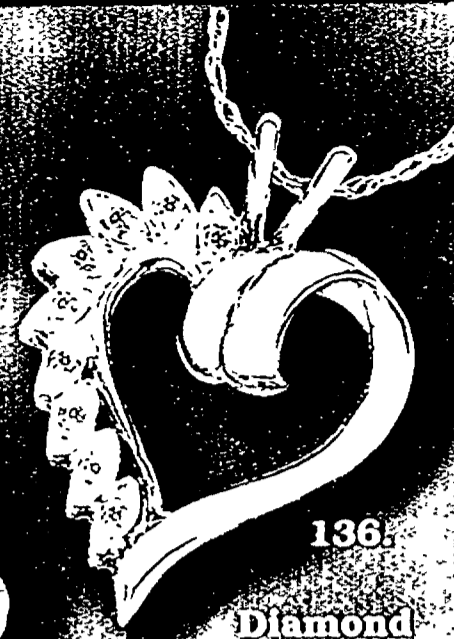

136. Diamond and gold heart.



Diamond anniversary necklace.

137.

**SALE**  
1/4 ct. **\$299**  
1/3 ct. **\$599**  
1/2 ct. **\$999**



138.

14Kt. Gold lady bug pendant.  
**SALE \$39<sup>90</sup>**



**INSTANT CREDIT!**  
**NO PAYMENTS**  
**NO INTEREST**  
**TILL 1997!\***

# Meyer Jewelers

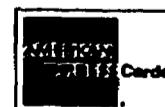

**ANN ARBOR**  
Briarwood Mall  
(313) 761-3315

**BATTLE CREEK**  
Lakeview Square Mall  
(616) 979-3370

**DEARBORN**  
Fairlane Town Center  
(313) 593-1440

**FLINT**  
Genesee Valley  
(810) 733-8641

**FORT GRATIOT**  
Birchwood Mall  
(810) 385-9690

**HARPER WOODS**  
Eastland Center  
(313) 245-9395

**KALAMAZOO**  
Crossroads Mall  
(616) 323-3633

**LINCOLN PARK**  
Lincoln Park Shopping Center  
(313) 381-9155

**LIVONIA**  
Wonderland Mall  
(313) 525-4232

**NOVI**  
Twelve Oaks Mall  
(810) 349-8010

**OKEMOS**  
Meridian Mall  
(517) 347-4111

**ROSEVILLE**  
Macomb Mall  
(810) 293-8110

**SOUTHFIELD**  
Tel-Twelve Mall  
(810) 356-3320

**STERLING HEIGHTS**  
Lakeside Center  
(810) 247-5500

**TAYLOR**  
Southland Center  
(313) 287-4250

**TRAVERSE CITY**  
Grand Traverse Mall  
(616) 946-1992

**TROY**  
Oakland Mall  
(810) 588-3805

**WESTLAND**  
Westland Center  
(313) 425-7676

Jewelry in this flyer may be enlarged to show beauty of detail. Ct.t.w. = Carat Total Weight. All carat weights are approximate. Merchandise may be limited and vary by store. Prices may vary due to fluctuations in the gold and diamond markets. Items in this flyer are also excluded from the Meyer Jewelers Trade-In program. Items in this flyer are also excluded from the Meyer Jewelers Lay-away program. We reserve the right to make corrections in typographical and printing errors.  
© Meyer Jewelers  
Sale Ends December 14, 1996

1996

**BUILDERS  
SQUARE**

We're open early  
**6 AM Friday &  
Saturday**



for great *Holiday Values*

ALL STORES ARE CLOSED  
THANKSGIVING DAY!

PRICES GOOD FRI., NOV. 29  
THRU TUES., DEC. 3, 1996.

6" Poinsettia  
**NOW: 3.44**  
WAS: 3.99



Art is representational.

All Christmas items are while quantities last. Limited to stock on hand...sorry, no rainchecks.

Fresh Cut  
**Christmas Trees**

Your Choice:  
Scotch Pine

**11.99**  
5'-7'

Douglas Fir

**19.99**  
6'-8'

Noble Fir

**26.99**  
6'-7'



150 Clear or Multi Colored  
Lights  
In Motion

**NOW: 6.87**  
WAS: 7.99

Assorted colors.  
#50070 or #50069



6 Pack/5 Lbs.  
Firelogs  
#05601

**8.92**  
**-1.50**

You pay  
Mrs. Mail-in  
Rebate

**7.42**

Your final cost

See store for details on mail-in rebate

WAS: 10.42

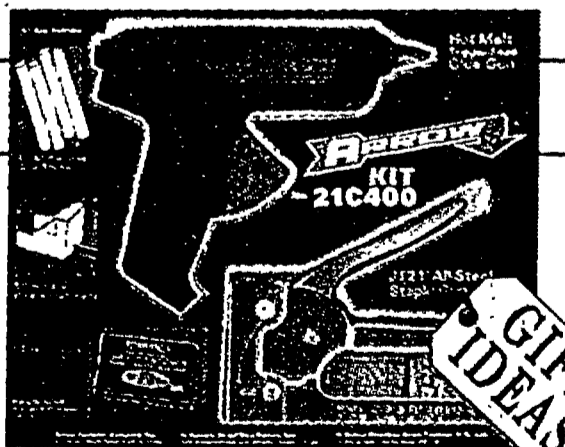

**Glue & Staple Gun Kit**

JT21\* staple gun.  
TR400 glue gun. 4  
glue sticks. Screen  
and wire attachment.  
1000-JT21\* staples.  
#21C400G

WAS: 19.98

**19.86**  
**NOW:**



**Tool Case**

Foam padded storage  
area helps protect tools.  
Lid has various storage  
compartments to orga-  
nize smaller parts. #7749

WAS: 14.97

**11.88**  
**NOW:**

See back cover for coupon SAVINGS OF \$5 TO \$50!

**SUPER SAVINGS ON POWERFUL GIFTS!**

# TRIM-A-TREE SAVINGS HEADQUARTERS!

**BIGGEST SPECIAL**

**FLAME RETARDANT**

**EASY TO ASSEMBLE**

**STAND INCLUDED**

**7' CAROLINA ARTIFICIAL FIR TREE**  
 Beautiful dark green 7' Carolina fir with 1396 tips & a 48" diameter at the bottom. Hand wrapped & hinged. Reusable box for storage. Flame retardant. Comes with its own stand. #DF8496N

**NOW ONLY \$69**  
 WAS \$79

## ALL ARTIFICIAL CHRISTMAS TREES ARE:

- Hand wrapped and hinged.
- Reusable box for storage.
- Comes with its own stand.
- Flame retardant.

### 4' IOWA PINE

#1G1W4002  
**19<sup>99</sup>**

### 6' NEW HAVEN PINE

#IGNHT6001  
**29<sup>99</sup>**

### 7' GREEN MOUNTAIN FIR

#CL8479N  
**\$99**

### 7-1/2' NOBLE FIR

#DJ9070N  
**\$129**

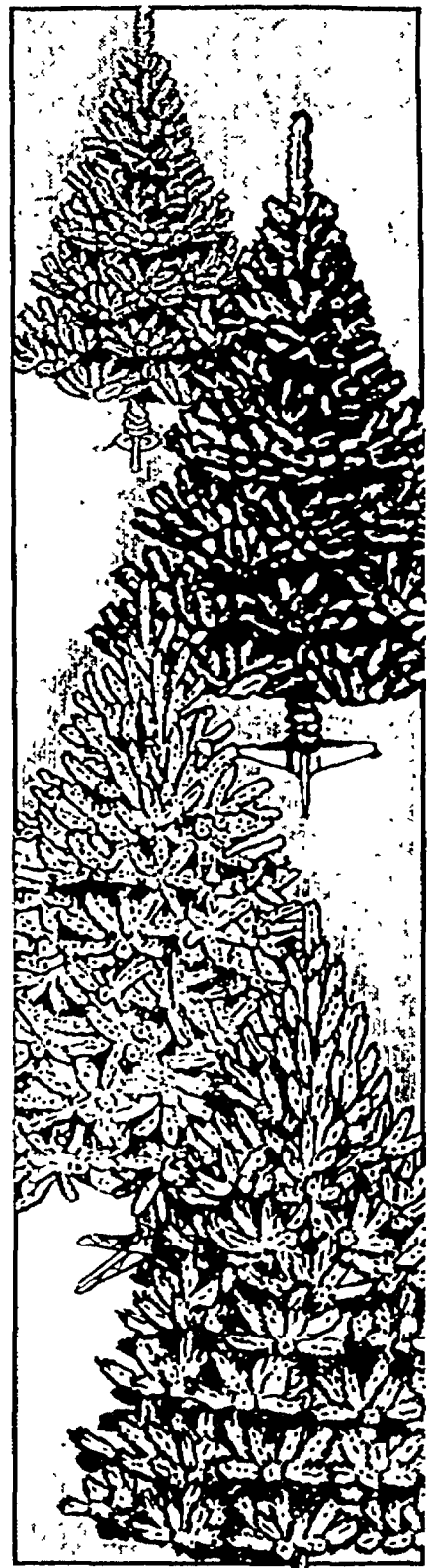

## Trims & more at low prices!

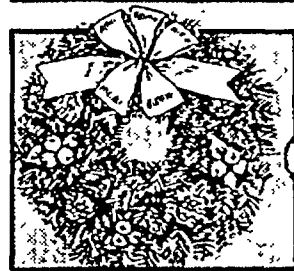

**20" DECORATED CHRISTMAS WREATH**  
 #WTP205N **9<sup>97</sup>**

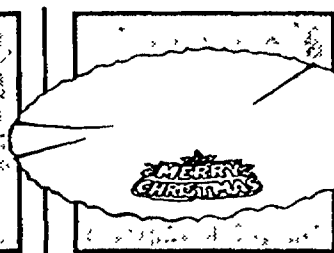

**50" SILHOUETTE TREE SKIRT**  
 #98512BS **13<sup>99</sup>**

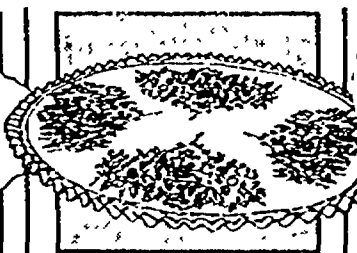

**64" CLASSIC TREE SKIRT**  
 #98513 **29<sup>99</sup>**

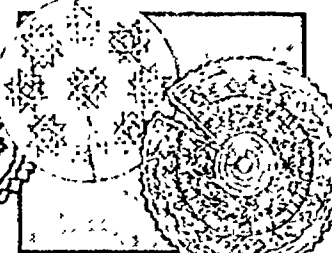

**56" OLD WORLD OR CROCHETED YOUR CHOICE! TREE SKIRT**  
 #1901004, #19810 **34<sup>99</sup>**



**13" HOME SPUN CHRISTMAS WREATH**  
 #X53386SW **9<sup>99</sup>** EACH



**10" ANGEL TREE TOPPER**  
 #50127 **8<sup>99</sup>**

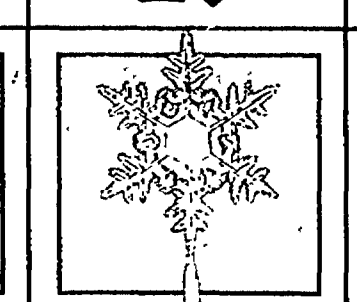

**12 LT. SNOW FLAKE TREE TOPPER**  
 #50128 **4<sup>99</sup>**

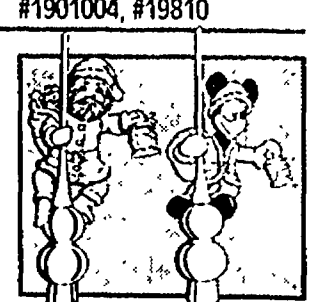

**SANTA OR MICKEY ANIMATED TREE TOPPER**  
 #49901, #49902 **21<sup>99</sup>** EACH

### TYPE III HOUSEHOLD ALUMINUM LADDER

200 lb. duty rating.

4'	#G708-04	'28
5'	#G708-05	31.17
6'	#G708-06	33.26

### TYPE III 4' APARTMENT PAINTERS LADDER

200 lb. duty rating.

**34<sup>31</sup>**  
 4' PLATFORM EURO LADDER #G566-04.....39.97

### TYPE A1 ALUMINUM MULTIMATIC LADDER

300 lb. duty rating. OSHA approved.

12'	#121482	'104
16'	#121499	'154

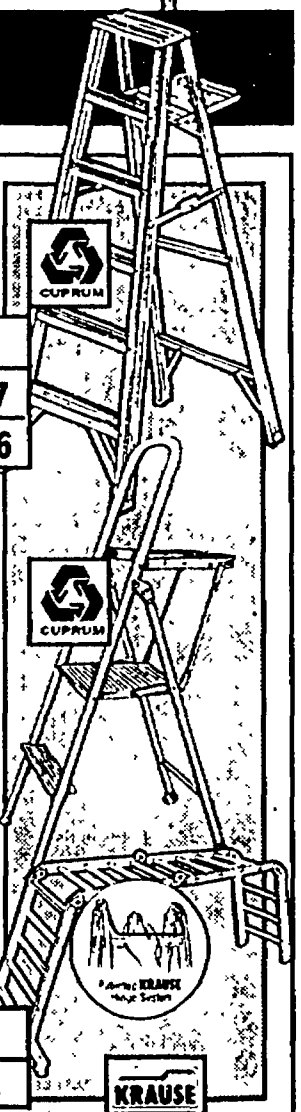

All Christmas items available while quantities last. Limited to stock on hand. Sorry, no rain checks.



# Celebrate & decorate!

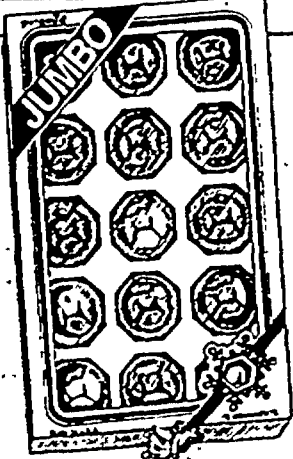

**SHINY GLASS ORNAMENTS**  
15-pack 2-1/4" or  
18-pack 1-3/4". Choose  
from assorted colors.

**2<sup>99</sup>**  
PER PACK #8061-01,  
#8061-5B,  
#8057-5B

**10-PC. NATIVITY SET**  
Battery operated with  
lights and music.

**14<sup>99</sup>**

#X-10649

**SANTA'S MUSICAL EXPRESS TRAIN SET**

Electronic music and  
sounds (music, bells,  
whistle and engine).  
Battery operated.  
#0174

**19<sup>99</sup>**

LOGGER BEAR'S MUSICAL  
EXPRESS HOLIDAY TRAIN  
#0181.....49.99

**SPECIAL**

**22" CHRISTMAS COUNTRY SQUARE BEAR**  
Your choice brown or  
white. Wears suspenders  
and plaid shirt.  
#X66452BU

**NOW ONLY 7<sup>96</sup>**  
**WAS 9<sup>99</sup>**

# Trim your tree with value!

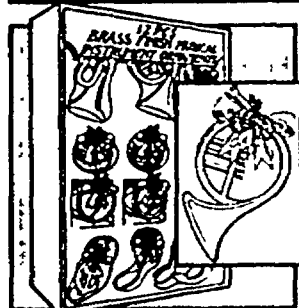

**12-PC. BRASS MUSIC ORNAMENTS**  
# U57136

**12<sup>99</sup>**

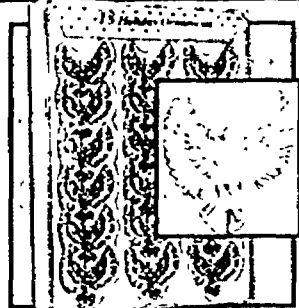

**18-PC. WHITE DOVE ORNAMENTS**  
# U57130

**19<sup>99</sup>**

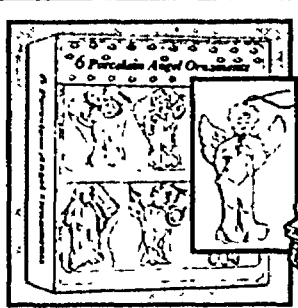

**6-PC. PORCELAIN ANGEL ORNAMENTS**  
# C31217

**18<sup>99</sup>**

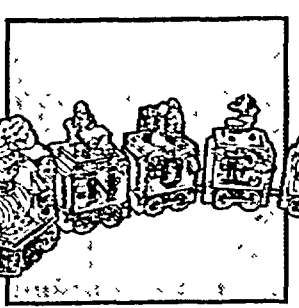

**LIGHTED PORCELAIN CHRISTMAS TRAIN**  
# S-11574

**34<sup>99</sup>**

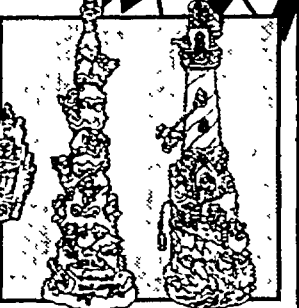

**15" LIGHTED/MUSICAL TREE OR LIGHTHOUSE**  
# X-10641, #X-10640

**19<sup>99</sup>**



**JADE PORCELAIN LIGHTED ANGEL**  
# S-11575C, # S-11575D

**17<sup>99</sup>**



**12-PC. CREAM/GOLD MUSIC ORNAMENTS**  
# U47145

**12<sup>99</sup>**



**9-PC. CARROUSEL HORSE ORNAMENTS**  
# C37212

**14<sup>97</sup>**

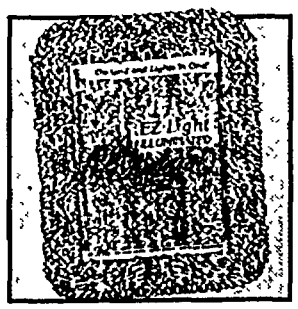

**EZ-ILLUMINATED PINE GARLAND**  
# 4346-611, # 4340-649

**19<sup>99</sup>**



**2" X 15' TIFFANY GARLAND ASSORTED COLORS**

**4<sup>99</sup>**



**BATTERY OPERATED MUSICAL SANTA HEAD**  
# X-30015

**9<sup>99</sup>**

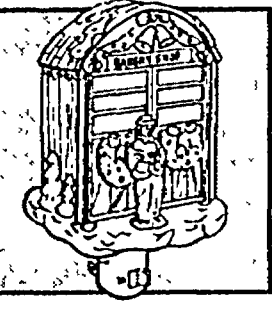

**PORCELAIN NIGHT LIGHT**  
# XPH-001

**3<sup>99</sup>**

**EXCEPTIONAL VALUES ON TRIM-A-TREE!**

**SUPER SAVINGS ON POWERFUL GIFTS!**

All Christmas items available while quantities last. Limited to stock on hand. Sorry, no rain checks.

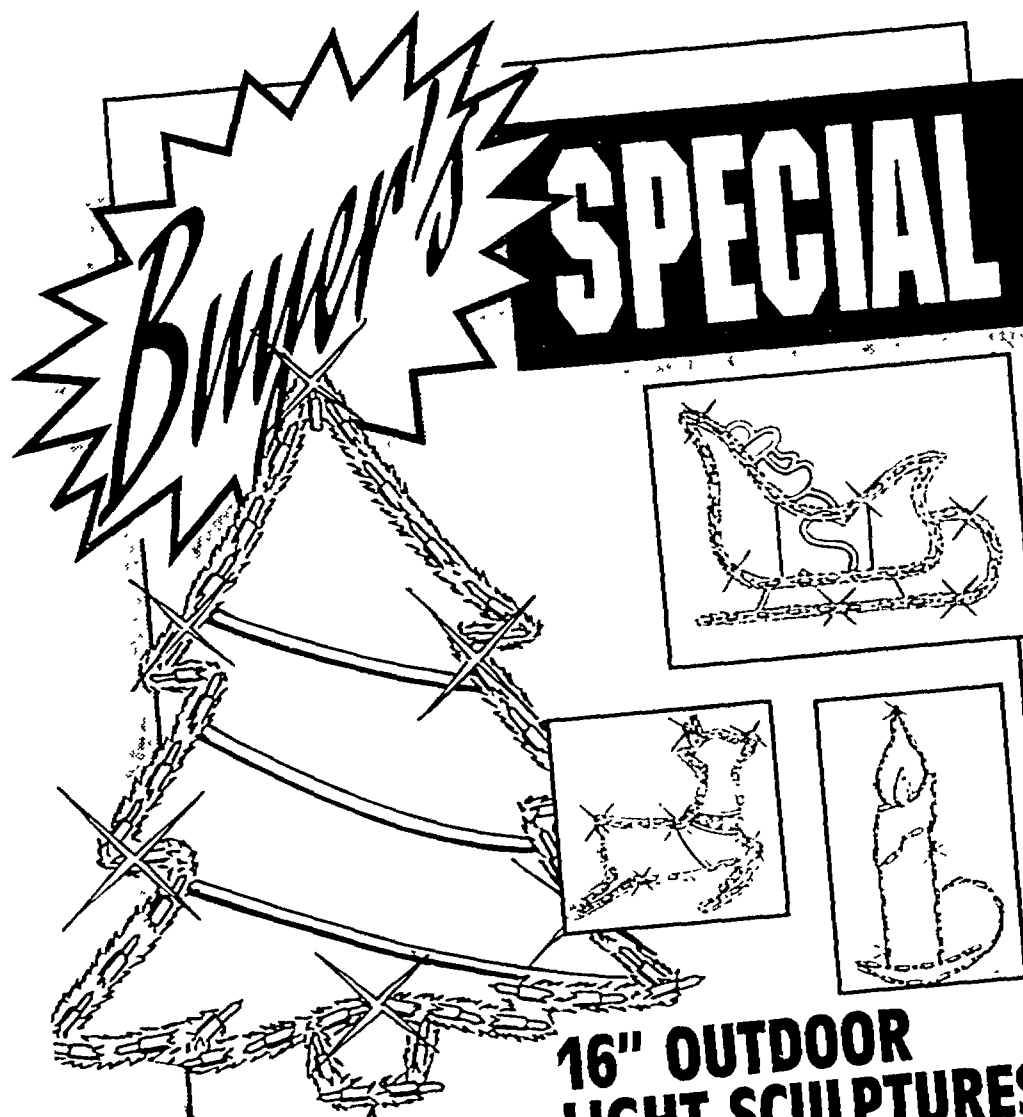

**16" OUTDOOR LIGHT SCULPTURES**

For window, wall or lawn.  
 CHOOSE FROM:  
 TREE #TW43, CANDLE #TW46,  
 REINDEER #TW50  
 OR SLEIGH #TW50

**NOW ONLY**  
**588**  
 WAS 6.99

**Outdoor light sculptures**

**MINI LIGHT SCULPTURES**

Indoor/outdoor. End to end connector. Sets up in seconds.  
 CHOOSE FROM:  
 WREATH #59818  
 CANDY CANE #59806  
 HO HO HO SANTA #59820, #59818, #59806

**19<sup>99</sup>**  
 EACH

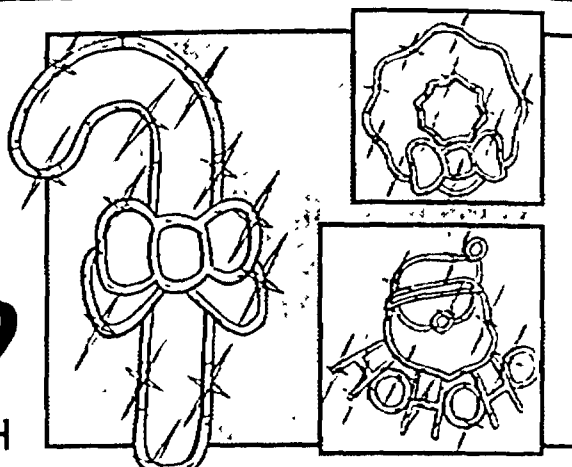

**50"/140 LIGHTS SCULPTURES**

Heavy gauge, coated steel frame. Pre-wired easy to assemble.  
 CHOOSE FROM:  
 SANTA #50080,  
 REINDEER #50076  
 OR SLEIGH #50077

**24<sup>99</sup>**  
 EACH

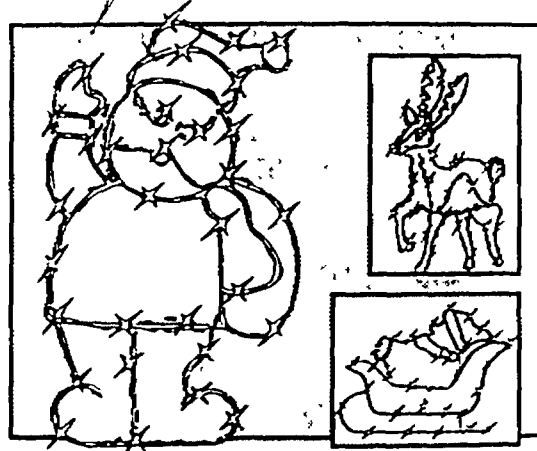

**22" LIGHTED SIGNS**

Indoor/outdoor. End to end connector. Sets up in seconds.  
 CHOOSE FROM:  
 FELIZ NAVIDAD #59704  
 OR MERRY CHRISTMAS #59703,

**39<sup>99</sup>**  
 EACH



**Lighted lawn sculptures at low prices.**

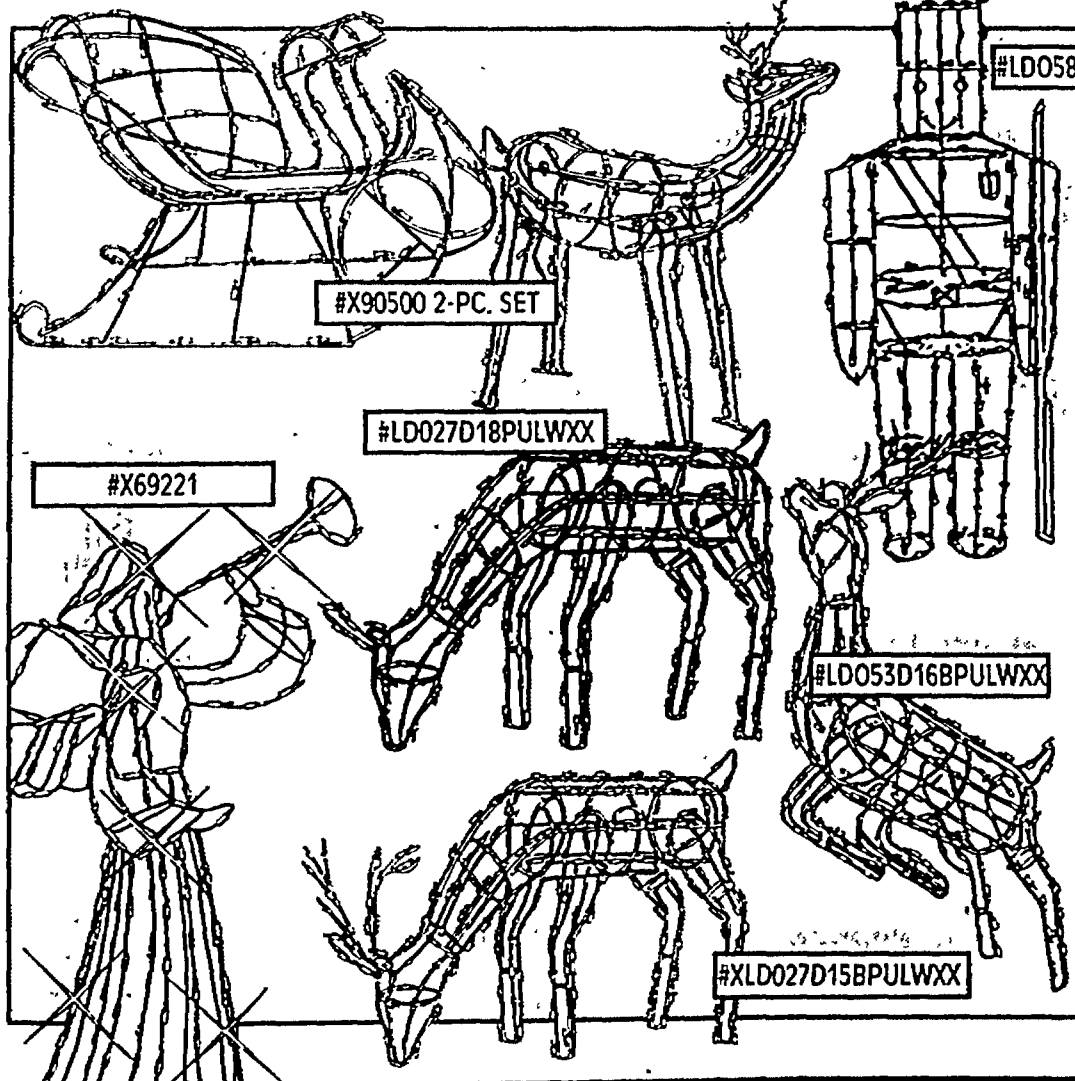

**3-D LIGHTED LAWN SCULPTURES**

<b>30" REINDEER</b>	#X30501	<b>39.99</b>
<b>42" ANGEL</b>	#X42502	<b>39.99</b>
<b>FEEDING BUCK</b> SHOWN	#XLD027D15BPULWXX	<b>79.99</b>
<b>2-PC. SLED &amp; DEER</b> SHOWN	#X90500	<b>79.99</b>
<b>REINDEER</b>	#X54220	<b>89.99</b>
<b>JUMPING DEER</b> SHOWN	#LD053D16BPULWXX	<b>79.99</b>
<b>FEEDING DOE</b> SHOWN	#LD027D18BPULWXX	<b>79.99</b>
<b>TOY SOLDIER</b> SHOWN	#LD058D09BPULWXX	<b>89.99</b>
<b>30" LARGE SLED</b>	#X77222	<b>99.99</b>
<b>ANGEL</b> SHOWN	#X69221	<b>99.99</b>

All Christmas items available while quantities last. Limited to stock on hand. Sorry, no rain checks.

# Charming holiday scenery



## 4-PC. 28" ILLUMINATED NATIVITY SET

28" in size. Marble look with matte finish. #1568

**49<sup>99</sup>**

4-PIECE SET

## 3-PC. 36" ILLUMINATED WISE MEN SET

Illuminated for outdoor use. 3 piece set. #1369

**69<sup>99</sup>**

3-PIECE SET



## 3-PC. 18" CHILD NATIVITY SET

Features Mary, Joseph and Baby Jesus. #1468

**34<sup>99</sup>**



## 4-PC. 28" ILLUMINATED NATIVITY SET

28" in size. INCLUDES: Mary, Joseph and baby Jesus. #1476

NOW ONLY

**39<sup>88</sup>**

WAS 49<sup>99</sup>

# BIG decorating ideas at LITTLE prices.

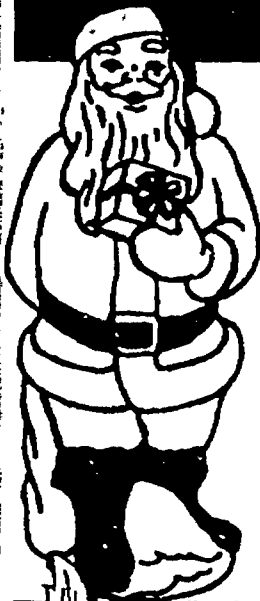

## 34" ILLUMINATED SANTA WITH WRAPPED GIFT

#1534

**21<sup>99</sup>**



## 48" ILLUMINATED REINDEER

#61745

**42<sup>99</sup>**

## 72" ILLUMINATED SANTA-SLEIGH-REINDEER

#1648

**79<sup>99</sup>**



TIER #LX19610T25



COMBO #LX10610T25



FLOOD #LX90610T25

PERFECT FOR USE WITH CHRISTMAS TOPPERS!

YOUR CHOICE!

**\$44**

## INTERMATIC MALIBU

STANDARD SERIES/10-LT SETS  
Safe to install & uses only 12 volts of electricity. Most installations can be done in less in 1 hour.

DECORATIVE COLORED BULB COVERS  
Choose from:  
Multi-Pack #LV281M  
Blue #LV281B, Amber #LV281A  
Red #LV281R, Green #LV281G

**3<sup>99</sup>**  
EACH



## 40" ILLUMINATED NOEL CHRISTMAS CANDLE

#1503

**9<sup>99</sup>**



## 34" ILLUMINATED SNOWMAN WITH CANDY CANE

#1529

**21<sup>99</sup>**



## ASSORTED STYLE CHRISTMAS TOPPERS

Each topper attaches to a low voltage exterior light. #1468

**3<sup>99</sup>**  
EACH

All Christmas items available while quantities last. Limited to stock on hand. Sorry, no rain checks.

**SUPER SAVINGS ON POWERFUL GIFTS!**

Enjoy the magic of animation.

**SPECIAL**



**18" ANIMATED SANTA, MRS. SANTA, OR ANGEL**  
 Arm motion. With lit candle.  
 #31801, #31805, #31802

**19<sup>97</sup>**  
 YOUR CHOICE

**18" ANIMATED SANTA, MRS. SANTA, OR ANGEL WITH MUSIC**  
 Battery operated. With lit candle.  
 #XAF-013, #XAF-015, #XAF-017

**NOW ONLY 9<sup>98</sup>**  
 WAS 12<sup>99</sup>

**21" ANIMATED SLEEPING CHILD IN ROCKING CHAIR**  
 Real rocking motion.  
 #A22146

**\$39**

**ANIMATED SNOW WHITE 21" SANTA WITH SILVER & WHITE TOY BAG**  
**24" MRS. SANTA WITH GIFTS & CANDLE**  
**24" BEAR WITH TOP HAT & SCARF**  
 Authentic character moving head.  
 #A25123, #A25124, #A25127

**49<sup>99</sup>**  
 YOUR CHOICE



**MUSICAL HOLIDAY MERRY GO ROUND**  
 6 Carousel figures ride continuously to music and lights. 21 carols play as it turns. Indoor use only.  
 #29601

**89<sup>97</sup>**

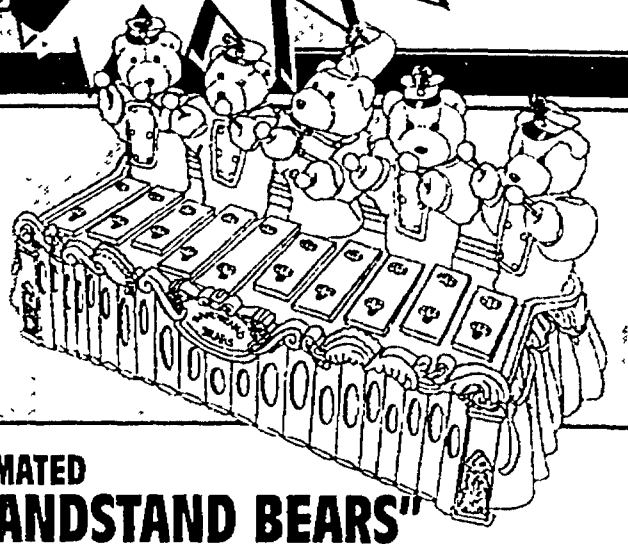

**ANIMATED "BANDSTAND BEARS"**  
 5 animated teddy bears play 35 Christmas carols on a real xylophone. #29401

**\$79**

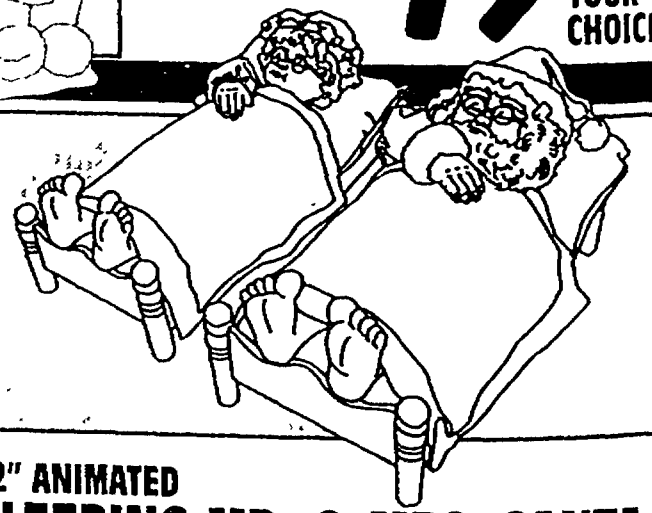

**12" ANIMATED SLEEPING MR. & MRS. SANTA**  
 Battery operated. Listen as Mr. & Mrs. Santa sleep, snore and whistle to the tune of "Jingle Bells".  
 #52017

**19<sup>99</sup>**



**23" ANIMATED SANTA WITH REINDEER & SLEIGH**  
 Waving Santa with glowing lantern and moving reindeer.  
 #6701073

**84<sup>99</sup>**

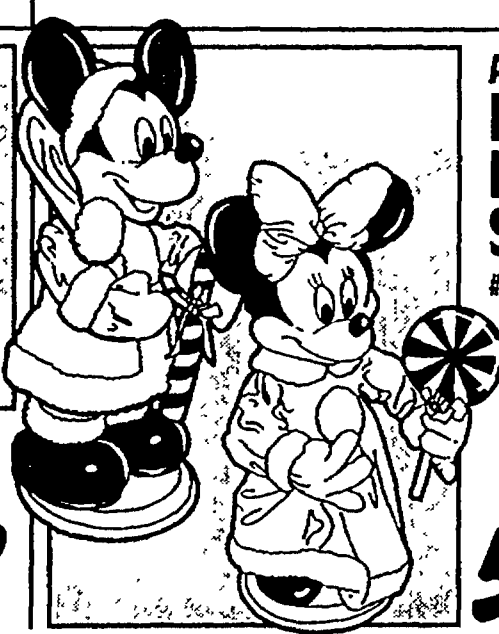

**ANIMATED MICKEY & MINNIE SANTA**  
 #6701705  
 YOUR CHOICE

**59<sup>99</sup> EACH**



**18" ANIMATED TASMANIAN DEVIL**  
 Plugs into 110 voltage. Indoor use only. Arms move up and down. Taz is complete with candy canes in hand and a present in mouth. #9600817

**59<sup>99</sup>**

All Christmas items available while quantities last. Limited to stock on hand. Sorry, no rain checks.

# Holiday value and variety

## 100 COMMERCIAL 2-WAY LIGHT SET

Available in multi or clear.  
Indoor/outdoor. #CDL2-100A,  
#CDL2-100CL

**9.99** YOU PAY

**-4.00** MFG. MAIL-IN-REBATE

**5.99** YOUR FINAL COST

**75 LIGHTS CLEAR**  
#CDL2-75CL

**8.99** AFTER \$2 MFG. MAIL-IN-REBATE

## 150 LITE MUSICAL CHASER

Available in multi or clear.  
For indoor use only. Harmonic speaker, 3 volume levels. Random flashing. Steady burning. UL listed.

#RL-1504-RX015M,  
#RL-1504-RX015C

**9.99**

## 200 LITE 2 WAY SET

Available in multi or clear.  
Indoor/outdoor. Total length 45 ft. Flashing or non flashing. Guaranteed to light. UL listed.

#C2/1002FEC

**5.99**

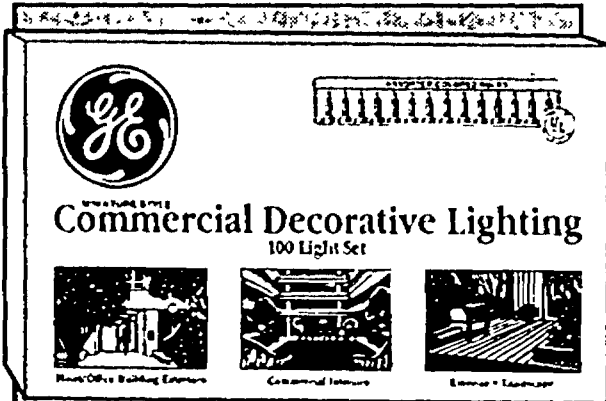

**Commercial Decorative Lighting**  
100 Light Set

Multi-Office Building Entrance Commercial Interior Entrance + Landscape

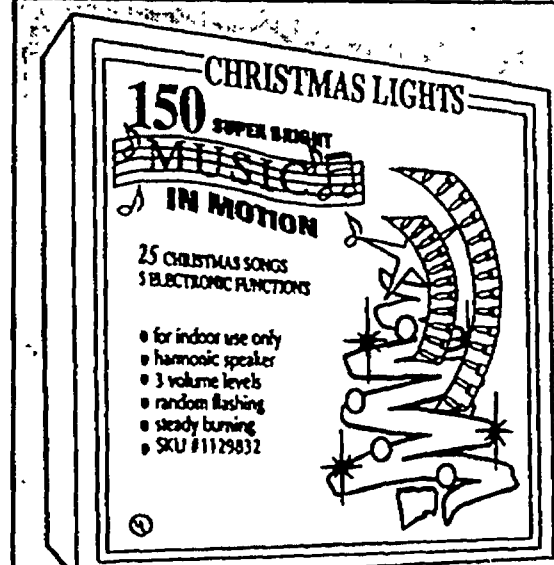

**150 SUPER BRIGHT MUSIC IN MOTION**  
CHRISTMAS LIGHTS

25 CHRISTMAS SONGS 3 ELECTRONIC FUNCTIONS

- for indoor use only
- harmonic speaker
- 3 volume levels
- random flashing
- steady burning
- SKU #1129832

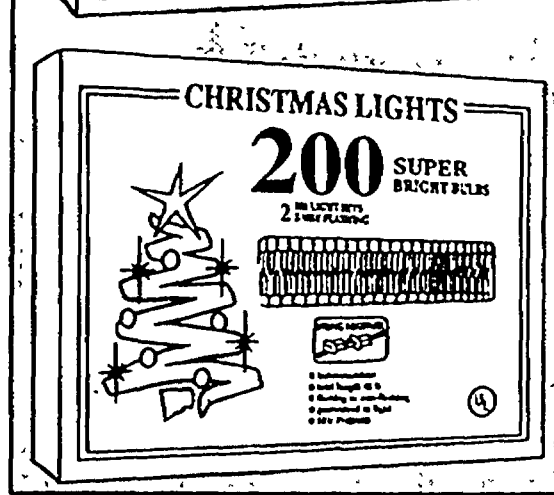

**200 SUPER BRIGHT BULBS**  
CHRISTMAS LIGHTS

2 IN LIGHTS SETS 2-WAY FLASHING

- Guaranteed to light
- Flashing or non-flashing
- UL listed
- SKU #1129832

**BIG SPECIAL**



**100 SUPER BRIGHT 2-WAY LIGHT SET**  
CHRISTMAS LIGHTS

Available in red, multi, blue, green or clear.  
Indoor/outdoor. Total length 45 ft. Flashing or non-flashing.

#TW100-2F-R/M/B/G/C

**NOW ONLY 2.66**  
WAS 2.89

## Money saving ways to make your home merry and bright!



**25 INDOOR/OUTDOOR C-7 LIGHTS**  
CHRISTMAS LIGHTS

**REPLACEMENT BULBS**  
C-7 C-9

**79¢ 99¢**

#5007, #5006 #50018 #50050 #50010 #50012



**25 INDOOR/OUTDOOR C-9 LIGHTS**  
CHRISTMAS LIGHTS

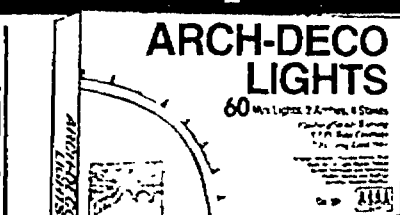

**ARCH-DECO LIGHTS**  
60 mini lights, 3 arches and 4 stakes.



**7 BUBBLE LIGHT SET**  
CHRISTMAS LIGHTS



**9" CANDLE**  
Battery operated  
#C-9-01

**25 INDOOR/OUTDOOR C-7 LIGHTS**  
Available in multi, clear or multi-trans. UL listed.

#50005, #50006, #50026

**7.99**

**25 INDOOR/OUTDOOR C-9 LIGHTS**  
Available in multi, clear, multi-trans, blue or red. UL listed.

#50003, #50004, #50025, #50021, #50020

**7.99**

**CLEAR ARCH-DECO LIGHTS**  
60 mini lights, 3 arches and 4 stakes.

**100 LIGHTS**  
#AD100/CC-8M 19.99

**14.99**

**7 BUBBLE LIGHT SET**  
Plugs at both ends for continuous lighting. Full bubbling action. #C77-F56

**9.99**

**9" CANDLE**  
Battery operated  
#C-9-01

**1.99**

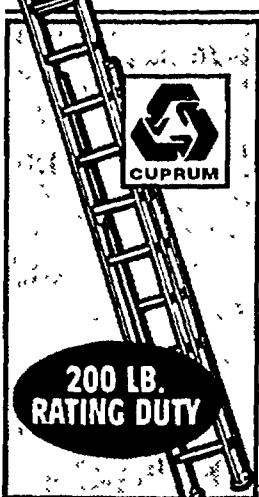

**TYPE III 16 FOOT ALUMINUM EXTENSION LADDER**  
#G554-16

**41.99**

20' #G385-20 \$79  
24' #G385-24 99.98

200 LB. RATING DUTY



**TYPE I 16 FOOT FIBERGLASS INDUSTRIAL LADDER**  
#G578-16

**144.87**

20' #G578-20 183.70  
24' #G534-24 224.25  
28' #G534-28 258.10

250 LB. RATING DUTY

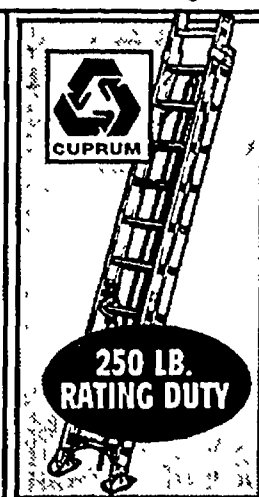

**13 FOOT STEEL ADJUSTABLE FOLDING LADDER**  
#13051

May be used as step overhang or scaffold ladder

**99.97**

17' #17651 \$131

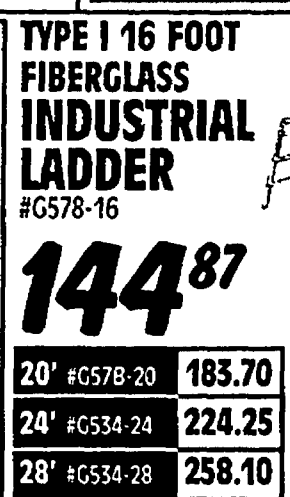

**13 FOOT ALUMINUM FOLDING LADDER**  
#13093

Multi-purpose, heavy duty folding ladder

**138.06**

17' #17693 \$157

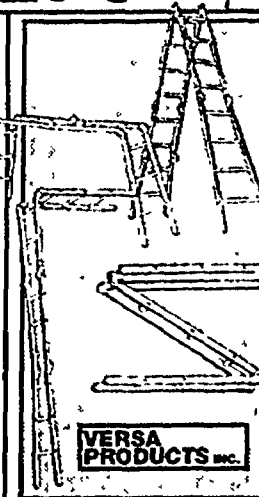

**VERSAPRODUCTS**



**VERSAPRODUCTS**

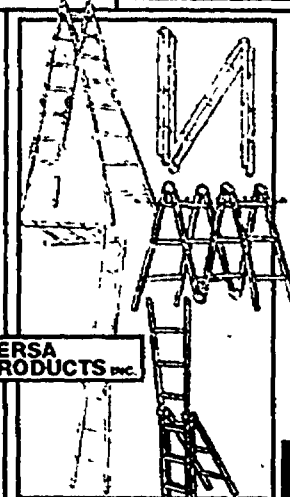

**VERSAPRODUCTS**



**VERSAPRODUCTS**

All Christmas items available while quantities last. Limited to stock on hand. Sorry, no rain checks.

**SUPER SAVINGS ON POWERFUL GIFTS!**

# Bumper HOLIDAY SPECIALS

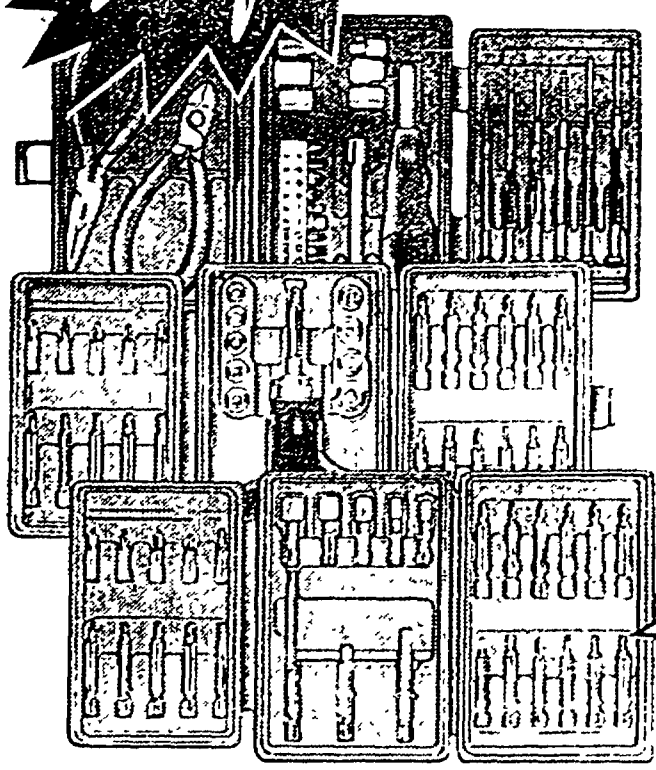

## OLYMPIA

25 PC. MINI TOOL SET, #90-325  
 34 PC. BIT SOCKET SET, OR #29-334  
 31 PC. POWER BIT SET #29-351

**9.97**  
 YOUR CHOICE

Receive a \$15 Builders Square gift certificate from Stanley with the purchase of \$50 of Stanley tools! Expires 12-31-96 See store for details on mail-in offer!

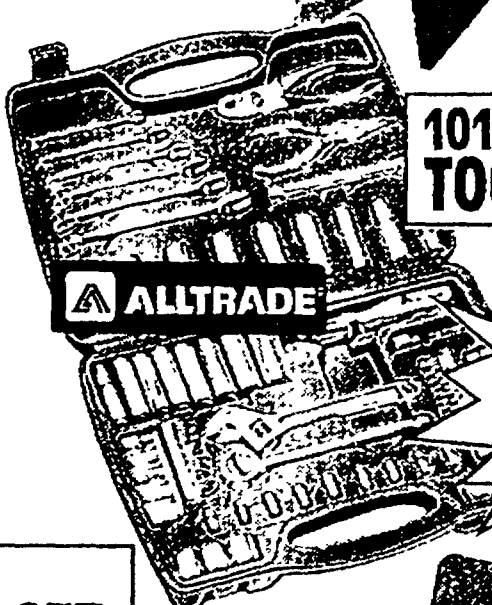

101 PC. MECHANICS TOOL SET

ALLTRADE

**39.88**  
 #436-T-101



## ALLTRADE

10 PC. SCREWDRIVER SET, 5 PC. PLIER/CRIMP SET, 12 PC. SAE WRENCH SET, OR 6 PC. HOME AND AUTO TOOL SET

**14.94**  
 YOUR CHOICE

#400002, 400005, 400006, 400009



17 PC. HOME PROJECT TOOL SET

STANLEY

GIFT IDEAS

**29.98**  
 #92-677

## Affordable ways to stuff a stocking with goodies.

**STANLEY**  
**99™ UTILITY KNIFE**  
 Includes three blades.  
**3.15** RETRACTABLE BLADE  
 #10-099

**STANLEY**  
**POWERLOCK TAPE RULE**  
 Power return.  
**9.97** 1" x 25'  
 #33-425L

**STANLEY**  
**6PC. THRIFTY SCREWDRIVER SET**  
**4.77** SIX POPULAR SCREWDRIVERS  
 #64-457

**md**  
**CARPENTER'S SUPER SQUARE**  
 For indicating angle cuts.  
**5.79**  
 #27318

**BLACK & DECKER**  
**POWER SHOT STAPLER**  
 Fires full range of staples.  
**19.99**  
 #5700F10

# HOLIDAY SPECIALS

SUPER SAVINGS ON POWERFUL GIFTS!



**QUICK-GRIP  
SPRING CLAMP**

1" 25MM	1.97
2" 50MM	2.47
3" 75MM	3.97

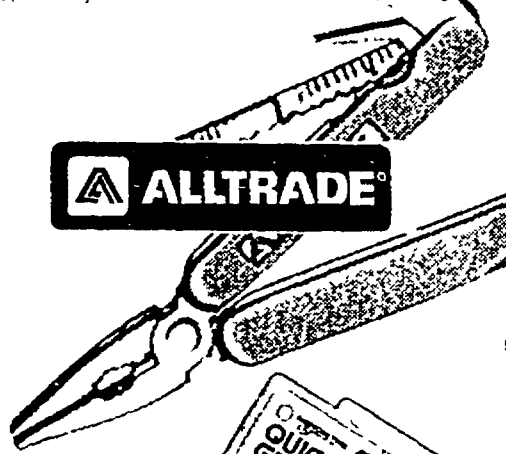

**12-IN-1 DELUXE  
POCKET TOOL**

**7.99**

#170050



**PREMIUM POWER  
TOOL BOX**  
With 4-120v grounded outlets.

**\$29**

#9000



**6" MINI QUICK GRIP  
BAR CLAMP**  
Ideal for clamping small jobs.

**19.98**

#54620

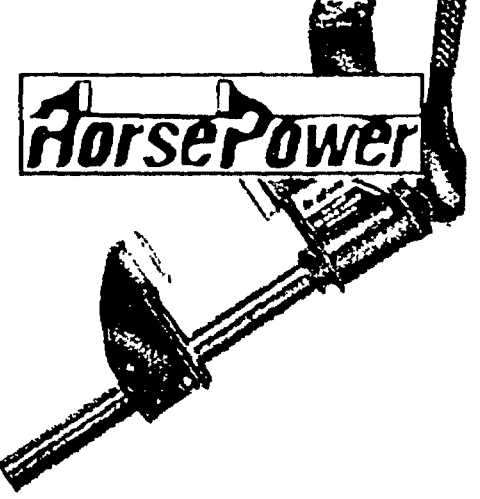

**HORSEPOWER  
HANDY CLAMP**  
Jaw rotate 180° for versatility.

**14.88**

#570L3

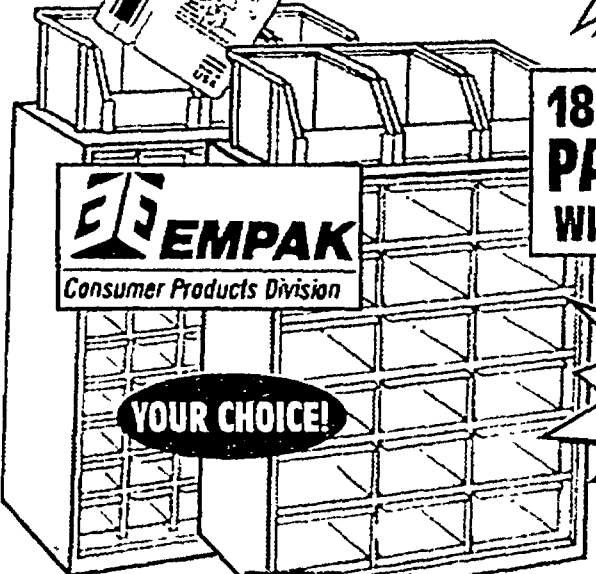

**18 OR 60 DRAWER  
PARTS ORGANIZER  
WITH 3 FREE BINS**

**14.94** EACH

#C8160/C8448-01

**BOSS 48"  
LEVEL WITH CASE**  
Rigid aluminum I-beam frame.



**17.77**

#59068-36

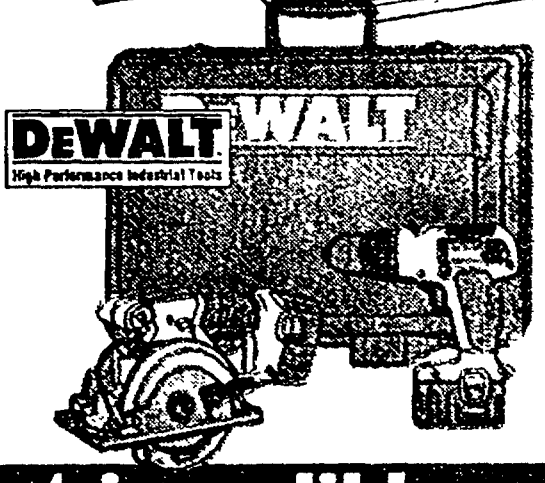

**14.4V HEAVY DUTY CORDLESS SAW &  
DRILL COMBO PACK**

**\$347**

#DW991KS-2

**Incredible selection at incredible savings!**

**WELLS LAMONT**

**MENS LEATHER PALM  
GLOVE**

**3.11**

LARGE  
#4000

**IRWIN**

**100'  
CHALK/REEL  
COMBO**

4 oz. blue chalk

**4.64**

#64499

**10 POCKET  
CONSTRUCTION  
APRON**

Split leather.

**13.16**

#1R-499-2

**ZIRCON**

**ELECTRIC AUTOMATIC  
STUDSENSOR**

SELF-CALIBRATING.

**13.99**

#SS9434

**JobBoss**

**44 POCKET  
BUCKET MOUNTED  
TOOL  
CARRIER**

**13.68**

#770471002

BUCKET SOLD SEPARATELY!

**Bumper's**

# HOLIDAY SPECIALS



**18 VOLT EXTREME DEWALT CORDLESS DRILL KIT**  
With a charger, XR PACK® battery, and carrying case. #DW995K

**\$239**

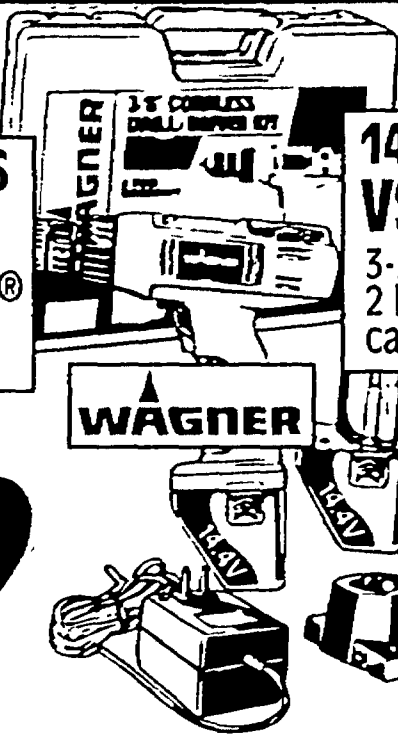

**14.4 V CORDLESS VSR DRILL KIT**  
3-hour battery charger, 2 batteries and carrying case. #WB144K-2

**\$99<sup>96</sup>**



**12 V WARRIOR VSR DRILL**  
"T" handle design, case and two 12v batteries. #2480-04

**\$89**

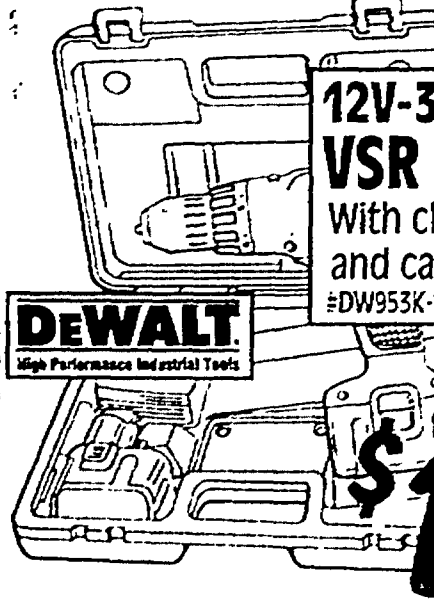

**12V-3/8" CORDLESS VSR DRILL KIT**  
With charger, 2 batteries and carrying case. #DW953K-2

**\$159**



**6.0V CORDLESS DRILL KIT**  
With case and 35 bit tip accessories. #9049KB

**\$39<sup>94</sup>**



**VERSAPAK COMBO KIT**  
With 3.6v cordless screwdriver, Snakelight™ and VersaPak battery and charger starter kit. #VPSNSD

**\$49<sup>97</sup>**

**Don't see the drill you want? Come see us for more choices.**



**14.4V-3/8" CORDLESS VSR DRILL KIT** #DW991K-2

**\$229**



**9.6V CORDLESS VSR DRILL KIT** #6221DWE  
Keyless chuck

**\$109<sup>96</sup>** ~~12V 179.97~~



**14.4V CORDLESS VSR DRILL KIT** #3610K

**\$199**



**14.4V CORDLESS VSR DRILL KIT** #CTH1442K  
Keyless chuck

**\$159**



**9.6V-3/8" CORDLESS VSR DRILL KIT** #DW952K-2

**\$127<sup>97</sup>**



**3/8" CORDLESS VSR DRILL**  
With extra battery. #6095DWE

**\$129<sup>96</sup>**

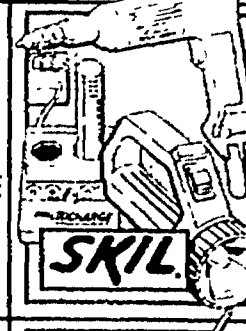

**7.2V CORDLESS DRILL WITH BONUS FLASHLIGHT** #2236-12

**\$46<sup>99</sup>**



**9.6V-3/8" CORDLESS VSR DRILL KIT** #CTH962K

**\$109**



**CORDLESS SCREWDRIVER**  
Narrow nose piece for tight places. #9072

**\$19<sup>97</sup>**



**7.2V-3/8" CORDLESS VSR DRILL KIT** #6172DWE

**\$89 COMPACT**



**3.6V CORDLESS TWIST XTRA® SCREWDRIVER**  
With battery and charger. #2207

**\$19<sup>99</sup>**

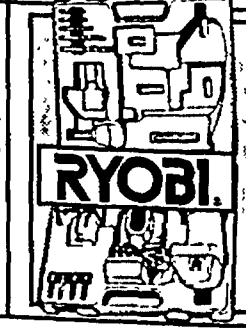

**7.2V CORDLESS VSR DRILL KIT** #CD75K  
(2) batteries.

**\$59<sup>95</sup>**



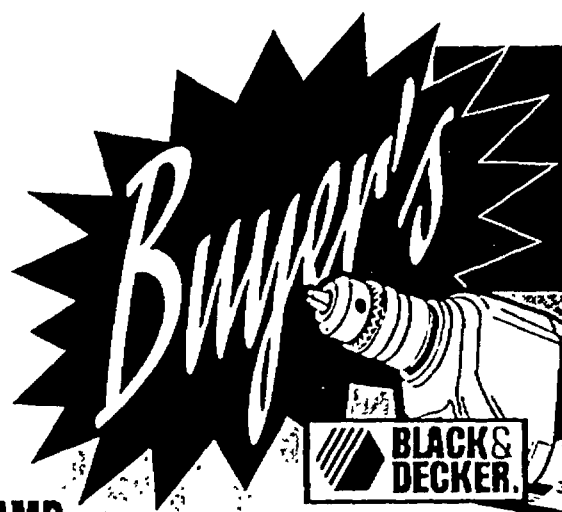

# HOLIDAY SPECIALS

**3 AMP 3/8" VSR DRILL**  
Variable speed trigger switch for a variety of applications.

**29<sup>97</sup>**

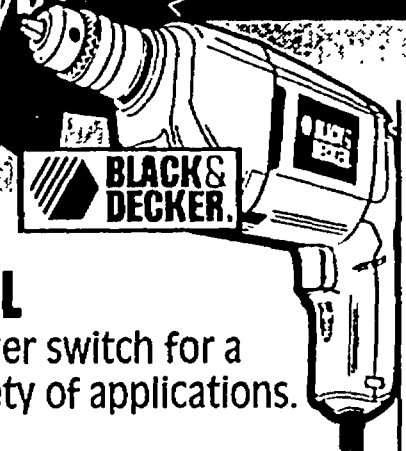

#7190

**3 AMP 3/8" DRILL**  
1/3 HP. Variable speed, reversing. Built-in chuck key storage.

**29<sup>94</sup>**

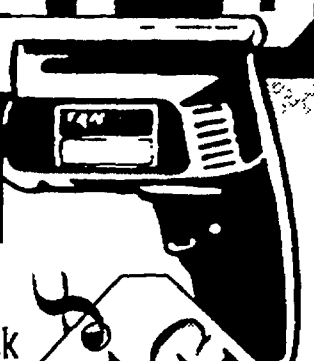

#6225

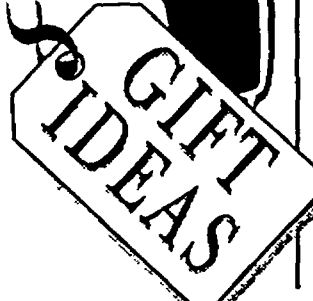

**RYOBI 3/8" CORDED CLUTCH DRILL**  
Keyless chuck. Six clutch positions. 10' power cord. Adjustable torque settings.

**\$39**

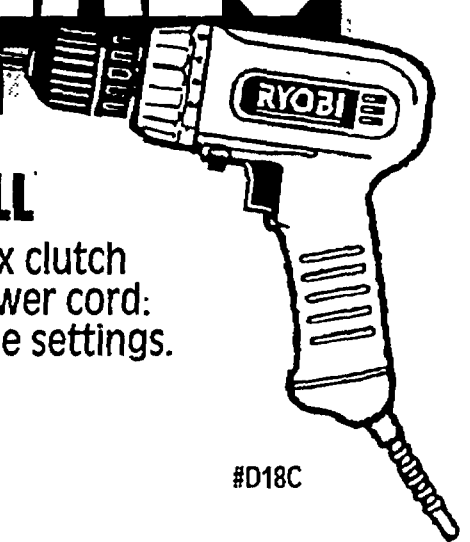

#D18C

**4 AMP 3/8" HEAVY-DUTY DRILL**  
Built-in 2-way level. 0-2500 rpm. #DW100

**60<sup>41</sup>**

Variable speed reversing

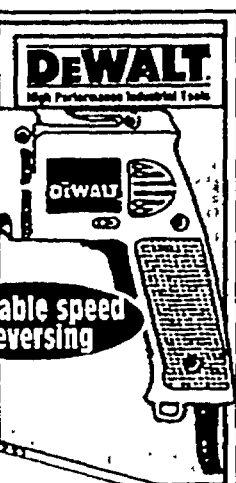

**300/1200 RPM HOLE-HAWG®**  
Powerful, yet compact for large hole drilling between joists/studs. Triple gear reduction. #1675-6

**\$279**

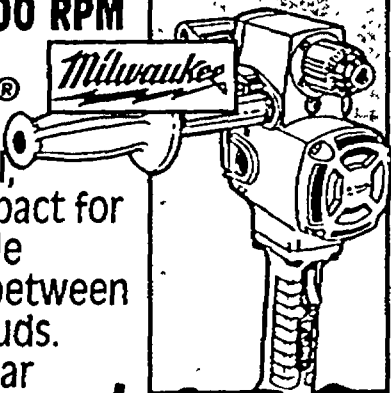

**3/8" KEYLESS CHUCK DRILL**  
4.0 amps, 0-2500 rpm, reversible. Keyless chuck for quick and easy bit changes. #BD1000

**\$54**

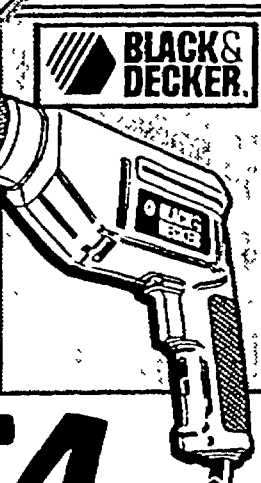

**1/2" XTRA TOOL®**  
3.4 amp. 4 tools in 1 drill, screwdriver, hammerdrill, power chisel. #600

**\$79**

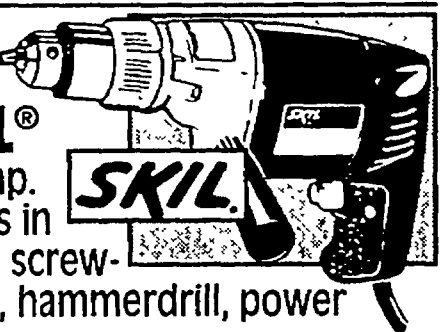

**1/2" HEAVY-DUTY HAMMER DRILL**  
Includes steel case. Variable speed, reversing. 360° side handle with depth rod.

**\$169**

#DW510K

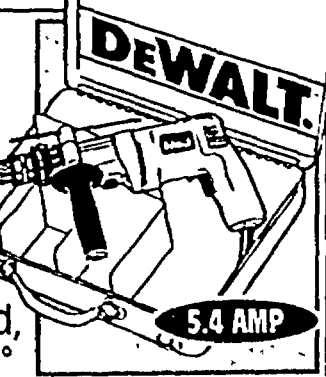

**5.2 AMP DRYWALL SCREW GUN**  
Large variable-speed trigger. Double insulated for operator safety. In-line pistol grip design for greater control. #6821

**\$89**

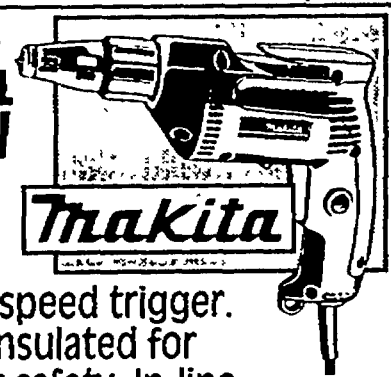

**1/2" VSR HAMMER DRILL**  
4.0 amps, 0-2500 rpm, reversible. Hammer action for drilling into masonry. #7277

**65<sup>95</sup>**

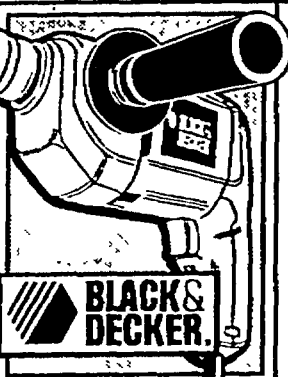

**3/8" VARIABLE SPEED REVERSIBLE DRILL**  
Ergonomic "Power Grip" handle. 10 ft. rubber cord. Jacobs® keyless chuck. #D28VSR

**\$39**

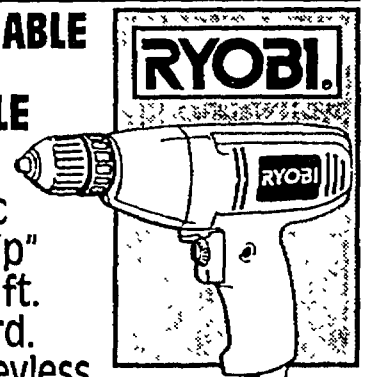

**Great deals on all the accessories anyone could want.**

**32-PIECE BUILT-A-SET™**  
Set can be customized with up to 4 pages to hold 80 access. #99332



**14<sup>99</sup>**

**15 PIECE COMBO DRILL BIT SET**  
Includes (6) woodboring bits, (5) Hanson® metal bits & (4) Hanson® drill bits. #601599D60

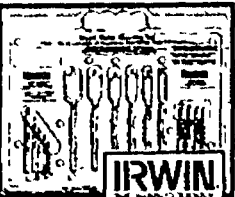

**14<sup>88</sup>**

**20 PIECE DRILL BIT SET**  
Roll forge process provides maximization of material strength. #15086

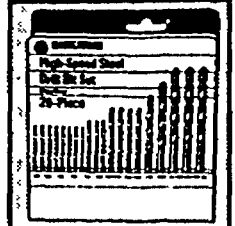

**\$26**

**DRILL SHARPENER**  
Includes video, grinding unit. #DRC419US

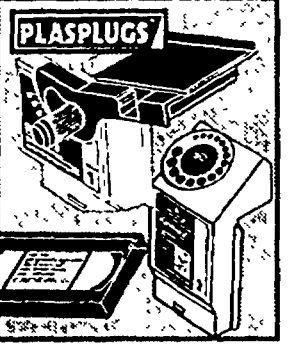

**49<sup>97</sup>**

**39-PIECE INSERT BIT NUTSETTER**  
#03340PP

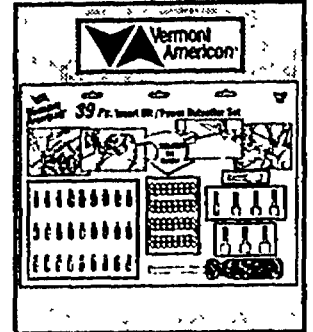

**19<sup>97</sup>**

**23-PIECE DRILL ACCESSORY PACK**  
#03341PP

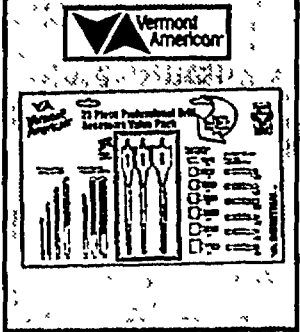

**14<sup>97</sup>**

**49-PIECE POWER TOOL ACCESSORY SUPER VALUE PACK**  
#03342PP



**24<sup>97</sup>**

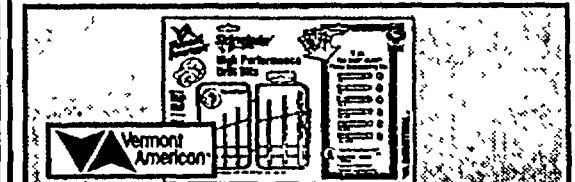

**SIDEWINDER DRILL SET**  
#03343PP

**9<sup>97</sup>**

**SUPER SAVINGS ON POWERFUL GIFTS!**

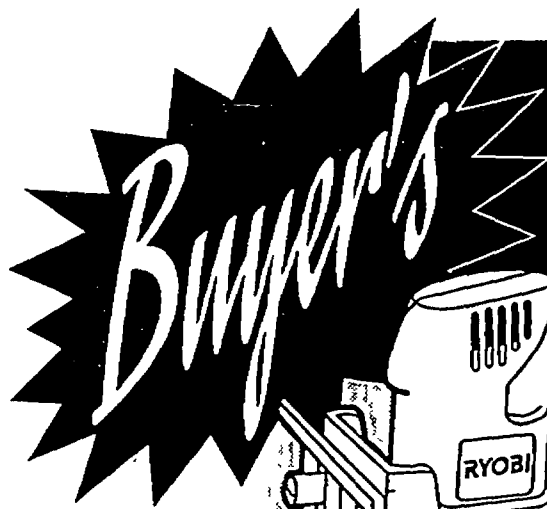

# HOLIDAY SPECIALS

## DETAIL BISCUIT JOINER

**RYOBI**

Reversible fence for 90° and 45°. Comfortable 2-position hand grip.

#DBJ50

**69<sup>97</sup>**

## DREMEL<sup>®</sup> VARIABLE SPEED MULTI PRO™ KIT

Includes Quick change, Collet Nut, 1/8" Collet, wrench, 72 access, 175 plus use book and storage case. #3955

**59<sup>98</sup>**

## VERSAPACK KIT BOX

Includes Versapak 7.2V two-speed cordless drill, multi-purpose saw, snakelight™, two versapak batteries, charger and kit box.

#VPDRMSSN

**99<sup>97</sup>**

#VPDRMSSN

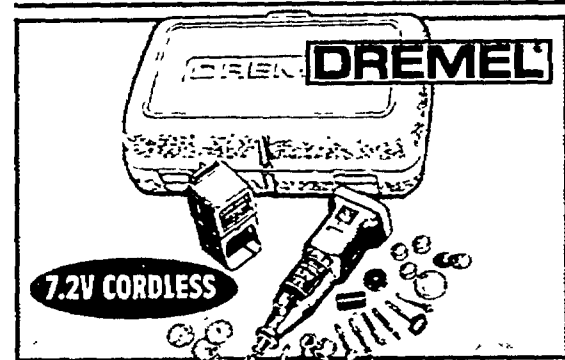

## MULTIPRO KIT

Includes 7.2V multipro tool w/battery, 110 3 hour rapid charger, custom carrying case, 25 general purpose accessories.

#7700

**\$47**

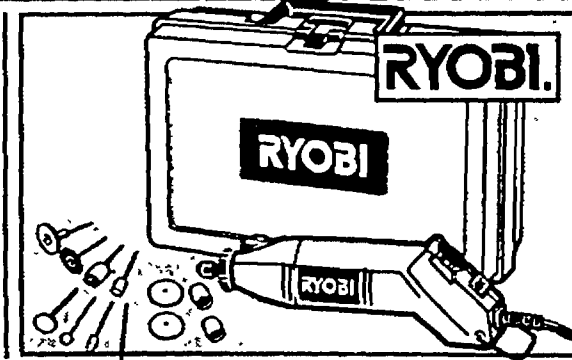

## 101-PIECE MULTI-TOOL KIT

99 Access bits and case. Variable speed.

**\$49**

#HT 20VSK

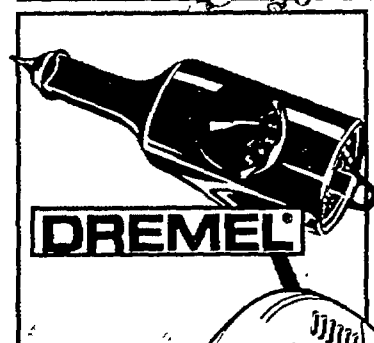

## ENGRAVER

Includes replaceable carbide steel engraving point.

**\$17**

#290

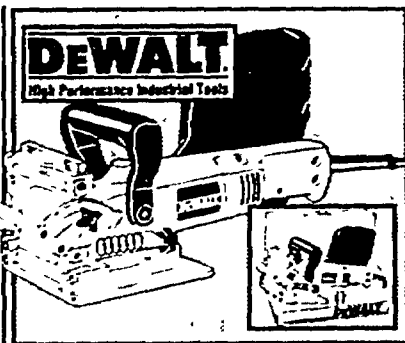

## HEAVY-DUTY PLATE JOINER KIT

Includes blade, dust collection system and steel case.

**\$225**

#DW682K



## DETAIL SANDER

Oscillating action for extra fine finishes.

**\$37**

#DS1000



## DETAIL SANDER

Batteries and charger sold separately.

#VP510T

**\$35**

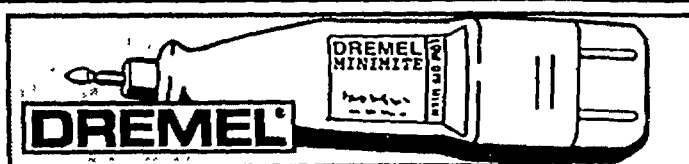

## MINIMITE™ CORDLESS ROTARY TOOL

Removable battery pack, 3 hour recharge.

#750

**\$29**

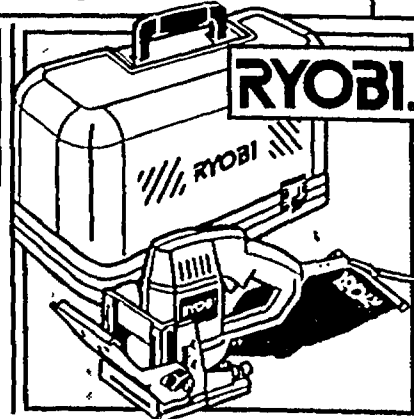

## BISCUIT JOINER KIT

Kit includes #0, #10 and #20 biscuits and carrying case.

**\$99**

#JM80K

**Defy high prices... shop here and save on stocking stuffers!**

## 12.0 VOLT CORDLESS FLASHLIGHT

90° Swivelling head. Battery and charger sold separately.

#DW904

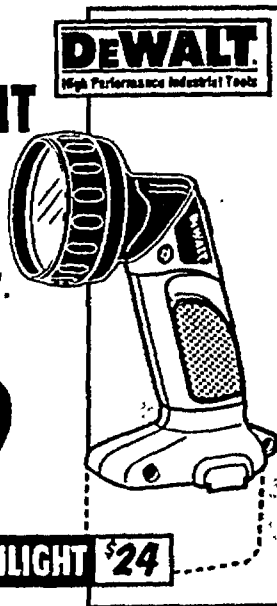

**\$29**

9.6V FLASHLIGHT \$24

## MOTO TOOL ROUTER ATTACHMENT

Moto-tool not included.

#230

**\$24**

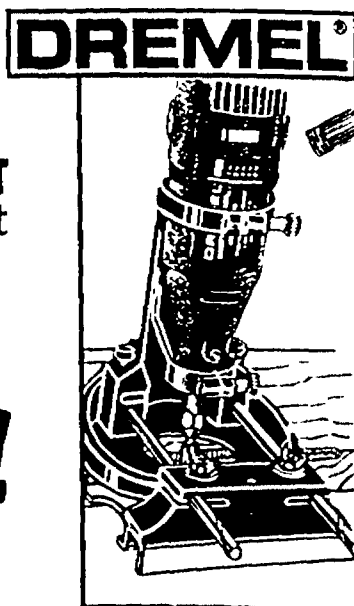

## MOTO TOOL FLEX-SHAFT ATTACHMENT

#225

**\$24**

## CUTTING/CARVING BIT SET

30 piece consisting of 2 reinforced cut-off wheels, 18 cut-off wheels, 1 mandrel, 3 high speed cutters, 1 engraving cutter, 1 grinding stone, 1 drum sander, 1 course sander band, 2 fine sander bands.

**\$9<sup>97</sup>**

# Buyer's Specials

Build gifts that become heirlooms.

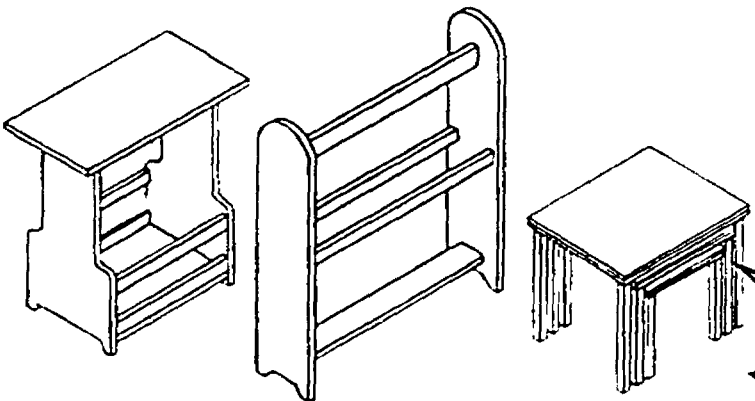

Quality woods for the serious home woodworker.

 Weyerhaeuser

## CHOICEWOOD HARDWOOD BOARDS

Species Available: OAK, MAPLE & POPLAR  
 Thickness Available: 1/4", 1/2" & 3/4"  
 Widths Available: 2", 3", 4", 6" & 8"  
 Length Available: 2', 3', 4', 6', & 8'  
 Availability of Width, Thickness, Length vary by species.

**10% OFF**

\*CHOICEWOOD HARDWOOD BOARDS

### ATTENTION CUSTOMERS:

TO CORRESPOND WITH THE LUMBER COMMODITY MARKET OUR PRICES ARE ADJUSTED DAILY. PRICES IN THIS AD MAY VARY FROM ACTUAL PRICES AT TIME OF PURCHASE.



**Nobody beats our prices on hobby wood.**

### PLYWOOD PANELS

Perfect for smaller jobs and craft projects.

SIZE	1/4"	1/2"	3/4"
2x4	\$4	\$5	6.50
4x4	\$8	\$10	\$13
4x8	12.49	\$16	\$21

### WHITWOOD BOARDS

Used for shelves, boxes, braces and 100's of other projects. Tight sound knots.

SIZE	6'	8'	10'	12'
1x4	1.93	2.50	3.19	3.98
1x6	2.96	3.64	4.68	5.98
1x8	3.69	4.79	6.98	8.68
1x10	5.54	6.56	9.96	11.28
1x12	6.48	8.98	11.98	14.98

### HARDWOOD PLYWOOD

Used for shelves, boxes, braces and 100's of other projects. Tight sound knots.

SIZE	1/4"	3/4"	1/4"	3/4"
GRADE	BIRCH	BIRCH	OAK	OAK
4x8	19.95	42.95	25.95	47.95

### 8" PINE SHELF BRACKET

100% solid wood. Elegant enough for display, sturdy enough for storage. Easy to install. Includes all necessary parts & hardware.

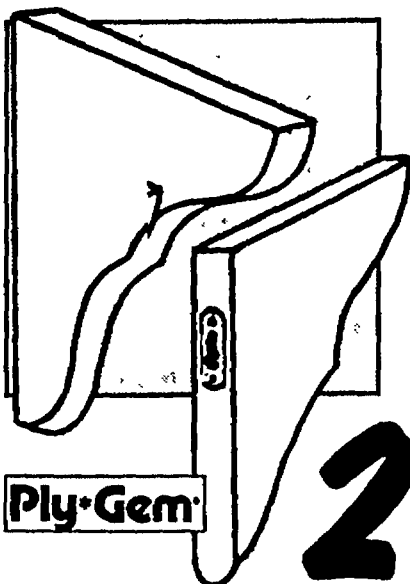

Ply-Gem

**265**

10" SHELF BRACKETS 3.20

12" SHELF BRACKETS 3.95

### 18x36 ASPEN EDGE GLUE BOARDS

All full length. Edge-glued Aspen help minimize cupping warping. Pre-sanded.

**12<sup>88</sup>**

18x48 ASPEN BOARD 17.88

18x72 ASPEN BOARDS 25.88

### Ask us about Special ORDER

We can special order a dazzling array of BUILDING MATERIAL PRODUCTS from a variety of manufacturers. Our special order catalogs contain many styles in price ranges to fit any budget.

**24 HOUR DELIVERY!**



(Purchases over \$300 delivered in a 10 mile radius of the store.)

**SUPER SAVINGS ON POWERFUL GIFTS!**

**GIVE MORE POWER FOR LESS MONEY!**



# HOLIDAY SPECIALS

**RYOBI**

**10" WOODCUTTER SYSTEM WITH OPTIONAL ACCESSORIES**

**\$1079**

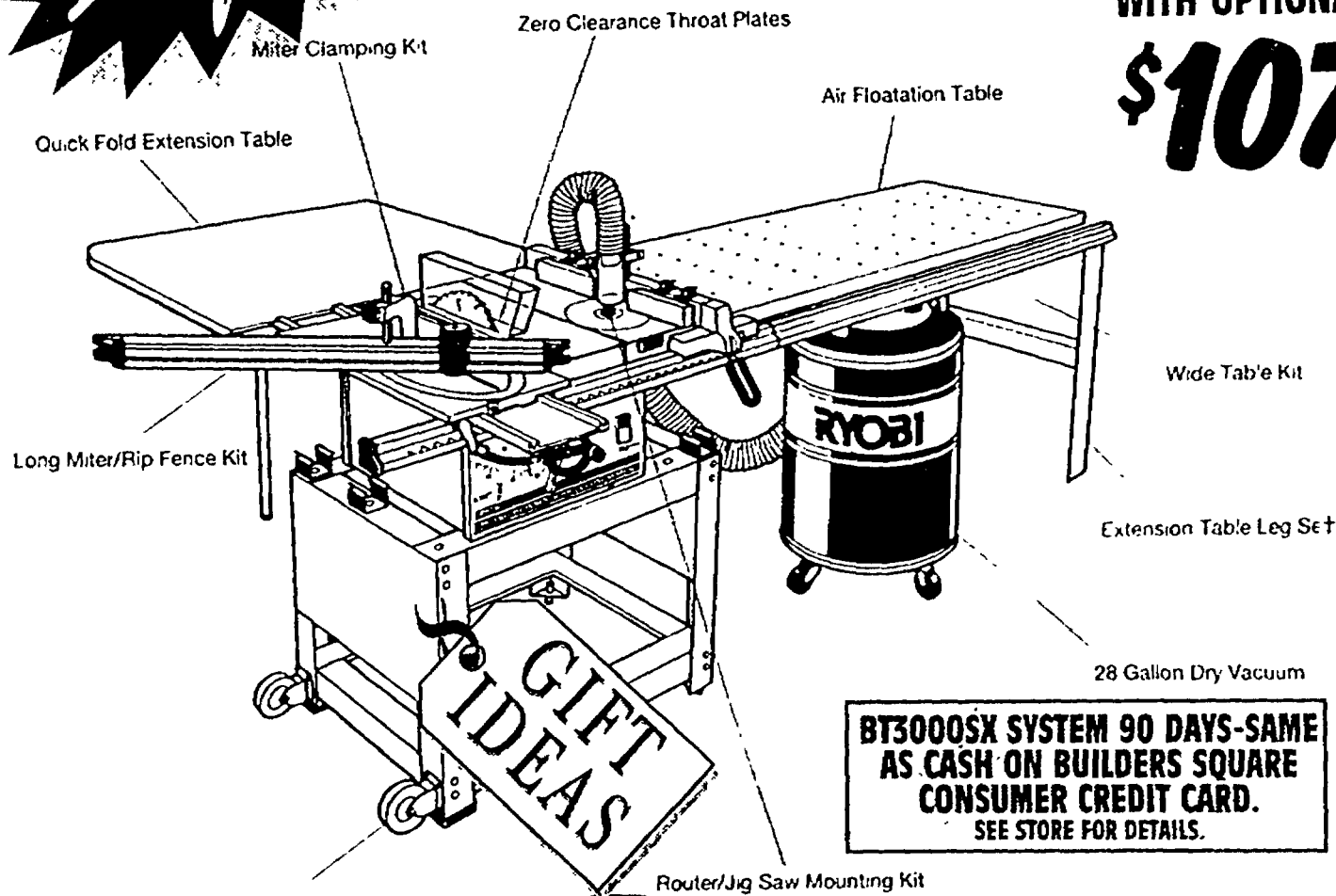

**GIFT IDEAS**

**BT3000SX SYSTEM 90 DAYS-SAME AS CASH ON BUILDERS SQUARE CONSUMER CREDIT CARD. SEE STORE FOR DETAILS.**

<b>BT3000SX SAW AND STAND</b>	<b>\$487</b>
<b>QUICK FOLD EXTENSION TABLE</b>	<b>'77</b>
<b>ROUTER MOUNT KIT</b>	<b>'69</b>
<b>WIDE TABLE KIT</b>	<b>'99</b>
<b>28 GAL. DRY VACUUM</b>	<b>'112</b>
<b>AIR FLOTATION TABLE</b>	<b>'84</b>
<b>CASTERS</b>	<b>'17</b>
<b>EXTENSION LEG SET</b>	<b>'29</b>
<b>LONG MITER/RIP FENCE</b>	<b>'59</b>
<b>MITER CLAMPING KIT</b>	<b>'29</b>
<b>THROAT PLT. ZERO CLEARANCE</b>	<b>'17</b>

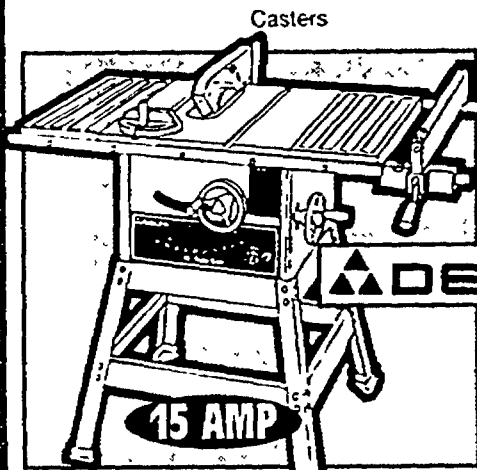

**10" TABLE SAW**  
Two year limited warranty. Heavy steel stand.

**\$354**

#34-670

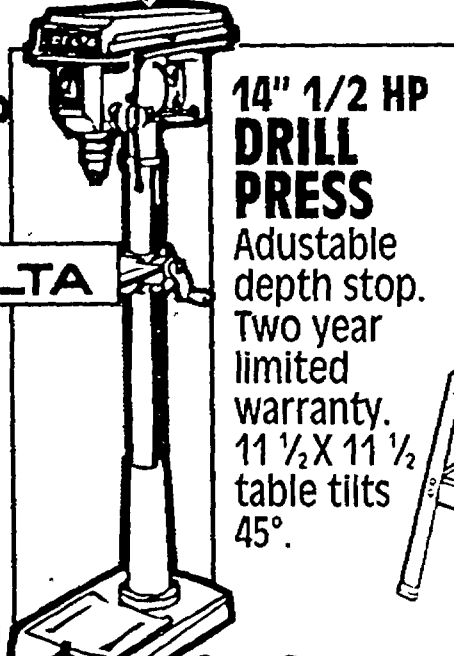

**14" 1/2 HP DRILL PRESS**  
Adjustable depth stop. Two year limited warranty. 11 1/2 X 11 1/2 table tilts 45°.

**\$299**

#14-070

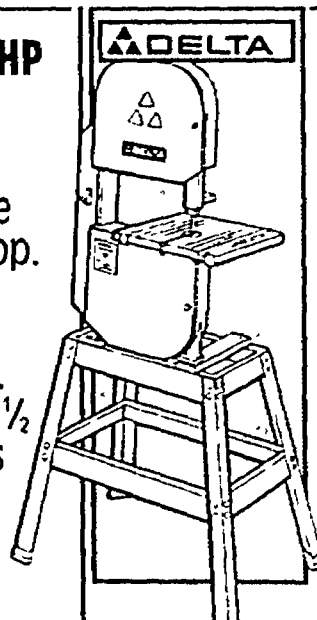

**12" BAND SAW**  
1/2 H.P., 115V motor. 2 year limited warranty. Cuts up to 6" thick. Large die-cast aluminum tilting table.

**\$377**

#28-190

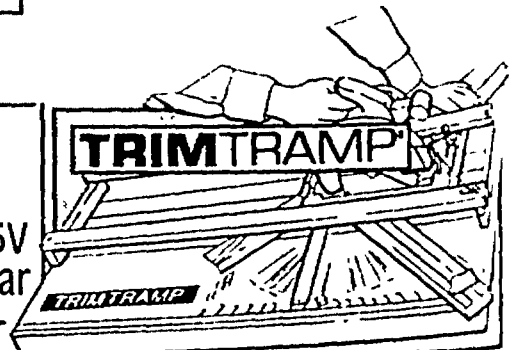

**PROFESSIONAL MITER SAW TABLE**  
Perfect 90° miter joints, crosscuts 19" wide, bevels, compound miters, variable angles, dado and rabbet cuts.

**249<sup>99</sup>**

#300

**ROUTER KIT ADAPTER 39.99**

**Great deals that'll delight any do-it-yourselfer.**

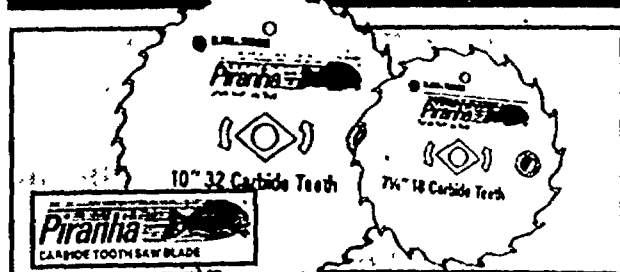

**10" 32 TOOTH CARBIDE PIRANHA SAW BLADE**  
Includes a free 7 1/4" 18T blade. #73740PP

**19<sup>99</sup>**

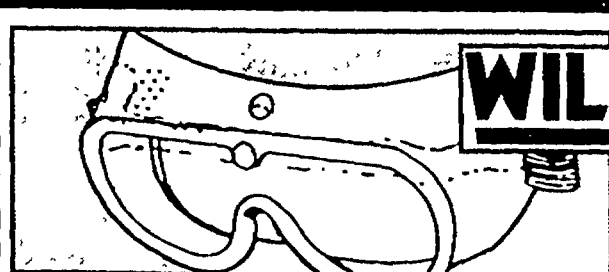

**SAFETY GOGGLE**  
Soft, lightweight clear vinyl frame fits comfortably over most eyewear. #CPV-404

**2<sup>76</sup>**

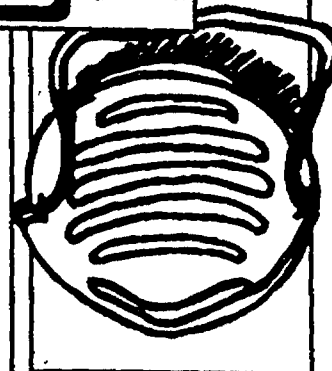

**5 PACK DUST MASK**  
Lightweight, disposable.

**2<sup>99</sup>**

#CP-1000C

#2411

**Bumper's**

# HOLIDAY SPECIALS

## PRO-TECH

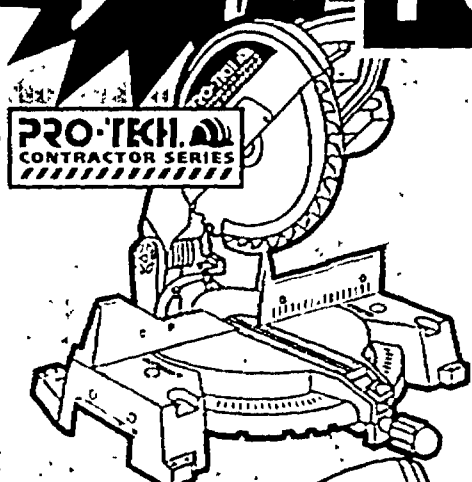

**12" COMPOUND MITER SAW**  
Powerful 15 amp motor, 4000 rpm. #CS7212

**299<sup>99</sup>**

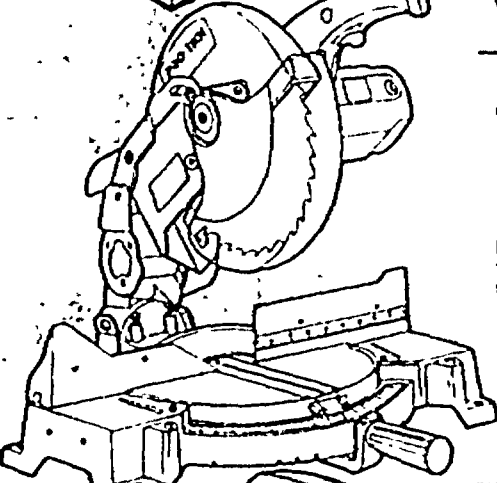

**10" COMPOUND MITER SAW**  
Powerful 15 amp motor, 5000 rpm. Full 1 year warranty. #7208

**199<sup>96</sup>**

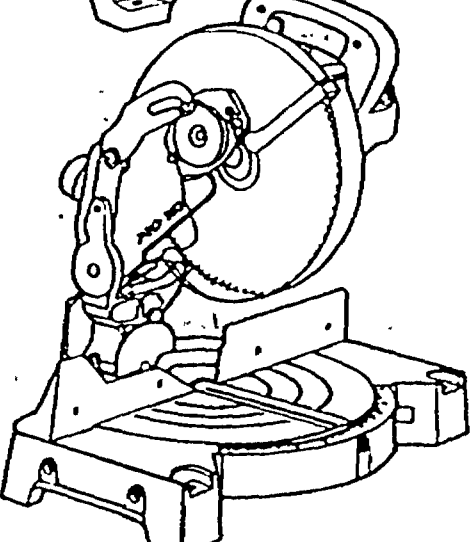

**8-1/4" COMPOUND MITER SAW**  
9 amp motor, 5200 rpm. Full 1 year warranty. #7203

**119<sup>96</sup>**

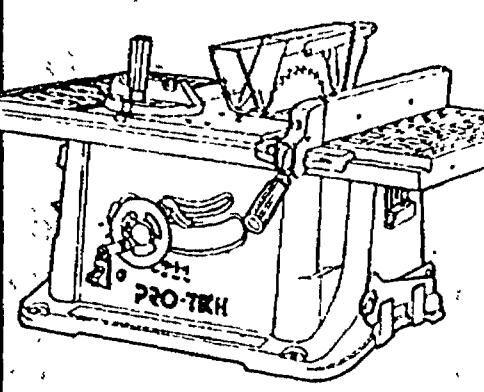

**10" TABLE SAW**  
13 amp motor, 4800 rpm. Full 1 year warranty. Double insulated. #4106

**129<sup>96</sup>**

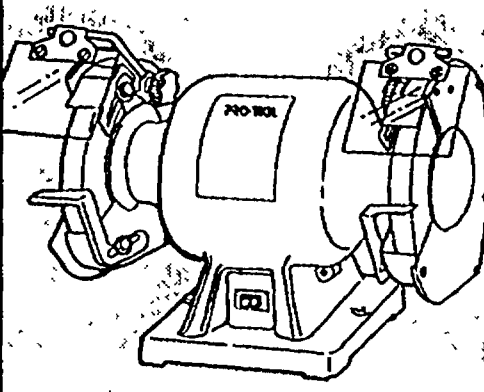

**6" BENCH GRINDER**  
3.5 amp induction motor, 3500 rpm 1/3 hp. Full 1 year warranty. #8102

**37<sup>96</sup>**

## DELTA

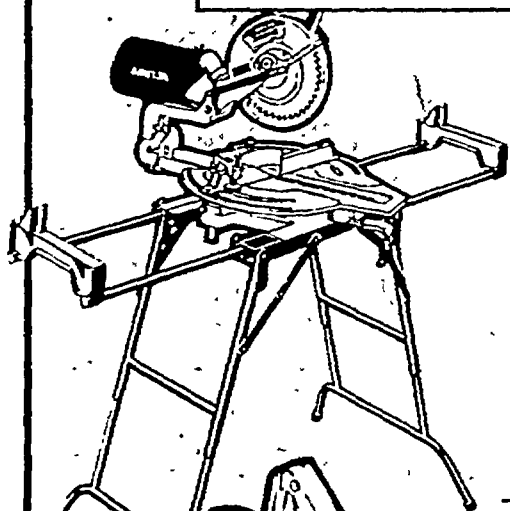

**SIDEKICK® 10" SLIDING COMPOUND MITER SAW**  
One-piece die cast aluminum table with dual rod, linear ball-bearing guide system.

**\$498** #36-250

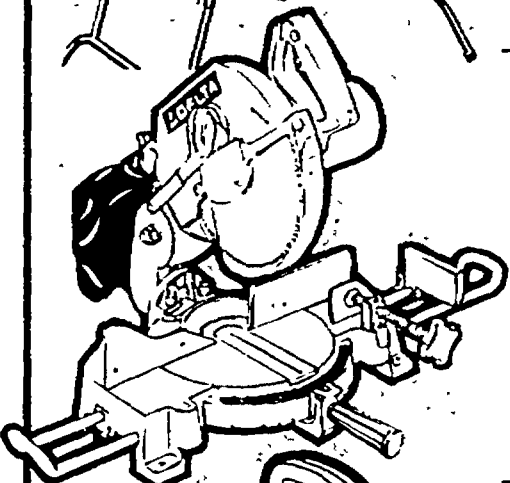

**10" COMPOUND MITER SAW**  
Two year warranty. Includes work supports, clamp and dust bag.

**\$199** #36-220

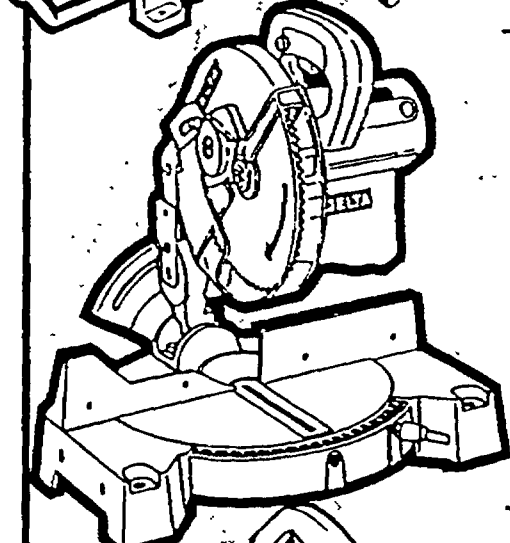

**8 1/4" COMPOUND MITER SAW**  
9.0 amp, 5,200 rpm. Lightweight for job site portability. Two year limited warranty.

**\$139** #36-040

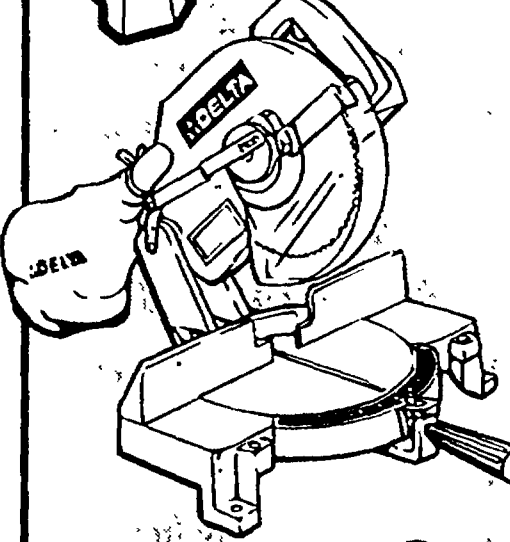

**10" POWER MITER SAW**  
13 amp/5,200 rpm motor. easily carried-weighs only 28 lbs. Cuts 2x4 or 4x4 at 90° and miter a 2x4 at 45°.

**\$149** #36-070

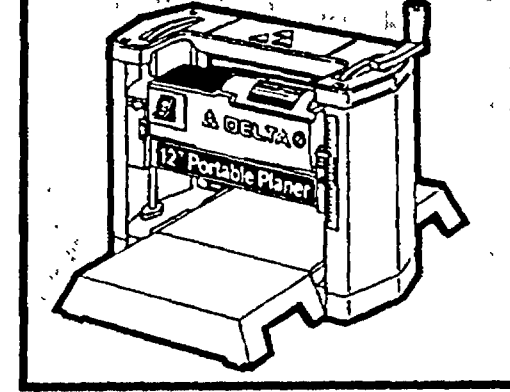

**12-INCH PORTABLE PLANER**  
15.0 amp, 8,000 rpm. 12"x26" table with extensions. Two year limited warranty.

**\$359** #22-540

**BIG VALUES FOR HOLIDAY GIVING!**

**SUPER SAVINGS ON POWERFUL GIFTS!**

**GREAT BUYS ON A GREAT SELECTION.**

**Bumper's HOLIDAY SPECIALS**

**18 VOLT EXTREME CORDLESS**  
GET WITH THE SYSTEM

**18.0V CORDLESS 5-3/8" BLADE SAW KIT**  
#DW936K

**\$247**



**Milwaukee**

**HEAVY DUTY SAWZALL® PLUS** WITH QUICK-LOK BLADE CLAMP

Trigger speed control  
0- 2,800 SPM. #6517-20

**\$149**

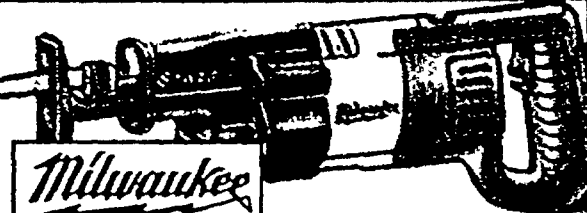

**SKIL**

**VARIABLE SPEED JIGSAW**  
Includes: one woodcutting blade, blade/foot wrench. 3 AMP.  
#4235

**29<sup>98</sup>**



**BLACK & DECKER**

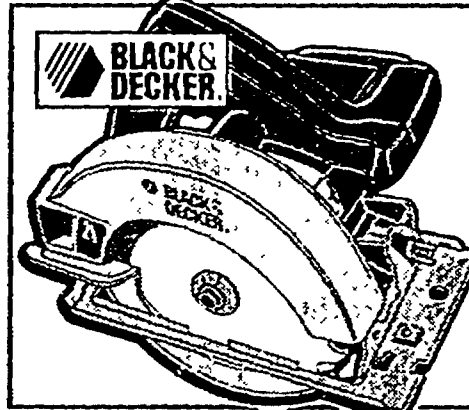

**7-1/4" CIRCULAR SAW**  
10 AMP, 2.3 HP motor.  
Compact balanced design. #7359

**\$39**

**SKILSAW**

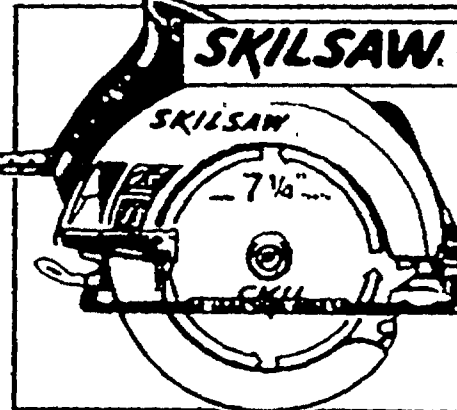

**7-1/4" CIRCULAR SAW**  
2-1/3" HP, 10 AMP,  
4,600 RPM. Cuts 2-7/16" at 90°. #5150

**39<sup>97</sup>**

**DEWALT**  
High Performance Industrial Tools

**14.4V 5-3/8" CORDLESS SAW WITH CASE**  
3000 RPM for fast cutting.  
#DW935K

**\$239**



**DEWALT**  
High Performance Industrial Tools

**LIGHTWEIGHT 7-1/4" SAW WITH CASE**  
Powerful 13.0 AMP AC/DC motor. #DW359K

**124<sup>99</sup>**

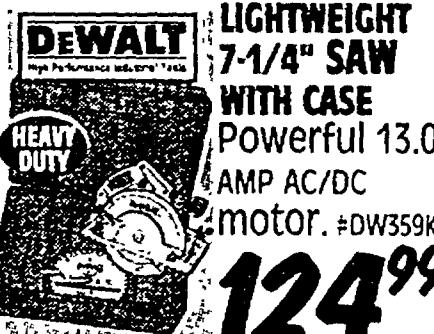

**BOSCH**

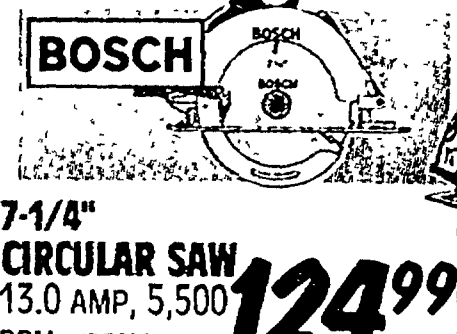

**7-1/4" CIRCULAR SAW**  
13.0 AMP, 5,800 RPM.  
2-3/8" cut at 90°. #6365

**145<sup>98</sup>**

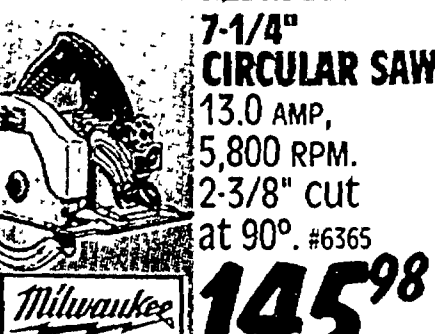

**Makita**  
IS ALLEN WORTH IT

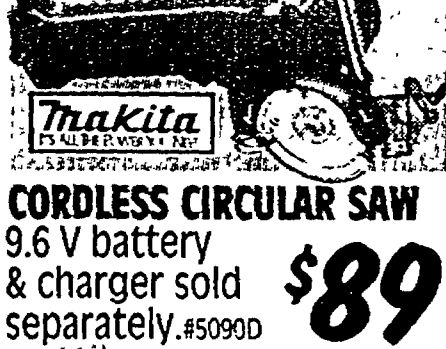

**Makita**  
IS ALLEN WORTH IT



**SKILSAW**



**Makita**  
IS ALLEN WORTH IT



**Makita**  
IS ALLEN WORTH IT



**BLACK & DECKER**



**BLACK & DECKER**



**Makita**  
IS ALLEN WORTH IT



**BLACK & DECKER**



**BLACK & DECKER**

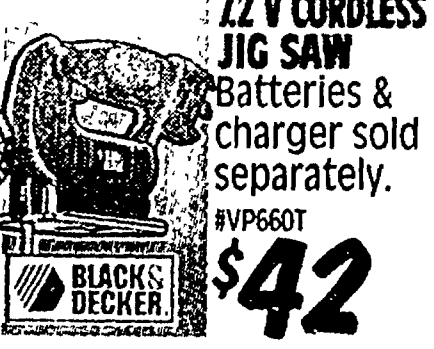

**Milwaukee**



**RYOBI**  
VARIABLE SPEED



*Bumper's*

# HOLIDAY SPECIALS

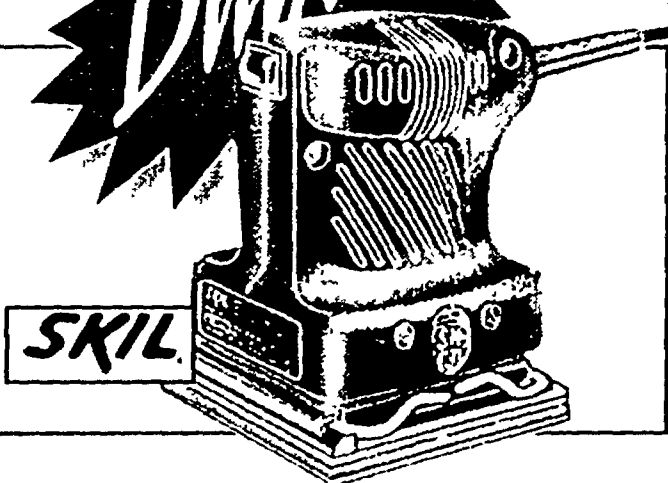

**PALM GRIP SANDER**

NOW ONLY

**29<sup>99</sup>**

WAS 37.66

1.7 AMP.  
1/4 sheet size  
sanding paper.  
Flush sanding  
on 3 sides.

#7275

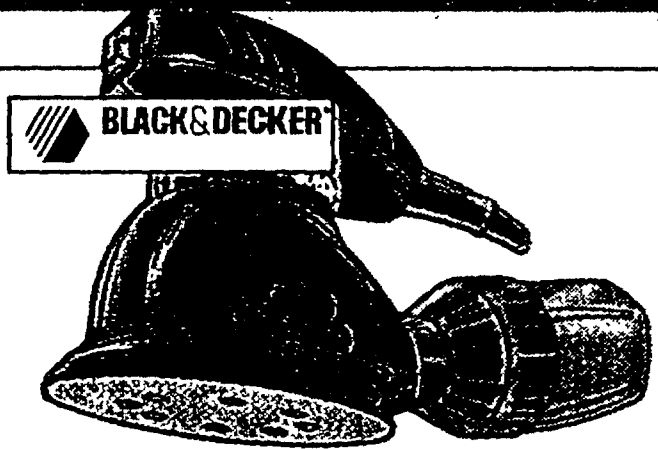

**PALM GRIP RANDOM ORBIT SANDER**

**39<sup>94</sup>**

2 AMP. Random orbit action for super smooth finish & fast material removal. #R0100

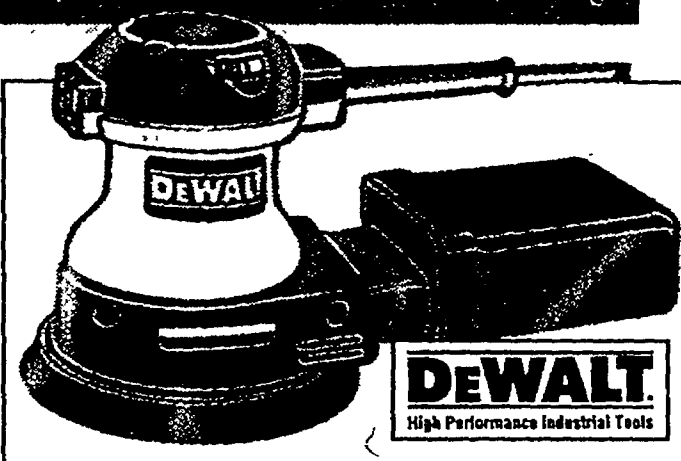

**5" HEAVY DUTY RANDOM ORBIT PALM SANDER**

**89<sup>88</sup>**

2.0 AMPS,  
12,000 OPM.  
Electronic variable speed. #DW423

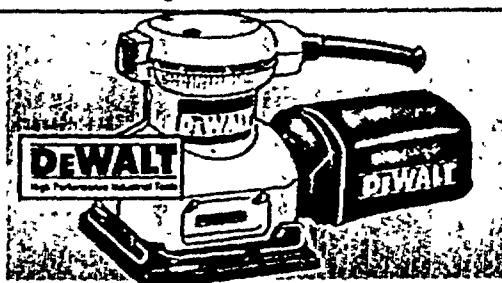

**1/4 SHEET HEAVY DUTY PALM GRIP SANDER**

1.7 AMP, 13,500 OPM. 100% sealed ball-bearing construction. #DW411

**\$49**



**Makita**

**RANDOM-ORBIT SANDER**

Palm-size sander with 10,000 OPM. 5/32" orbit diameter. Low noise level with reduced vibration. #B05001

**59<sup>94</sup>**



**RANDOM ORBIT PALM SANDER**

Free floating pad with random rotation creates swirl free finish. #6019-6

**\$69**

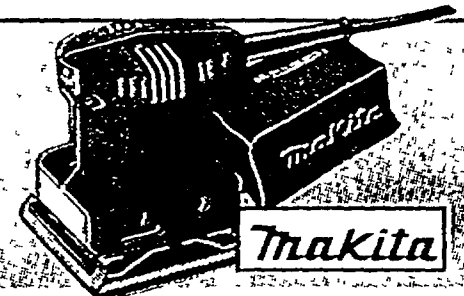

**FINISHING SANDER WITH DUST BAG**

1.6 AMP, 14,000 OPM. Uses 1/4 sheet sandpaper. Compact and lightweight. #B04552

**\$46**

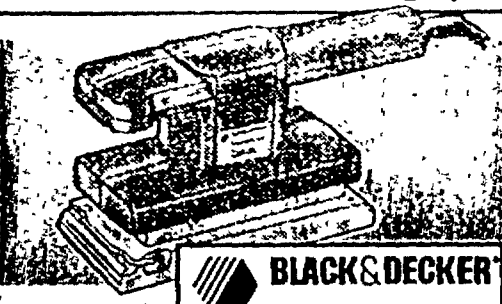

**1/3 SHEET ORBITAL FINISHING SANDER**

1.6 AMP, speed orbital action. Level activated paper clamps for easy changes. #7448

**29<sup>16</sup>**



**1/3 SHEET FINISHING SANDER WITH DUST EXTRACTION**

Front handle for extra control. Easy mount paper clamps. Dust sealed switch. #FS350

**44<sup>99</sup>**



**3"x21" VARIABLE SPEED BELT SANDER**

WITH DUST COLLECTION  
5.2 AMPS. Belt tracking knob for quick alignment. #B0550

**\$99**

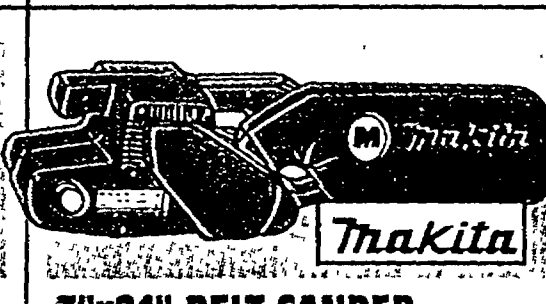

**3"x21" BELT SANDER WITH DUST BAG**

6.7 AMP, 1,246 FPM. Lightweight, only 7.7 lbs. Sands flush to wall. #9901

**157<sup>17</sup>**

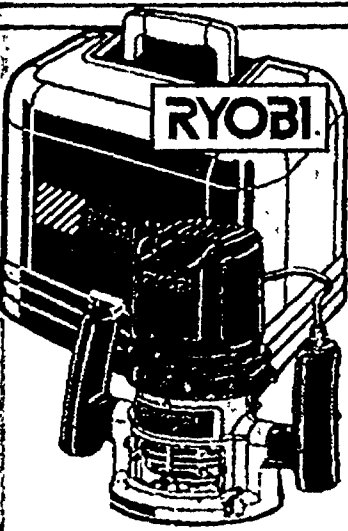

**1-1/2 HP ROUTER KIT**

8.0 AMP ball-bearing motor. 25,000 RPM. Die cast aluminum base. Carrying case included. #R160K

**\$59**

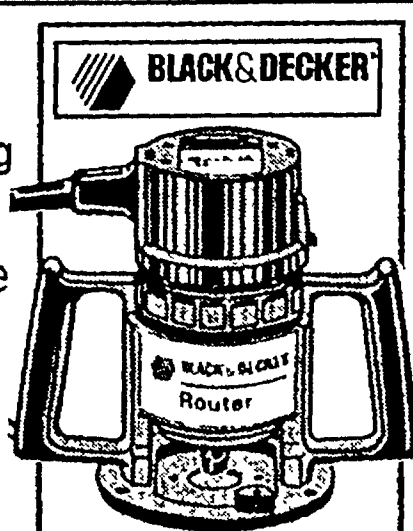

**BLACK & DECKER**

**1 HP ROUTER**

5.0 AMP, 30,000 RPM. All ball-bearing construction. Ring type depth adjustment calibrated in 1/64" increments. #7604

**\$49**

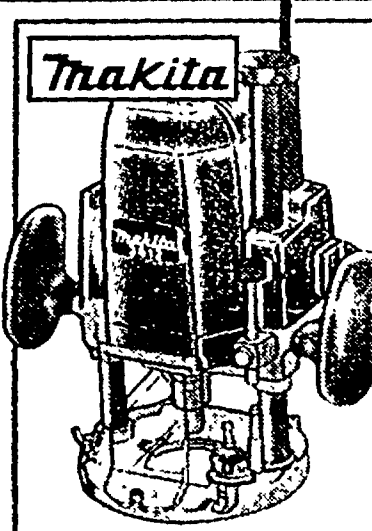

**Makita**

**3 HP ROUTER**

Powerful 15 AMP Motor delivers 22,000 RPM for smooth routing. Multiple depth capacity. #3612

**\$199**

**SUPER SAVINGS ON POWERFUL GIFTS!**

**SPECIAL SAVINGS ON GREAT GIFT IDEAS!**

*Buyer's*

# HOLIDAY SPECIALS



**1 HP/1 GALLON WET/DRY VAC**  
 Vacuums wet or dry... indoors or out. Automatic shut-off when full. #505-50

**26<sup>96</sup>**



**5 GALLON SHOP VAC**  
 1.25 Tough by-pass motor, dent & rust resistant plastic tank. Vacs wet or dry, indoors or out. #505-10-7

**32<sup>57</sup>**

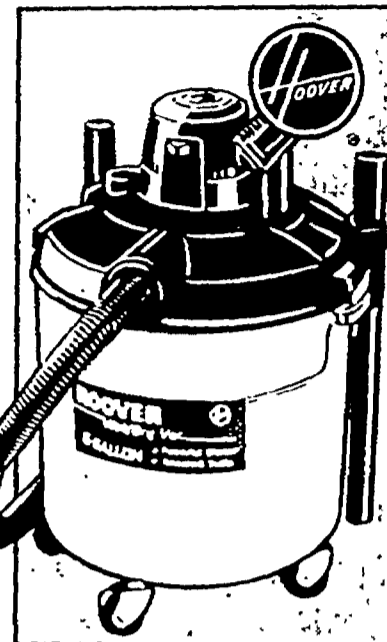

**6 GALLON WET/DRY VAC**  
 2 Year warranty. On board tools. Powerful blower. "No rust tank." #S6529

**\$37**



**2.25 HP/8 GALLON WET/DRY VAC**  
 Super quiet housing with powerful by-pass motor. #925-53

**\$59**



**3 HP/12 GALLON WET/DRY VAC**  
 Super quiet housing with powerful by-pass motor. #925-59-4

**69<sup>99</sup>**

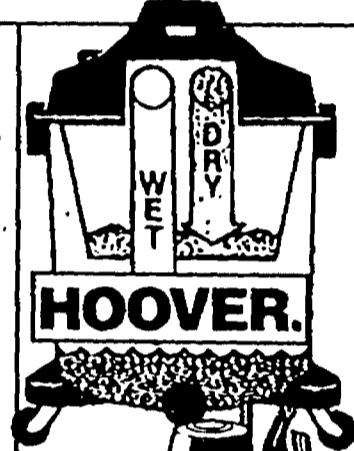

**12.5 GALLON WET/DRY VAC**  
 Patented 2 tank system. Instant wet to dry cleaning. #S6631

**89<sup>97</sup>**



**6 FOOT WORKBENCH KIT**  
 Sturdy 2'x6' construction. #WB 72

**44<sup>97</sup>**

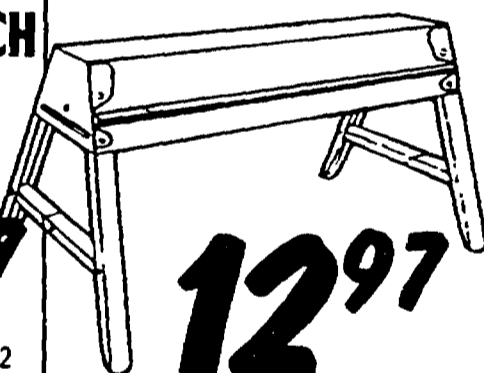

**STORAWAY SAWHORSE**  
 All steel construction. Collapses for transportation or storage. 31"Lx29-3/4Wx29"H. #SS-29

**12<sup>97</sup>**



**16 GALLON WET/DRY VACUUM**  
 Exclusive 2-tank system. #S6755

**129<sup>97</sup>**

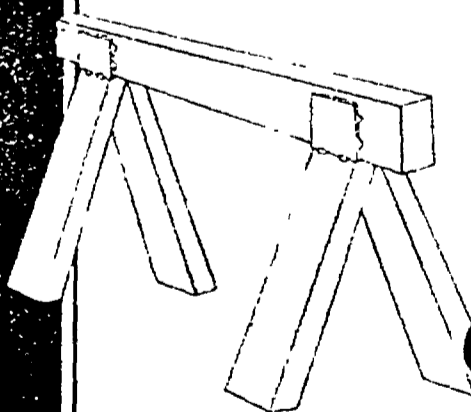

**SAWHORSE KIT**  
 Includes precut lumber & brackets. #SH29

**8<sup>99</sup>**



**WORKMATE 225 PROJECT CENTER**  
 Holds up to 450 lbs. #WM225

**59<sup>96</sup>**

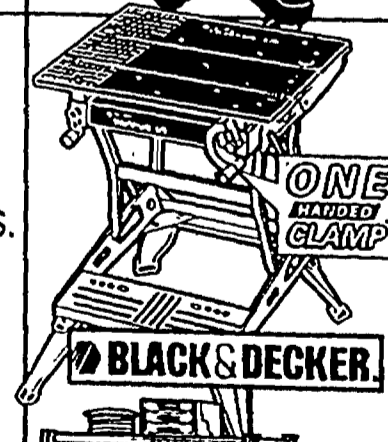

**WORKMATE 425 PROJECT CENTER**  
 Holds up to 550 lbs. #WM425

**99<sup>99</sup>**

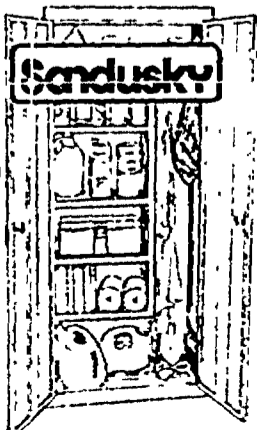

**STORAGE ORGANIZER**  
 Locking handles, 2 hanging hooks, 4 shelves & large area for tall items such as brooms & rakes. #7965PUTTY

**129<sup>95</sup>**  
 35x18x66 #7971-3  
**144.95**

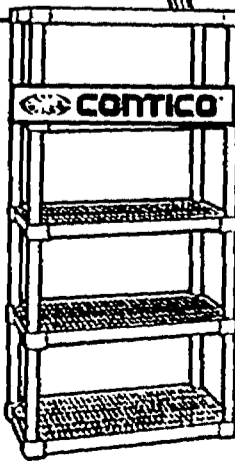

**VENTILATED STORAGE SHELF**  
 36"Lx72Hx18"W. Very strong, yet lightweight, 5 shelf. #3618-5BK

**\$44**

**INDUSTRIAL #4418-5GY \$69**  
**POTTING BENCH #V181-2GN 39.99**



**HEAVY DUTY STEEL SHELVING**  
 Black baked enamel; sturdy, steel construction. Extra rigid. #TLS86

**21<sup>99</sup>**

**4 SHELF #TBS466S 39.99**  
**MEGA RACK #TMR548 \$69**



**Buyer's**

# HOLIDAY SPECIALS

**GET IDEAS AND USES FROM THE SQUARE!**



**CleanMachine**  
1200 PSI  
**POWER WASHER**  
35' cord, 20' hose. #PW0731210

**\$147**

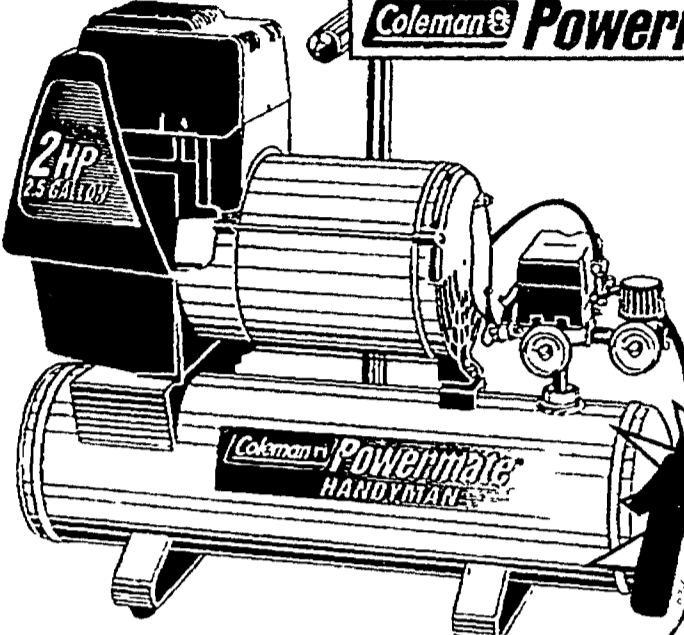

**Coleman Powermate**  
2 HP/2.5 GAL.  
**AIR COMPRESSOR**  
With bonus 9 pc. starter kit. #VC20C025PID101

**\$199<sup>96</sup>**

**Any item under \$400 as low as \$10\* per month**

**BUILDERS SQUARE**  
123456 78  
1111  
PREFERRED CUSTOMER  
\*With approved credit. Credit details on back page.



**CleanMachine**  
1300 PSI  
**ELECTRIC POWER WASHER**  
1300 P.S.I. pump pressure. Unique high pressure injection. #PW0751310.01

**\$188**

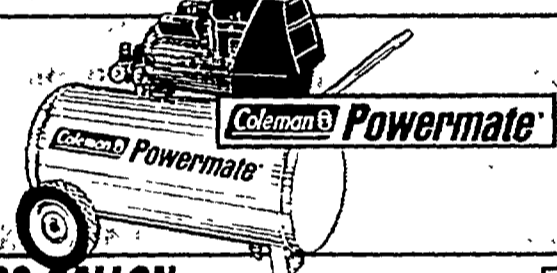

**Coleman Powermate**  
4 HP/20 GALLON  
**AIR COMPRESSOR**  
Maintenance free, oilless design. Operates on standard 115 volt current. #C40C200P1D101

**\$259**

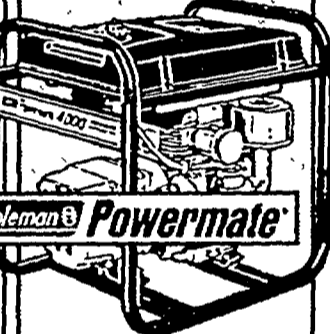

**Coleman Powermate**  
8 HP/4000 WATT  
**GENERATOR**  
4000 rated, 5000 surge watts of power. Dependable 8 hp, 4 cycle Briggs & Stratton engine. #PM0544202

**\$498**

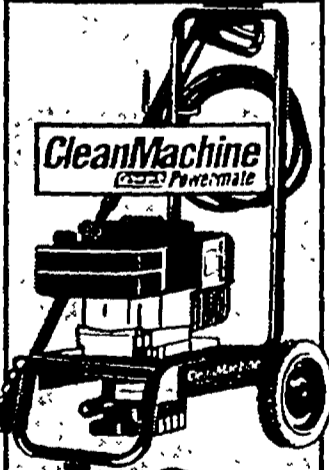

**CleanMachine**  
1500  
**POWER WASHER**  
3.5 H.P. Tecumseh engine. 25' hose, and a 1 year limited warranty. #PW0811505.01

**299<sup>99</sup>**



**Coleman Powermate**  
6.5 HP/25 GALLON PROFESSIONAL  
**AIR COMPRESSOR**  
Aluminum twin cylinder pump with precision bored cast iron sleeves. #C65C250P1B100

**\$367**

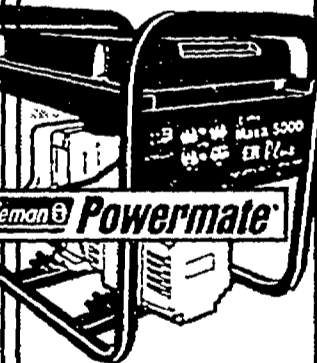

**Coleman Powermate**  
MAXA 5000 ER PLUS  
**GENERATOR**  
5000 rated, 6250 surge watts of power. Dependable 10 hp, 4 cycle engine. Large 5-gallon gas tank. #PM 0525302

**\$588**

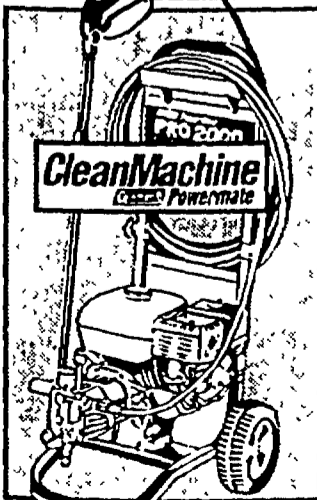

**CleanMachine**  
2000 PSI  
**POWER WASHER**  
5 HP, durable rubber tires. Collapsible handle for easy storage. 30 ft. reinforced pressure hose. #PW0832000

**449<sup>99</sup>**

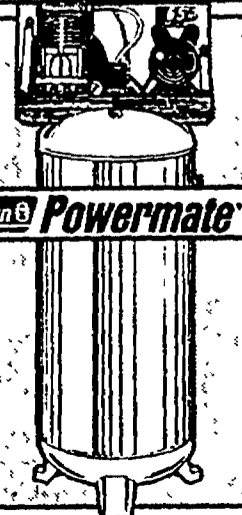

**Coleman Powermate**  
6.5 HP 60 GALLON PROFESSIONAL  
**AIR COMPRESSOR**  
Single stage twin cylinder pump with precision bored cast iron sleeves. Splash type lubrication. #C65C600V1B103

**\$398**



**Coleman Powermate**  
9 HP VANTAGE  
**GENERATOR**  
5000 watts, 6250 surge vantage generator. Briggs & Stratton Vanguard OHV engine. Cast iron cylinder sleeve. #PM0475003

**\$897**

**SPECIAL SAVINGS ON GREAT GIFT IDEAS!**



**10% OFF**  
**ALL KITCHEN & BATH FAUCETS**  
 IN STOCK ONLY, WHILE QUANTITIES LAST.

**GIFT IDEAS**

**BUILDERS SQUARE**  
**INSTALLS FAUCETS**  
**\$59** LABOR ONLY. JOB CODE #0510.  
 NORMAL REPLACEMENT INSTALLATION  
 #TACLA001191C, #62623, #PC81017705, #105954, #2102085035, #TACLB002928C, #210208503, #TACLA000876, #MN0006039, #0003812M4, ICT#1481, 3208, 2888, 2728, #41925

**MOEN**  
 Buy it for looks. Buy it for life.

**JAMECO**  
 INDUSTRIES INC.

THE BOLD LOOK OF **KOHLER**.

**STERLING**

**DELTA**  
 DELTA FAUCET COMPANY

**PEERLESS FAUCET**

**PRICE PFISTER**  
 THE PEERLESS FAUCET WITH THE PEERLESS NAME

*American Standard*

Ask us about **Special ORDER**  
 We can special order unique and wonderfully versatile selections from a variety of manufacturers.

**See us for useful gifts at unusually low prices.**

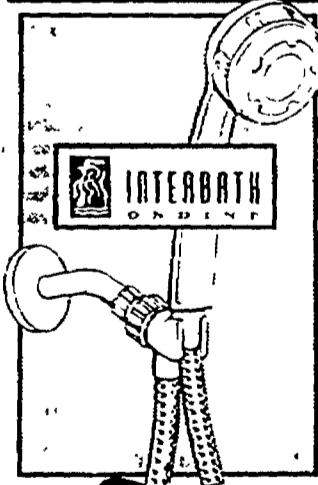

**INTOUCH MASSAGE SHOWER SET**  
 Self-cleaning spray ring reduces clogging.

**19<sup>96</sup>** WHITE #B1913AWW

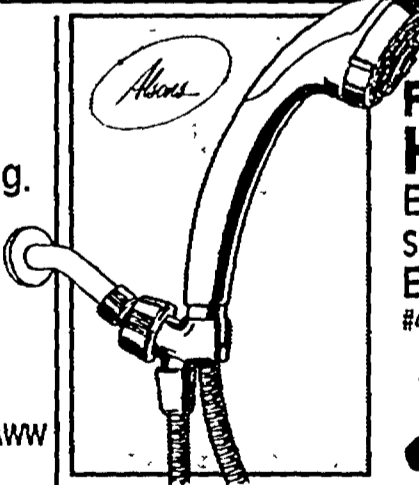

**FIVE SPRAY MASSAGE HAND SHOWER**  
 European design massage hand shower. Easy to install.  
 #4435RC WHITE

**24<sup>91</sup>**

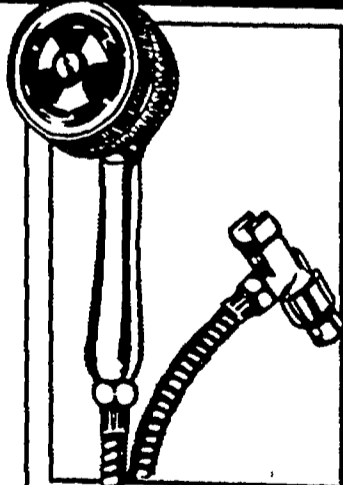

**HAND HELD SHOWER MASSAGER**  
 Use for pulsating, regular or combination spray. 60" flexible brass/mylar hose. #76-3501

**9<sup>99</sup>** CHROME WALL MOUNTED #76-350 4.99



**THE ORIGINAL SHOWER MASSAGE SHOWERHEAD**  
**8 SHOWER SETTINGS**  
 Certified energy & water saver, never uses more than 2.5 gallons/minutes.

**39<sup>97</sup>** CHROME #SM-82CCL

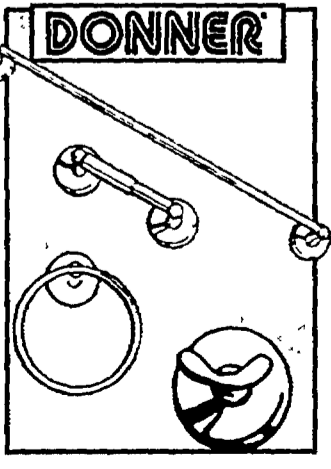

**DONNER YORKSHIRE 4-PC. BATH SET**  
 Chrome/Polished Brass or Polished Brass. Includes: 24" towel bar, paper holder, towel ring, and double robe hook.

**24<sup>81</sup>** #5394CB, #5394PB



**HARDWOOD CLASSICS 4-PC. OAK BATH SET**  
 Solid oak. Includes: towel bar, paper holder, single robe hook & towel ring.

**8<sup>94</sup>** #120024P

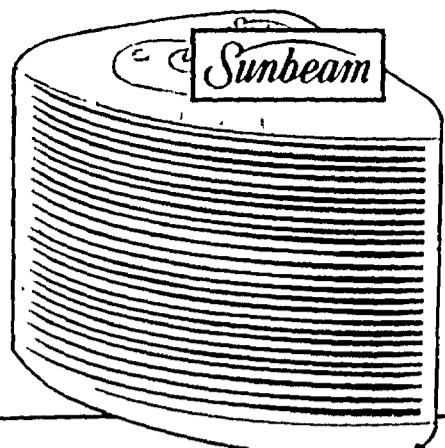

**HEPA AIR CLEANER** **\$79**  
 99.97% Pure air.  
 Cleans the volume of air in 10'x12' room every 10 minutes. Superior to Hospital grade filter. #2587

**HEPA-TYPE AIR CLEANER** **\$39**  
 95% Cleaner air.  
 Cleans the volume of air in 10'x12' room every 13 minutes. Hospital grade filter. 3 quiet speeds. 70 CFM. #2586

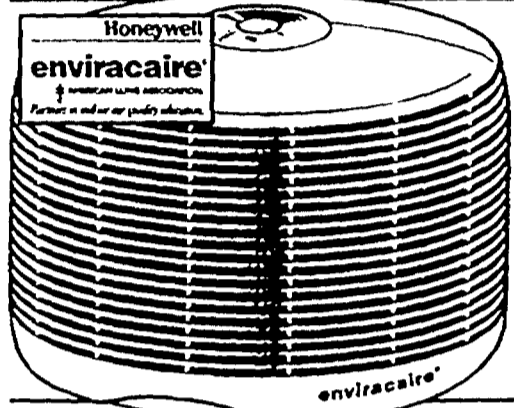
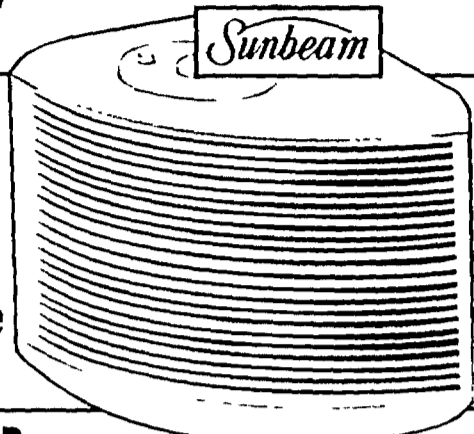

**2-SPEED HEPA AIR-CLEANER** **\$99**  
 True Hepa filtration (99.9% efficient). #1 choice of physicians (Riter, 1995 study). Cleans a 9'x 12' room every 10 minutes. Doctor recommended allergy relief. #10500

**TRUE HEPA 2-SPEED PORTABLE AIR PURIFIER** **\$134**  
 True Hepa filtration (99.9% efficient). #1 choice of physicians (Riter, 1995 study). Cleans a room 10'x14' up to six times per hour. #10700

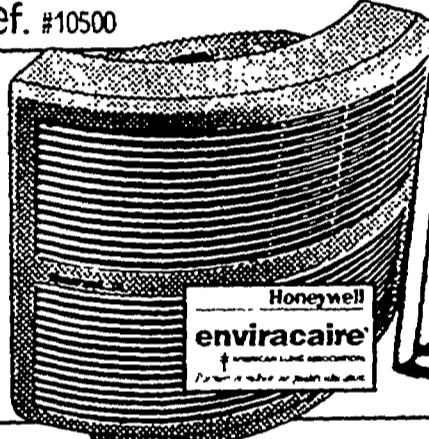

**BUMPER SPECIAL**

**Purolator**  
 Products Air Filtration Company

**DISPOSABLE FURNACE/AC FILTERS**

**3 FOR 99¢**

12X 24X 1	33¢
14X 25X 1	33¢
16X 20X 1	33¢
16X 25X 1	33¢
20X 20X 1	33¢
20X 25X 1	33¢



**20X 25 ELECTROSTATIC AIR FILTER** **\$29**  
 High performance electrostatic filter. Helps reduce causes of allergy symptoms. Washable-lifetime design.

16X 20	\$29
16X 25	\$29
20X 20	\$29

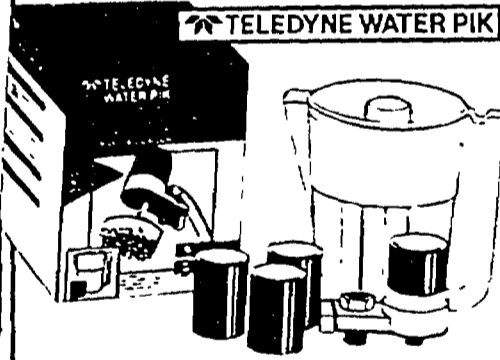

**FAUCET WATERFILTER PITCHER SYSTEM** **15<sup>97</sup>**  
 Includes- End-of-faucet filter, Replacement filters, Pitcher with lid. Filters out chlorine, bad taste & odors. #F6-B2



**Improve your home environment with these values.**

**UNDER-SINK FILTER W/INSTALLATION KIT** **\$22**  
 Reduces unpleasant taste & odor such as chlorine. 3/8" Connection for single-faucet applications. #158357

**ICEMAKER/WATER DISPENSER FILTER WITH QUICK-CONNECT KIT** **11<sup>50</sup>**  
 Granular-activated carbon reduces unpleasant taste and odor. #155348-72

**WATER CONDITIONING SYSTEM** **\$499**  
 Uses as much as 50% less salt than conventional water softeners. Softens up to 70 grains per gallon hard water. #93000

**SYSTEM SAVER WATER SOFTENER PELLETS** **3<sup>68</sup>**  
 99.5% pure salt. Makes your water cleaner & clearer. #1500

80 LBS	6.62
40 LBS	

**COUNTERTOP WATERFILTER** **\$29**  
 Enjoy clean fresh tasting water...for less than 1/7 the cost of bottled water. Proper cartridge selection provides reduction of taste & odor. #158334

**INSTAPURE™ FAUCET WATER FILTER CARTRIDGE** **3<sup>75</sup>**  
 Packed with more activated carbon than any comparable filter. #R-2C

**GIFT IDEAS VALUES FROM THE SQUARE!**

**SPECIAL SAVINGS ON GREAT GIFT IDEAS!**



**NOW ONLY 86¢**  
 WAS 96¢

**4 Pack Soft White Bulbs**  
 Soft, pleasing light. Great for any room in the house. Available in 40w, 60w, 75w, and 100w.

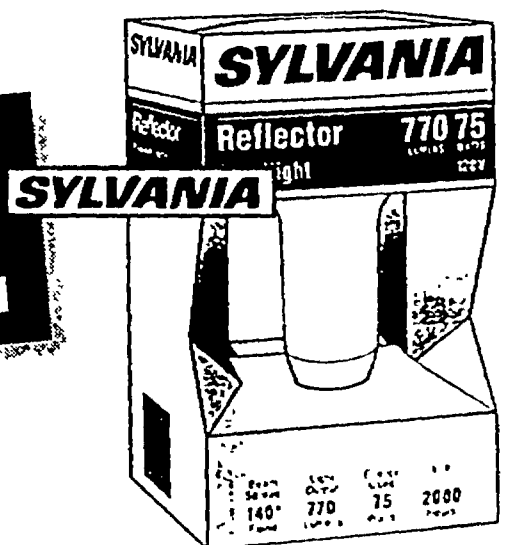

**75w Indoor Reflector Flood Light**  
 #15134/15133 **3.99**



**30w or 50w Indoor Flood Light**  
 Provides security with. Clear lens. Flood lamp has a wide beam. **3.44**

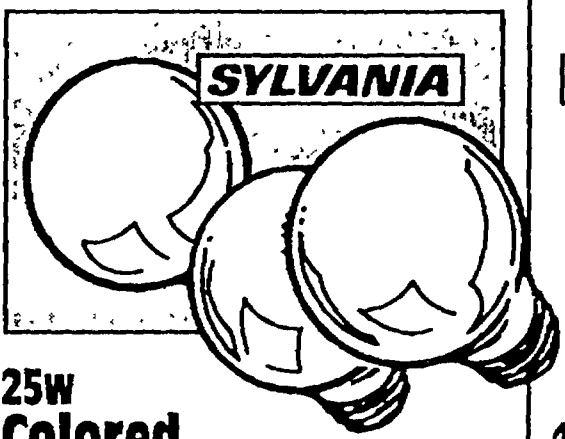

**25w Colored Light Bulbs**  
 Available in orange, green, yellow, red, and blue. **1.99 Each**

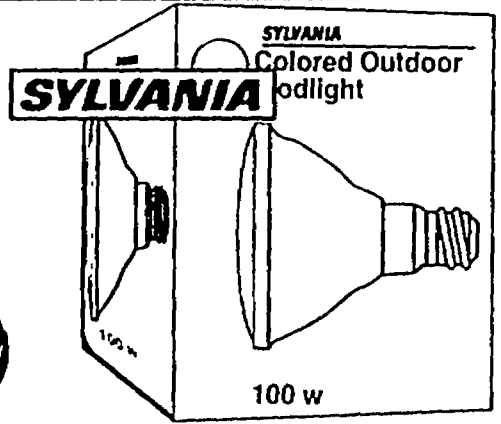

**100w Colored Flood Lamp**  
 Dramatize your home or garden with colored flood lamps. **6.99**



**Natural Light Halogen Bulb**  
 Last longer. **3.49**  
 #18960  
 #18965  
 #18970

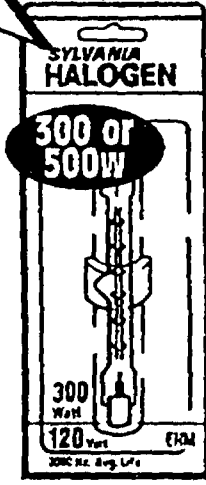

**Clear Halogen Double End Bulb**  
 120 Volt 2000 Hr. average life. **5.99**  
 #58920  
 #58865

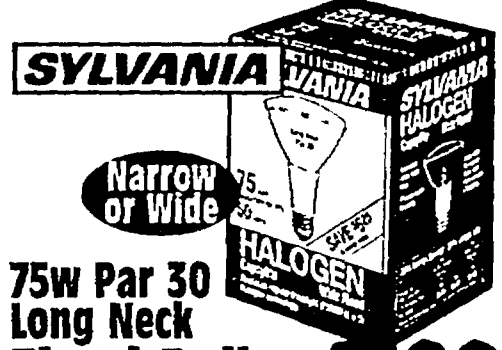

**75w Par 30 Long Neck Flood Bulb**  
 Brighter more natural lighting. **5.99**  
 #14824  
 #14823

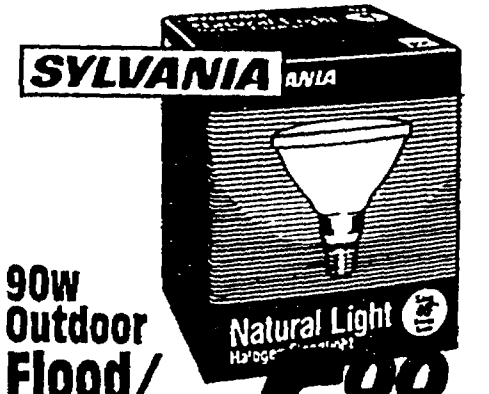

**90w Outdoor Flood/Spotlight**  
 Precise beam. **5.99**  
 #90PAR38/HAL/FL  
 #90PAR38/HAL/SP

**Energy saving fluorescents at money saving prices.**

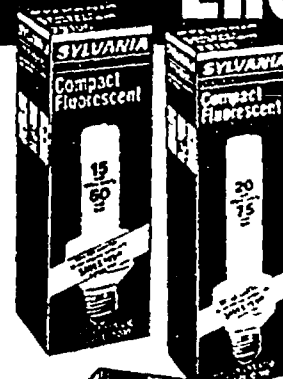

**Compact Fluorescent Light Bulbs**  
 Natural lighting. **9.99**  
 15 or 20 watt

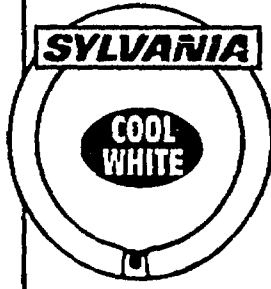

**22w Circline Fluorescent Lamp** #20148 **4.99**  
 8"

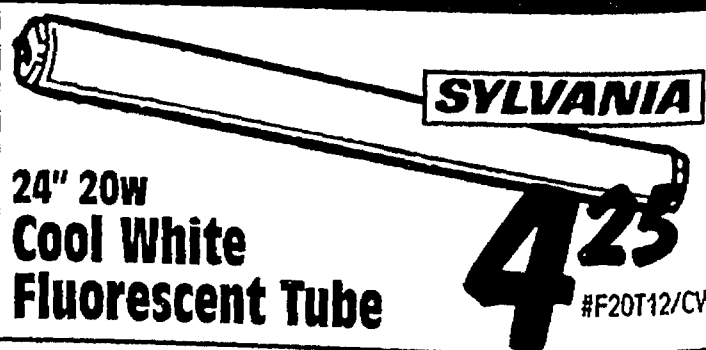

**24 inch 20w Cool White Fluorescent Tube** **4.25**  
 #F20T12/CW

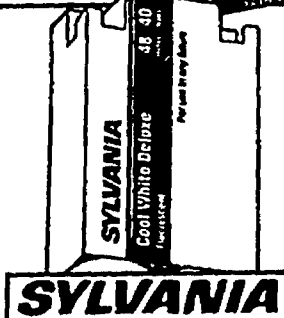

**4' Cool White Deluxe Fluorescent Lightbulb**  
 2 Pack **2.79**  
 #24475-  
 F40CW2PK

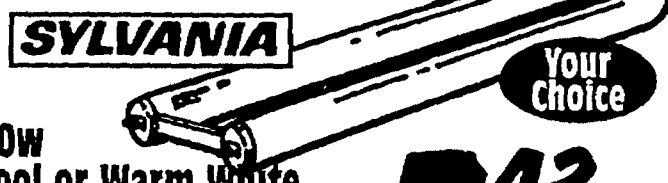

**40w Cool or Warm White U-Bend Bulb** **7.43**  
 #24046,  
 #24047

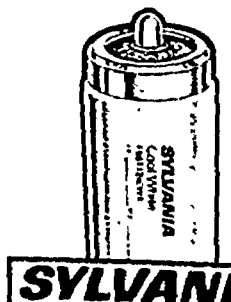

**8' 75w Cool White Deluxe Lightbulb**  
 Single Pin **3.99**  
 #29489

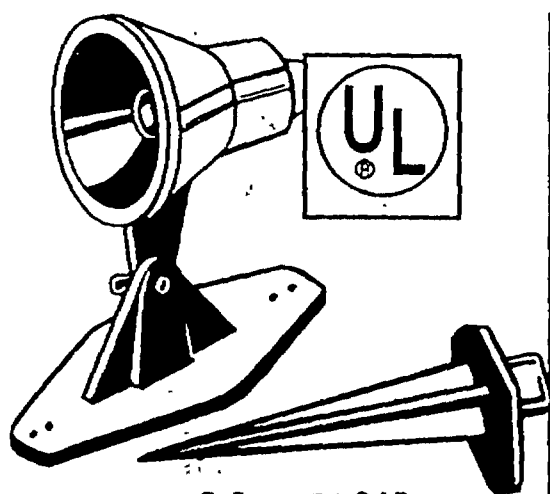

**Lamp Holder With 6' Cord**  
Can be mounted on walls, floors, or stake outdoors.

**768**  
#2380-006-GN

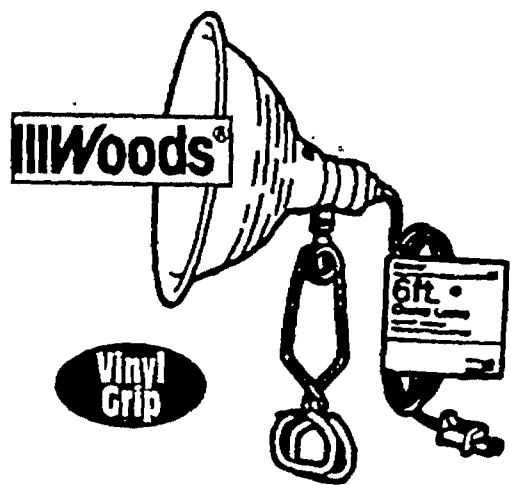

**Clamp Light With Reflector**  
Large vented aluminum reflector. 6 ft. cord and swivel clamp.

**596**  
#151



**6 Ft. Household Extension Cord**  
16 gauge/2conductors. Available in white or brown. Three polarized outlets with safety cover. For TV's, lamps, radios, etc.



**99¢**  
WAS 1.99

#8600  
#8601

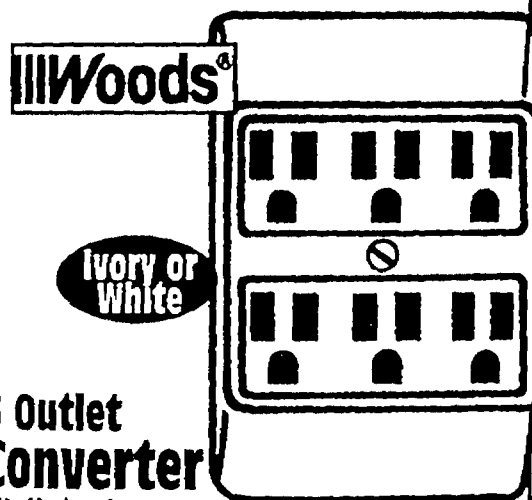

**6 Outlet Converter**  
UL listed. Converts standard grounded duplex to 6 grounded, 3 conductor outlets.

**275**  
#88796  
#88396

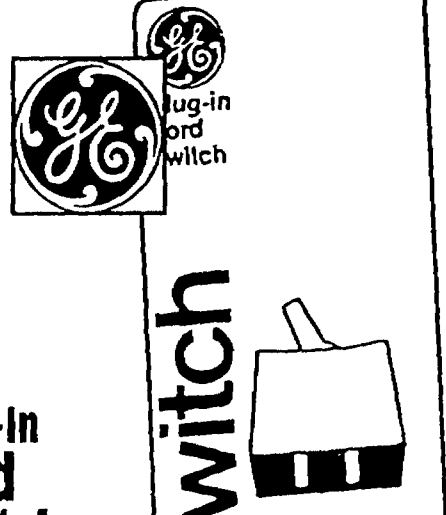

**Plug-In Cord Switch**  
Makes turning lights on and off easy. Saves wear and tear on cords.

**399**  
#GE5365-21D



**The Smart Clapper**  
Sound activated on/off switch.

**1995**  
#SM640-12

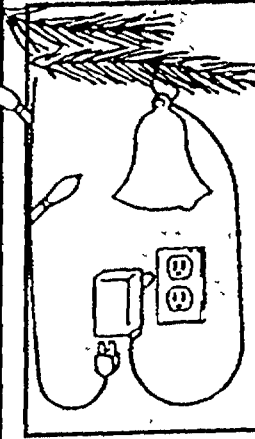

**Touch Light Control Ornament**  
4 light levels.

**1029**  
#A1225T

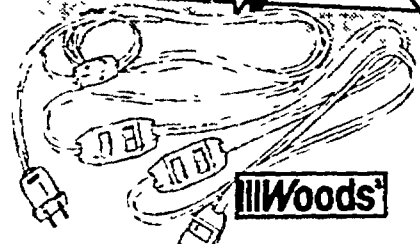

**15', 9 Outlet Christmas Tree Cord**

**621**  
#2189

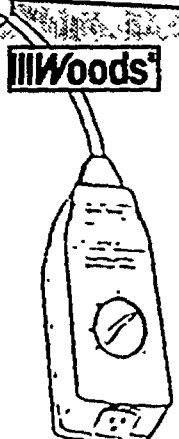

**Automatic Outdoor Photoelectric Timer**

**1411**  
#2001

**Save on everything to power up holiday decorations.**

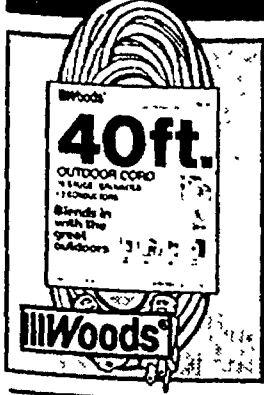

**40 Ft. Green Outdoor Extension Cord**  
16 gauge, 3 conductors. Grounded, U.L. listed.

**898**  
#8393

**80'**  
#8394  
**14.98**

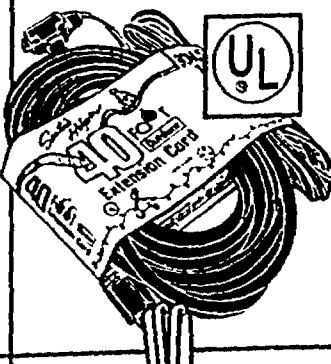

**40 Ft. Green Outdoor Extension Cord W/15' Interior Cube Tap Cord**

**1341**  
#2396

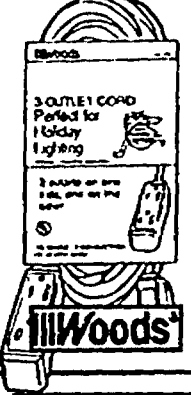

**16/3 Tri-Tap Green Extension Cord**  
20' 16 gauge. Convenient 3 outlets in a compact design.

**997** UL listed  
#873

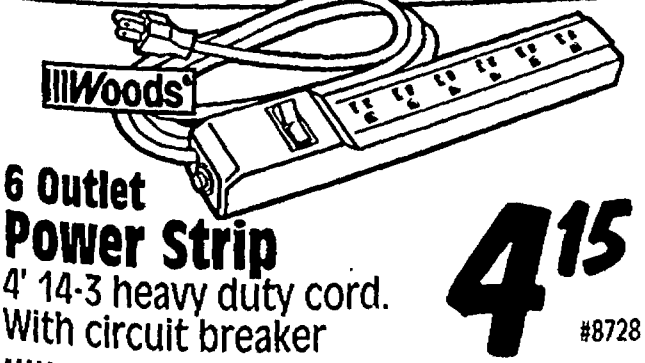

**6 Outlet Power Strip**  
4' 14-3 heavy duty cord. With circuit breaker

**415**  
#8728

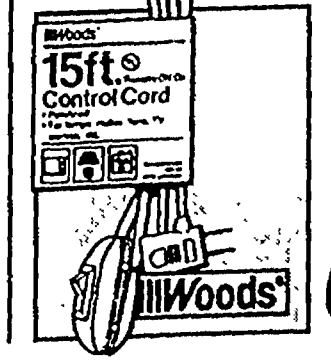

**15' Remote Control Cord**  
Polarized. For lights, lamps, radios, fans, etc.

**699**  
#8359W

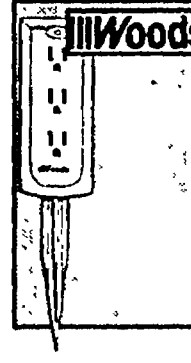

**3 Outlet Outdoor Power Stake**  
3 grounded outlets. 25' cord

**1499**  
#2429

**GIFT IDEA VALUES FROM THE SQUARE!**

**SPECIAL SAVINGS ON GREAT GIFT IDEAS!**



**SPRED SATIN LATEX FLAT**  
Washable finish. Ideal for walls and ceilings.

**NOW ONLY**

**9.25**

GALLON

~~WAS 9.98~~

**5 GALLON \$45**



**RENAISSANCE INTERIOR ACRYLIC LATEX FLAT** **18.99** GAL.  
Superior quality provides durable, washable finish.

**RENAISSANCE INTERIOR ACRYLIC LATEX SATIN** **19.99** GAL.  
Rich low luster finish. One coat coverage.

**RENAISSANCE INTERIOR ACRYLIC LATEX SEMI-GLOSS** **21.99** GAL.  
Medium sheen finish. One coat coverage.

**INTERIOR LATEX SATIN WALL PAINT** **11.21** GAL.  
One coat coverage. 10 year warranty. **5 GALLON 53.75**

**INTERIOR LATEX SEMI-GLOSS** **11.59** GAL.  
One coat coverage. 10 year warranty. Water clean up. **5 GALLON 53.95**

**SPRED EGG SHELL** **13.97** GAL.  
Exceptional covering power. Stain resistant finish. Perfect for childrens rooms. **5 GALLON 64.85**

**We offer FREE custom color matching and paint mixing!**



**KITCHEN & BATH SEMI-GLOSS ENAMEL PAINT** **18.58** GAL.  
Long lasting durability.

**KWIK-START LATEX WALL PRIMER** **9.99** 1 GALLON  
**17.99** 2 GALLON  
Primes/seals drywall and sheetrock.



**KWIK SEAL TUB & TILE CAULK**  
Mildew resistant. Excellent adhesion. Available in almond, bright white, and clear.

**1.97** 5.5 OUNCE

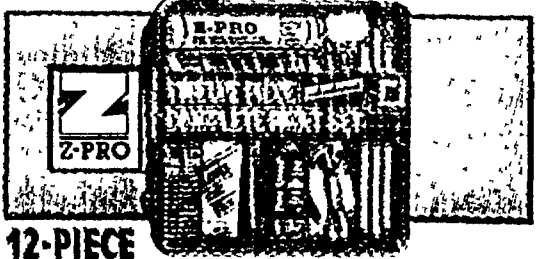

**12-PIECE PAINT SET** **9.99** #7712  
Extra large paint tray  
5 wire roller frame.  
2" Trim brush. 3" mini trim roller.  
9'x 12' Clear drop cloth. Putty knife.

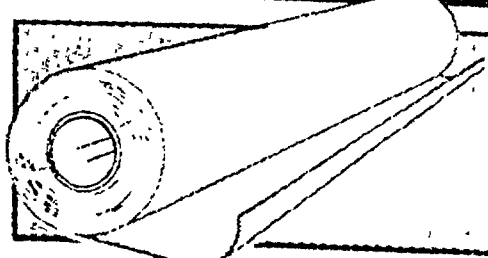

**10x25x.004 POLYETHYLENE SHEETING** **4.71**  
Your Choice clear or black.  
#10x25x 004C



**HEAVY DUTY POLY TARP** **8.91** 9x12  
For home, garden or industrial use.  
#09X12P-409112

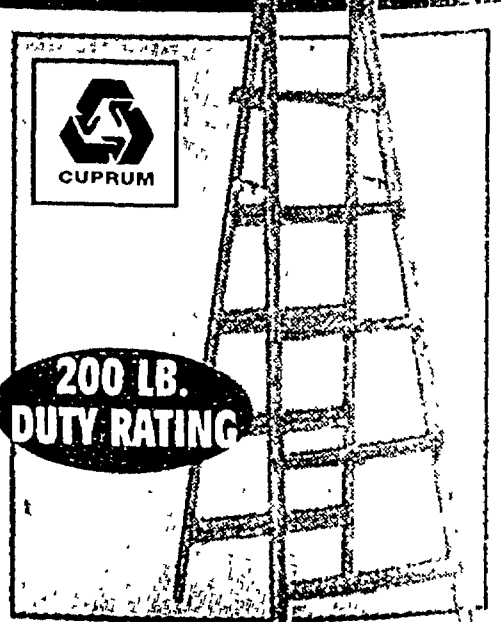

**200 LB. DUTY RATING**  
**6-FOOT TYPE III HOUSEHOLD WOOD STEP LADDER** **26.91**  
Handy shelf-lock spreader system. Sturdy, fully rodded beam-braced back legs. #WS-30006



**OIL BASED ENAMEL**

Covers fast with fewer coats, delivering more for our money.

**5<sup>95</sup>** 1 QUART  
**19.89** 1 GALLON

**AMERICAN ACCENTS ENAMEL**

Use on masonry, metal, plastic, & more.

**2<sup>59</sup>** 12 oz.

**RUST TOUGH**

Durability of an oil paint. Soap and water wash-up of latex. No primer needed.

**5<sup>28</sup>** QUART



**POLYURETHANE**

Long lasting durable finish. Easy-to-apply, easy-care.

**8<sup>36</sup>** 1 QUART  
**19.99** 1 GALLON

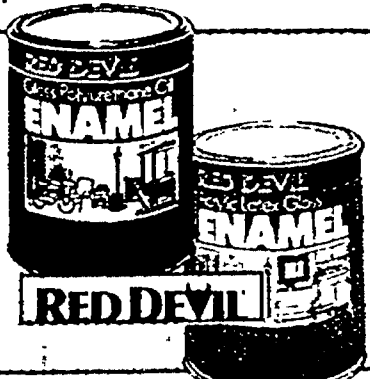

**POLYURETHANE OR ACRYLIC LATEX GLOSS ENAMEL**

Exterior and interior.

**5<sup>49</sup>** 1 QUART  
**18.69** 1 GALLON  
YOUR CHOICE!



**POLYURETHANE OR ACRYLIC LATEX GLOSS ENAMEL**

Top quality enamels.

**5<sup>28</sup>** 1 QUART  
**YOUR CHOICE!**

**BUNDLE SPECIAL**

**Zynolyte**  
All-Purpose Spray Enamel  
INTERIOR/EXTERIOR  
Fast Drying Prevents Rust  
MADE IN U.S.A.

**CHRISTMAS SPRAY PAINT**  
Fast drying. Prevents rust. Available in red, green, gold, silver, black and white

9x12 1 MIL PLASTIC DROP CLOTH **1.14**

**NOW ONLY 98¢**

**We make all your holiday paint projects affordable!**



**LIVING COLOR SPRAY LATEX GLOSS**  
Latex enamel spray paint. Durable high gloss finish. Soap and water clean up. Low odor. Choose from 5 unique colors collections.  
**3<sup>97</sup>** 12 oz.



**STONE CRAFT™ DECORATIVE PAINTS KITS**  
Create beautiful stone-textured surfaces to accent lamps, planters, pottery, etc. in two easy steps. Base coat provides an elegant stone textured on wood, metal, plastic, ceramic, & painted surfaces.  
**8<sup>65</sup>** 12 oz.



**FORMBY'S GRANITE FINISH**  
Textured stone finish gives the appearance of stone. Easy 1 step spray application.  
**7<sup>99</sup>** 12 oz.



**A. 2" x 60 YD. TARTAN MASKING TAPE** **2<sup>19</sup>**  
**B. 9" x 11" ALUMINUM OXIDE SANDPAPER**  
Sands a wide variety of materials. **2<sup>19</sup>**



**PREP & PAINT GLOVE**  
Seamless stretch vinyl body won't split or leak, conforms for a snug, sensitive fit. Treated interior helps gloves slide on and off easily and absorbs perspiration.  
**3<sup>99</sup>** MEDIUM LARGE **3.99**



**EZ PAINTR ARTIST BRUSH SET** **3<sup>96</sup>** 5-PC.  
For crafts, hobbies and touch-ups.  
#7004250103 **3-PIECE 3.96**

**GIFT IDEAS/VALUES FROM THE SQUARE!**

**SPECIAL SAVINGS ON GREAT GIFT IDEAS!**

# 10% OFF all ceiling fans!

IN STOCK ONLY - WHILE QUANTITIES LAST













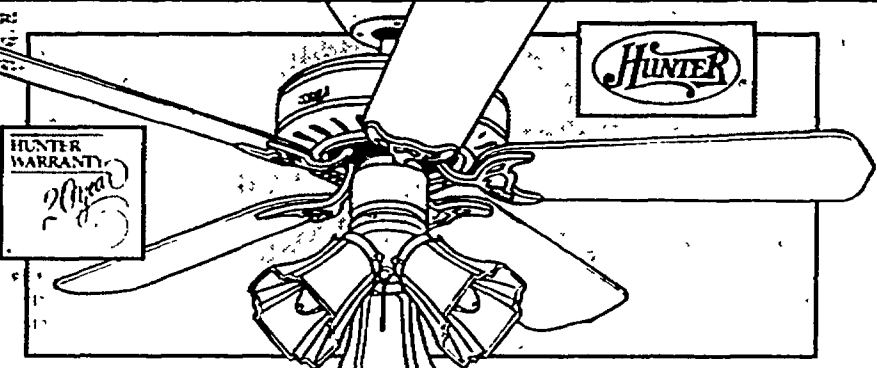

**42" SHOWCASE-SERIES V**  
Installer's Choice® mounting system. Antique or polished brass, white, verde or rust. #212-00,03,04,06,07

62<sup>99</sup>

**BUILDERS SQUARE**

**INSTALLS CEILING FANS**

**\$59** LABOR ONLY. JOB CODE #0301.

NORMAL INSTALLATION

#TACLA001191C, #62623, #PC81017705, #105954, #2102085035, #TACLB002928C, #210208503, #TACLA000876, #MNO006039, #0003812M4, ICT#1481, 3208, 2888, 2728

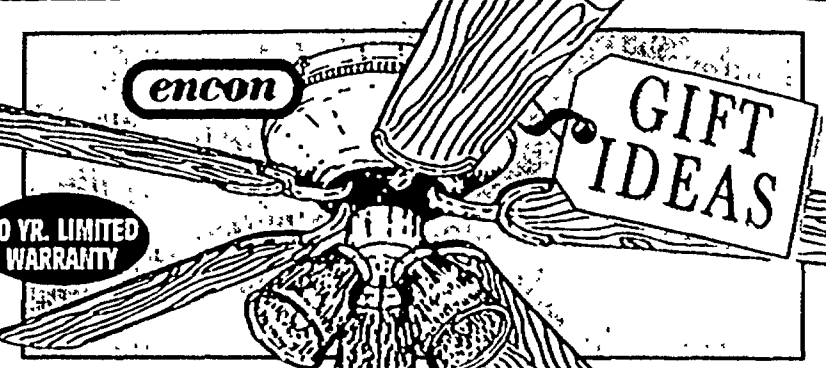

**52" CONTEMPRA**  
Includes Genie remote control system. White, antique or polished brass. #5CPR52-ABP,PBP,WHD

71<sup>99</sup>

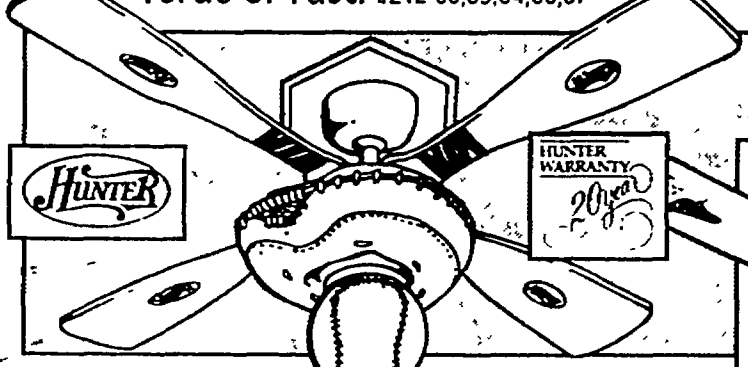

**44" BASEBALL FAN**  
Detailed catcher's mitt motor housing. Reversible "bat" blades. #21841

71<sup>96</sup>

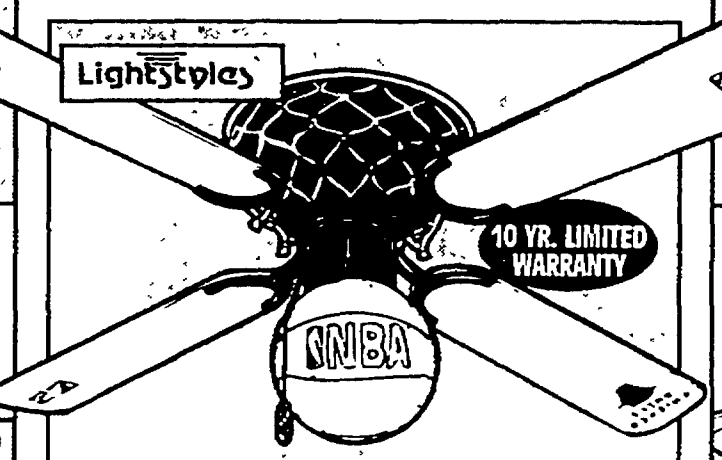

**30" PETITE HUGGER**  
Great for small areas like bathrooms or kitchens. Light fixture inc. #6CP30WHM

26<sup>34</sup>

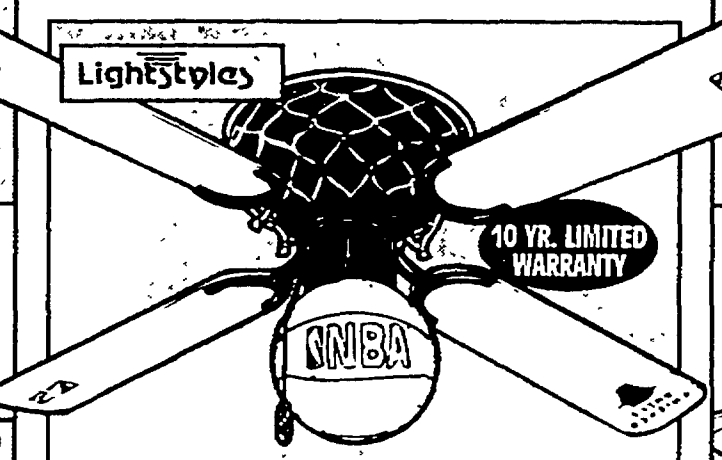

**52" NBA FAN**  
Includes 2 sets of color NBA team logos. Combo blades. 3-speed. #0301-00

80<sup>99</sup>

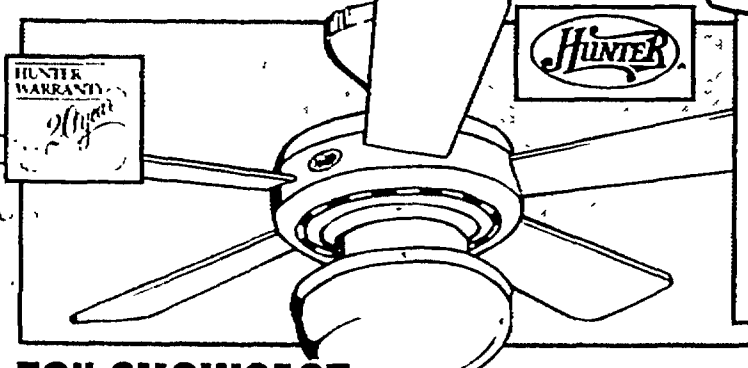

**52" SHOWCASE SERIES XIV** Mid-body blade design. Installer's Choice® system. PB, black or white. #214-64,65,66

152<sup>10</sup>

**...and many more styles and finishes to choose from!**

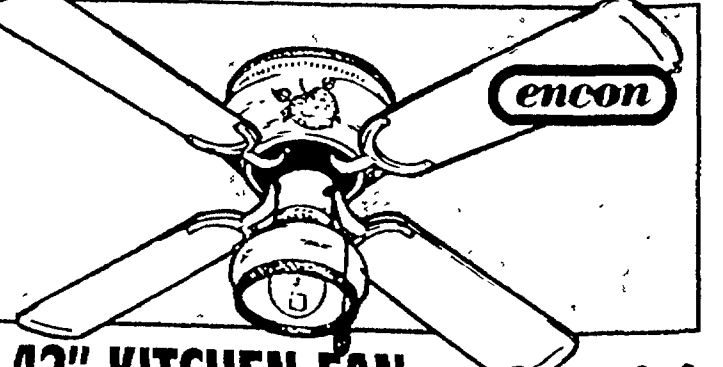

**42" KITCHEN FAN**  
Flush mount. White with fruit decals. #KF42-FHD,DFD

35<sup>96</sup>

## Plus 10% off light kits and controls!

**SAVE on all ceiling fan light kits in stock!**

We offer a huge selection of light kits in many decorative styles and finishes!

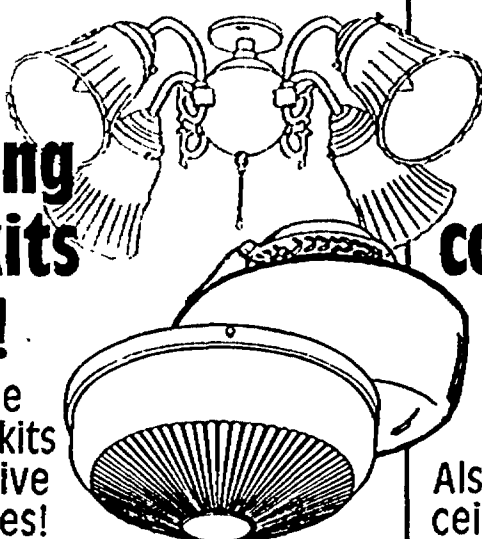

**SAVE on remote controls, wall switches and more!**

Also, save 10% on other ceiling fan accessories!

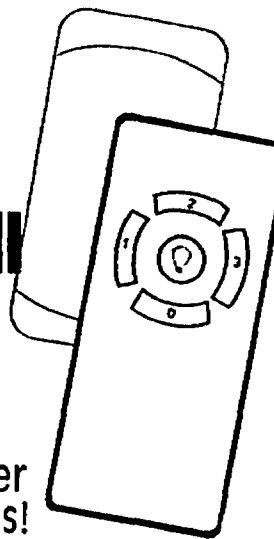

**SMART FAN BULB**  
4 light levels at the flick of a switch.

**3.98** R-20 60 WATT #71527

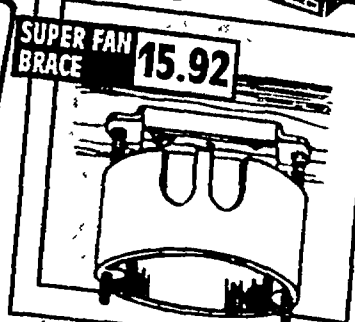

**INSTALLATION KIT**  
Fan brace. Can install against any surface.

**13.86** UL APPROVED #33300



**GIFT IDEA VALUES FROM THE SQUARE!**

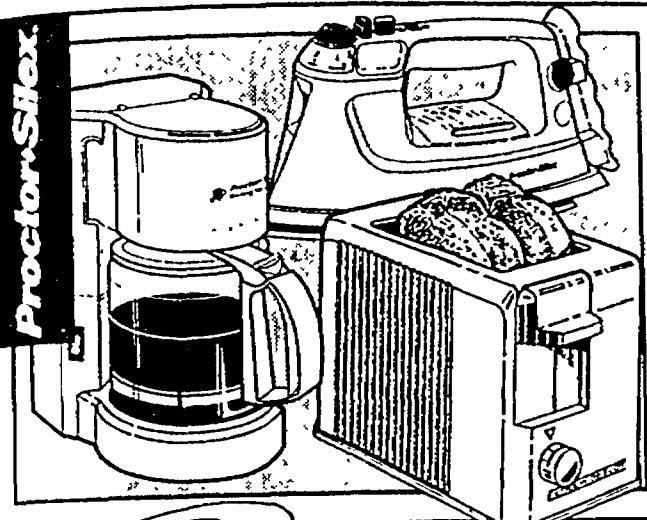

**12 CUP COFFEEMAKER**  
Morning Maker.™ #42301  
**PLUS™ IRON**  
Full size, ultra steam. #18300  
**2 SLICE TOASTER**  
Extra wide slots. #T4300  
**19<sup>99</sup>**  
YOUR CHOICE!

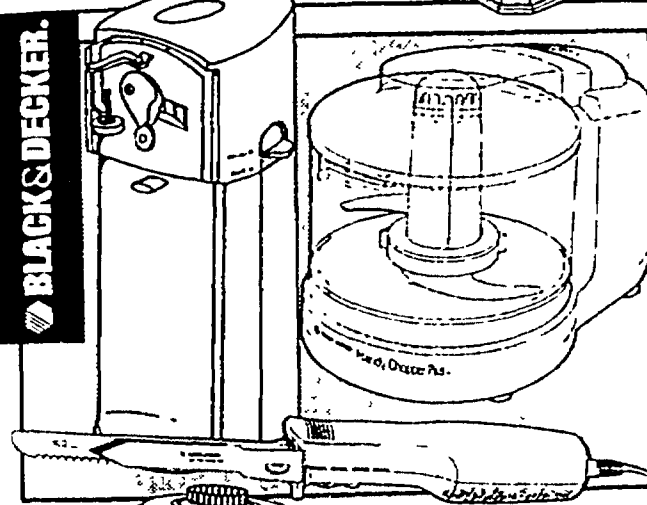

**HIDEAWAY™ CAN OPENER**  
Built-in knife sharpener. #EC500W  
**HANDY CHOPPER PLUS™**  
Mincer and chopper. #HC3000  
**ELECTRIC KNIFE**  
Slice Right™ w/cutting guide. #EK300  
**19<sup>99</sup>**  
YOUR CHOICE!

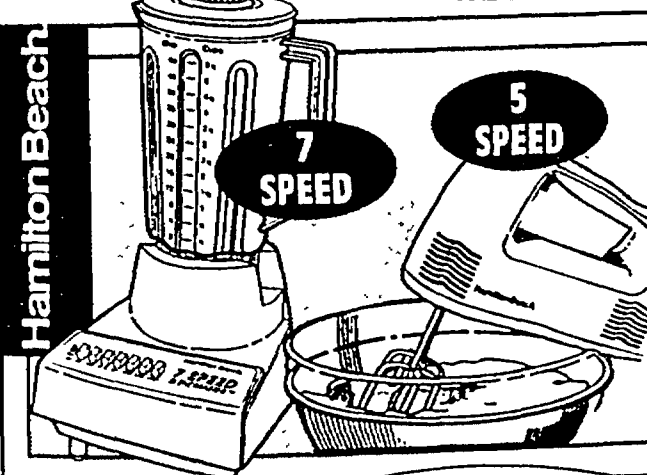

**7 SPEED BLENDER**  
44 oz. Pulse speed. Easy to care and clean. #600WP  
**BOWL REST™ MIXER**  
200 watt hand mixer. #62580  
**19<sup>99</sup>**  
YOUR CHOICE!

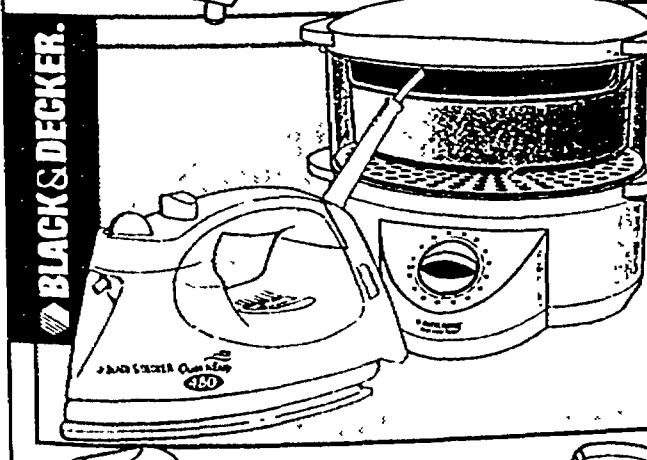

**QUICK 'N EASY™ IRON**  
Automatic shut-off. #X480  
**FLAVOR SCENTER STEAMER™**  
Food/rice cooker. Steams w/ out adding fats, calories. #HS2000  
**29<sup>99</sup>**  
YOUR CHOICE!

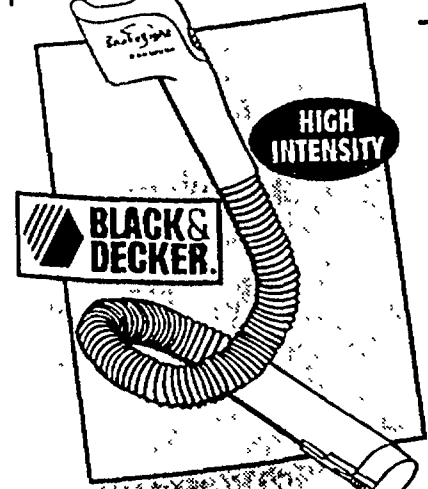

**SNAKE LIGHT**  
Flexible core for hands free lighting. Includes 2 batteries and spare bulb.  
**19<sup>96</sup>** YOUR CHOICE!  
BLACK OR WHITE  
#SL-B1M0,W10

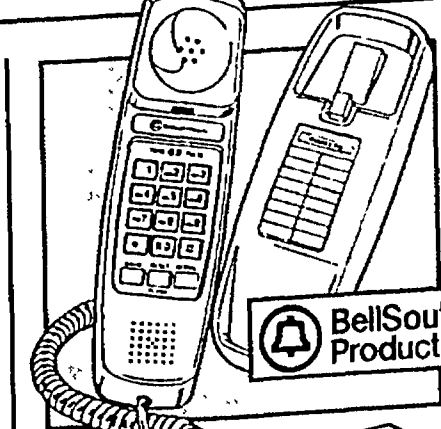

**TRIMLINE PHONE**  
Lighted keypad. Mounts on wall or desk. #4431,BL  
**12<sup>99</sup>**  
IVORY OR BLUE

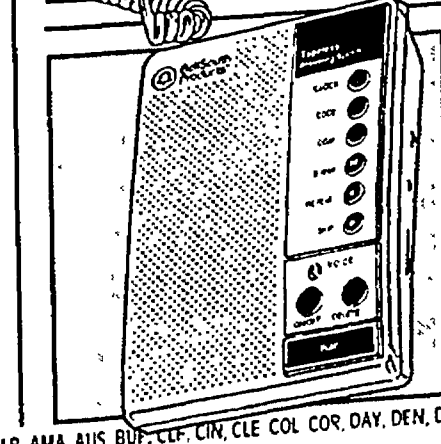

**DIGITAL ANSWERING MACHINE**  
**49<sup>99</sup>**  
#1190

**BREAD SPECIAL**

**GoldStar**

**1.5 LB. AUTOMATIC BREAD MAKER**

Loaf size: 1.0 & 1.5 lbs. 100% whole wheat and more. Viewing window. Hold warm cycle. Crust baking control. #HB-152CE

**79<sup>96</sup>**

WITH \$10 MAIL-IN REBATE  
**REG. 89<sup>96</sup>** WITHOUT REBATE

**LOWEST PRICE EVER! (AFTER REBATE)**

**GIFT IDEAS**

**GoldStar**

**COMPACT MICROWAVE**  
0.6 cu. ft. interior cavity. Turntable cooking system.

**\$89** 600 WATTS #MA6802

0.9 CU. FT. #MA960M **129.95** 1.2 CU. FT. #MA1280M **139.95**

**Energizer**

**BATTERIES**

- "AA" BATTERY w/TESTER 8 PACK #E91BP-8TP..... **5.49**
- "C" BATTERY w/TESTER 4 PACK #E93BP-4TP..... **4.65**
- "D" BATTERY w/TESTER 4 PACK #E95BP-4TP..... **4.65**

**YOU COULD WIN**

**A \$1,000 SHOPPING SPREE!**

Come in today and enter the **Builders Square Energizer Sweepstakes!** See store for details.

**SPECIAL SAVINGS ON GREAT GIFT IDEAS!**

**SPECIAL**

**2 PC. SHOWCASE COLLECTION**  
Bronze wrought iron floor and table lamp. Kraft or white shade.

**Design Craft**

**NOW ONLY**  
**59<sup>99</sup>**  
#D9039-00,99  
**WAS 69<sup>99</sup>**

**GIFT IDEAS**

**DANA**

**300 WATT HALOGEN FLOOR LAMP**  
Height 72", includes halogen bulb. Hi/lo switch. Frosted green acrylic accent at base of shade. #7003-BL,WH

**14<sup>96</sup>**  
**YOUR CHOICE!**  
BLACK OR WHITE

**TAUPE, GREEN OR BURGUNDY**  
#7004-BC,HC,TA **19<sup>99</sup>**

**SPECIAL**

**3 PC. LAMP ENSEMBLE**  
Floor lamp and twin table lamps. Pleated fabric shade. Ivory or hunter green accents.

**DANA**

**NOW ONLY**  
**69<sup>99</sup>**  
#9080-IV,HC  
**WAS 79<sup>99</sup>**

**SOLID BRASS**

**DANA**

**TOUCH LAMPS**  
A variety of stylish lamps to choose from.  
#70-80,81,70-96G,96B

**12<sup>99</sup>**  
**CERAMIC TABLE LAMP #707588**

**19<sup>99</sup>**  
**YOUR CHOICE!**

**CATALINA**

**GOLD ACCENTS**

**CHERUB LAMP**  
Cream finish. Egg linen shade.  
#4-18-40372

**39<sup>99</sup>**

**CATALINA**

**CLOCK LAMP**  
Honey oak. Quartz clock. Canvas shade.  
#4-18-40474

**39<sup>99</sup>**

**CATALINA**

**3 PC. TIFFANY GIFT PACK**  
Lamp with matching frame & box.  
#2995

**44<sup>99</sup>**

**CATALINA**

**This item is Special ORDER**

**Lightstyles**

**10% off**  
Our Everyday Low Price!

**TABLE LAMPS**

**GIFT IDEAS**

**ASSORTED CLOCKS**  
Precision quartz accuracy. Easy set controls on back. Cordless. Choose between - A. bedside alarm, B. solid wood mantel or C. wood mantel. #Q485-03,Q444-62,Q48A

**19<sup>99</sup>**  
**YOUR CHOICE!**

**W/BUILT-IN FLASHLIGHT**

**Save on gifts they'll really use!**

**PanelCraft**

**UNFINISHED JIFFY BOOKCASE**  
36"h x 36"w x 9"d. Interlocking bookcase is quick to assemble.

**12<sup>10</sup>**  
**4 SHELF ASSEMBLES WITHOUT NAILS, GLUE OR TOOLS**  
#37

**DORFILE**

**EASY CARE FINISH**

	24"	36"	48"
8"	3 <sup>05</sup>	3 <sup>47</sup>	4 <sup>79</sup>
10"	3 <sup>09</sup>	4 <sup>69</sup>	5 <sup>19</sup>
12"	3 <sup>97</sup>	5 <sup>54</sup>	6 <sup>57</sup>

**LAMINATE SHELF**  
White. Resists warping.

**DORFILE**

**EASY TO INSTALL**

**GLASS SHELVING**  
White accents. Clear, tempered glass. #3355182505

**10<sup>97</sup>**  
**WHITE SUPPORT**

**GIFT IDEAS VALUES FROM THE SQUARE!**

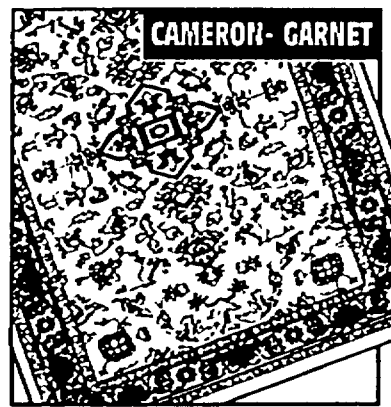
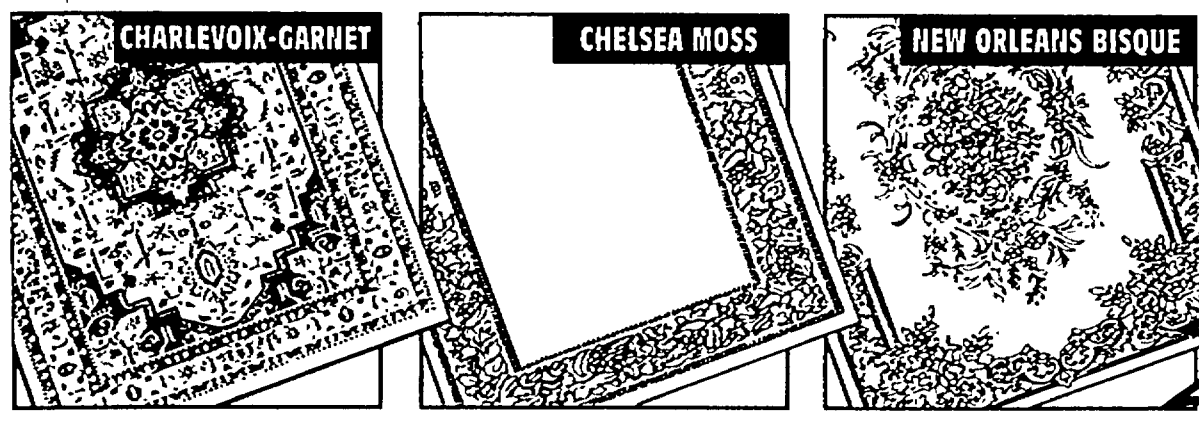

**3'11" X 5'8" AREA RUGS**  
 Manufactured from premium Perma Color fiber for years of durability and beauty. A variety of styles to choose from. #3x30101800, 4100, 2300, 6800

**\$45 YOUR CHOICE!**

5'3" X 8'1"	89 <sup>97</sup>
7'10" X 11'5"	179 <sup>97</sup>

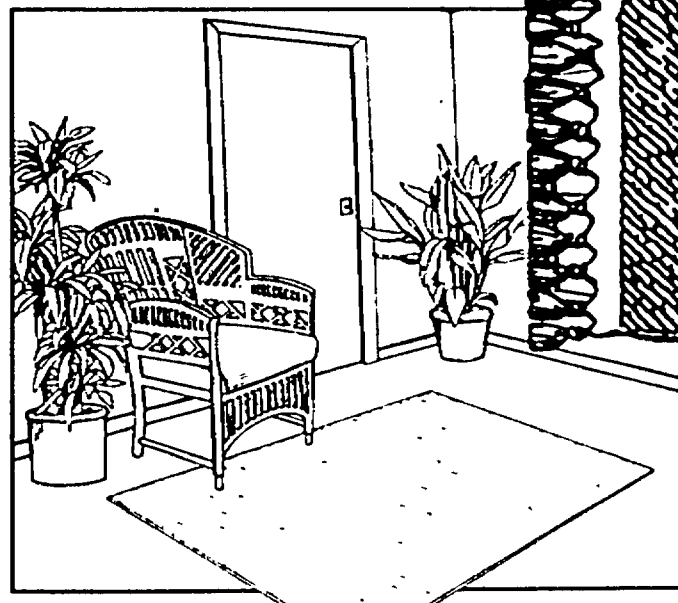

**BERBER RUG**  
 Fringed, dense thick carpet. Action back.  
**\$49** ASSORTED COLORS #FB69SWP

**LEVEL LOOP RUG**  
 Assorted quality carpets.  
**\$24** #RL695-A 6' X 9' COLOR COORDINATED FINISHED EDGES

**22" X 40" THROW RUG**  
 Premier Jacquard rug. Machine washable. New "Select" patterns. 3 styles to choose from. #15479-59, 15484-91, 15453-42  
**NOW ONLY 2.98<sup>EA.</sup>**  
 100% COTTON  
 WAS 4<sup>96</sup>

**A warm welcome at budget prices.**



**18" X 30" DECORATIVE COCO FIBRE MAT**  
 Handmade of the finest Coir in India. #05-31830, 42830  
**9.97** 100% NATURAL

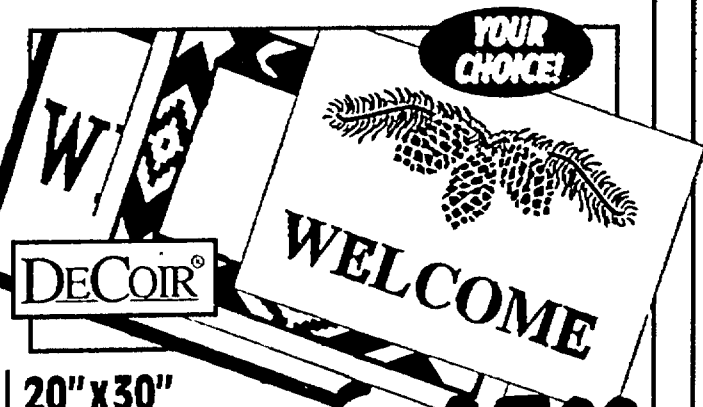

**20" X 30" COCO DOOR MAT**  
 Coir fibers, made in USA. Vinyl back. #836-18, 21, 96  
**15.99**

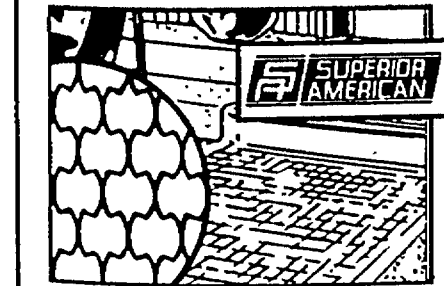

**27" RUNNER**  
 For protection on any carpet. Patterned. #MPR  
**95¢ PER LN. FT. CLEAR VINYL**

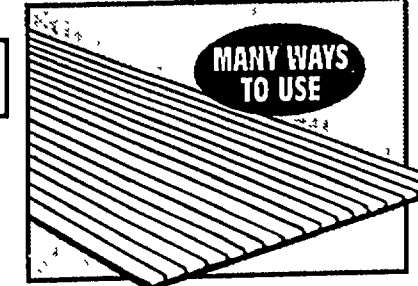

**27" TOPPER RUNNER**  
 Long wearing, indoor/outdoor. Easy to clean.  
**2.08** RESISTS FADING, MOLD & MILDEW #2824271092, 1041, 1093

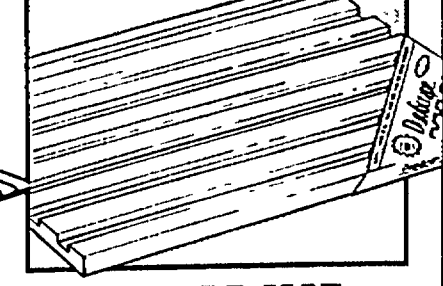

**ASTROTURF MAT**  
 Multi-level surface. Slip resistant backing. #PL166  
**15.87** 23" X 35-1/2" HUNTER GREEN OR AUTUMN GOLD



**BOSS VICTORY UPRIGHT VACUUM**  
 Lightweight and reduces cleaning effort. Automatic attachment conversion. On-board cleaning attachments. Quiet operation. Back Saver™ handle reduces bending. #4335  
**99.99** CLEAN AIR DESIGN, BUILT-IN MOTOR FAN PROTECTION

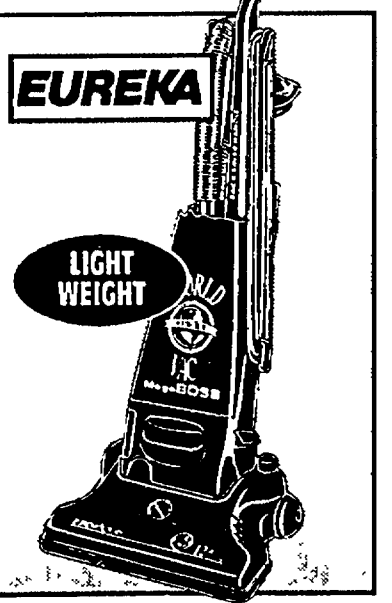

**MEGA BOSS® WORLD VAC® VICTORY UPRIGHT VACUUM**  
 Extra wide 15" cleaning path. Micron filtration system. Clean air design with built-in motor fan protection system. Reduces cleaning effort. #4460AT  
**139.99** QUIET OPERATION, UL LISTED

Products shown are representational of selection. Styles, patterns, sizes and/or colors may vary by store, please see your store for selection. PAGE 29 - ALL MKTS - 11/28/96

**SPECIAL SAVINGS ON GREAT GIFTS IDEAS!**

# Save on Gifts for the Gardener



**BLACK & DECKER**  
**SUPER VAC 'N MULCH**<sup>®</sup>  
 WITH SHOULDER BAG KIT  
 Air speeds up to 180 mph and 480 cfm air flow for fast blowing and efficient vacuuming. #BV1000

**SAVE \$5 COUPON**  
 See Store for Details.

**64<sup>97</sup>**

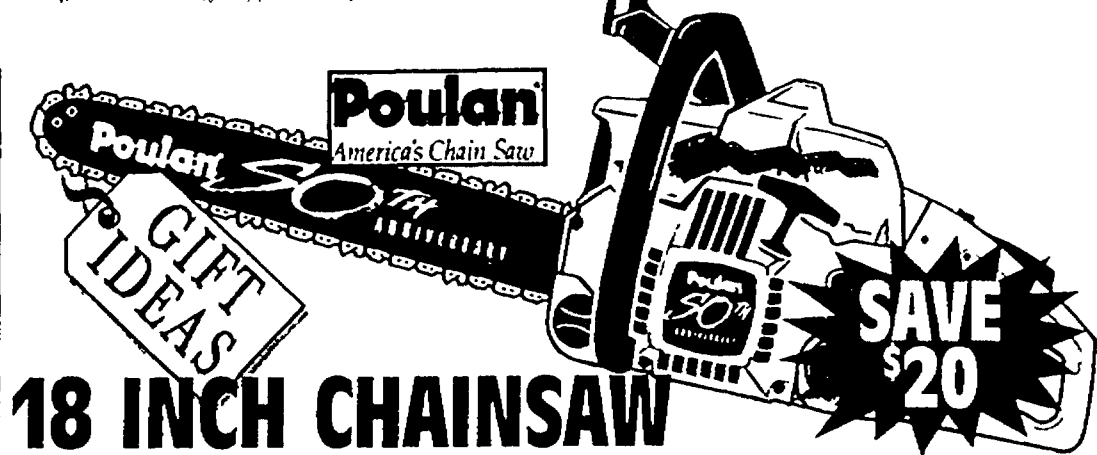

**Poulan**  
 America's Chain Saw  
**18 INCH CHAINSAW**  
 50TH ANNIVERSARY SPECIAL EDITION  
 SuperClean™ air filter system for longer engine life and less maintenance. 18" Sprocket-nose, reduced-kick guide bar. Extra chain included. #952801700

**SAVE \$20**

**\$139**

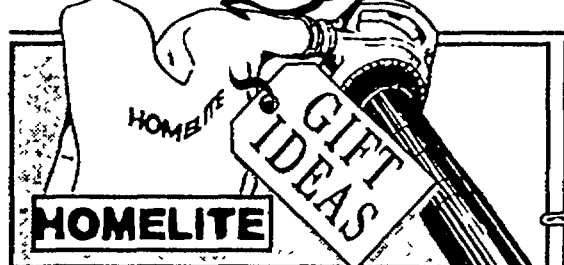

**HOMELITE**  
**GAS BLOWER/VAC**  
 25cc. Vacuum/mulch/bag in one easy step. #HB-180V

**99<sup>97</sup>** **SAVE \$10**



**HOMELITE**  
**ELECTRIC BLOWER**  
 110 mph/maximum air velocity. #2510GS

**Super-blower Vac #2595 64.97** **29<sup>88</sup>**



**Poulan**  
**14 INCH ELECTRIC CHAINSAW**  
 2 HP. 10.5 AMP motor. #1420

**16 INCH #1625 \$67** **\$59**

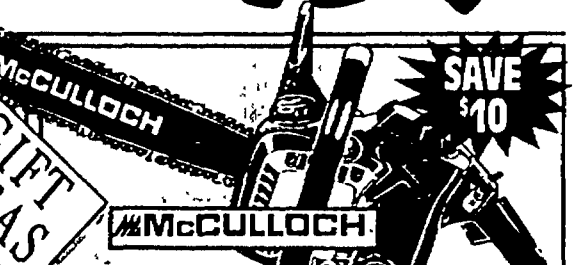

**McCULLOCH**  
**16 INCH CHAINSAW WITH CASE**  
 32cc engine. 16" sprocket tip cutting bar. #11600032-43  
 While quantities last. Sorry, no rainchecks.

**139<sup>99</sup>**

## Affordable gifts for gardeners are at the POWER SQUARE!

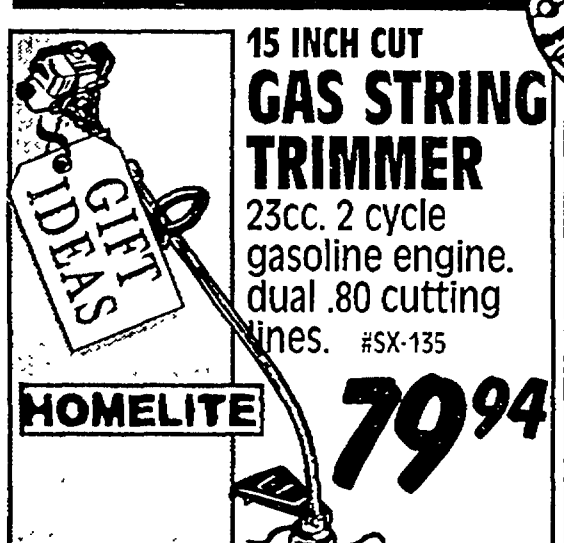

**15 INCH CUT GAS STRING TRIMMER**  
 23cc. 2 cycle gasoline engine. dual .80 cutting lines. #SX-135

**79<sup>94</sup>**

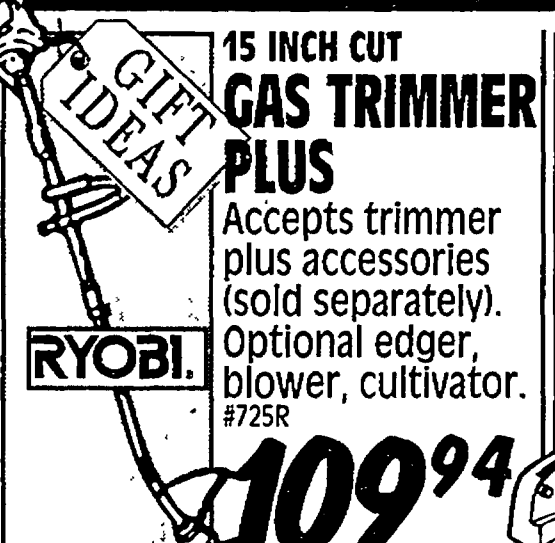

**15 INCH CUT GAS TRIMMER PLUS**  
 Accepts trimmer plus accessories (sold separately). Optional edger, blower, cultivator. #725R

**109<sup>94</sup>**

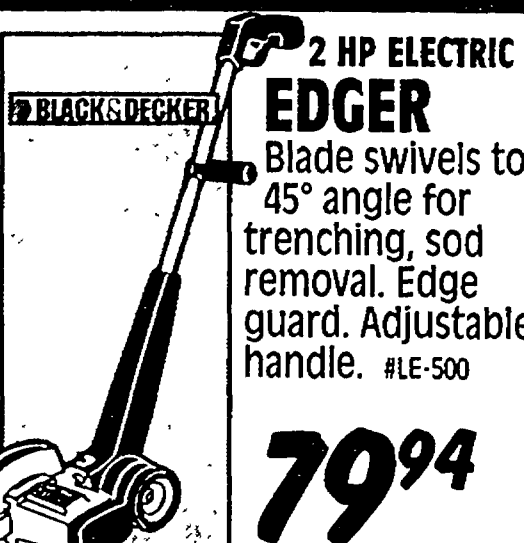

**BLACK & DECKER**  
**2 HP ELECTRIC EDGER**  
 Blade swivels to 45° angle for trenching, sod removal. Edge guard. Adjustable handle. #LE-500

**79<sup>94</sup>**



**BLACK & DECKER**  
**16 INCH HEDGE TRIMMER**  
 Universal gear-driven motor delivers powerful, reliable performance. #TR165

**32<sup>97</sup>**

## Great values for your green thumb expert.

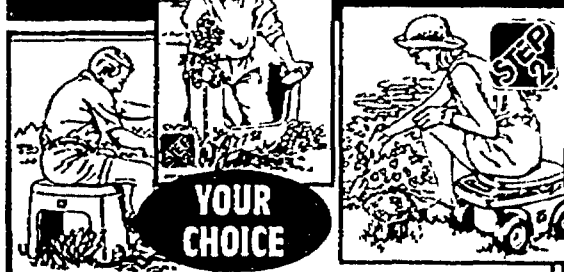

**GRASSHOPPER WORK SEAT OR EASY-UP KNEELER & SEAT**  
 Choice from grasshopper work seat that rolls easily or kneeler & seat which eliminate knee pains and grass stains. #5400, #55050

**19<sup>99</sup>**



**CORONA**  
**COMFORT HAND TROWEL, TRANSPLANTER OR CULTIVATOR**  
 All hand tools are lightweight with polished aluminum alloy. #ST3010C, #CT3020C, #CT3030C

**6<sup>99</sup> YOUR CHOICE**



**WALLACE**  
**ANVIL OR BY-PASS PRUNER**  
 Both have 1/2" cutting capacity. Lifetime warranty and rust resistant blades. Soft grip. #7924-6981 #7923-6981

**8<sup>77</sup> YOUR CHOICE**



**TRUE TEMPER**  
**REAL TOOLS FOR KIDS**  
**POLY LEAF RAKE, HOE, SHOVEL OR GARDEN RAKE**  
 Smaller than adult tools but last just as long. Strong lacquered hardwood handles. #KLRO, #KHM, #KSM, #KGRM

**5<sup>97</sup> YOUR CHOICE**

**BLACK LOG RACK W/CANVAS CARRIER** **15<sup>98</sup>**  
 Black log rack with removeable canvas carrier. Heavy duty black steel stand. Heavy duty removeable black canvas log tote. Easy to assemble-snaps together in seconds. #201168

**5-PC. POLISHED BRASS OR ANTIQUE BRASS FIRESET** **44<sup>94</sup>**  
 Large ball handles. Large Tampico hearth brush. 1 pc. poker. Reinforced shovel blade. Heavy duty log lifter. Lacquered finish prevent tarnishing. Easy to assemble. #234107/#204391

**40-INCH LOG HOOP** **24<sup>97</sup>**  
 Rugged tubular steel. Powder coated rust resistant finish. Holds up to 1/2" face cord. #721

**EXPANDABLE WOOD RACK** **29<sup>98</sup>**  
 Rugged tubular steel. Holds up to 3 face cords. 2x4's not included. #744  
**4' DELUXE WOOD RACK #754 39.94**  
**4' PATIO WOOD RACK #724 27.88**

**4-SQUARE BAR STEEL FIREGRATE** **6<sup>93</sup>**  
 Apartment size, sturdy 18" fireplace grate. Made of 5/8" steel. Built with 4-bars. #5818-54  
**5-BAR FIREGRATE #8823-5 9.93** **7-BAR FIREGRATE #8930-7 17.98**  
**6-BAR FIREGRATE #8827-6 10.93**



**24 PACK STARTERLOGG WOOD FIRESTARTER**

"The Original" wood firestarter. No kindling/ newspaper required. Value pak-stock up for the season. Safe, convenient. #12350

**5.99** You pay  
**-1.25** Mfrs. Mail-in Rebate  
**4.74** Your final cost

**NOW ONLY**

**5<sup>99</sup>**  
**WAS 6<sup>94</sup>**

**Hot deals on a variety of heaters!**



**DOUBLE SYSTEM SMOKE & FIRE DETECTOR** **23<sup>97</sup>**  
 Detects both fast and slow-burning fires. 5-Year limited warranty.  
**120V AC-DC SMOKE DETECTOR 18.88**

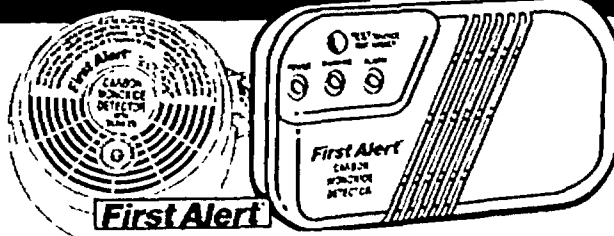

**BATTERY POWERED CARBON OR PLUG-IN CARBON MONOXIDE DETECTOR** **29<sup>97</sup>**  
 Your Choice  
 #PICO/NICO

**360° ELECTRIC HEATER/FAN** **44<sup>88</sup>**  
 Two heat settings-750 and 1500 watts. Extra long 8-foot cord. Tip over switch. Fan only switch. #CZ 2200

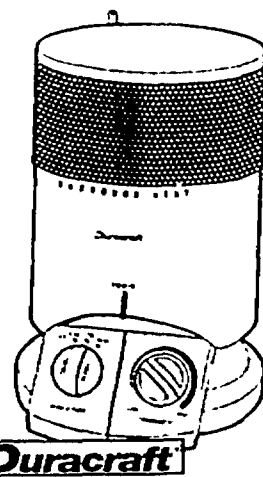

**OSCILLATING HEATER/FAN** **36<sup>94</sup>**  
 3-Heat settings 600/900/1500 and fan only. Built in twin circuit breaker. Child resistant switch. #CZ-2005

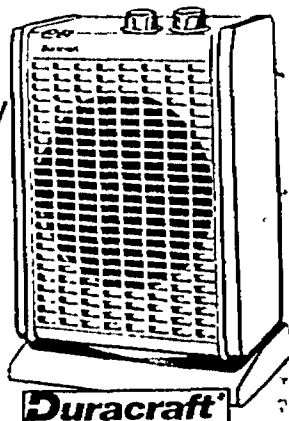

**5120BTU/1500WATT HEATER FAN** **\$39**  
 Child resistant safeguard switch prevents tampering. #CZ-2100

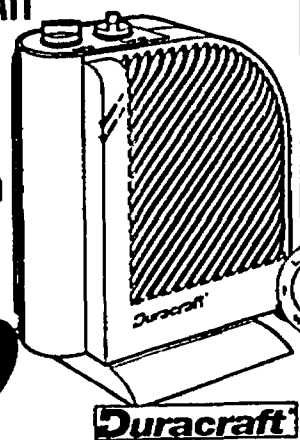

**600/900/1500 watts DeHEAT MACHINE** **\$99**  
 The ultimate in safety. Tip-over "OFF" switch no exposed sharp edges. Permanently sealed with pure diathermic oil.

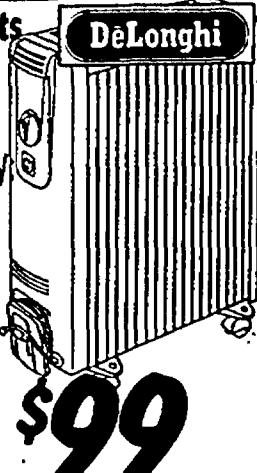

**TITAN UTILITY HEATER** **\$29**  
 Two heat settings 1500/1300 watts. Adjustable, automatic thermostat. Safety over load thermal protector. One year warranty. #MH-761

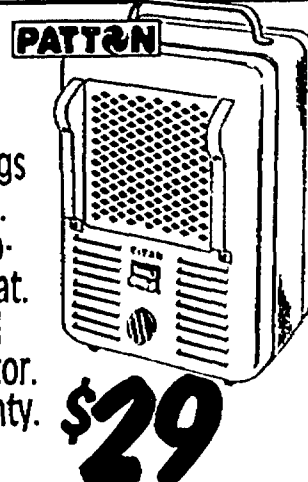

**TURBOTECH HEAT ACCELERATOR PORTABLE HEATER** **89<sup>88</sup>**  
 Two heat settings with indicator lights 750/1500 watts. Adjustable thermostat accurately maintains desired temperature. #T-150

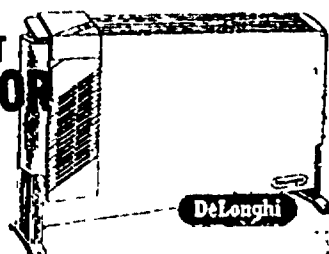

All seasonal items available while quantities last. Limited to stock on hand. Sorry, no rain checks.

**GIFT IDEA VALUES FROM THE SQUARE!**



# An Early Bird Holiday Gift *from the* Square! FRIDAY & SATURDAY 6 AM TO NOON ONLY!

**COUPON**

# \$5 OFF

PURCHASE OF  
\$50 TO \$99<sup>99</sup>

Must present coupon at checkout. Cannot be used on already reduced merchandise (sale & reduced items), lumber or discounted installation charges. Not valid with any other offer. Limit one per family.

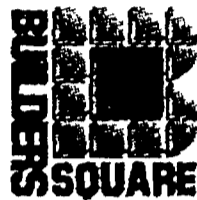

6 AM - NOON, FRI. & SAT. NOV. 29 & 30 ONLY!

**COUPON**

# \$10 OFF

PURCHASE OF  
\$100 TO \$199<sup>99</sup>

Must present coupon at checkout. Cannot be used on already reduced merchandise (sale & reduced items), lumber or discounted installation charges. Not valid with any other offer. Limit one per family.

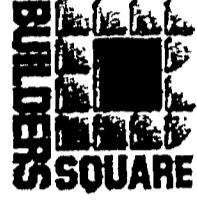

6 AM - NOON, FRI. & SAT. NOV. 29 & 30 ONLY!

**COUPON**

# \$25 OFF

PURCHASE OF  
\$200 TO \$299<sup>99</sup>

Must present coupon at checkout. Cannot be used on already reduced merchandise (sale & reduced items), lumber or discounted installation charges. Not valid with any other offer. Limit one per family.

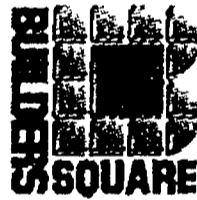

6 AM - NOON, FRI. & SAT. NOV. 29 & 30 ONLY!

**COUPON**

# \$50 OFF

PURCHASE OF  
\$300 OR MORE!

Must present coupon at checkout. Cannot be used on already reduced merchandise (sale & reduced items), lumber or discounted installation charges. Not valid with any other offer. Limit one per family.



6 AM - NOON, FRI. & SAT. NOV. 29 & 30 ONLY!

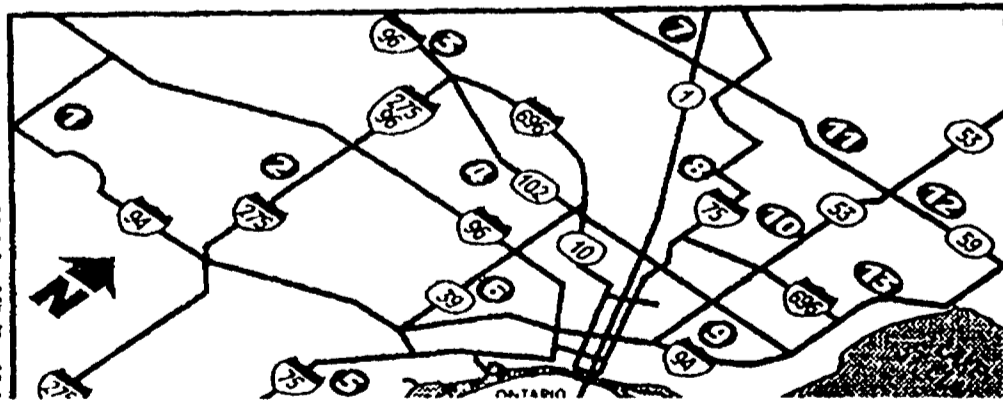

- 1 YPSILANTI 2820 WASHTENAW AVE...434-5210
- 2 CANTON 42000 FORD RD.....981-8400
- 3 NOVI 43610 WEST OAKS DR.....344-8855
- 4 LIVONIA 2965 7 MILE RD.....442-8580
- 5 SOUTHGATE 14800 DIX-TOLEDO RD..246-8500
- 6 DEARBORN 5951 MERCURY DR.....336-6900
- 7 WATERFORD 2214 SUMMIT MALL RD.681-4884
- 8 ROYAL OAK 4949 COOLIDGE H
- 9 DETROIT 8400 E. 8 MILE.....
- 10 STERLING HTS. 33801 VAN D
- 11 ROCHESTER HILLS 223 AUBI
- 12 UTICA 45160 UTICA PARK BLVD
- 13 ROSEVILLE 31510 GRATIOT AV
- 14 PORT HURON 4715 24TH AVE

REGULAR STORE HOURS: MONDAY - SATURDAY: 7:00 A.M. to 9:00 P.M. SUNDAY: 9:00 A.M. to 6:00 P.M.

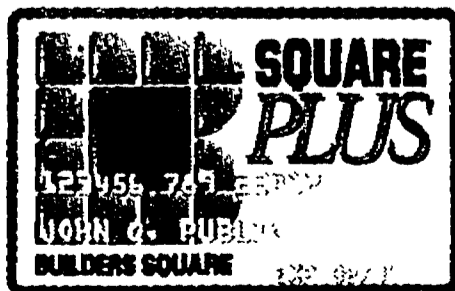
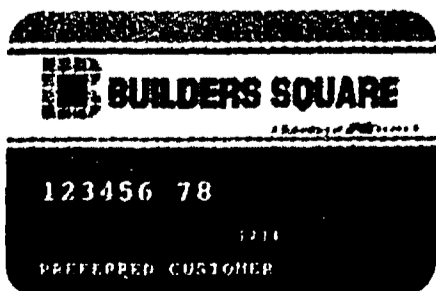

\* PRICE PROMISE DETAILS: We will match exact prices on identical merchandise from local competitors. Same manufacturer and model numbers. Limited to stock on hand. We reserve the right to limit quantities. Applies to non-member club prices and catalog prices including freight. Does not include clearance or going out of business sales.

\* CREDIT DETAILS: With approved credit. The number of months you will pay and the amount of your minimum monthly payments will depend on additional purchases and your balance. Payments fluctuate according to account balance.

©1996 BUILDERS SQUARE, INC. AD#4411

Limited quantities. Sorry, no rainchecks. At least one of each item available in store at the beginning of the sale. Not responsible for typographical errors.

## A Senior's Discount is now available every Tuesday! See store for more details.

# **MOLLY MAID Gives You Peace of Mind That's Priceless**

- Dependable, Consistent, and Thorough Cleaning by Uniformed Professionals.
- Your Maids are Properly Insured, Bonded and Supervised.
- 100% Written Guarantee of Satisfaction.



**Call TODAY For Your Free Estimate!**

# 305-7070

*Give Yourself or a Loved One The Precious Gift of Time*

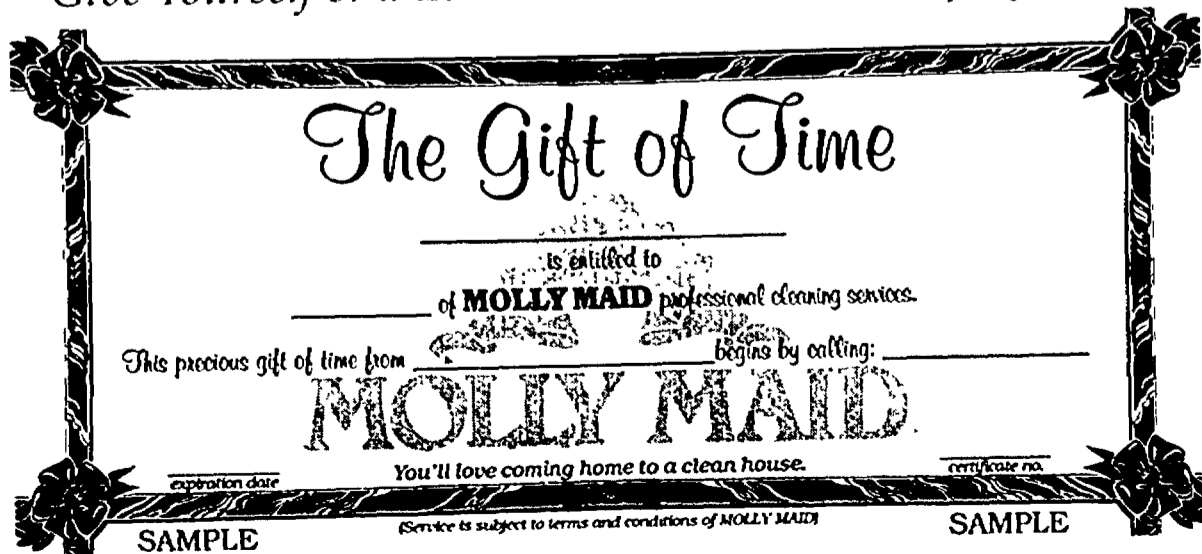

# ***Enjoy Your Precious Free Time***



## **You'll Love Coming Home to a Clean House**

  
**MOLLY MAID.**

*A Household Name Since 1979*