



# Yakima 'Rocks'

## Northville girl will dance with Radio City Rockettes

By Kim Kovel  
RECORD STAFF WRITER

Balancing school, ballet lessons and performing at Detroit's Fox Theater six nights a week is a demanding schedule.

Eleven-year-old Amy Yakima of Northville Township is doing just that, appearing for the second straight year in the Radio City Christmas Spectacular with the Rockettes.

"I sort of get used to it after a while," Yakima said. "Sometimes you have to get up a little bit earlier."

From now until Dec. 26, with the exception of Mondays and Christmas Day, Yakima will be on stage.

Alternating shows with 11-year old Emma Young of Novi, Yakima will be the featured "little girl" in half of the show's 52 performances.

She's Clara in "The Nutcracker: A Teddy Bear's Dream" and appears in other dance numbers. "I'm a ginger bread cookie," she added, laughing.

Mom Mary Beth said Amy,

### RADIO CITY ROCKETTES

- **What:** Tap-dancing Rockettes, live animals and a cast and crew of nearly 100 return to Detroit's Fox Theater for the Radio City Christmas Spectacular
- **When:** Nov. 26-Dec. 26 except Mondays and Dec. 25; various times
- **Where:** Fox Theater, 2211 Woodward Ave., Detroit
- **Tickets:** Cost \$20.50-\$65.50 with limited Elite and Gold Circle seating
- **Contact:** (313) 471-6611 or www.olympiaentertainment.com; (313) 471-3099 for group sales

who's been dancing since age 3, auditioned in Chicago in spring against about 100 other hopefuls.

Rehearsals started Nov. 5. Since then, Amy's had tutoring at the Fox every morning and constant practices.

"It's definitely intense," Mary Beth said. "She's actually a very self sufficient. She knows when she comes home she has to do her homework. She has a planner."

"She wants to do it. There's no one pushing her."

Amy attends Meads Mill Middle School. For early curtain calls, mom is on hand to help with her daughter's hair.

Her father, Dan, helps with



Submitted Photo

Northville resident Amy Yakima, 11, will return to the stage this holiday season, alongside the world-renowned Radio City Rockettes.

driving. The Yakimas' two other children, Emma, 8, and Lauren, 3, dance in Dearborn with their big sister.

Mary Beth said the first time she saw the Rockettes she brought along Amy, who was 3.

"That was the first time we ever saw the show. We loved it. I cried," Mary Beth said. "Who would have ever thought?"

Amy is again enjoying her time with dancers and stagehands alike.

"It's actually very nice just to meet a lot of people, and all the cast members are very nice," she said.

With a dressing room on the fifth floor, the sixth-grader also does plenty of moving offstage as she changes from one rhinestone costume to another.

She has a before-show tradition: "I always put glitter on," Amy said. "I have a glitter spray for my hair. It makes me sparkly."

Amy has her sites set on being a choreographer or director someday, and Mary Beth is supportive.

"It's been wonderful. If it's taught her how to (be) organized,

it's taught me how to be organized," she said. Will the family be ready for the holidays?

"You have to start shopping early," Mary Beth said. "It's crazy."

Kim Kovel can be reached at (248) 349-1700, ext. 107, or via e-mail kkovelle@ht.homecomm.net.

## CHRISTMAS TIPS

Looking for holiday activities for your children?

Why not give them a "to do" list of their own? Here are 10 suggestions:

1. Write your Christmas wish list for Santa and mail it
2. Make two ornaments: one for your tree and one for a friend
3. Decorate your Christmas tree
4. Visit www.claus.com
5. Bake cookies for Santa, friends and neighbors
6. Do a good deed for someone in need
7. Donate some of your toys
8. Attend a Christmas play or concert
9. Make presents or cards for your parents, sisters and brothers
10. Wrap presents and put under the tree

Source: Santa Beacons (www.santa Beacons.com)

## REMEMBER, ONLY YOU CAN PREVENT FOREST FIRES

A Public Service of the USDA Forest Service and Your State Forester.



## Cost-Effective Statewide Coverage

**MIA/NPA**  
Michigan Press Association  
Michigan Newspapers, Inc.  
827 N. Washtenaw Ave.  
Lansing, MI 48206  
Phone: 517-377-1122  
Fax: 517-377-1229  
www.michiganpress.com  
wendy@miapress.com

Place your 2x2 display ad and reach over 3.5 million readers for just \$949! Place a 25 word classified and reach over 4 million readers for just \$299! Contact this Newspaper or Wendy and Christine at Michigan Newspapers Inc.

### GIVE A GIFT THAT MAKES A LASTING IMPRESSION!

- Two hour interior design consultation \$150
- The person of your choice will receive a special gift certificate
- Certificate good for choice of: color selection for rooms, design ideas, or furniture rearrangement
- Call for more details

**BDG ARTS LLC** DESIGN CONSULTANTS  
BRADLEY D. GRAVELLE 734 546 6606  
JANEY MUSE 734 732 1594

**Christmas in the Country**  
14<sup>th</sup> Annual  
**Arts & Craft Show**  
Sponsored By South Lyon Football Boosters  
**Saturday, December 4**  
**10:00 am - 4:00 pm**  
Admission \$2 • Over 150 Booths  
**South Lyon High School**  
Eleven Mile & Pontiac Trail

Announcing the opening of:  
**ASSOCIATES IN PODIATRY OF MICHIGAN**  
Specializing in the Care of the Foot and Ankle  
Dr. Tammy Gephart, D.P.M.

Foot and ankle problems can literally alter, or even ruin, a person's lifestyle.

Dr. Tammy Gephart is a specialist in the prevention, care and cure of foot and ankle problems, offering both conservative and surgical procedures for treatment.

As a podiatric surgeon, Dr. Gephart also has a strong interest in sports injuries and works in general podiatry, pediatrics, orthotics and diabetic limb salvage.

**Credentials:**

- Graduate of Ohio College of Podiatric Medicine
- Surgical Residency: Northport VA Medical Center
- Member American College of Foot and Ankle Surgeons
- Studied with Dr. John Burzotta, Foot and Ankle Specialist for the New York Jets
- Member American Podiatric Medical Association
- Member Michigan Podiatric Medical Association
- Member The American Diabetes Association
- HIPPA Compliant

For a confidential consultation, call:  
Dr. Tammy Gephart, D.P.M.

**ASSOCIATES IN PODIATRY OF MICHIGAN**  
734-414-0874  
990 W. Ann Arbor Trail, Suite 200  
Plymouth, MI 48170  
www.tammygephartpm.com

**Suffering from foot or ankle problems today!**  
Dr. Gephart, D.P.M.  
Sports or Recreational Injuries

**Hammer Toes**  
**Flat Feet**  
**Ingrown Toenails and Other Nail Conditions**  
**Arch Pain**  
**Achilles Tendonitis**  
**Heel Pain**  
**Bursitis**  
**Arthritis**  
**Diabetes and Related Limb Affects**  
**Neuropathy**

**FLAGSTAR BANK**

**"FANTASY GIFT CD" CERTIFICATE OF DEPOSIT**

Take the interest.  Take the gift.  Take both.

**ELDER FORD**

Open a Flagstar Fantasy Gift CD and enjoy the benefits of your investment today.

**Fantasy CD Gifts\***

- Microsoft Xbox\*
- Sony Playstation\*2
- Oreck XL\* Air Purifier
- Apple iPod 40GB Photo
- Bose\* Wave\* Music System
- Sony Cyber-shot\* Pro Digital Camera
- Sony DVD Handycam\* Camcorder
- MICROMV™ Handycam\* Camcorder
- Sony 23" LCD WEGA™ Flat Panel TV
- Sharper Image Leather Massage\* Chair
- Sony 34" LCD WEGA™ Flat Panel TV
- Ultimate Golf Makeover Package
- Ultimate Somerset Collection Shopping Spree
- Viking\* 53" Outdoor Gas Grill
- Polaris Trail Sport Super Sport Snowmobile
- Sony 42" Plasma WEGA™ TV

**Major Gifts**

- 2005 Ford Mustang V6 Coupe Premium
- Motor City Harley-Davidson Sportster\* 883 C
- Motor City Harley-Davidson Ultra Classic\* Electra Glide\*
- Golf Trip Packages to the 4 major tournaments

MEMBER FDIC  
www.flagstar.com

For a banking center near you, call (800) 642-0039

**FLAGSTAR BANK**

\*Offer expires February 1, 2005. Gifts are limited to Fantasy CD certificates of deposit. Fantasy gifts are subject to availability. Minimum deposit requirements start at \$1,000. Choice of gifts and Annual Percentage Yield will vary depending on the deposit level and length of the CD term. See a Flagstar representative for full program details and disclosures.





Photo Courtesy of PETA

Jason Baker has protested against Kentucky Fried Chicken before, such as this episode earlier this year in Hong Kong, China.

### FOWL: Northville resident's protest nets jail time

continued from page 1A

Chicken restaurant. PETA officials contend the corporation mistreats chickens for consumer consumption.

"I couldn't sleep the night before," he said. "But when I found a KFC there it just kind of put a pit in my stomach. I knew I had to do something."

However, according to Vietnamese law, public demonstrations are illegal unless pre-approved by the government. Baker admitted he had not attempted to gain government approval.

According to Bruce Friedrich, the Director of Vegan Campaigns for PETA, protesting on vacation is fairly common.

"A lot of PETA members demonstrate while on vacation," Friedrich said. "I've done it myself. You make a poster, which is easy to do, and you pass out leaflets."

Baker, who has been arrested for demonstrations several times during his 10 years with PETA,

said he has been protesting against Kentucky Fried Chicken throughout Asia for the past two years. PETA's official protests of the company began in January 2003, Friedrich said.

PETA alleges Kentucky Fried Chicken is responsible for animal abuse and "torture" at farms supplying the U.S.-based firm with chickens.

"It's an outrage," said Friedrich. "We've actually had more than 5,000 demonstrations worldwide against KFC."

Kentucky Fried Chicken officials denounced the protest in a prepared statement.

"PETA has disparaged our brand and misrepresented the truth about our responsible industry-leading animal welfare standards," spokesperson Bonnie Warschauer said.

"KFC is committed to the humane treatment of chickens. We don't own any poultry facilities and our suppliers are acting responsibly. We believe enough is enough. We want PETA to know that their corporate terror-

ist activities won't be tolerated." Baker said he cannot tolerate Kentucky Fried Chicken.

"I'll demonstrate again," he said. "If what happens to me gets word to KFC and forces them to make changes it will be worth it."

Still, Baker said he was extremely nervous about being arrested in a communist country, especially after hearing several stories about possible Vietnamese punishments.

"But you never know which ones are the truth and which ones are the urban legends," he said.

"I'm definitely nervous and definitely concerned," Baker said prior to being fined. "But no matter if the Vietnamese throw the book at me, which they might, and I go to jail, it won't be as bad as what KFC does to the chickens. I'll eventually get out. The chickens won't."

Sam Eggleston can be reached at (248) 349-1700, ext. 104 or at [seggleston@ht.homecomm.net](mailto:seggleston@ht.homecomm.net).

### OUTAGE: Northville left without morning power

continued from page 1A

Stuck in a power outage, city officials said they should be any further problems. "We'll do the permanent repairs on the... cable and then move people back to the cable that they are typically served by."

Singer said the outage struck at about 6:30 a.m., and nearly five hours and left random portions of Northville scrambling for electrical juice.

"At this point, we don't know what the cause of the problem was," he said. "We can be pretty sure it's not weather-related. The Northville problem is one of a handful of scattered problems that DTE has faced — nothing that is really untypical."

He said he wasn't sure when Northville repairs will be complete. In the meantime, he said electrical rerouting will ensure customers have power.

In the middle of downtown, storefronts remained dark early Wednesday morning as motorists honked, waved — and in some cases, gestured — their way through makeshift intersections. From Coney Islands to cleaners, makeshift Northville remained still.

At either end of town, however, power remained on — at least for some.

At city hall, electricity allowed municipal offices and the fire department to remain fully functional. Even city employees, Wendy Gutowski arrived work despite being blacked-out at home.

Gutowski said power at her Northville Estates home cut out at about 6:30 a.m., just in time for her husband to open and close the couple's electrically-operated garage door. Because her car was parked outside for the night, though, she kiddingly said she had no plausible excuse for missing work.

"That was unfortunate for me, because I ended up having to come to work," Gutowski said.

At the eastern end of town, Starbucks Coffee customers were lined up outside the door. Power remained on, much to the relief of those who sought a caffeine jump start to their work day.

"It's not a real disaster until I have to go without my morning coffee," Northville Township resident Rebecca Stallworth said.

Record staff writer Kim Kovale contributed to this story.

THINKING ABOUT A NEW FURNACE? **LENOX** FREE ESTIMATES (734) 525-1930 Our 30th Year! UNITED TEMPERATURE 8919 MIDDLEBELT • LIVONIA

Urgent news for people who took **VIOXX** Many VIOXX users suffered strokes, heart attacks, heart failure, chest pains, blood clots, serious bleeding and even death. If you or a loved one took VIOXX, and had any of these problems, call us now toll free at 1-800-THE-EAGLE for a free consultation. We practice law only in Arizona, but associate with lawyers throughout the U.S. **GOLDBERG & OSBORNE** 1-800-THE-EAGLE (1-800-843-3245) www.1800theeagle.com

**COMMERCIAL RESIDENTIAL**  
**Carpet's Etcetera**  
Top Name Brand Flooring for all your needs - Specializing in Residential Customers  
CARPET • WOOL & SISAL • TILE • WOODS • VINYL • LAMINATE  
Custom Area Rugs Made To Your Specification!  
**FREE PADDING** With carpet purchase and installation. Offer expires Nov. 31, 2004.  
Bruce • Mannington • Mohawk • Shaw • Pergo • Wilsonart • Daltile • Portobello • Amtico • Aladdin • American Berber • CustomWeave • Fabrica • Kid Proof • Laura Ashley • Masland • Stanton • DesignWeave • Fibreworks • Kane • Armstrong  
And Many More!  
Call for the Location nearest you! **248-640-2373**  
www.carpetsetcetera.net

# BONELESS SKINLESS CHICKEN BREAST

**\$1.67** per pound

**\$3.99 lb.** USDA Choice Whole Boneless New York Strip

**\$1.97 lb.** Midwest Best Whole Boneless Center Cut Pork Loin

**\$1.19 lb.** Midwest Best Whole Boston Butt Pork Blade Roast

**2 for \$4** Farmland Sliced Bacon Regular or Thick, 16 oz. pkg.

Buy One Get One **FREE** Kellogg's Frosted Flakes 25 oz. Corn Pops, 18.8 oz.; Crispix, 12 oz.; Rice Krispies, 19 oz.; Froot Loops, 19.7 oz.; Frosted Bite-Size Mini Wheats, 24.3 oz.; or Variety Pack, 9.6 oz.

Buy One Get One **FREE** Indian Summer Apple Juice 64 oz.

Buy One Get One **FREE** Campbell's Select Soups all varieties 18.6-19 oz.

SHOP ONLINE AT **WWW.BUSCHS.COM**  
Farmington Hills & Plymouth/Northville locations • pick-up only

Discover the Chef in you!  
**Decadent Desserts: Meal Solutions Cooking Class**  
TONIGHT, December 2<sup>nd</sup> from 6:00 p.m. to 7:30 p.m. at our Livonia store (Six Mile Road at Newburgh Road)

**BUSCH'S**  
Fresh. Food. Ideas.

Prices effective 12/23/04

# Holidays bring identity theft concerns

## Experts say nothing beats awareness and vigilance

By Kim Kovel  
RECORD STAFF WRITER

Although he retired and moved to Florida in April, David Berkaw has kept in regular contact with Northville Township — at least the detective bureau.

That's because a year ago he became a credit card fraud victim, realizing it only after he tried to use his credit card at the gas pump.

"My credit was denied," Berkaw said. "I found out that accounts had been opened at banks I had never heard of."

Identity theft happens quickly, experts contend. And with last week's holiday shopping kick-off and renewed traveling season, credit card users are once again being reminded to take charge of their credit fate.

Township Det. Bill Helke said watching the mailbox is one way to protect personal information.

"Mail theft is a major problem," Helke said. "Your outgoing bill, you leave it in the mailbox in front of your house and put the 'come steal me sign' up — flag."

Accounts and routing numbers are right on the checks, Helke said. "I could print up checks... and start passing checks. Most people could make a reasonable forgery of your signature."

# Managing the Holidays

Outgoing mail should be placed in U.S. Postal Service drop boxes, he said; when vacationing, have it held.

Republic Bank Security Officer Doug Rosier said a popular scam is "phishing," a tactic using e-mails urgently requesting personal information.

"It's fishing for information," Rosier said. "You get an unsolicited e-mail from your bank, your credit card company or even the FDIC that's telling you that your institution is under investigation."

"No one is going to send you an e-mail like that. We already know who you are."

He recommended dealing with reputable stores: those you can drive to and have signs on brick buildings.

Helke said the same applies to attempts to get information over the phone.

"Don't give out this informa-

tion," he said. "Call the 800 (fraud investigation) number on the credit card. People should keep record of those kind of things in case a credit card's stolen."

### Pay attention, or pay dearly

When shopping, whether at home or abroad, keep a watchful eye, Helke said.

"Occasionally people don't pay attention and the clerk may palm the credit card," Helke said. "You get a lot of temporary help this time of year. They're not all honest."

"Make sure you're focused on your transaction."

Another ploy is false readers or "skimmers," devices that look like legitimate credit or debit card scanners.

"(They're) not hooked up to the proper credit system," Rosier said. Instead, they store thousands of account numbers ready to exploit.

Once tossed, pre-approved credit card applications are problematic due to information in bar codes. Rosier recommends destroying those.

Besides scanning monthly credit card statements, the Fair and Accurate Credit Transactions Act of 2003 is key, allowing consumers one free credit report per year.

Get it, look at it, and make noth-

### PREVENTATIVE MEDICINE: CREDIT CHECKLIST

To avoid identity theft, keep the following useful tips in mind:

- Put outgoing mail in U.S. Postal Service collection boxes; don't "flag" it in your mailbox
- Don't leave mail in your mailbox overnight or on weekends; put holds on mail when away
- Don't give out personal information to unsolicited calls and e-mails
- Deal with "brick-and-mortar" stores if possible
- Shred bar codes and personal information on unwanted documents (credit card applications)
- Sign new credit cards. Don't ever leave receipts behind
- Memorize Social Security numbers and passwords
- Review monthly statements and annual consumer credit reports

Sources: Northville Township Detective Bureau, Republic Bank, U.S. Postal Inspection Service

**Contact the bureaus**  
There are three credit bureaus from which to order a report or report fraud. Here's the list:

- Equifax, [www.equifax.com](http://www.equifax.com)  
Order a report: (800) 685-1111  
Report fraud: (800) 525-6285
- Experian, [www.experian.com](http://www.experian.com)  
Order a report: (888) 397-3742  
Report fraud: (888) 397-3742
- Trans Union, [www.transunion.com](http://www.transunion.com)  
Order a report: (800) 888-4213  
Report fraud: (800) 680-7289

**Other helpful numbers:**

- U.S. Postal Inspection Service, Detroit Division: (313) 226-8184
- Michigan Attorney General Fraud Hotline: (800) 24-ABUSE
- Federal Trade Commission Identity Theft Hotline: (877) ID-THEFT
- Social Security Administration Fraud Hotline: (800) 269-0271

ing's out of place, Rosier said. And review credit card accounts online, rather than waiting for monthly billing statements.

Berkaw, who's still clearing records after thousands were spent in his name, says the same. "One has to keep on it!" he said.

"You have to take care of it yourself because nobody's going to take care of it for you. You have to prove that you didn't do this."

## Save money with our multi-policy discount!

When you insure your car and home or mobile home with us, through Auto-Owners Insurance Company, we'll save you money with their multi-policy discount! Mature policyholders can earn even greater savings. Contact our agency today!



**Auto-Owners Insurance**  
Life Home Car Business  
The No Problem People™

**C. HAROLD BLOOM INSURANCE**  
108 W. Main, Northville  
349-1252



## An everyday great rate.

# 2.10% APY\*

for balances of \$25,000 to \$49,999.99

### New Key Premier Money Market Savings

- Easy access to your funds
- Available for personal and small business accounts
- Automatically eligible for our best full-featured checking package

Open a Key Premier Money Market Savings Account today.

Stop by any KeyCenter, call 1-888-KEY-1234, or visit Key.com

**KeyBank** | Achieve anything.

\*All annual percentage yields (APY) are accurate as of 11/14/04 and are subject to change without notice. All interest rates and APYs for all balance tiers are variable and may change at any time after the account is opened. APYs for Personal accounts are as follows: \$01-\$2,499.99, APY is 0.10%; \$2,500.00-\$9,999.99, APY is 0.10%; \$10,000.00-\$24,999.99, APY is 0.10%; \$25,000.00-\$49,999.99, APY is 2.10%; \$50,000.00-\$99,999.99, APY is 2.20%; \$100,000.00+, APY is 2.30%. APYs for Small Business accounts are as follows: \$01-\$24,999.99, APY is 0.10%; \$25,000.00-\$49,999.99, APY is 2.10%; \$50,000.00-\$99,999.99, APY is 2.20%; \$100,000.00-\$249,999.99, APY is 2.30%; \$250,000.00-\$499,999.99, APY is 2.30%; \$500,000.00-\$999,999.99, APY is 2.30%; \$1,000,000.00+, APY is 2.30%. Requires minimum opening deposit of \$25,000.00 from funds not currently on deposit with KeyBank. Fees may reduce the earnings on this account. Balances are FDIC insured up to the maximum allowable limit. Public funds are not eligible for this offer. Key.com is a federally registered service mark of KeyCorp. ©2004 KeyBank. Member FDIC.



## CUSTOM Gift Cards Available



# NOVI

248-477-2266

AGOSTA.COM

# GINA AGOSTA

HAIRCOLOR • DESIGN & SPA



# SHOPPING: downtown merchants mix customer service with high-tech convenience

continued from page 1A

## Something for everyone

And for the person impossible-to-buy-for on your list, let them decide, said Janet Bloom, Northville Chamber of Commerce marketing and events director. More than 75 businesses in town accept "certificates" available for purchase from the Chamber site at [www.northville.org](http://www.northville.org) or 195 S. Main St. office.

"They're great for a teacher, client or vendor," she said. The gift certificates have caught on for several Northville specialty retailers, apparel stores and restaurants, Bloom said.

"There's a cross-section of tastes," she said. A dozen different restaurants — from Bonfire Bistro to Emily's to Little Italy to Rocky's — accept them.

The Chamber and Central Business Association this year are wooing customers to city sidewalks through a series of promotional events like the recent holiday lighted parade and the Candlelight Walk Dec. 10. Individual retailers meanwhile are actively promoting in-store events.

Their goal: bring shoppers from the surrounding communities to the town they may not have seen lately. City leaders lent their support with recent revisions to the downtown parking management system to move employees farther out so shoppers can park closer in.

Stores like Orin Jewelers and Stampedder Plus took the curbside convenience a step further, implementing valet parking service last weekend. Margene Buckhave, specialty scrapbook store owner, said she does not plan to continue the service because shoppers did not use it.



Customers at Orin Jewelers in downtown Northville are pampered during special events with valet parking.

But Orin's David Beyer said he will offer the parking service for events he scheduled to follow the jeweler's annual open house Sunday. Orin guests for Ladies' Night Out Dec. 7 and Men's Night Out Dec. 14 can sample jewelry, enter a prize drawing and share snacks with friends.

### For your convenience

Orin Jewelers and Kitchen Witch are among the many merchants who extend their hours for short-on-time holiday shoppers.

Ronnie Cambra's housewares and kitchen specialty shop starting yesterday extended until 8 p.m. hours Mondays through Fridays. Saturday hours are 10 a.m.-6 p.m.;

Sundays, noon-5 p.m.

Merchants regularly meet to collectively plan and share ideas how to draw folks who reside on the surrounding streets and in the nearby subdivisions to turn toward their downtown instead of the malls. Their faces behind local registers have opened shop within the last month and anchored the downtown for generations.

Saavy local retailers have responded to the marketplace increasingly competitive around them, Bloom said. Shoppers who want to support local businesses now can find dozens of downtown businesses on the Internet, she said.

From his Main Street base, Cole said he is courting customers local-

ly and in other states. Since he launched his Web site [www.greatharvestnorthville.com](http://www.greatharvestnorthville.com) in September, he has watched on-line sales continue to increase.

"We do a lot of business off it," Cole said. "For us, it's been very useful."

His products — affordable and transportable — are a great fit for on-line ordering, Cole said. His shelves are stocked with baskets and boxes for his stream of requests to "ship it."

Maureen Johnston may be reached at (248) 349-1700, ext. 103, or [mjohnston@ht.homecomm.net](mailto:mjohnston@ht.homecomm.net).

# What's happening in downtown Northville?

All Aglow ceremony slated for Dec. 10

Tomorrow is the deadline to purchase a tree light in time for the Dec. 10 All Aglow illumination ceremony.

The annual event is 6:15 p.m., Friday, at the downtown gazebo. Volunteers will serve hot chocolate and cookies.

The Mothers' Club of Northville has been hosting the annual illumination event to raise funds for local school children for more than 50 years. Through the end of the year, donors can purchase tree lights in honor or memory of a family member, friend, teacher or significant acquaintance.

Supporters who purchase their lights by Dec. 3 earn a spot for their honoree on the Mothers' Club board near the gazebo downtown as well as in a Northville Record advertisement.

Donation categories are Diamond \$100; Ruby \$50; Emerald \$25; Sapphire \$10 and Pearl \$5. For more information, call (248) 347-1954. The Mothers' Club is a non-profit organization that has supported Northville school children since 1935. The group raises about \$35,000 annually.

Candlelight Walk next weekend

Northville merchants will light a path to their storefronts during the annual Candlelight Walk Dec. 10.

Businesses owners and clubs are hosting

a series of activities Friday night to bring the community downtown to shop and share the holiday season.

• 6:15 p.m. — Mothers' Club All Aglow Illumination for Education

• 7:30 p.m. — Old-fashioned Christmas caroling

• Until 11 p.m. — Stores open for late night shopping.

The sidewalks will glow with the light of hundreds of tiny candles, said Toni Genitti, Northville Central Business Association co-president. Special treats will be scattered throughout town to keep growling stomachs at bay.

For more information, call the Northville Chamber of Commerce (248) 349-7640 or visit [www.northville.org](http://www.northville.org).

### Santa Hours

Santa will be at his house located in the middle of downtown, near the Main Street gazebo, through Dec. 19. Fridays 6-9 p.m. Saturdays and Sundays Noon-3 p.m.

# Mothers' Club members will host annual open house



Submitted Photo

Beth Peterson donated time recently to help decorate trees at the Northville Senior Center, located downtown.

By Maureen Johnston  
RECORD STAFF WRITER

Trees shimmering with ribbon and lights, piped-in carols and linen-clothed tables full of homemade hors d'oeuvres will open the holiday season for Mothers' Club of Northville life members Saturday.

The emeritus education supporters will gather 5-7 p.m., Dec. 4, at the newly renovated Northville Community Senior Center, 303 W. Main St. Luminaries will light the paths from the Cady Street parking lot and Main Street main entrance.

The annual open house for decades was held in individual homes. This year, they will mingle under one roof for the first time. Approximately 300 members and their invited guests are expected to attend.

"It will be a good for people who have been

at a different home in the past to all be together and see each other," said Bonnie St. Thomas, event chairperson this year and last.

The event is the club's sole fundraiser with proceeds to go toward four \$1,000 scholarships to Northville High School seniors in June. Members are eligible after belonging to the Mothers' Club 10-plus years.

St. Thomas said pulling together arrangements for the single location required a whole new plan. Club members, local residents and merchants cooperated to set the scene at the senior center, she said.

Preferences, Genitti's and Emerald City Design contributed ornaments, decorations and linens for the event. Beth Peterson, Barb Anderson and Carol Koster helped string the lights, trim the trees and place the poinsettias. After the event, decorations will remain for community enjoyment, St. Thomas said.

The event is a traditional holiday kick-off for couples, said St. Thomas, who plans to proceed with a dozen couples to dinner after the punch and hors d'oeuvres reception.

The hostesses are maintaining the tradition of preparing all the light menu offerings in their own kitchens. The 30 Mothers' Club life members operate independent of the Mothers' Club. Both are dedicated to supporting children in the community; members 10 years or less host events on a regular basis throughout the year, raising approximately \$35,000 annually to support Northville students.

To be added to next year's open house invitation list, call Marge Longridge at (248) 349-0551.

Maureen Johnston can be reached at (248) 349-1700, ext. 103, or [mjohnston@ht.homecomm.net](mailto:mjohnston@ht.homecomm.net).

# Tanger Outlets

POLO RALPH LAUREN FACTORY STORE • EDDIE BAUER OUTLET • GAP OUTLET  
FACTORY BRAND SHOES • OLD NAVY OUTLET • NIKE • RUE 21 • CARTER'S  
BASS • BANANA REPUBLIC FACTORY STORE • AEROPOSTALE • AND MANY MORE!

TANGER DAYS AT DICK SCOTT  
MOTOR MALL IN FOWLerville

# WIN

a lease for two years!



## 2005 Jeep Liberty Sport

Register at Tanger Outlet Center and Dick Scott Motor Mall now through December 8, 2004 and you could win a **FREE TWO-YEAR LEASE** for a 2005 Jeep Liberty Sport from Dick Scott Motor Mall in Fowlerville



Purchase a Dodge, Chrysler or Jeep & Get a \$100 Tanger Gift Certificate  
NOVEMBER 26<sup>TH</sup> - DECEMBER 8<sup>TH</sup>

The first twenty-five customers to purchase a vehicle at Dick Scott Motor Mall in Fowlerville will receive a \$100 Tanger Gift Certificate.

Howell, MI I-96 at M-59, Exit 133 • 517.545.0500 • [www.tangeroutlet.com](http://www.tangeroutlet.com)

THE NORTHVILLE RECORD  
Published Each Thursday  
By The Northville Record  
104 W. Main Street  
Northville, Michigan 48167  
Periodical  
At Northville, Michigan

Subscription Rates:  
Inside Counties \$26 one year home delivery, \$35 one year mail delivery.  
Outside Counties (in Michigan) are \$40 per year, prepaid. Out of state,  
\$50 per year.

HomeTown Newspapers™  
A Subsidiary of HomeTown Communications Network, Postmaster,  
send address changes to: The Northville Record, Post Office Box 470,  
Howell, MI 48844. POLICY STATEMENT. All advertising published in  
HomeTown Newspapers™ is subject to the conditions stated in the applicable  
rate card, copies of which are available from the advertising department,  
The Northville Record, 104 W. Main Street, Northville, Michigan 48167. (248-  
349-1700). HomeTown Newspapers™ reserves the right not to accept an  
advertiser's order. HomeTown Newspapers™ and its publishers have no authority to  
bind this newspaper and only publication of an advertisement shall constitute  
final acceptance of the advertiser's order. Postmaster, send address  
changes to: The Northville Record, Post Office Box 470, Howell, MI 48844.

Publication Number USPS 3989-20

## DIVORCE????

The failure either act first or respond quickly to divorce proceedings can affect the outcome of child custody, support and property division.

**TAKE ACTION IMMEDIATELY**

**248-982-7038**

**FAST, EFFECTIVE ASSISTANCE**

ARBOR HOSPICE & HOME CARE CELEBRATING 20 YEARS OF CARING

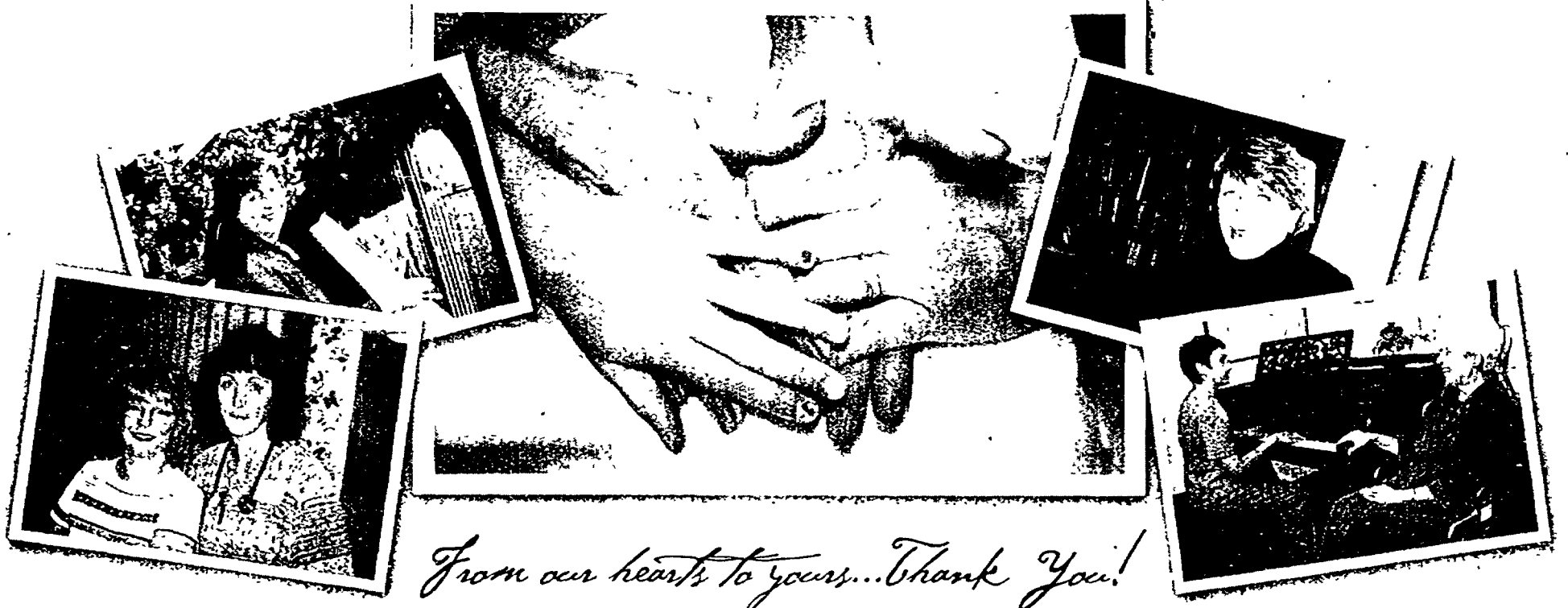

*From our hearts to yours... Thank You!*

"To the world  
you might be one person, but to one person  
you might be the world."

*Unknown*

*In honor of 20 years service to the community,  
Arbor Hospice & Home Care pays tribute to the hospice caregivers,  
staff and volunteers who define our mission each day.*

There are many opportunities to make a difference. To find out how you can help, contact one of our Development representatives today at 888-992-CARE (2273) or visit us on-line at [www.arborhospice.org](http://www.arborhospice.org)



2 4 8 • 3 4 8 • 4 9 8 0 • [www.arborhospice.org](http://www.arborhospice.org)

*"Without a sense of caring, there can be no sense of community." - Anthony J. D'Angelo*



**Brave Heart**  
healing hearts...strengthening memories.



We are grateful to the following community partners for their tremendous generosity in making our Open House a success:

**Bob Beson and Beth VanLoozen-Beson  
The Beson Family Foundation**

**Raffle Prize Donors:**

- Alfred's Jewelry
- Changing Seasons of Northville
- Cobbler's Corner • Dancing Eye Gallery
- Deadwood Bar & Grill • Emily's Restaurant
- Fine Threads • Gardenviews
- Healthy Solutions • Kitchen Witch • LaCorsetiere
- Marquis Theatre • Northville Candles & Gifts
- Orin Jewelers • Pendleton Shop
- RKA Petroleum Companies • Salutations
- Serenity Day Spa • Stampeddler Plus

**In-Kind Donors:**

Greenman's Printing & Imaging

**Refreshment Donors:**

Busch's Valu Land • Genitti's Hole-in-the-Wall  
Helen's Uptown Cafe • MacKinnon's

...and Special Thanks to:

Kay Brown, Harpist  
and the valued members of  
our Northville Advisory Committee



Brave Heart serves the counties of Wayne, Washtenaw, Oakland, Monroe, Livingston, Lenox and Ingham Counties. It was born as funded through a generous gift from The Beson Family Foundation and The Arbor Hospice Foundation.

**THANK YOU**

*In a full heart there is room for everything.*  
A. Porchia



*Each year, over 30 Arbor Hospice volunteers design and handcraft thousands of heart-shaped ornaments as part of our Hearts of Remembrance program. By purchasing a keepsake ornament, you can honor those who have touched your life while helping Arbor Hospice to continue our care throughout the community. How much does one heart cost? The amount is up to you. Whether \$20 or \$500, your gift will make a difference in the lives of those we care for each day.*

Call 888-992-CARE (2273), ext. 152 or visit us on line at [www.arborhospice.org](http://www.arborhospice.org) to order yours today!





## Balancing act!

Photo by JOHN HEIDER/  
Northville Record

**Performer-magician Timothy Wenk used a variety of techniques last Thursday during his visit to Silver Springs Elementary to bring home the importance of recycling to his young audience. With an expanding paper tree, Wenk demonstrated how recycled or reused newspaper can go a long way to saving trees.**

## CONTRACT: teachers, district sign two-year pact

continued from page 1A

previously negotiated step increases.

"They'll get a payment in January," Rezmierski said of this semester's retroactive increase.

Health care prescription drug co-pays now will be \$10 for generic brands and \$20 for name brands. Past co-pays were \$5 and \$10.

Rezmierski said he believes negotiations in this area will be ongoing because "health-care costs increase anywhere from 12-16 percent per year."

Student instructional days were lengthened to ensure a minimum of 1,098 hours over 182 days. Elementary schools will get four extra minutes per day; middle schools three; and one in high school.

Teachers must also perform an equivalent of five days' professional development work.

"Finally, next September, teachers and students alike will start school one day earlier: Aug. 24, instead of Aug. 25. This reportedly addressed the state's decision to move MEAP tests from the spring to early October, beginning 2005.

### Total impact

Rezmierski said the agreement impacts a variety of professional categories including teachers, psychologists, social workers and speech and language instructors. This school year, 23 new teachers were hired, and another 7-10 were hired due to staff retirements.

The contract does not include principals, secretaries, teaching assistants or bus drivers.

Five members of the union board provided a simple majority approval before the package came before the board, Rezmierski said.

### CONTRACT DETAILS

Based on a Nov. 23 contract, Northville's 450 teachers will get the following:

- 1-percent salary raise for first semester of 2004-05 (retroactive)
- 1-percent salary raise for second semester of 2004-05
- 2-percent salary raise for 2005-06 school year
- Doubled prescription drug co-pay (\$10 generic, \$20 name brand)
- Longer days (extra four minutes for elementary, three minutes for middle school, one minute for high school)
- School year for 2005-06 starts sooner (Aug. 24)

Union officials, including Northville Education Association President Ann Cook, did not return Northville Record phone calls prior to press time.

This is the third year the district hasn't received revenue increases, Rezmierski said. Recent negotiations were extended three times. Teachers are coming off a five-year contract, including a three-year contract and two-year extension.

"I think it's what most districts are settling for throughout the state," Rezmierski said. "Our financial plight... doesn't look very promising at all next year. Obviously we would love to have 10 years, but that never would have happened."

Kim Kovel can be reached at (248) 349-1700, ext. 107, or via e-mail at [kkovelle@ht.homecomm.net](mailto:kkovelle@ht.homecomm.net).

### Casimir Huyck

Howe Military School, a private co-educational school, grades 5-12, located in northeastern Indiana, has announced their Headmaster's List for the second six week grading period of the 2004-05 school year.

Cadet Casimir Huyck, a 12th grader at Howe and the son of Kathy and Edward Huyck of Northville, Mich., received this special award by attaining at least a 3.0, B average in his studies in a college prep curriculum.

Cadet Huyck has been attending Howe Military School since August 2001.

### Spelling Bee winners

For the second year in a row, Community Financial employees won the championship trophy from the Community Literacy Council's annual Spelling Bee competition.

This was the 14th year of the spelling bee competition, held in October at Yazaki's Learning Center in Canton.

Community Financial has participated for the past five years. Presenting the Bruce D. Berry Memorial Traveling Trophy to the credit union's 2004 Spelling Bee Champion Team were Carol Saunders, president of the Community Literacy Council and Suzanne Stuchler, tutor coordinator. Community Financial's Champion Spelling Bee Team "Spellbinders" included employ-



ees Kim Kerr, lending quality analyst and Sue Bellaire, technical training coordinator. They bested 11 other teams that participated in the competition that was sponsored by local businesses.

"The team approach truly mirrors how we work together at Community Financial on a daily basis," said Bellaire, who also served on last year's winning team. More than \$4,000 was raised from the annual competition and will be used by the Community Literacy Council, Inc. to provide free tutoring to adults in western Wayne County who need help reading, writing and speaking English.

### People to People

Kristin Tarp, a student at St. Paul's Lutheran School, has been accepted into the People to People World Leadership Forum. Tarp will join a select group of students in Washington, D.C., April 11-17, 2005 to earn high school credit while studying leadership and exploring some of the United States' most prominent monu-

ments and institutions. Tarp was nominated and accepted for the honor based on outstanding scholastic merit, civic involvement and leadership potential.

### Holiday Shoppe and Pizza Night

Moraine Elementary is hosting a holiday shoppe and pizza night on Thursday, Dec. 2 from 5:30-7:30 p.m. This is a great event for families. The holiday shoppe offers kids a chance to purchase gifts for someone special. All gifts are \$5. All scout troops at Moraine have made "hand made" gifts to sell also. Kids can bring their allowance money and be able to purchase something for everyone on their list. Pizza, desserts, tea and coffee are available for purchase. No profit is made off of this event.

### Civic Concern donations

The Moraine Student Council is sponsoring a collection for Northville Civic Concern. Those wanting to help struggling families through the difficult holiday period and winter months can donate any of the following items: canned goods (especially canned fruit), paper products, soap, cereal, baby products and laundry products. The collection dates are Wednesday, Dec. 1 through Wednesday, Dec. 15. Boxes are located in the front hallway and by the Bus Loop entrance.

# The Perfect Family Gift

## Four Camera Phones & Unlimited Calling.

Get 4 Camera Phones with 1GB memory for ONLY \$49.99 after \$50 Mail-in Rebate

With new 2 year Agreement per phone. America's Choice plans \$39.99 @ 2004.

With Unlimited Calling, and many other features. Verizon Wireless customer within the America's Choice Coverage Area without using your plan minutes.

Hurry, While Supplies Last.

**verizon**wireless  
We never stop working for you.

Upgrade to America's Most Reliable Wireless Network

CALL 1.877.2BUY.VZW    CLICK [vzwshop.com/holiday](http://vzwshop.com/holiday)

## Are you an organ & tissue donor?

Ask your family today, and let them know your decision, too. That way you'll know, they'll know, and there will be no questions later. For a free brochure, call 1-800-355-SHARE. Share your life. share your decision.<sup>SM</sup> Michigan Coalition on donation



## SPOTLIGHT ON: ORTHODONTIC NEWS

by Donald M. Wayne, D.D.S., M.S.  
Orthodontic Specialist

### TOOTHY SMILES

Some individuals have more than the usual number (32) of permanent teeth in their mouths. Extra or supernumerary teeth occur more often among permanent teeth, than primary ("baby") teeth. The most common type of extra tooth is a small supernumerary incisor called a "mesiodens" (or "middle tooth"), which appears between the upper central incisors (top front teeth). The tendency to produce supernumerary teeth seems to be inherited. And, owing to the fact that they may be unsightly and cause orthodontic problems, they are usually extracted. This, of course, leaves a space in the middle of the upper dental arch. Fortunately, orthodontic treatment can be undertaken to fill any gaps left by extracted teeth and ensure proper bite.

Crooked and crowded teeth are hard to clean and maintain, which may contribute to conditions that cause not only tooth decay, but also eventual gum disease and tooth loss. Other orthodontic problems can contribute to abnormal wear of tooth surfaces, inefficient chewing function, excessive stress on gum tissue and bone that supports the teeth, or misalignment of the jaw joints, which can result in chronic headaches or pain in the face or neck. To schedule a consultation, call our office at 248-471-1581. Our office is located at 39595 W. Ten Mile Road, Suite 111.

P.S. Supernumerary teeth occur in 14% of the population.

## Don't miss our convenient extended holiday shopping hours.

VERIZON WIRELESS COMMUNICATIONS STORES			AUTHORIZED RETAILERS		
<b>ANN ARBOR</b> 2570 Jackson Ave. (Next to Blockbuster) 734-769-1722	<b>FAIRMINGTON HILLS</b> 31011 Orchard Lake Rd. (S.W. Corner of Orchard Lake Rd. & 14 Mile Rd.) 248-538-9900	<b>ROCHESTER HILLS</b> 3035 S. Rochester Rd. (At Auburn Rd.) 248-853-0550	<b>WESTLAND</b> 35105 Warren Rd. (S.W. Corner of Warren & Wayne Rds.) 734-722-7330	<b>BLAINEVILLE</b> Global Wireless 1-888-607-1800	<b>ROSSVILLE</b> Authorized Callstar 1-800-VIP-Plus
<b>BRIARWOOD MALL</b> (In Sear's Wing, Near Center Cl.) 248-253-1799	<b>FENTON</b> 17245 Silver Pkwy (In the Sear's Plaza) 810-629-2733	<b>ST. CLAIR SHORES</b> 26401 Harper Ave. (At 10 1/2 Mile) 586-777-4010	<b>WAL-MART LOCATIONS</b> Warren 29240 Van Dyke 586-751-0747	<b>BRIMLEY</b> Auto One Brighton 810-227-2808	<b>ROYAL OAK</b> Fusion Communications 248-549-7700
<b>ALBION HILLS</b> Great Lakes Crossing Mall 248-253-1799	<b>FT. GRATIOT</b> 4129 24th Avenue 810-385-1231	<b>SOUTHFIELD</b> 28117 Telegraph Rd. (South of 12 Mile Rd.) 248-358-3700	<b>OR VISIT THE VERIZON WIRELESS STORE AT CIRCUIT CITY</b>	<b>CLAWSON</b> Authorized Callstar 248-280-6390	<b>SOUTHFIELD</b> Wireless USA 248-395-2222
<b>BRIGHTON</b> 8155 Chalks, Suite C (Off Grand River, in front of Target) 810-225-4789	<b>GRAND BLANC</b> 12821 S. Saginaw St. (On Grand Blanc Mall) 810-606-1700	<b>STENING HEIGHTS</b> 45111 Park Ave. (M-59 & M-53, Uca Park Plaza) 586-997-6500	<b>ANN ARBOR</b> Circuit City	<b>CONCORD</b> Authorized Callstar 248-360-9400	<b>SOUTHFIELD</b> Wireless USA 248-395-2222
<b>CANTON</b> 24417 Ford Rd. (Corner of Ford & Lilley Rds., Canton Corners) 734-844-0481	<b>LAKE ORION</b> 2531 S. Lapeer Rd. (Orion Mall 2 Miles N. of the Palace) 248-333-6800	<b>TAYLOR</b> 23495 Eureka Rd. (Across from Southland Mall) 734-287-1770	<b>ANN ARBOR</b> Circuit City	<b>CONCORD</b> Authorized Callstar 248-360-9400	<b>SOUTHFIELD</b> Wireless USA 248-395-2222
<b>DEARBORN</b> 24417 Ford Rd. (Just West of Telegraph) 313-278-4491	<b>NOVI</b> 43025 12 Mile Rd. (Twelve Oaks Service Dr., North of Sear's) 248-305-6600	<b>TROY</b> 1913 E. Spig Beaver Rd. (Troy Sports Center) 248-526-0040	<b>ANN ARBOR</b> Circuit City	<b>CONCORD</b> Authorized Callstar 248-360-9400	<b>SOUTHFIELD</b> Wireless USA 248-395-2222
<b>FAIRFAX</b> 3rd Floor Next to Sear's 313-441-0168	<b>PONTIAC/WATERFORD</b> 454 Telegraph Rd. (Across from Summit Place Mall) 248-335-9900	<b>OAKLAND MALL</b> (Inside Main Entrance, next to Food Court)	<b>ANN ARBOR</b> Circuit City	<b>CONCORD</b> Authorized Callstar 248-360-9400	<b>SOUTHFIELD</b> Wireless USA 248-395-2222
<b>DETROIT</b> 14126 Woodward (Model T Plaza) 313-869-7392			<b>ANN ARBOR</b> Circuit City	<b>CONCORD</b> Authorized Callstar 248-360-9400	<b>SOUTHFIELD</b> Wireless USA 248-395-2222

\*Our Surcharges (incl. 1.95% Federal Universal Service (varies quarterly), 5¢ Regulatory/line/mo., & others by area) are not taxes (details: 1-888-644-1888); taxes apply. Activation fees: \$35/7 yr; \$15/2 yr. IMPORTANT CONSUMER INFORMATION: Subject to Customer Agreement, Calling Plan, rebate form & credit approval. \$175 termination fee per line, up to 45¢/min after allowance, other charges & restrictions. Usage rounded to next full minute. Offers not available everywhere. Rebate takes 8-10 weeks. Network details, coverage limitations & maps at [verizonwireless.com](http://verizonwireless.com). Nights 9:01 pm - 5:59 am M-F. Offer expires 1/30/05. ©2004 Verizon Wireless.



## “The Blues have better ideas for better health.”

*Ernie Harwell*

*“At Blue Cross Blue Shield of Michigan, we’re committed to helping our members live longer and live better. As the Blues’ Health and Fitness Advocate, I enjoy the chance to tell you about the many programs and services the Blues offer that can help us get healthy and stay healthy, and help keep quality health care affordable.”*



When it comes to your health, it's good to have connections.

When a medical condition suddenly changes your life, sometimes it's hard to know just where to turn or what to do. That's why we introduced BlueHealthConnection®—our personalized health management program that offers a variety of ways to help our members take charge of their health care. It offers a wealth of resources they need to navigate through health problems and lead better lives. Including access to professional nurses who can offer health education, tips, and hope. With BlueHealthConnection, you're always just a phone call away from sound information, the kind you can use to make the best health care decisions for you and your family.



Saving money with generic drugs is an easy pill to swallow.

One of the ways Blue Cross is helping our members save out-of-pocket expenses is by urging everyone to get the facts about generic drugs. The FDA requires generic drugs to meet the same standards for strength, purity and quality, and to contain the same active ingredients as the brand-name drugs. Which means that generics give you the same therapeutic effects—for less. To date, Blues members have saved more than \$15 million in out-of-pocket costs due to lower copays for generics. There are times when a generic equivalent is not available. But choosing a generic when possible can help hold down rising health care costs—and can add up to extra money in your pocket. To learn more about what generics can do for you, visit our Web site at [www.theunadvertisedbrand.com](http://www.theunadvertisedbrand.com).



WalkingWorks<sup>SM</sup> for us all.

Walking is the simple way to improve your health. Just three to five times a week for 30 minutes can make a big difference in your overall fitness and well-being. With the Blues' WalkingWorks program, we give our members a simple, easy and fun way to get the aerobic exercise needed for good health, with little risk of injury. It's a step we're glad to take to help folks live better—and help keep health care affordable for us all.

## Think of it as play-by-play for healthier living.

Look for Ernie's column each week in this newspaper.

For easy-to-follow advice on staying healthy, look for “Take It From Ernie.” This column, sponsored by Blue Cross Blue Shield of Michigan, brings you words of wisdom from Hall of Fame broadcaster Ernie Harwell.

Each week, Ernie highlights simple steps we can all take to improve our health and our quality of life. You'll find entertaining information on the benefits of walking, the value of using less expensive generic drugs and simple ways to stay healthy and fit. And nobody's a better example than Ernie himself, Blue Cross Blue Shield's Health and Fitness Advocate, who makes healthy choices and exercises every day at 86 years of age.

So read “Take It From Ernie,” and as Ernie says, “Take care of your health before it's lonngggg gone.”

## The truth about regular physical activity – at any age.

By Ernie Harwell



While it's not uncommon for some adults to think they're either too old or too frail to exercise, nothing could be further from the truth. Regular physical activity brings health benefits and greater well-being at any age.

Regular physical activity helps improve muscle strength, stamina, balance, joint mobility, flexibility, agility, overall physical coordination, metabolism, blood pressure, weight control, even the treatment and prevention of heart disease. It also helps slow bone loss and lowers the risk of developing adult onset diabetes. It even improves your mood.

Of course, I recommend three simple rules for regular physical activity in life's later innings: Have a physician on your team, take a lot of intentional walks and remember that, as Yogi Berra is fond of saying, “It ain't over 'til it's over.”

And please remember to take care of your health before it's lonngggg gone!

*Ernie Harwell, “the voice of the Detroit Tigers” for more than four decades, retired after 54 years behind a major league microphone. Today, at age 86, Ernie's days are filled with serving as a health and fitness advocate for Blue Cross Blue Shield of Michigan, public appearances, writing, traveling and taking long walks with “Miss Lulu,” his wife of more than 60 years. His latest book, a collection of his baseball columns titled “Life After Baseball,” is available at bookstores or by calling 1-800-245-5082.*



**Blue Cross  
Blue Shield  
Blue Care Network  
of Michigan**

[bcbsm.com](http://bcbsm.com)



# SHUTTLE: downtown bus ready to ride

continued from page 1A

## Worth a try?

"I think it's something we probably should give a shot," said downtown business owner Margene Buckhave. "I don't know if my employees will try it."

Co-owner with her husband Bob of the Old Church Square, which is also home to several retailers at the corner of Center and Dunlap streets, Buckhave said the group has been looking for creative solutions to the problem of insufficient parking. "I don't like the idea of spending the money."

Rick Shaffner, chairman of Main Street Bank at the corner of Hutton Street, called the shuttle concept "throwing good money after bad." He discounted concerns about security risks and the inconvenience of walking a little further to work.

"I think we're trying to appease a very, very small group of people."

Mayor Christopher Johnson, also development authority chairman, encouraged the group to look at the shuttle as a parking management program alternative. "We're kind of locked into a mindset. 'We need a deck.'"

Part of the staff recommendation was surveying riders during the initial seven weeks to help evaluate the success of the program. The shuttle costs include bus rental, driver pay, gas, scheduling and administration. The city's municipal liability policy covers insuring the endeavor.

A flyer distributed to downtown businesses Tuesday afternoon

informed them of the shuttle plan, route, timing, stop locations and trial basis. The sheet referred shuttle questions to DDA director Lori Ward's office (248) 349-0345.

The flyer also reminded downtown workers of free all-day parking lots on the south side of Cady Street, if they prefer to walk.

## Parking woes

The development authority's action followed recent removal of the remaining orange dots allowing permitted employees to park all-day in designated spaces in the two largest lots on the north side of Main Street. That move followed retailers' protest that employees took slots that could have been filled by patrons.

The route around the city's core blocks will take about 15 minutes, Gallogly said, depending on the number of riders. The route is all right turns to make it an easy loop, he said.

Parks and recreation department part-time drivers with the proper certification will drive the city-owned 22-seat bus, he said.

Shaffner said workers whose schedule does not fit within the shuttle's hours might object. Also, he said, people who come and go throughout the work day do not benefit from the service.

Ward said the parking committee developed a plan they thought would serve the majority of retail and office workers.

In the end, the majority concurred the concept was worth a try as a creative solution. A parking deck would be expensive and at least two years away.

## SHUTTLE FACTS

**HOURS**  
Drop off: 7:45-10:15 a.m.  
Pick up: 5-6:30 p.m.  
**Days:** Monday-Saturday  
**Trial basis:** Effective yesterday through Jan. 22.  
**Fare:** Free through the end of the year. Effective Jan. 3, the cost is \$1 per round trip ride.

**GIBBS UPDATE**  
Bob Gibbs of the Birmingham-based Gibbs Planning Group will return to town next week to deliver the results of his downtown Northville retail planning study. Parking, building height and number of buildings will be options discussed. Equipped with his findings, community leaders will work to reach consensus about which planning model Northville should pursue.

Meetings planned are:  
Dec. 9: Special Downtown Development Authority meeting 7 p.m., Thursday, Northville Senior Community Center, 303 W. Main St. After Gibbs presents his report, DDA members will ask questions; then the public.

Dec. 13: Steering Committee meeting 7 p.m., Monday, City Hall council chambers, 215 W. Main St.

## Calvin S. Niemi, 80

Calvin Niemi of Northville died Nov. 19, 2004. He was 80. Mr. Niemi was born March 2, 1924 in Detroit to the late Nestor Niemi and Melia S. Sedstrom.

Mr. Niemi lived in Northville for 41 years and was a graduate of Northwestern High School in Detroit. He was a pilot for General Motors and was a member of the Bethlehem Lutheran Church in Farmington. He was a member of the American Legion and was a charter member of the Yankee Air Force. He served in the United States Air Force during World War II. Cal enjoyed the outdoors and especially enjoyed traveling to East Tawas and Boyne City. He was known as "Gramps" to many, not just his adored grandchildren.

Survivors include two children, Nancy (Geoff) Nast of Highland and Jim (Karyl) Niemi of Canton; and four grandchildren, Dayna and Jill Niemi and Amy and Ryan Nast.

He was preceded in death by his wife, Audrey E. Niemi. A memorial service was held Nov. 23, 2004 at Bethlehem Lutheran Church, Farmington with Pastor Timothy R. Nilson officiating.

Memorials may be made to Bethlehem Lutheran Church, 35200 Eight Mile Rd., Farmington, Mich. 48335 or to the Pulmonary Fibrosis Foundation, 1440 West Washington Blvd., Chicago, Ill. 60607. Arrangements were made by Casterline Funeral Home, Northville.

## OBITUARIES

### Raymond E. Maise, 71

Raymond Maise of Northville Township died Nov. 21, 2004 at Henry Ford Hospital. He was 71. He was born in Detroit on May 11, 1933 to the late Alexander and Rose Maisevic.

He had worked for Ford Motor Credit in various executive positions for over 30 years. He was an avid golfer and loved to travel.

Survivors include his wife of 48 years, Barbara, five children, Paul (Kimberly), Peter (Carol), Phillip, Matthew (Dawn) and Jennifer (Andrew) Corneir, and ten grandchildren.

A funeral mass was held Nov. 24, 2004 at Our Lady of Victory Catholic Church. Memorials may be made to Personal Assisted Living Services. Arrangements were made by Northrop-Sassaman Funeral Home, Northville.

### Adam Szlavik, 82

Adam Szlavik died Nov. 22, 2004 in Plymouth Township. He was 82. Mr. Szlavik was born in Detroit on April 12, 1922 to the late Michael and Marie Szlavik.

He had served in the Army during World War II and was a member of the

VFW of Dearborn and the American Legion of Wyandotte. He had worked for 33 years for Detroit Diesel retiring in 1986.

Survivors include his wife, Virginia; two daughters, Patricia (Arnold) Nielson and Cynthia Szlavik; one granddaughter and two great-grandchildren.

A funeral was held Nov. 24, 2004 at Northrop-Sassaman Funeral Home, Northville with the Reverend Karen Henry of the Church of the Holy Cross of Novi officiating. Memorials may be made to the American Cancer Society. Arrangements were made by Northrop-Sassaman Funeral Home, Northville.

### Joan Howcroft, 82

Joan Howcroft of Canton, died Nov. 28, 2004 at Sunrise Assisted Living in Northville. She was 82. Mrs. Howcroft was born on Jan. 18, 1922 at West Derby, England to the late James C. Craven and Sarah Hayes.

She lived in Canton for 30 years, previously of Dearborn. She was a homemaker and of the Catholic faith. She enjoyed golfing and gardening.

Survivors include one daughter, Susan (Donald Rudy) Howcroft of Northville; one sibling, Winnie Stuart of England; and one granddaughter, Heather Rudy.

She was preceded in death by her husband, Kenneth Howcroft. Private family services were held. Arrangements were made by Casterline Funeral Home, Inc., Northville.

**The Italian-American Banquet and Conference Center of Livonia**

**New Year's Eve Celebration 2005**

**Dec. 31, 2004-Jan. 1, 2005**  
7 pm - 1:30 am

**\$85 Per Person • No Ticket Sales at the Door**

<ul style="list-style-type: none"> <li>• Hot and Cold Hors D'oeuvres</li> <li>• Dinner Served at 8:00</li> <li>Chicken Pastina Soup with Swiss Chard</li> <li> Linguine with Meat Sauce</li> <li> Garden Salad</li> <li> Individually Plated Filet Mignon</li> <li> Chicken Saltimbocca</li> <li> Anna Potatoes with Reggiano Cheese Sauce</li> <li> Rapini Sauteed in Oil and Garlic</li> <li> Vegetarian Plate Upon Request</li> <li> • Dessert</li> </ul>	<ul style="list-style-type: none"> <li>• Deluxe Bar</li> <li>• Champagne at Midnight</li> <li>• Red Wine served During Dinner</li> <li>• Espresso &amp; Cappuccino</li> <li>• Late Night Buffet</li> </ul>
--	--

**Live Entertainment by Atlantis**  
**Complimentary Valet Parking**  
**\$85.00 per person**

**Tickets Available M-F 9 am - 5 pm**  
**Call 734-953-9724 for more information!**

Must be 21 or older. Ticket deadline December 27  
Located at 39200 Five Mile Road, Livonia  
Between Newburgh & Haggerty Roads

**RESERVE NOW!**  
For ticket information please call  
(734) 953-9724

**Why wait for New Years to make your Resolution?**

**At Play It Again Sports, it's easy to start your training program today!**



**New Exercise Bikes.....from \$129**

**New Elliptical Trainers...from \$249**

**New Treadmills.....from \$399**

**Freeweight Packages....from \$59**



Come in today for a consultation with our trained fitness experts, and get a head start on your new years resolution.

**PLAY IT AGAIN SPORTS**

24287 Novi Rd. • Novi • North of Ten Mile in the Pine Ridge Center  
Mon.-Sat. 10am-8pm. Sun. 11am-5pm.  
**248.449.4544**

\*Limited to stock on hand

**DECEMBER TO REMEMBER SALE**

**Will beat all other deals**

**2005 LEXUS ES330**

**\$349\***

36 Months

Moonroof, CD Player, Premium Sound, Leather



**2005 LEXUS RX330**

**\$349\***

36 Months

Moonroof, CD player, Premium Sound, EWD



**2005 LEXUS GS330**

**\$439**

36 Months

Moonroof, 6 disc CD, Premium Sound, Leather



**2004 LEXUS GX470**

**\$499**

36 Months

Moonroof, 6 disc CD, Premium Sound, Leather



OPEN MON & THURS 9-9; TUES, WED & FRI 9-6; SATURDAY 10 - 5

**LEXUS OF ANN ARBOR**

590 Auto Mall Dr., Ann Arbor, MI  
866-645-3987 • 734-996-1662  
lexusofannarbor.com

**LEXUS OF LANSING**

5701 Pennsylvania Ave., Lansing, MI  
800-539-8748 • 517-394-8000  
lexusoflansing.com



**Travelpro<sup>®</sup>**  
USA

**50% Off Crew5**

Plus an Additional 10% Off



**Pilot Designed. Flight Crew Tested.**

A. Rolling Garment Bag Regular Price \$520.00 SALE \$233.99	B. 26" Upright Regular Price \$480.00 SALE \$215.99	C. 22" Upright Regular Price \$400.00 SALE \$179.99	D. Rolling Tote Regular Price \$280.00 SALE \$125.99	E. Deluxe Tote Regular Price \$140.00 SALE \$62.99
---	---	---	--	--

**POINT-A-LUGGAGE**

Twelve Oaks Mall  
27460 Novi Road  
Novi, Michigan  
248-347-7710

**SPECIAL OFFER!**

**CARRY-ALL TOTE FOR 14**

**\$30 VALUE WITH \$100 MINIMUM PURCHASE.**

Please present coupon at checkout to redeem.  
Expires December 24, 2004 or while supplies last.



0000562736

## ENGAGEMENTS, WEDDINGS AND ANNIVERSARIES



**Mr. and Mrs. William and Mary (Padget) Craft**

Mary Padget and William Craft were married Nov. 26, 2004 at Fountain Street Church in Grand Rapids. The bride was given in marriage by her sons, John and James Padget. A reception was given by Barbara Craft Otterbacher.

The bride is a graduate of Cass Technical High School and is a Registered Nurse for Assisted Living. The groom is a graduate of Northwestern High School, Detroit. He is retired, formerly a Principal at Amerman Elementary.

Anne and Carol Padget, daughters of the bride, were maids of honor. George Craft, brother of the groom, served as best man.

The couple will make their home in Northville.



**Mr. and Mrs. Fergus Johnson**

Sarah Anne Reynolds and Fergus Alpin Johnson were married Sept. 18, 2004 in Ann Arbor with Matt Sanford officiating the ceremony. A reception was held at Cobblestone Farms, Ann Arbor following

the ceremony.

The couple and their families had a second ceremony and celebration, Sept. 22, 2004 in Kirkcaldy, Scotland, home of the groom's parents. The ceremony was held at the Ravenscraig Castle Ruins and the reception was held at the Strathearn Hotel.

The bride is the daughter of Mike and Becky Reynolds of Northville. She is a graduate of Northville High School and Eastern Michigan University. She is a registered dietician at Lodi Hospital and will be entering graduate school at Samuel Merritt College in Jan. 2005.

The groom is the son of Dr. Roger and Mrs. Frances Johnson of Kirkcaldy, Scotland. He is employed by the Sacramento Fire Department.

Attendants for the bride were Amy (Arnold) Duncan, Jessica Meredith, Becky Gale, Justin Jezewski and Anthony Frizzeue. Attendants for the groom were Dana Middaugh, Matt Sanford and Aidan Dysart.

The couple will make their home in Sacramento, Calif.



**Mr. and Mrs. Dan Loftus**

Annie Marrs of Northville and Dan Loftus of Estes Park, Colorado were married on July 10, 2004 at Bay Harbor Resort in Petoskey, Mich.

The bride works in marketing management in Chicago

and is the daughter of Mr. & Mrs. Laurie and Terry Marrs of Northville. She is a graduate of Michigan State University where she received a BA in Communications.

The groom also works in marketing management in Chicago and is the son of Mr. & Mrs. Judy and John Loftus of Estes Park Colo. The groom is a graduate of University of Colorado where he received a BA in Business.

The couple reside in Chicago, but have plans to move west in the near future.

## ANNIVERSARY



**Mr. and Mrs. Valrance**

Jim and Jean (Lumsden) Valrance celebrated their 60th wedding anniversary on Thanksgiving weekend with their family at a party at Meadowbrook Country Club. They were married in Royal Oak on Nov. 18, 1944. Their family includes three children, Judy (Jim) Kohl of Northville, Jim (Nancy) Valrance of Lake Wylie, S.C., and Burt Lake, Mich. and Joan (Brad) Whittlesey of Englewood, Colo.; six grandchildren, Tracy (Jeff) Darrow of South Lyon, Wendy (Jim) Hazlett of Sarasota, Katie Kohl of Ward, Colo., Amy Kohl of Denver, Jim Whittlesey of Boulder and

Megan Whittlesey of Englewood; and three great-grandchildren; Margaret and Alex Darrow and Jimmy Hazlett. Jim and Jean met at Michigan State University and live in Novi and Burt Lake.



**Mr. and Mrs. Martin**

Jack and Jane Martin of Northville celebrated their 40th wedding anniversary with a trip to Las Vegas and a family party. They were married November 25, 1964 at St. Alphonsus. They are longtime Northville residents (30 years) who belong to Our Lady of Victory Church and put four children through Our Lady-of-Victory school.

Jack has worked for AAA of Michigan for 40 years and is currently still employed there as Manager of Claims Quality Assurance. Jane is a homemaker and artist who exhibited in the Ann Arbor Art Fair for 12 years. She is an artist of pen and ink drawings.

Their family includes four children, Kristen (Larry) Schlagheck of Northville, Lisa (Chad) Wiltrakis of Ann Arbor, Erin (Scott) Krueger of Farmington Hills and J.P. Martin of Birmingham. They have seven grandchildren with one due in February.

## ENGAGEMENT



**Parker-Pohlonski**

Craig and Linda Parker of Novi announce the engagement of their daughter, Emily, to Brent Pohlonski, son of Ronald and Jill Pohlonski of Holt, Mich.

The bride-elect is a 1996 graduate of Novi High School and a 2000 graduate of Michigan State University. She is currently a science and math teacher and a cheer coach at Novi High School.

The groom-elect is a 1989 graduate of Holt High School and a 1993 graduate of Ferris State University. He is currently employed as a swim coach for Holt High School and a math teacher for Lansing Everett High School. A July 2005 wedding is planned.



**MacPhail-Freers**

Mrs. Christina MacPhail and the late Norman MacPhail of Northville are pleased to announce the

engagement of their daughter, Marina, to David Howard Freers, son of Howard and Eleanor Freers of Bloomfield Hills.

The bride-elect is a 1986 graduate of Redford Union High School and is currently employed by Dr. Jeff Daws, D.D.S.

The groom is a 1982 graduate of Lahser High School and a 1986 graduate of the University of Michigan. He is self-employed as an automotive photographer.

A September, 2005 wedding is planned.

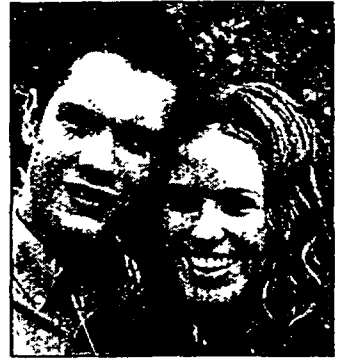

**Risher-Lewis**

Ron and Mindy Risher of Northville announce the engagement of their daughter, Jaclyn Risher to Stephen Lewis, son of John and Dawn Lewis of Greenville, Mich.

The bride-elect is a 2002 graduate of Northville High School and is currently attending Calvin College, graduating in 2006.

The groom-elect is a 2001 graduate of Greenville High School and is currently attending Cornerstone University, graduating in Dec. 2004.

A July, 2005 wedding is planned.

**CRUISEONE**  
#1 In Cruising, Nationwide  
EASTER BREAK FAMILY CRUISE

March 27, 2005  
Carnival Miracle...  
7 Night Western Caribbean  
From \$902

Price is cruise only, per person, based on double occupancy and includes port charges. Restrictions apply. Gov't taxes/fees additional.

TO BOOK CALL  
**JIM ROZELLE**  
Your Independent Cruise Specialist  
Westland, MI  
(734) 736-4095  
www.mlcruise.com

**Carnival**  
Just more fun...  
Ships' registry: Panama and The Bahamas

**New Year's Eve Under the Stars at Burton Manor**

A memorable evening of fine dining, dancing & entertainment

Friday, December 31  
8:00 pm - 2:00 am

\$150 per couple includes:

- \* Valet parking
- \* Reserved seating
- \* Premium bar package
- \* Live entertainment by Rare Blend
- \* Strolling supper & sweet table
- \* Hats, noisemakers
- \* Champagne toast at midnight
- \* Afterglow with pizza snack

Purchase tickets Mon-Sat, 9:30 am-4:30 pm

Cash and money orders welcome (checks until Dec. 15)  
Must be 21 & over to attend

**Burton Manor**  
BANQUET AND CONFERENCE CENTER  
2777 Schoolcraft Rd. Livonia  
734/427-9110

**"He has my respect, undying loyalty to my company, and the health care I decided he should never do without."**

You've got a lot of responsibility. Your employees not only work for you—they depend on you. Making sure they get good health care lets them know you've got their interests at heart. And nothing says that better than Blue Cross Blue Shield of Michigan:

- Statewide and nationwide acceptance—coverage no other company can match
- A variety of flexible plan options, including a plan that works for you
- More of every dollar going to health care—just 9¢ to administration
- Easy access to doctor and health information on the Web and over the phone
- Discounts on health- and safety-related expenses, like bike helmets and Weight Watchers®
- Reliability—65 years of continuous service in Michigan

In addition, Blue Cross is the only health plan that accepts everyone, regardless of history, health or age—without a physical exam. And you never have to worry about an employee with health problems losing coverage.

"For my company, for employees like this one, I want the best I can afford. I want Blue Cross Blue Shield of Michigan. For me, it's just the right thing to do."

Call your independent agent or Blue Cross at 1-800-464-2583.



Michigan's most trusted name in health care.

bcbsm.com

Blue Cross Blue Shield of Michigan is an independent licensee of the Blue Cross and Blue Shield Association.



# Theater 'Origins'

## New group will perform at Northville High School tonight

By Kim Kovel  
RECORD STAFF WRITER

Northville's Main Street boasts a thriving children's theater scene at the Marquis and dinner shows at Genitti's.

Plymouth-based artistic director Tim Hayden hopes to soon add another brand to the mix: semi-professional acting with comedic flair.

"There's a lot of comedy out there," Hayden said. "We wanted to get back to the roots of... classic American theater. More of the family fare: 'The Odd Couple,' Neil Simon stuff... 'You Can't Take It With You,' 'The Man Who Came to Dinner.'"

The concept is called the Origins Theatre Company. Tonight at 7 p.m., with the help of the Northville High School Drama Club, they'll bring their first improvisation show, "An Evening of Laughs," to life at the high school.

For \$5 per person at the door, the show will feature a scaled-down stage and audience interaction, facets Hayden hopes to make permanent.

"I'd like to see smaller shows, smaller casts in a theater that seats no more than 100," said Hayden, who coaches forensics and speech at Northville High School. "The cast would be readily available to the audience after the show and answer questions."

A veteran of Second City in Detroit, Planet Ant Theatre in Hamtramck and various regional and dinner theater groups, Hayden hopes to incorporate

elements jotted in a notebook over his 15 years of performing travels.

He's founding the group with his wife, Sue, and friend Dan Glomski, and they're aiming for casts of about 10-12. Hayden said he's also eyeing musicals with small casts such as "I Do! I Do!" and "Between Daylight and Boonville."

Hayden wants to create a chance for locals to work with professionals, including veterans of Second City, Planet Ant and "Tony and Tina's Wedding." "We're not going to come into Northville... and say, 'Here's this professional company of actors, come and watch us do shows,'" Hayden said. "We really want to tap into the community. We'll audition locals."

"I'd love to see high school people involved. We never know where that next star is going to come from."

Tonight's show is an effort to raise funds to find a permanent home.

High school drama advisor Christina Lombardo said students will help set up and tear down the set and even jump on stage.

"This is a great opportunity for them to get involved with a very grassroots organization," Lombardo said. "The drama club exposes them to as many different types of theater as possible. I would love to really see it come to fruition."

Training workshops are also in the plans, Hayden said. Origins aims to run a three-weekend show starting mid-February.

"The drama club exposes them to as many different types of theater as possible. I would love to really see it come to fruition."

Christina Lombardo  
Drama Advisor, Northville High School

### LAUGH IT UP

What: Origins Theatre Company, a semi-professional theater group, presents "An Evening of Laughs" with the Northville High School Drama Club. The improvisational comedy show will feature veterans of The Second City, Planet Ant Theatre and "Tony and Tina's Wedding."

Why: Origins is raising funds to find a permanent Northville home.

When: tonight at 7 p.m.  
Where: Northville High School Auditorium.

Cost: \$5 tickets available at the door.

For more information, call (734) 674-8653.

"Everybody gets something out of it," he said. "Ultimately we would love to have a home of our own (or) share a space."

Kim Kovel can be reached at (248) 349-1700, ext. 107, or via e-mail at kkovelle@ht.homecomm.net.

# Irish eyes: Nellie Mills turns 100

By Kim Kovel  
RECORD STAFF WRITER

Though born in Manchester, England 100 years ago, Nellie Mills is an Irishwoman.

"She was very proud of her Irish heritage," daughter Kay Richardville said. "She said, 'I might have been born in England, but don't you call me English.'"

Mills' children took a leprechaun cake to their mother's Northville Star Manor home to celebrate her Nov. 22 centennial.

Richardville said her immigrant mother, who now has dementia, arrived in the Michigan at age 17 with her 19-year-old sister.

"Her father was reported missing in action in the first World War, so her mother was left to raise the family," Richardville said. "They came over here to work, to earn money."

Mills met husband Lawrence frosting cakes at a Detroit bakery. They sent their five children to Catholic schools.

"Her family was pretty much her life," Richardville said. "We went to visit her mother every Sunday."

Mills gained citizenship in 1951. Richardville recalls a hard-



Northville resident Nellie Mills turned 100 Nov. 22.

working woman who kept begonias in her garden, carted laundry up three flights of stairs and sewed, knitted and crocheted.

"She used to read to us when we were kids. That was always a special time," she said.

A bargain shopper, Mills took her kids Downtown Detroit by bus for month-end sales and homemade ice-cream waffles.

She now has 12 grandchildren and 19 grandchildren and has

lived in the Northville nursing home for about three years.

"She never smoked and drank very little," Richardville said. "She ate just about anything she ever wanted. She (is) very strong-willed person."

Kim Kovel can be reached at (248) 349-1700, ext. 107, or via e-mail at kkovelle@ht.homecomm.net.

## VARSITY LINCOLN MERCURY COLLISION CENTER

2 exits west of 12 Oaks Mall at Grand River and Wixom Road  
1-248-449-6901

PEOPLE'S CHOICE AWARD WINNER  
"BEST COLLISION SHOP" 2003

It's your choice so choose the best!

Tell your insurance company

"I'm going to Varsity Lincoln Mercury's Collision Center"

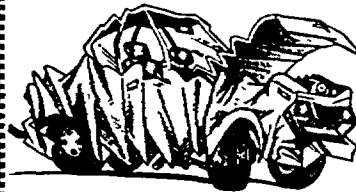

- We Repair All Makes & Models
- Direct Repair For All Major Insurance Companies
- Guaranteed On Time Repairs
- 90 Days Same As Cash On Your Collision Deductible\*

Varsity Collision Center Special\*  
Save this in case of an accident for  
**FREE TOWING**  
Courtesy of Varsity Lincoln Mercury Collision Center  
248-896-8888

Varsity Collision Center Special\*  
**FREE Collision Loaner**  
Courtesy of Varsity Lincoln Mercury Collision Center  
248-449-6901

## Are you an organ & tissue donor?

Ask your family today, and let them know your decision, too. That way you'll know, they'll know, and there will be no question later. For a free brochure, call 1-800-355-SHARE. Share your life, share your decision. Michigan Coalition on donation.



One Bite And You'll Be Hooked

## Fresh Seafood Flown in Daily

Specialties: Steaks, Chicken, Crab Legs, Crabs Cakes, Lobster, Pastas

The original Leon's has taken a new look and a new menu for the past 1 1/2 years. However, Leon's will never forget the friends and our family of 22 years!

Moe's on Ten is now bringing back the taste of the original Leon's to our Sunday Brunch. BEST IN NOVI!

We'll make your omelet to order right in front of your eyes!! Also, includes fresh fruit, sweets, waffles, bacon, sausage, french toast, sweets, rolls, chicken quesadilla and much, much, more. All for only \$7.95!!

39455 West Ten Mile Road • Novi  
(Just West Of Haggerty) • 248.478.9742

Mon. - Thurs. 11am - 10pm • Fri. 11am - 11pm • Sat. 4pm - 11pm • Sun. 9am - 9pm

## COMPLETE HOLIDAY DECOR

### FRESH CUT TREES!

NEW FOR 2004  
Vintage Noble Fir

- \* Premium Firs
- \* Trees from 3' table tops to 14' majestics
- \* Custom flocking available
- \* Over 1000 trees

### MAKE IT A FAMILY OUTING

Bring the entire family and visit our winter activities while you select your tree and fresh greens. Saturday and Sunday 11-3pm:

- FREE Pictures with Santa
- Petting Farm
- Cider and Donuts
- Hayrides • Campfire

### LIFELIKE TREES 25-50% OFF

Huge selection of styles and heights, including pre-lit trees. Super-lit available with double the standard number of lights. Quality, well constructed trees.

### \$5.00 OFF

Any Fresh Cut Christmas Tree 6' or Larger

Limit one coupon per customer. Not valid with any other offer. 12/8/04

### \$7.99 POINSETTIAS

6 1/2" POT REG. 9.99

Other sizes and prices available. Many styles to choose from.

### 18" BALSAM FIR WREATH \$7.99 REG. \$10.99

PLYMOUTH NURSERY  
Christmas in the Country

734-453-5500

www.plymouthnursery.net

HOLIDAY HOURS:

Mon-Fri 9-8 • Sat 9-6 • Sun 10-6

Offers Expire 12/8/04

9900 Ann Arbor Rd./Plymouth Rd.

7 Miles West of I-275

1 1/2 Miles South of M-14

Corner of Gotfredson Rd.



WHEN YOU HAVE QUESTIONS, WE HAVE HIGH TECH ANSWERS.

These doctors have access to the most up-to-date technology available in diagnostic services. Our Cardiac Scoring CT Scanner can quickly and painlessly determine your potential risk for a heart attack. Our RE.T. Scanner can give doctors a more detailed image for cancer treatment. And if your doctor recommends a virtual colonoscopy due to a family history of colon cancer, you can have that done at St. Mary Mercy Hospital, too. You see, we have the technology and the board certified diagnostic specialists to get the answers you need.

Come to St. Mary Mercy Hospital and discover the great technology that's right in your own backyard. To schedule a diagnostic test, contact your physician or call (734) 655-2961.

ST. MARY MERCY HOSPITAL

DIAGNOSTIC SERVICES  
Livonia, MI

Physician Referral  
Call 1.888.464.WELL

www.stmarymercy.org

GREAT TECHNOLOGY IN YOUR OWN BACKYARD

MRI • PET Scans • Interventional Radiology • Virtual Colonoscopy

24-hour Emergency • Cardiac Scoring CT • Endoscopy • Colonoscopy

**POLICE BRIEFS**

**Township**

**Woman found with cocaine**

Pulled over for an expired license, a Dearborn Heights female also was charged with intoxicated driving and possessing cocaine.

Township police stopped the female's car on Six Mile Road west of Haggerty Nov. 25 at 2:23 a.m. According to the report, her blood-alcohol content was .13. The legal limit in Michigan is .08. Police said they discovered paper-wrapped packs of powder in the female's pocket and another in a cigarette pack. Both tested positive for cocaine.

**Found: mailboxes, palm pilot, dog**

Lost items were found in the township last week, police said.

Damaged USA Today and HomeTown Newspapers mailboxes were found Nov. 21 in Hines Park near Northville Road. A gum ball machine also was found; damages were \$175.

The next day at noon, a silver

Sprint PalmOne Treo palm pilot was located in Pickford Road, near Edenberry Road. A tan and white Husky female dog was found Nov. 23 near Winchester and Elk roads. She's about 2 years old and is being kept at a pound. For information, call township police at (248) 349-9400.

**House party busted**

Two township residents Nov. 24 faced charges of an open house party and contributing to minors' delinquency.

Responding to a noise complaint, police arrived to the 18000 block of Seven Mile Road at 3:09 a.m. The 24-year-old male leaseholder who opened the door "appeared intoxicated," police said. The male and other leaseholder said they were having a get together because they were moving and knew the music was loud.

Officers said they heard "Shh" sounds from a bedroom; entering the room, they found eight subjects hiding in closets. Four were between the ages of 15-17. Breathalyzer tests allegedly found

evidence of drinking in three; a 17-year-old exceeded the legal limit at .09 BAC.

Minors were turned to their parents, and the leaseholders have a court date of Dec. 9.

**Marijuana grower gets caught**

Marijuana plants and assorted guns were found in a Northville man's township apartment by police.

Receiving a tip Nov. 16, police got a search warrant, entering Northville Place Drive home Nov. 18 at about 10 a.m. They reported finding three marijuana plants, electric timers and heaters and handwritten marijuana-growing instructions. A marijuana water pipe and narcotic paraphernalia also were allegedly discovered, along with two loaded handguns, a loaded shotgun and various long guns. All items were confiscated.

Police said the male admitted to owning the items. Charged with manufacturing and delivering marijuana and possessing narcotic paraphernalia, his court date is today.

	Housing Units
Canton Twp.	11,212
Novi	6,317
Northville Twp.	3,654
Van Buren Twp.	3,300
Farmington Hills	3,063
Westland	2,898
Plymouth Twp.	2,274
Livonia	2,072
Huron Twp.	1,661
Romulus	1,424
Sumpter Twp.	1,018
Wayne	407
Belleville	333
Northville	142
Plymouth	108
Farmington	38

**Residential Construction by Housing Unit Type 1993-2003**

- Single-Family
- Two-Family, Multi-Family
- Mobile Homes

Source: SEMCOG

**Are you an organ & tissue donor?**  
 Ask your family today, and let them know your decision, too. That way you'll know, they'll know, and there will be no question later. For a free brochure, call 1-800-355-SHARE.  
 Share your life share your decision. Michigan Coalition on donation



JIM ALLEN, Northville fire chief, and other members of the city of Northville's fire and rescue team, outside the city's fire hall.

**Nearly everyone reads the Northville Record**  
 Don't be the last to find out what's going on.  
**Call 1-888-840-4809**  
 to become a subscriber.  
**Northville Record**

**REMEMBER, ONLY YOU CAN PREVENT FOREST FIRES**  
 A Public Service of the USDA Forest Service and Your State Forester.

**SAVE BIG ON ALL BLINDS & WALLPAPER**

**FREE Shop-at-Home Service**  
 We'll bring the store to you! Let our team of trained professionals help you choose the style and color that's best for every room of your home. Select from a full assortment of blinds, window shades, shutters, curtains, top treatments and more!  
 Call 800-391-4823 and press "2" for a FREE appointment and details.

**Always 25%-85% Off**  
 most retail store prices  
**FREE MEASURING & INSTALLATION\***  
\* On all blinds orders over \$750 before sales tax. There is a \$55 refundable measuring deposit required for the measuring and installation. Offer does not apply to shutters, draperies and top treatments. Offer applies to Shop at Home and Showroom purchases. Please mention code NRTH or present coupon when placing your order.

**American BLINDS, WALLPAPER & MORE**  
 www.americanblinds.com  
**800-391-4823**

**Shop our Showrooms!**  
 Sterling Heights located at 19 1/2 Mile Road between Merrill Road and Utica Road  
 Plymouth located at 909 N. Sheldon Road just South of M-14  
 Showroom Hours: Mon-Fri 9:30am-7pm Sat 9am-6pm Thur 9:30am-9pm Sun 11am-5pm

Levolor® • Duette® • Kirsch® • American® • Silhouette® • Hunter Douglas® & more

**HOLIDAY SPECIAL**

**Win a Night at the Movies**

Place your 4 line private party ad in all of our HomeTown Newspapers Greensheet Classifieds for 2 weeks for \$40.00 and we'll enter your name in a drawing to win 2 tickets to Brighton Towne Square Cinema 20.

**2 winners will be randomly drawn each week.**

**Call 888-999-1288 and place your ad today!**

**HomeTown Green Sheet CLASSIFIEDS**

Commercial advertisers not eligible for this offer. No cancellations. Other restrictions may apply. No purchase necessary.

**Oh Baby!**

On Feb. 3, 2005, the Livingston County Daily Press & Argus will be launching a new special section entitled, "Oh Baby!" and your baby could be the main attraction.

This new section will feature photos of all babies born in 2004, along with editorial and advertising for new parents.

Each participant will receive a space similar to this:

Christina Louise Smith  
 March 22, 2004  
 Saint Joseph Mercy Livingston  
 Mike and Mary Smith

**Oh Baby!**

To publish your 2004 arrival in Oh Baby!, send a photo and \$20 to:  
 HomeTown Newspapers  
 P.O. Box 230P  
 Howell, MI 48844  
 Attn: Leslie.

All entries must be received by Jan. 12, 2005.  
 Include a SASE if you want your photo returned. **PRESS ARGUS**

Please Print  
 Child's Name (First, Middle & Last) \_\_\_\_\_  
 Date of Birth \_\_\_\_\_ Hospital \_\_\_\_\_  
 Parents' Name (First & Last) \_\_\_\_\_  
 Address \_\_\_\_\_

My check for \$20 is enclosed.  
 Please bill my  Visa  MasterCard  American Express or  Discover card.

Credit card number \_\_\_\_\_ Exp. Date \_\_\_\_\_  
 Signature \_\_\_\_\_ (Required) Phone \_\_\_\_\_



# Around Town

## Take a soldier to the movies

Center Stage Dance Co. is preparing a special presentation for wounded service personnel.

The dance studio, located at 43334 W. Seven Mile Rd., Suite 250, will be accepting the following items through Friday, Dec. 10, to create care packages to be sent to soldiers:

- new or used DVDs
- microwave popcorn packets
- candy
- AT&T phone cards.

Center Stage will package the donations and mail them, in time for the holidays, to the Landstuhl Regional Medical Center in Germany where serious casualties coming out of Iraq and Afghanistan are flown.

For more information, call (248) 380-1666 or write CSDC5678@aol.com.

## Go tartan today

The Pendleton Shop, 117 N. Center St., is hosting a Holiday Tartan Party 10 a.m.-9 p.m., Dec. 2.

The staff is offering free gift wrap, free shipping and prizes to visitors. Anyone who wears his or her favorite Pendleton plaid will receive a special surprise.

## Fashion tonight

VanDam's is hosting a Girls' Night Out 5-8 p.m., Dec. 2, at the 111 E. Main St. store.

Visitors will enjoy wine, hors d'oeuvres and holiday specials. For more information, call (248) 449-4282.

## Special shopping

Orin Jewelers is hosting special "Nights Out" for local ladies and gentlemen on upcoming Tuesdays.

On Dec. 7, women are invited 5-8:30 p.m. for cocktails and hors d'oeuvres while trying on jewelry. On Dec. 14, men are invited 5-8:30 p.m. for beer, pizza and private shopping. There will be special gifts and a shopping spree drawing both nights.

## Giant gingerbread

Northville Gourmet is renewing a Christmas tradition by giving away a giant gingerbread house.

The store's pastry chef Sue Posier, formerly of Crawford's Bakery, is creating the over-sized sweet. The gourmet store, 680 W. Eight Mile Rd., will draw the gingerbread house winning name Dec. 23.

Customers placing orders for Christmas hors d'oeuvres, pies,

pastries and dinner rolls can fill out an entry form while at the store. For more information, call (248) 349-5611.

## Street closures

The Arthritis Foundation will hold the 17th Annual Jingle Bell Run/Walk for Arthritis in Northville Sunday morning.

The 3.1-mile race route will start and finish on the Northville Downs racetrack. Road closures begin 8-10 a.m. on Center Street between Cady and Fairbrook streets.

Other road closures 8:30-10 a.m. begin when participants exit the track headed north on Center Street. The route is east on Rayson Street, east on Lake Street, north on Novi Street, east on Rouge Street, west on Baseline Road, south on Grace Street, west on Lake Street, south on Center Street, west on Dunlap Street, south on Linden Street, east on Main Street, south on Wing Street, west on Cady Street, south on First Street, east on Fairbrook Street.

## Lots to do at Maybury

Children are invited to bring homemade ornaments to hang on the Christmas tree at the Maybury Farm.

Weekend family activities include Christmas song sing-alongs, stringing cranberries and popcorn, and enjoying snacks and warm beverages at the welcome center 1-4 p.m., Dec. 4, 5, 11, and 12. Hayrides or sleigh rides (with weather cooperating) also will be offered through Dec. 20.

Maybury Farm is selling fresh greens shaped as candy canes, swags and wreaths this holiday season.

The wreaths, ranging from \$20-30, are available through Dec. 20. Each wreath purchased will have hung on one of the Maybury Farm barns.

The welcome center also has a variety of candles, votives and other items for sale. Donations will help rebuild the working farm destroyed by fire in February 2003.

Maybury Farm is located on Eight Mile Road, 1.5 miles west of Beck Road. For more information, call (248) 374-0206.

## Catch Cinderella

The Canton Youth Theater this weekend will present Rodgers and Hammerstein's "Cinderella" at the Village Theater at Cherry Hill in Canton.

The Dec. 2-5 performances of this classic fairy tale will charm audiences of all ages with its time-

less music and beloved heroine. Artistic sets, beautiful costumes and clever magical transformations invite everyone into this fanciful world of "dreams do come true" and "happily ever after".

For more information, call the Village Theater box office at (734) 394-5460.

## Grief and the holidays

Ward Presbyterian Church is sponsoring a holiday workshop 7-8:30 p.m. Monday, Dec. 6, for those who are grieving.

All adults who have experienced the loss of a loved one are welcome to attend the free workshop presented by Cathy Clough, director of New Hope Center for Grief Support. Ward Church is located at 40000 Six Mile Road in Northville.

There is no need to register in advance. For more information, call (248) 374-5966.

## City Hall notes

Northville city winter tax bills will be mailed this week. Taxes are payable without penalty through Feb. 14, 2005.

The city is auctioning off printers. For more information, visit <http://my.bidcorp.com/NVillMI/index.asp>

## Getting neighborly

The Northville Newcomers and Neighbors club will host its annual holiday party 6-8 p.m., Wednesday, Dec. 8, at the Toll Brothers' Villas of Northville Hills condo model home off Sheldon Road.

The evening will include music, decorations, appetizers and punch. Members' handmade gift items will be available for purchase.

To join the Newcomers and Neighbors club, call membership chair Andrea Sellers at (248) 446-1246. Annual dues are \$20. Prospective members may attend one function before joining. The group encompasses Northville and surrounding towns.

## Donation drop-off site

The agents at Century 21 Town and Country are working with



Submitted Photo

## VIP Premiere

The movie, "The Five People You Meet in Heaven" based on Mitch Albom's book, premiered Nov. 22 at the Star Theatre in Southfield as a fundraiser for Childhelp USA and the Purple Rose Theatre. Co. Among those attending were film stars Michael Imperioli (left), Albom, Jeff Daniels, Northville residents Barbara and Ed Jamieson, film stars Steve Grayhm and Dagmara Dominczyk. The movie, filmed earlier this year in British Columbia, will air on ABC at 8 p.m., Sunday, Dec. 5. The Jamiesons were invited to the V.I.P. dinner and movie, which raised nearly \$70,000, as patrons of the Purple Rose Theatre.

Northville Civic Concern to provide food and household items of needy local families.

The real estate firm's 175 CadyCentre office will serve as a drop-off point for donations through December. The lobby door is accessible from the public parking area off Mary Alexander Court, just east of Center Street.

Items needed are: household cleaning products, baby care products, diapers of all sizes, health and grooming products and non-perishable food.

For more information, call Amy Zubor or Karen Woodruff at (248) 349-5600.

## Blankets needed

Edward Jones investment representatives David Boyd, Todd Knickerbocker and Chris Willerer are supporting the American Red Cross Blanket Days program by using their offices as a drop-off

location for this year's blanket drive.

Local residents can help the homeless in the area by bringing in a new blanket to their Northville offices at 117 E. Dunlap, 128 N. Center St. and 1039 Novi Rd. Hours are 9 a.m.-5 p.m. through Jan. 31.

## He's in town

Visit Santa at his special house in Northville near the Main Street bandshell 6-9 p.m., Fridays and Noon-3 p.m., Saturdays and Sundays through Dec. 19.

## "Hope is Just Around the Corner"

Northville Christian Creative Arts and the Livonia Symphony Orchestra are joining this year to present the holiday musical, "Hope is Just Around the Corner."

It's a story set in 1941 with relevant themes for today. The strong bonds of family, the golden days of radio and a nation on the brink of war are all elements of this dramatic production. Audiences will enjoy the drama, the humor and the '40s music and costumes as this Christmas presentation answers the question, "Where can a family turn for hope in difficult times?"

Performance times are Friday, Dec. 17 and Saturday, Dec. 18 at 7 p.m. and Sunday, Dec. 19 at 3 p.m. and 7 p.m. Tickets are \$8 in advance and \$10 at the door. Northville Christian is located at 41355 Six Mile Road, about one mile west of I-275. For information, call (248) 348-9030.

To contribute an item for consideration in this column, e-mail [mjohnston@ht.homecomm.net](mailto:mjohnston@ht.homecomm.net).

**CHARTER TOWNSHIP OF NORTHVILLE**  
**Notice of Rate Increases Solid Waste Collection**

The following monthly solid waste (refuse, recycling and yard waste) have been adjusted as follows and are effective December 17, 2004. The new rates will be reflected on the December 17 billing for two month period that follows that date. The rate changes are as follows:

Collection	Present Rate:	New Rate:
	\$ 10.00	\$ 14.00

SUE A. HILLEBRAND, CLERK  
 CHARTER TOWNSHIP OF NORTHVILLE  
 (11-4 & 12-2-04 NR 176084)

**CHARTER TOWNSHIP OF NORTHVILLE**  
**NOTICE OF PUBLIC HEARING**  
 DATE: THURSDAY, DECEMBER 16, 2004  
 QUAIL RIDGE STREET PAVING  
 SPECIAL ASSESSMENT DISTRICT (SAD)

To the residents and property owners of the Charter Township of Northville, Wayne County, Michigan, and any other interested persons:

PLEASE TAKE NOTICE that pursuant to State Statute MCL 41.724a, a public hearing will be held at the Township Hall, located at 44405 Six Mile Road, Northville Township, Michigan on Thursday, December 16, 2004 at 7:30 p.m. regarding the Quail Ridge Subdivision Paving SAD. This type of public hearing is necessary when project costs exceed original estimates in excess of 10%. This public hearing is being held for the Township Board to approve the additional costs associated with the construction of the project.

SUE A. HILLEBRAND, CLERK  
 (12-29-04 NR 181882)

**Alden**  
 Our Full Strap Slip-On Casual Elegance Achieved

**Cobbler's Corner**  
 SHOES & SHOE REPAIR  
 104 E. Main St. • Downtown Northville  
 248-348-6114

Hours:  
 Mon-Fri 9-5  
 Sat 9-4

ENTER THE WORLD OF ERHARD  
**LAND ROVER**  
 FARMINGTON HILLS

**MONTH END CLOSE OUT!**

On Brand  
**NEW 2004 DISCOVERY SE**  
 Buy for as low as  
**\$29,995**

Hurry in, this offer ends 11/30/04

Land Rover Farmington Hills  
 38200 Grand River Ave. Farmington Hills, MI 48335  
**(888) 834-8632**  
 See sales guide for details  
 Visit us online at [www.worldoferhard.com](http://www.worldoferhard.com)

**O'BRIEN SULLIVAN**  
 FUNERAL HOME

**Annual Holiday Memorial Program**

December 14, 2004 at 7:30 pm  
 Novi Civic Center  
 41575 W. Ten Mile, Novi

Refreshments Provided

Please RSVP to the O'Brien/Sullivan Funeral Home  
 248-348-1800  
 By December 13, 2004

**Oakland Community College** *Get ANYWHERE from here*

- University Transfer programs in Liberal Arts, Science, Business Administration
- Five convenient Campus sites in Auburn Hills, Farmington Hills, Royal Oak, Southfield and Waterford
- More than 130 Certificate and Degree programs in high-demand professions
- Affordable tuition—\$53.70 per credit hour for district residents
- Thousands of classes from which to choose
- Register on campus, online, or by phone
- No charge to apply

**Enroll NOW for Winter Classes NEW this Winter**

Touch\* Tone & Web Registration:  
 Extended - NOW thru Jan. 4

Final Registration:  
 January 5, 6 and 7

Classes begin:  
 Monday, January 10

Register for classes online:  
[www.oaklandcc.edu](http://www.oaklandcc.edu)

For information call: **248.341.2350**  
 Visit Our Website: [www.oaklandcc.edu](http://www.oaklandcc.edu)

**OAKLAND COMMUNITY COLLEGE**

Oakland Community College is an affirmative action equal opportunity institution

# FRINGE

FRIDAY

DECEMBER 10<sup>TH</sup>

In Downtown Northville

*All Aglow*

6:15 p.m. at the Gazebo

*Old Fashioned*

*Christmas Caroling*

Begins at 7:30 p.m.

*Late Night Shopping*

Shops Open until 11:00 p.m.

*Sweet Treats*

*Throughout Town!*

*See*

*Santa Claus!*



## Township Briefs

NORTHVILLE

# Parades usher in winter tax bills

### Parade performers

Instead of watching from the sidelines, two Northville students danced their way through last week's America's Thanksgiving Day Parade in Detroit last Thursday.

Julie Wesolowicz of Northville High School and Danielle Wesolowicz of Meads Mill Middle School donned classic red and white Santa's assistant costumes and entertained with eight fellow members of the Dance Electric Performing Arts Studio's Performing Company.

The company performed immediately before Santa and the Santa's Toyshop Float. They also appeared in The Parade Company Preview Show on Nov. 4, which aired Nov. 20 and 25.

Edison made the announcement Nov. 24 after a rate order from the Michigan Public Service Commission. Rates have decreased by 10 percent since the last increase was requested a decade ago, Edison reported.

The rate request was filed in June 2004, and the commission has requested Edison file another case in 120 days. The order addresses some of Edison's "serious cost issues" related to electric restructuring, increasing environmental compliance costs and other issues.

For more information, visit [www.dteenergy.com](http://www.dteenergy.com).

### Half-staff: how long?

Flags are flown at half-staff in Michigan when a soldier from the state dies in battle — and, of course, to commemorate certain national holidays and dignitaries.

But how long should flags be kept midway up the post when, say, a former president dies?

Braden Stradley of Holland, Mich. has launched U.S. Flag Alert, an e-mail alert letting people know the answer.

The service costs \$10 annually and is available to schools, hospitals, churches, libraries, businesses, private homes and others who display an American flag.

For more information, call (616) 395-3750 or visit [www.usflagalert.com](http://www.usflagalert.com), where information on flag history and etiquette also is available.

Have a news tip or story idea about a person, group or place in Northville Township? Contact Kim Kovellet at (248) 349-1700, ext. 107, or via e-mail at [kkovellet@ht.homecomm.net](mailto:kkovellet@ht.homecomm.net).

### Taxes: get in gear

Winter tax bills for 2004 were to be mailed out by yesterday, Dec. 1. Payment is due to the tax department, located in the new township hall at 44405 Six Mile Road, no later than 4:30 on Feb. 14, 2005.

If you missed the Sept. 14 deadline for 2004 summer tax bills, they too can be paid until Feb. 14 — with a 1 percent per month interest fee attached.

Postmarks are not accepted in either case. After the cut-off date and time, bills must be paid to the Wayne County treasurer.

### Electric costs frozen — for now

Detroit Edison said residential electric rates will remain at their current frozen levels until January 2006, when customers' costs will increase \$5.64 per month.

## Looking glass!



Photo by DAVID AGUILAR/RECORD EDITOR

Kim Behmer, owner of American Spoon in downtown Northville, stands at the doorstep of her Center Street store, voted last week by downtown visitors as the "best Holiday Window In Northville." Inside, Behmer displays some of the cherry-based gifts popular this holiday season.



## GUEST COLUMN

# Mill Race: discover Northville's historical 'hidden treasure'

By Joy Schartz  
GUEST COLUMNIST

Our family moved to Northville three and a half years ago, just in time to get our son in school. When the move was accomplished and the house in order I began to cast about for the interesting things to do and see in the town. Like any new resident I wanted to know the charming place we had chosen to live.

Originally from Savannah, Ga. where I had worked and volunteered for the Historic Savannah Foundation, one of my searches was for local historic sites. So I was delighted to discover the Mill Race Village located just northeast of downtown Northville on Griswold St.

Three years later I consider Mill Race Village as Northville's "hidden treasure." I say hidden because, if you are like me, the Main Street shopping area was more easily found and is, in itself, historically appealing.

But if you look just above the downtown, located on a lovely lake is a whole street of historic

buildings that have been saved, moved to the Village and restored. When you walk through the gates you are immediately taken back to another time. The buildings all greet you with a straightforward charm, yet each is unique in its intent and purpose.

I will not attempt to describe them for you as I cannot do justice to each one's significance in this short column. Suffice it to say that they are individually and collectively a remarkable piece of our 1800s heritage, brought together by the dream and efforts of people who refused to fail in their quest. One gentleman in particular has been the impetus for the preservation of these architectural gems and for the development of the Mill Race Village Site.

If I sound somewhat mysterious in my description it is with the hope that the mystery will lure you to see and hear for yourself. I promise you will be enchanted.

I will tell you that besides being a wonderful place to take your visitors, the Village offers its site for social functions, educational tours and a myriad of other event possibilities. Mill Race also sponsors

several public functions each year and is open to the public. A list of weekly events is published in the Northville Record. Coming up is one of the most popular events: The Children's Christmas Workshop, Dec. 4th.

Today the Village is supported by membership, donations, function proceeds and admissions. Multiply "This Old House" by

seven and you will have some idea of the funds required annually. Plus there's another "old house" waiting in the wings for restoration money.

I have become involved enough to hold a place on the Board of the Northville Historical Society, sometimes dubbed the "Hysterical Society" because of its preservation fervor. (In this case, thank

God for hysteria). The Village could not exist without the dedicated group that makes up the Historical Society. Becoming an outside-inner has made me appreciate the ongoing efforts of the staff, board and interested parties who are continually striving to maintain this piece of history for those who would come.

So, happily, you are invited to

venture one block north from Main St. on Griswold as I did. Discover the treasure that I found. The Village is there for you to experience a life and time gone by. For children and adults-new and long time residents, Mill Race is living history. And, after all, isn't history a vital part of our future?

For more information, call (248) 348-1845.

**CLUTTERED GARAGE?.....**  
**...CLOSETS OUT OF CONTROL?**

**BuildQuest LLC**

- Garage/Basement Storage Cabinets
- Custom Closet Systems
- Pantries/Laundry Rooms

**CALL FOR WINTER SPECIALS**  
— LICENSED & INSURED —

127 North Wixom Road  
Wixom, MI 48393

Ph. 248.345.1477  
Fax 248.960.4377

[www.simplifiedstorage.com](http://www.simplifiedstorage.com)

**VIOXX/BEXTRA** **NO FEE FOR FIRST VISIT**

Dr. Ryan A. Krebs, M.D., J.D.

have been linked to heart attacks and strokes as described in The Lancet, a respected medical journal. If you or a loved one have suffered a heart attack or stroke which may be linked to one of these drugs, call us for professional insight.

Doctor-Lawyer is Full-time Law Practice  
Timothy R. Cappolino, P.C.  
Board Certified Civil Trial Advocate by the National Board of Trial Advocacy  
MAIN OFFICE: Cameron, Texas

**1-800-460-0606**  
[www.thefractive.com](http://www.thefractive.com)

CAPPOLINO IS CERTIFIED AS ABOVE. OTHERS NOT CERTIFIED.

**SYNOPSIS AGENDA**  
**NOVEMBER 18, 2004 -**  
**REGULAR MEETING**  
**CHARTER TOWNSHIP OF NORTHVILLE**  
**BOARD OF TRUSTEES**

DATE: Thursday, November 18, 2004  
TIME: 6:30 p.m. Regular Meeting (Closed session 6:30 - 7:30)  
PLACE: 44405 Six Mile Road  
(SW corner of Sheldon and Six Mile Roads)  
TOWNSHIP HALL

CALL TO ORDER: Supervisor Abbo called the meeting to order at 6:30 p.m.

ROLL CALL: Mark Abbo, Supervisor, Sue Hillebrand, Clerk, Richard Henningsen, Treasurer, Marjorie Banner, Trustee, Marv Gans, Trustee, Shirley Kloukenga, Trustee, Brad Werner, Trustee

CLOSED MEETING: Stanej vs N'ville Twp, Biltmore Wineman vs N'ville Twp, Land Acquisition.

PLEDGE OF ALLEGIANCE:

1. Agendas: A. Approve Consent and Regular Agendas - approved with corrections
2. Appointments, Presentations, Resolutions & Announcements:
  - A. The Senior Alliance - approved additional payment
3. Public Hearing:
  - A. Pine Creek Estates 3rd Public Hearing - Street lighting
  - B. Pine Creek Estates SAD decision - approved
4. Brief Public Comments & Questions: Residents expressed concern re: rezoning of the NE corner of Sheldon and Five Mile Roads. Resident questioned Wayne County Road upkeep. Resident questioned the rezoning on Ridge and Six Mile Rd

**New Business:**

- A. Municipal Building Project - Progress Payments #20 & PD #7 - approved
- B. Municipal Building Project - Change Orders #30, #31 PD #7 & tech. #9 - approved
- C. Community Park - Change Order G - approved
- D. Community Park Progress Payment #6 - approved
- E. Liquor License transfer - Bon Fire Bistro - approved
- F. Papa Vino's LCC Request - approved
- G. Liquor License Request - denied
- H. Quail Ridge SAD - Paving Payment - approved
- I. Z.F. Technologies - Utility Easement - approved
- J. December 17th office closing - approved
- K. Saddle Ridge - Utility Easements - approved
- L. Community Park & DPS Entrance - Second Progress Payment - approved
- M. Rezoning request - denied
- N. Decision from closed session - Land Acquisition - none
- O. Decision from closed session - Litigation - none
- N. CWW dues - approved

6. Unfinished Business: None

7. Ordinances: None

8. Bills Payable: A. Bills payable in the amount of \$2,422,592.67 - approved

9. Board Communication: Reports from the following were given: Mark Abbo, Sue Hillebrand, Richard Henningsen, Chip Snider, Marv Gans, Marjorie Banner, Shirley Kloukenga, Brad Werner.

10. Any other business that may properly be brought before the Board of Trustees: Resolution Honoring Trustee Shirley Kloukenga

11. Adjournment: Meeting adjourned at 9:00 p.m.

MARK J. ABBO,  
SUPERVISOR  
SUE A. HILLEBRAND, CMC

(12-02-04 NR 181405)

**COMMUNITY FINANCIAL**

Thinking forward. Banking right.

**FREE CHECKING AT COMMUNITY FINANCIAL**

Serving your community for over 50 years, Community Financial gives you banking that's easier, friendlier and more rewarding than ever!

**Banking made easier with Free Checking**

- no minimum balance requirement
- no monthly maintenance fee
- unlimited check writing
- free Visa Check Card
- free Internet Banking with Bill Pay

To open your account visit your local office, give us a call or visit us on-line at [www.cfcu.org](http://www.cfcu.org).

(734) 453-1200 (877) 937-2328 toll free [www.cfcu.org](http://www.cfcu.org)

PLYMOUTH 500 S. Harvey CANTON 6355 N. Canton Center NORTHVILLE 400 E. Main NOVI 43350 Arena Dr

NCUA



## Northville Record

Part of HomeTown Communications Network™

David Aguilar  
EDITOR  
Grace Perry  
PUBLISHER  
Richard Brady  
VP/COO

Jack Lessenberry  
VP, EDITORIAL  
Dick Aginlan  
PRESIDENT  
Phillip Power  
CHAIRMAN OF THE BOARD

Our fundamental purposes are to enhance the lives of our readers, nurture the home towns we serve and contribute to the business success of our customers.

## Shuttle Time

Arrival yesterday of downtown Northville's shuttle bus should be welcomed news for retailers, employers and shoppers.

The shuttle will traverse downtown, picking up employees and shoppers alike six days per week, then returning them to cars parked a block or two removed from Main Street.

The pilot program is free until Jan. 3, when the price for a round-trip fare will be \$1.

We think the program is worth trying, but it should have two primary goals: first, it should mitigate downtown employee unrest, alleviating concerns by those now expected to walk an extra distance to downtown workplaces.

Second, program organizers

should work diligently to make the shuttle plan self-sustaining as quickly as possible.

If successful, the program has plenty of long-term marketing possibilities; if it fails, organizers are in no way obligated to continue it.

We applaud the efforts of City Manager Gary Word and Downtown Development Director Lori Ward for researching and implementing the plan on such short notice.

Will it work? Will employees long-term feel a buck is worth the handful of extra steps they are now being asked to walk? Who knows?

Rightly, the free market will determine the program's ultimate success. Either way, one message will resound: there are no free rides.

## Record Letters

### Thank you, Record

I would like to thank the Northville Record for the heart-warming story of Joelle Einem and her remarkable parents. I have been a pediatric nurse practitioner for 15 years and have often had the privilege of working with special families such as the Einem's. Your article goes a long way toward educating the community about youngsters with special needs. Indeed these young people laugh and cry, they feel joy and pain. They are members of families and communities. They enrich the lives of everyone who has the good fortune to take a moment and get to know them.

I have had my life touched not only by these special individuals, but also have been inspired by their families. It warms my heart that you have shared this story of hope and inspiration with our community as well. I also send a special "Thank you" to the Einem family for sharing their story. Thank you again for this beautiful piece.

Ann Marie Ramsey RN, NP  
C.S. Mott Children's Hospital  
University of Michigan Health System

sternation of Birminghamites who watched in alarm as many of the established homes in their neighborhoods were replaced with ostentatious, behemoth, "Bigfoot" palaces placed on postage-stamp-size lots. The concern was that the character of the town would be indelibly altered as newcomers with grandiose ideas about housing inexorably remade the town according to their lofty expectations. Added to this concern was the frustration that little could be done to curb such a trend, since Birmingham's city council was all too eager to embrace the increased property tax revenue that such oversized houses would generate.

Well, Bigfoot has found a new town to plunder: Northville. As my wife and I rounded the corner of Eaton and Thayer on a recent drive through town, she pointed out the imposing fortress of a mansion that has arisen on the tiny lot on the southeast corner of that intersection. As I looked up at an edifice that could well have served as a modest hospital in days gone by, I suddenly experienced a feeling of solidarity with the disillusioned, disgusted, established residents of Birmingham who railed not against progress, but over-the-top greed and excess.

Northville used to be a homogeneous community of quaint and unique, mostly turn-of-the (twentieth) century, Victorian homes. I applaud the wisdom that has put new homes incorporating the same period of architecture (and scale) onto our vacant lots and lots with razed 50s-era houses. But houses such as the monstrosity on the corner of Eaton and Thayer are so obviously out of synch with existing homesteads that they verge on the obscene.

I hear a lot of complaints regarding Our Lady of Victory's plans for expansion, and cries of "Save our Neighborhood", yet massive manor houses and chateaus will ultimately contribute far more to the ruination of this small town's small town appeal than any new (and badly needed) school addition to OLV. At the same time that the Bigfoot trend is welcomed by some for the increase in property values it brings, our town is selling out with regard to its authentic connection with and representation of the past. Is this truly what we want?

Kenneth E. Kilpatrick  
Northville

### Much thanks

Thank you to everyone who supported and attended the Don Fee Memorial Benefit at Genitti's on Nov. 11. A special thank to the Genitti family and staff. Your hard work and generosity meant so much to our family. It was a wonderful evening that we will never forget.

The Albright family  
Milford

## Some Lions do entertain their fans!



PHOTO BY JOHN HEIDER/NORTHVILLE RECORD

Silver Springs Elementary School students recently enjoyed the Traveling Lantern Theater's presentation of "The Lion, the Witch, and the Wardrobe."

## Michigan needs to allow wine into state

You don't have to be a dyed-in-the-wool conservative to recognize that there are far too many instances of the "nanny state," where governments presume that they alone know best how to take care of people and that there is no real or imagined problem that cannot be overcome by continued and oppressive regulation.

Examples abound, including that tag on your mattress cover that forbids its removal "under penalty of law" and state restrictions on processing (why not "butchering," for Heaven's sake?) venison.

Another example has to do with the spider web of regulations covering the shipping, warehousing and selling of wine, beer and booze. When Prohibition (itself a first class example of failed state nanny-ism) ended in 1933 with the adoption of the 21st Amendment, many states lost no time in combining a bow to temperance advocates with a grab for state profit by enacting elaborate regulations on the sale of alcohol.

Michigan, it turns out, is one of 11 states that forbid out-of-state wineries from sending bottles directly to customers. This rule, which restricts consumer choice and protects the economic turf of members of the Michigan Beer and Wine Wholesalers Association (the single most powerful lobby in Lansing), is now being challenged at the highest level. Oral arguments before the United States Supreme Court will be held next Tuesday.

Advocates for change argue that the Constitution, through the Interstate Commerce Clause, gives the federal government — not the states — the right to regulate interstate trade in wine or anything else. Defendants (including Michigan Attorney General Mike Cox, who should know better) assert that the 21st Amendment gives states the right to regulate everything about the

sale of alcohol. This argument over states' rights has been simmering quietly for a long time, but the rise of the Internet as a shopping medium and the increasing numbers of new, boutique wineries have brought the issue to a head.

The moving forces behind all this are a couple, Ray and Eleanor Heald, who have been writing a column on wine and spirits for the Observer & Eccentric Newspapers since 1990. Four years ago, the Healds heard about the Domaine Alfred winery in California; they contacted Terry Speizer, the winemaker. They asked if he could send them a bottle of pinot noir to evaluate for their column. No, he replied, because Michigan law won't allow out-of-state wineries to send even one measly bottle into the state. Moreover, he couldn't sell his product here because wine distributors in Michigan couldn't be bothered with stocking wines from such a small winery. So the Healds and Speizer sued.

There's little doubt that overturning the restrictive state laws that now exist in almost half our nation would benefit both consumers and small wineries. In all, 11 states have passed laws favoring in-state wineries and another 13 forbid outright all direct wine shipment. The Federal Trade Commission found in 2003 that direct shipping and online wine sales would "significantly enhance consumer welfare." One reason is price; the FTC found that buying wine online is cheaper than at local stores. Another benefit is choice; there are 3,700 wineries in the U.S., but most of them are too small for traditional wholesalers and distributors to bother with. The Wine Institute, a group arguing for regulation change, says only 13 percent of California's 800 wineries have distribution in all 50 states.

For example, consider Tantalus, a small

ultra-premium winery in Sonoma County, California. I met Jim Harwood, Tantalus' president, last summer when I sampled his syrah wine and found it excellent. "Can I get some?" I asked. "Nope, unless you actually visit the winery in person, in which case Michigan law allows me to ship you one case."

"My output is only 3,500 cases, which is pretty small," explained Harwood, who married a woman from Michigan in 1978 and found his hobby turning into a fully permitted family business in 1989.

"Over the years, I've had three distributors in Michigan, but all of them found my wines uneconomic to stock. Even a winery with a 50,000 case production is on the borderline. There are plenty of people in Michigan who would love to buy my wine, but they can't get it because of the law. And there are so many differing laws in the different states; shipping wine to Kentucky, for example, is a felony."

When asked, advocates for the present system like to throw up moralistic rhetoric about "curtailing underage drinking." Sure! Some kid is going to go on the web and pay 40 bucks a bottle for an ultra-premium wine? A 2004 study by the National Academy of Sciences found that parties, friends and strangers are the most likely ways for kids to get booze, a finding that matches the experience of most parents. (They don't normally get in trouble with premium wines, either.)

I admire the Healds (who write a pretty darn good wine column) for their professionalism and their willingness to take on the nanny state in its lair. I hope the Supreme listen with care next Tuesday. A decision is expected some time next summer.

Ray and Eleanor Heald write a wine column for the Observer & Eccentric Newspapers, a sister company to HomeTown Newspapers.

Phil Power is the Chairman of the Board of the company that owns this newspaper. He would be pleased to get your reactions to this column either at (734) 953-2047 or at ppower@homecomm.net.

## Nothing new about players going after fans

Okay. The entire state — make that, the whole nation — is loudly indignant over the famous "basketbrawl" incident in which players from the Indiana Pacers, all of whom make more money than God, climbed into the stands to beat up fans during a game against the Detroit Pistons.

Matter of fact, you would think from the outraged reaction of the "chattering class" that this incident was slightly more significant than the recent presidential election. Well, let's not go there. But there are two other things being said that just aren't true. First of all, this had nothing to do with Detroit.

That's right. Whatever may be wrong with Detroiters, they are, by and large, poor. Few can afford tickets to Pistons games. Even if they could, many don't have cars, and would have a hard time getting there. The Detroit Pistons play, not in Detroit, but in Auburn Hills, a middle-class suburb 40 miles away.

Most or all the fans involved in the melee were prosperous white suburbanites. Matter of fact, the one who allegedly started it all by throwing something at Ron "Mad Dog" Artest was recognized by one of his former neighbors who was watching videotaped replays of the mayhem. Too bad for him the neighbor is now the Oakland County prosecutor.

Anyway. Time to debunk the second big falsehood. There's nothing new about players going after fans. Unusual, yes. Original, no.

Not only is this not the end of life as we know it, it has happened before.

That's right, and what's more, it also

involved Detroit. A player attacked a fan — a crippled fan, yet — and vaulted into the stands and beat him up.

The outraged authorities suspended the athlete — and his entire team went on strike in solidarity. Don't know the story? That's perhaps because it was nearly a century ago. The date was May 15, 1912, and the player was good old Ty Cobb, sometimes known as the sociopath of the base paths.

Ty Cobb was not a nice man. He liked to spike people. He beat up his own teammates, and once nearly killed a black man with his fists just because he felt like it. But on that spring afternoon, he met someone as wonderful as he was.

Claude Lueker spent four innings calling him everything except a child of God. Finally, Cobb hopped the fence and whaled the tar out of him. Sportsmanlike, this was not. Lueker had only one arm, and was missing most of the fingers on that hand.

Ban Johnson, the president of the American League, was as horrified as NBA officials seem to be today. He suspended the Georgia Peach indefinitely for "acting without regard to the dignity of baseball."

That outraged his fellow Detroit Tigers, who promptly went on strike. The American League told the manager and the owner of the team they would be fined heavily if the team didn't play. Frank Navin, the owner told the manager, Hughie Jennings, to find some players before the next game, or else.

The manager could take a hint. He found some college players. He made two middle-aged scouts play, and he picked a few guys

out of the stands.

They lost to Philadelphia, 24-2. Sports historians are still wondering how the ersatz Tigers got the two runs. Everyone was horrified; the American League then banned replacement players and teams, and the Tigers returned to play.

Then the league folded, and Ty Cobb (no Ron Artest, he) was allowed to return to the field. He went on to bat .410. The Tigers finished the season about as poorly as they did this year, and nobody knows what happened to the foul-mouthed heckler who was beaten up by baseball's greatest hitter.

What's the moral of the story? Perhaps that even if you think moral values are eroding, testosterone always has been with us. And in general, people who make \$5 million a year risk a lot if they get into fist fights with your average slob.

And vice-versa.

Profile In Courage: Last summer I wrote about Ron Kagan, the Detroit Zoo director who had decided that Detroit had neither space nor climate to properly maintain the zoo's two aging elephants, and so he planned to send them to a wildlife sanctuary. But now the American Zoological Association opposes that, and wants the elephants sent to the Columbus Zoo instead.

Dr. Kagan doesn't think Wanda and Winky would be any better off there, and things are at an impasse. Another complication: Wanda is technically owned by San Antonio's Zoo, and it won't sell her to Detroit. Though it may risk the zoo's accreditation, Dr. Kagan vows to keep fighting for what's right for the elephants.

Jack Lessenberry is editorial vice president of HomeTown Communications. He can be reached by phone at (248) 901-2561 or by e-mail at jlessenberry@homecomm.net.



Phil Power  
CHAIRMAN,  
HOMETOWN COMMUNICATIONS



Jack Lessenberry  
EDITORIAL VICE PRESIDENT,  
HOMETOWN COMMUNICATIONS

## Greed is growing

A few years ago, I recall the con-



### Share your opinions:

We welcome your letters to the editor. Please include your name, address and phone number for verification. We ask that your letters be 400 words or less. We may edit for clarity, space and content. Generally, no more than one letter per month by the same author will be published.

**Elections:** In order to be fair to everyone, this newspaper will not run letters to the editor the week prior to an election that open new issues. Expressions of thanks to political supporters are best made by buying an advertisement.

**Mail:** Letters to the Editor, David Aguilar, Northville Record, 104 W. Main St., Northville, MI 48167.

**Fax:** (248) 349-9832

**E-mail:** aguilard@homecomm.net

# COMMENTARY

Northville Record

## Daily bread

At First United Methodist Church, Thanksgiving Day was about passing slices of life, hope and faith

**O**ne young mom had to be convinced she should partake in a free Thanksgiving Dinner last Thursday.

No strings, volunteers told her: You and your son can share the holiday. Companionship, plus turkey and the rest of the trimmings.

The mom relented, attended and learned a whole new lesson in gratitude. Her son charmed the servers. She talked to Civic Concern's Marlene Kunz about how to try to turn around her life circumstances.

First United Methodist Church set the festive scene for the holiday that otherwise could have been a blunt day-like-any-other blow for some of our nearby neighbors.

Instead, 110 parishioners and locally-affiliated volunteers took on the first-time-ever task of preparing a feast for 200 in the fellowship hall at Eight Mile and Taft roads.

"Nobody seems to have done this around here," said Jim Henson, a 16-year congregation member, who sits on the church's outreach committee. Since September, he led the effort to provide Thanksgiving dinner for men, women and children recognized by local agencies, churches, Allen Terrace and acquaintances as likely unable to observe the annual holiday tradition.

"It's the one time we set aside for friends and family to be together," Henson said. "I said, 'Eat with us. Eat with family.'"

Church donations covered a dozen 20-plus-pound turkeys, dressing, cranberry sauce, rolls, cornbread, green beans, yams, lots of desserts.

Even more generously, parishioners contributed time. Henson said he ended up turning away volunteers. "Assignments complete: 'too many cooks,' so the saying goes.

The kitchen Thursday morning was a well-thrived — actually squeaky clean — operation. While the holiday workers tended to trays and pans in the oven, put finishing touches on harvest-theme tables with angel centerpieces, poured beverages and waited to meet their guests, they talked about what the holiday means to them.

Some of the volunteers planned to see the dinner through; some of the early-morning crew headed off to celebrations with family and friends elsewhere. It was relationships they spoke of with the most gratitude.

"My daughter (Emily) is home from college," said Len Dixon as he crushed boxes for recycling. "As far as I know, my son (Rob) is safe in Afghanistan. He called a couple of days ago. He's cold, but he's fine."

Myriam Menke, who previously volunteered on Thanksgiving at other churches, said serving reminded her of the true meaning of the holiday.

"We're doing things for other people, not ourselves," she said. "We're all together doing something that God has taught us to do. And to have fun."

"I like to talk to the people," Menke said. "Sometimes just one word you can say to the person can make the difference. You can see it in their reaction."

"To me, they give me the happiness."



ABOVE: Linda Kyle, Robb Stevenson and Roger Kyle, of Northville, joined Myriam Menke, of Novi, serving Thanksgiving dinner last Thursday morning at First United Methodist Church.



Maureen Johnston  
RECORD STAFF WRITER

RIGHT: Kristen Singletary, 13, of Northville Township, volunteered during last week's feast.

BELOW: Linda Kyle and Toni Genitti watch Roger Cotting prepare green beans.

BOTTOM RIGHT: Toni Genitti reads bread baskets and desserts.



Photos by DAVID AGUILAR/Northville Record Editor



### CATCHING THE HOLIDAY SPIRIT

Want to catch that holiday spirit? Local families still need their neighbors' support.

Here's some suggestions how to contribute:

- **Northville Civic Concern:** Marlene Kunz (248) 344-1033, Highland Lakes Shopping Plaza
- **Non-perishable food items, household paper products, personal toiletries, gas cards, Meijer or Target gift certificates**
- **Church of the Holy Family in Novi:** Carol Ann Donnelly (248) 349-8847, 24505 Meadowbrook Rd.
- **Gently used clothing, household items**
- **Edward Jones Investment:** local offices are collecting new blankets and are supporting the American Red Cross Blanket Days program. Northville offices are 117 E. Dunlap, 128 No. Center St. and 1039 Novi Rd.
- **Novi Bowl, 21700 Novi Rd.:** selling snowflakes to raise cash for Northville Civic Concern.

They also are collecting gift cards, toys and clothing through Dec. 31 for the local agency, Manager Tari Rutkowski said. For more information, call (248) 348-9120.

"It would nice if we could fill a semi or the bowling center," she said. "If I have to fill every nook and cranny, that's fine."

In our own small way, the Northville Record staff is joining in... Each time you see us wearing jeans or a sweatshirt during business hours around town, that means we contributed to the cause that day.

### Annual fundraising auction tomorrow

An autographed University of Michigan football, romantic weekend packages and high-tech gadgets are among hundreds of items to be auctioned Friday night.

The Nativity of the Virgin Mary Greek Orthodox Church starting at 6:30 p.m. is hosting its 13th annual fundraiser Dec. 3 at the fellowship hall, 39851 W. Five Mile Rd., near Haggerty Road. Church members will be serving fried fish as well as a variety of desserts, including Greek pastries.

The annual silent and live auction is the 300-member church's method to fund operations, said event organizer Jim Kosta. They expect 400-500 people to attend.

### GUEST COLUMN

## Community service, in lieu of suspension?



Mary Ellen King  
NORTHVILLE  
YOUTH ASSISTANCE

For years I questioned why students who did something "wrong" at school were sent home. Most of these students were happy to be able to go home and probably watch television or sleep.

My idea was to have students participate in community service work instead of being sent home. I presented this idea to the Northville Youth Assistance Commission who wholeheartedly approved

of the idea. I then got the schools on board and the program was launched.

The program began in 1999 with placing high school students in community service sites. To date, approximately 200 students have participated in the program. These students have learned what it means to give back to their community. They have done such things as working in the kitchen of an assisted living residence. They have played bingo with nursing home residents. They have worked at parks and recreation special events such as Northville Nite and the Pumpkin Walk.

A few years later, we began the program at the middle schools.

This program has a little different twist. The students work on a Saturday morning for two hours. Their parents have to stay for that time, and Sue Campbell of the NYA staff supervises them. These kids can see the

efforts of their labor. When they walk down their school halls and see cleaner walls, they will know that their service work meant something. They will learn the importance of not littering when they clean up the trash after a Friday night football game.

Hopefully they will be more inclined to keep their community clean.

Hillside Assistant Principal Laura Kelly-Porzio says, "Community service in lieu of suspension is such a valuable option for the schools and parents, we would definitely like to see it continue for years to come."

What started out as an idea and then a pilot program is now an integral part of the high school and middle school. If you have any questions, please feel free to call Mary Ellen King at (248) 344-1618 or send an e-mail to youthassistance@northvillemich.com.

<b>ST. PAUL'S LUTHERAN MISSOURI SYNOD</b> High & Elm Streets, Northville T. Ludwick, Pastor Church 349-3140 • School 349-3146 Sunday Worship: 8:30 a.m. & 11:30 a.m. Contemporary Services at 11:00 a.m. Sunday School & Bible Classes 9:45 a.m. www.stpaulsnorthville.org	<b>FIRST PRESBYTERIAN CHURCH OF NORTHVILLE</b> 200 E. Main St. of Hutton • (248) 349-0911 Worship & Church School - 10:00am Children Available at All Services Youth Logic Prog. Wed. 4:15-5:00 M.S./H Singles Place Ministry - Thurs. 7:30pm Rev. W. Kent Cisa, Senior Pastor Rev. James R. Reser, Associate Pastor
<b>NORTHVILLE CHRISTIAN ASSEMBLY</b> 4155 Seville Road • Northville 248-348-9000 Adult Youth & Children's Care Ministries 9:00-9:30 AM Sunday Celebration Service 10:00 AM Children in Sanctuary for Peace & Worship Children's SuperChurch 10:30 AM Wednesday Family Night 7:00 PM to 8:45 PM Pastor Dale Buchanan, Sr. Pastor www.northvillechristian.org	<b>OUR LADY OF VICTORY CATHOLIC CHURCH</b> 770 Thayer, Northville WEEKEND LITURGIES: Saturday 5:00 p.m. Sunday 7:30, 9 AM, 11 AM, 12:30 PM Church 349-2621, School 349-3610 Religious Education 349-2559 Rev. Terrence Kernick, Pastor
<b>MEADOWBROOK CONGREGATIONAL CHURCH</b> 21355 Meadowbrook R. Novi at 8 1/2 Mile Morning Worship 10 a.m. Sunday School & Nursery 10 a.m. 248-348-7757	<b>GOOD SHEPHERD LUTHERAN CHURCH</b> 9 Mile & Meadowbrook Wisconsin Ev Lutheran Synod Sunday School and Adult Bible Class 8:45am Worship 10:00am Thomas E. Schroeder, Pastor - 349-0665
<b>CHURCH OF THE HOLY CROSS EPISCOPAL (Anglican)</b> 10 Mile between Taft & Beck, Novi Phone 349-1175 Sun. 7:45 & 10:00 am Holy Eucharist Sunday School & Nursery 10 am Rev. Karen Henry, Pastor www.churchoftheholycross.com	<b>FIRST UNITED METHODIST CHURCH OF NORTHVILLE</b> 349-1144 8 Mile & Taft Roads Worship Services 8:00am, 9:15am & 11am Rev. John Hice Rev. Lisa Cook
<b>FAITH COMMUNITY PRESBYTERIAN CHURCH</b> 44400 W. 10 Mile, Novi 248-349-2345 1/2 mile west of Novi Rd. Dr. Richard J. Henderson, Pastor Worship & Church School 9 & 10:30 am Sunday	<b>FIRST CHURCH OF THE NAZARENE</b> on Haggerty Rd. North of 8 Mile Rd Sunday School 9:30 a.m. Morning Celebration 10:50 a.m. (248) 348-7600 Dr. Ron Blake, Pastor
<b>ST. JAMES ROMAN CATHOLIC CHURCH NOVI</b> 46325 10 Mile Rd Novi, MI 48374 Saturday 5:00 p.m. Sunday 8:30 & 11:30 a.m. Reverend George Chomley, Pastor Parish Office 347-7778	<b>BETHLEHEM EPISCOPAL LUTHERAN CHURCH, ELCA</b> "Let us go now to Bethlehem and see the thing that has taken place." - Luke 2:15 35300 W. 8 Mile Farmington Hills MI (248) 478-6520 (2 mi E. of Haggerty, N. side of 8 Mile) Sunday Morning Worship 8:30 & 10:45 AM Sunday School (All Ages) 9:30 AM
<b>CHURCH OF THE HOLY FAMILY</b> 24505 Meadowbrook Rd., Novi, MI 48375 Masses, Sat 5 pm; Sun 7:30 a.m., 8:45 am, 10:30 am, 12:15 pm Holy Days, 9 am, 5:30 pm, 7:30 pm Fr. John G. Budda, Pastor Fr. Paul Bollen, Associate Pastor Parish Office 349-8847	<b>WARD EVANGELICAL PRESBYTERIAN CHURCH</b> Dr. James H. McGuire, Senior Pastor 47000 Seville Road, Northville, MI 248-374-7422 Traditional Services 8:00, 10:15, 11:30 a.m. Contemporary Services 9:00 a.m. Sunday School & Nursery Provided Sunday Evening Service 7:00 p.m. Seville Road, at W. 27 1/2 Mile, 20 a.m.
<b>Your Church Could Be Here!</b>	<b>MEADOWBROOK CONGREGATIONAL CHURCH</b> 21355 Meadowbrook R. Novi at 8 1/2 Mile Morning Worship 10 a.m. Sunday School & Nursery 10 a.m. 248-348-7757 Minister Rev. Dr. E. Neil Hunt Minister of Music: Patrick Kuhl
<b>ST. JAMES ROMAN CATHOLIC CHURCH NOVI</b> 46325 10 Mile Rd Novi, MI 48374 Saturday 5:00 p.m. Sunday 8:30 & 11:30 a.m. Reverend George Chomley, Pastor Parish Office 347-7778	<b>CROSSPOINTE MEADOWS CHURCH</b> Pastor Danny L. Langley Traditional Service - 9:00 A.M. Contemporary Service - 10:30 A.M. Meeting at Novi Civic Center 248-444-7755 crosspointemeadows.org

### CHURCH DIRECTORY

For information regarding rates call  
The Northville Record or Novi News (248) 349-1700



# WHAT'S GOING ON?

Northville Record

## NORTHVILLE'S OFFICIAL EVENTS CALENDAR

— To submit information about local events to 'What's Going On?' please e-mail to nrevents@ht.homecomm.net. —

### Local Events

#### Daughters of the American Revolution

The Daughters of the American Revolution, Sarah Ann Cochran Chapter of Plymouth-Northville are hosting a Christmas Tea on Monday, Dec. 20, 2004 at 1 p.m. This will be at Greenmead, Hill House, Livonia with Sue Daniel as the speaker.

#### Marquis Theatre Presents

This holiday season enjoy a musical adaptation of "Rumpelstiltskin" at Northville's historic Marquis Theatre, through Jan. 16, 2005. Performance times and dates are: Saturday at 2:30 p.m., Dec. 4, 11, 18 and Jan. 8, 15, 2005; Sundays at 2:30 p.m., Dec. 5, 12, 19, 26 and Jan. 2, 9, 16, 2005; Weekdays, Monday through Friday at 2:30 p.m., Dec. 27, 28, 29, 30 and 31. Tickets to all performances are \$7.50. Please no children under the age of three. The Marquis Theatre is located at 135 E. Main St. For more information, call (248) 349-8110.

#### Genitti's Dinner Theater

Opening Dec. 2; "Cowpoke Holiday". Cost is \$45 per person for dinner and show. Call for reservations, (248) 349-0522 or genittis.com. Genitti's is located in downtown Northville at 108 E. Main St.

#### All A-Glow/Illumination for Education

Sponsored by the Mother's Club will take place Dec. 10. For more information, please call (248) 349-6364.

#### Candlelight Walk

Sponsored by the Northville Central Business Association will take place Dec. 10. For

more information, please call (248) 349-0611.

#### Babes in Toyland-Northville Youth Theatre

This holiday classic will run at the Senior Community Center on Dec. 17, 18 and 19. Tickets go on sale Aug. 18. Presented by Northville Parks and Recreation and Serendipity Productions.

#### Holiday Open House

The annual Holiday Open House of the Northville Mothers' Club Life Members will have a change of atmosphere this year. The group will showcase the newly renovated Senior Community Center for the fundraising event on Saturday, Dec. 4 from 5-7 p.m. Higher education grants-in-aid will be awarded with the proceeds of the event. Four \$1000 scholarships were presented to Northville High School seniors last June. The Senior Community Center will bring all guests together in a single location to rekindle old friendships and spark new ones while celebrating the Winter Holiday Season. For additional information, or to be added to the invitation list, please contact Marge Longridge, President, at (248) 349-0551. Suggested contributions are \$17.50 per person, which include food and beverages provided by the Life Members.

#### Little Elves Workshop

Make three cool gifts in this sparkly holiday workshop. Kids will build and paint a wood toy, create an awesome stained glass goblet and decorate some holiday (or year-round) sun catchers. Then they can give them away as gifts or keep them as early holiday treats! Parents this is a good opportunity to do some Christmas shopping, or just relax for a quiet Saturday morning without the kids. A \$6 supply fee is due to the instructor at

the workshop (cash only please). For ages 6-12 at the Art House, Mosaic, Saturday, Dec. 11 from 10 a.m.-12 p.m. The cost is \$22, \$27 and \$32.

#### Children's Workshop

Bring the family to Mill Race Village for a fun Christmas workshop, Saturday, Dec. 4, 10 a.m.-12 p.m. and 1-3 p.m. Registration for the Children's Christmas Workshop began on Nov. 5. For more information, please call the Northville Historical Society at (248) 348-1845.

#### Jingle Bell Run for Arthritis

Imagine the sounds of hundreds of thousands of bells jingling as people from coast to coast run, walk and cheer in the Arthritis Foundation's Jingle Bell Run for Arthritis. Across the country, bells will be ringing as people like you tie jingle bells to their shoelaces, don festive holiday costumes and join friends and neighbors in support of the Arthritis Foundation's mission to prevent, control, and cure arthritis and related diseases. Choose from a 5K run or 5K run walk. The Jingle Bell Run for Arthritis raises awareness of America's leading cause of disability, while raising desperately needed funds for research, public health and policy efforts to improve the lives of people with arthritis. At Northville Downs, 301 S. Center St. (corner of Sheldon and 7 Mile roads), on Dec. 5. Registration begins at 7:30 a.m. For more information, or to register go to www.arthritis.org.

#### Grief and the Holidays

Ward Presbyterian Church is sponsoring a holiday workshop for those who are grieving. All adults who have experienced the loss of a loved one are welcome and encouraged to attend this free workshop presented by Cathy Clough, Director of New Hope Center for Grief Support. The workshop will be held on Monday, Dec. 6 from 7-8:30 p.m. at Ward Church located at 40000 Six Mile Road in Northville. The workshop will end with a special time of remembrance. There is no need to register, but for further information call Dorothy at (248) 374-5966.

#### Girls Night Out

Join us on Thursday Dec. 2, from 5-8 p.m. for wine, hors d'oeuvres and great holiday specials. At Van Dam's, 111 E. Main St. in Northville. For more information, call (248) 449-4282.

#### Author Anne Margaret Lewis

Barnes and Noble welcomes Anne Margaret Lewis, Saturday, Dec. 4, at 11 a.m. in Northville. She will be signing her book "Tears of My Mother Bear" in the store at 17111 Haggerty Road, Northville. For more information, please contact the store at (248) 348-0696.

#### Story Time with Rachael Hunter

As part of Barnes of Noble's Holiday Book Drive, Barnes and Noble in Northville will be having a special kick off story time featuring Rachael Hunter, co-host of "Jay and Rachael in the Morning" 93.1 WDRQ. She will

be reading The Polar Express on Tuesday, Dec. 7, at 7:30 p.m. For more information, contact the store at (248) 348-0696.

#### Mitch Albom

Newspaper columnist and broadcaster Mitch Albom will be appearing at the Barnes and Noble in Northville to sign copies of his latest book "The Five People You Meet in Heaven," on Saturday, Dec. 11, at 2 p.m. For more information, contact the store at (248) 348-0696.

#### Award winning photographer Monte Nagler

He will be at Barnes and Noble on Saturday, Dec. 11, at 1 p.m. in Northville, signing copies of his 2005 calendar, "American Perspectives: Views of America." For more information, please contact the store at (248) 348-0696.

#### Jeff Daniels

Famed actor and musician, will be signing copies of his new CD; "Jeff Daniels: Live and Unplugged" at Barnes and Noble in Northville on Saturday, Dec. 18, at 7 p.m. All proceeds from the sale of his CD will go to benefit The Purple Rose Theater in Chelsea. Mr. Daniels will be happy to sign other material with the purchase of his

CD. For more information, please contact the store at (248) 348-0696.

### Seniors

#### Senior Calendar

Thursday Dec. 2  
9 a.m. Massage Therapy  
10 a.m. Pinochle  
Friday Dec. 3  
12 p.m. Euchre  
1 p.m. Movie  
Monday Dec. 6  
10 a.m. Blood Pressure Check  
12:30 p.m. Pinochle  
1 p.m. Line Dancing  
Tuesday Dec. 7  
9:30 a.m. Meijers  
11:30 Lunch  
12:30 Pinochle  
1 p.m. Movie  
Wednesday Dec. 8  
9 a.m. Foot Reflexology  
9:30 a.m. Westland Mall  
11 a.m. Red Hat Club  
Christmas Party  
12 p.m. Bridge

### Library Lines

The Northville District Library is open 10 a.m.-9 p.m. Monday through Thursday, 10 a.m.-5 p.m. Friday and Saturday and is closed on Sundays for the summer. The library is located at 212 W. Cady St., near Northville

continued on page 19A

When was the last time your dealer offered to pay for your maintenance?



Enter The World Of Erhard 2005 325i \$299/mo

Erhard BMW Of Bloomfield Hills 4065 Maple Road 888-273-9711 Mon & Thurs 9-9 • Tues, Wed, & Fri 9-6 • Sat 10-4

SPOTLIGHT ON: ALLERGY & ASTHMA Presented by Michael S. Rowe, M.D., F.A.C.P., C.C.R.I. SEVERE FLU CASES EXPECTED CENTER OF MICHIGAN within 48 hours of the first symptoms. We may be able to provide an anti-flu treatment to shorten or prevent the illness. We can be reached at (248) 473-6400 and we are located at 24120 Meadowbrook Road, Ste. 201 in Novi. New patients are welcome. "The Caring Allergist Who Gets Results."

Dilute Your Debt! With Resource Lynx the top lending institution in North America with the perfect resources to help you be financially free. Resource Lynx guarantees service perfection in all financial needs!

ESTW002ES Bid Package Templates Rev 9 Advertisement for Bids NORTHVILLE PUBLIC SCHOOLS Meads Mill Middle School BID PACKAGE FOR EARTHWORK & SITE UTILITIES

IVF-Michigan Recognized Leaders in the Treatment of Infertility Presents a Free Patient Seminar Experiencing Infertility? Learn more about your options from the experts right here at home.

IVF Michigan PC Recognized Leaders in the Treatment of Infertility www.Midwestivf.com

ACAPULCO HOT Days & Sizzling Nights! An ideal climate with almost guaranteed sunshine beckons travelers to Acapulco's sprawling shores where watersports abound, romance flourishes and the party never ends. Forever Acapulco!

Manufacturer's Warehouse Sale Brand Name Items In Original Packaging ALL NEW ITEMS GREAT BARGAINS ON: Pistol Cases, Gun Cases, Riflescopes, Binoculars, Luggage, Photo Albums, Laptop Cases, Brief Cases



## WHAT'S GOING ON? (CONT'D)

continued from page 18A

city hall, with parking off Cady Street. For information about programs, services, or to request or renew library materials, call (248) 349-3020.

### Library Board Meetings

The Northville District Library Board of Trustees typically meets at 7:30 p.m. on the fourth Thursday of the month. The public is welcome to attend.

### Holiday Crafts for Kids

Children of all ages are invited to make a fun holiday card, a paper bag reindeer puppet and a gingerbread man magnet on Thursday, Dec. 16 at 4 p.m. Children younger than age 5 must be accompanied by a caregiver. No registration required for this free one-hour program.

### Little Me Storytime for Little Ones

Little ones, from 10 months to 2 years, along with parents and caregivers can enjoy music, beanbag fun and simple stories, Friday, Dec. 10 from 10:30-11:15 a.m. This special activity offered each month, and no registration is required. Infants and older children are also welcome to attend.

### Evening Family Storytime

Kids, wear your pajamas and enjoy a lively storytime! This half-hour program is best suited for children 3 and older, but all ages are welcome. Just drop in and enjoy on Wednesday, Dec. 15 at 7 p.m.

### Between the Lines

Join us on Dec. 13 at 7 p.m. for a discussion of the best-selling novel "The DaVinci Code" by Dan Brown. This evening book group meets the second Monday of each month, and all are welcome.

## Mill Race Historical Village

### Children's Christmas

Registration for the Children's Christmas Workshop began on Nov. 5. The Children's Christmas Workshop will take place at Mill Race Village on Dec. 4 from 10 a.m.-12 p.m. and 1-3 p.m. For more information, please call the Northville Historical Society at (248) 348-1845.

### Mill Race

Having family in town for the holidays? Think about scheduling a Private Tour of the village during the month of Dec. while the buildings are decorated for the holiday season. Private Tours are approximately an hour to an hour and a half, and are \$3 a person (minimum of \$30). All proceeds go to maintaining the village.

Thursday, Dec. 2: Brownie Scouts (4:30 p.m.), Cub Scouts (6:45 p.m.)

Friday, Dec. 3: Brownie Scouts (3:45 p.m.)

Saturday, Dec. 4: Children's Christmas Workshop (10 a.m.-3 p.m.)

Sunday, Dec. 5: Mill Creek (10 a.m.), Holiday Tea (10 a.m.)

Monday, Dec. 6: Junior Scouts (3:45 p.m.), Brownie Scouts (4:30 p.m.), Cub Scouts (6:15 p.m.)

Tuesday, Dec. 7: Stone Gang (9 a.m.), Daisy Scouts (4 p.m.), Brownie Scouts (6 p.m.)

Wednesday, Dec. 8: Brownie Scouts (3:45 p.m.), Mill Creek (7 p.m.)

Thursday, Dec. 9: SUM Unit A Scouts (9:45 a.m.), Mill Race Questers (6:30 p.m.)

\*Grounds closed to Public

## Looking for You

### Bell Ringing Persons Needed

The Salvation Army Red Kettle bell-ringing season began Nov. 22 in Northville and continues until Christmas Eve. Four locations are available: Hiller's on Center Street, the Northville Post Office, Great Harvest Bread Co. and Farmer Jack on Haggerty. We need bell ringers for these locations. Groups or individuals are welcome. Call Judy Kohl (248) 348-2678 to sign up. Donations are always appreciated. Checks should be made out to Plymouth Salvation Army.

### An Elegant Holiday Tea

Ladies, invite your closest friends to a charming little tea to celebrate the holiday season and host one of our tables in the elegant banquet room at the newly renovated Senior Community Center. This tea is sure to be a welcome festive occasion and in time a favorite holiday tradition. Join the fun Thursday, Dec. 16 from 11 a.m.-1 p.m. Cost is \$65 per table of eight.

### American Spoon

Every Saturday in December American Spoon will be demonstrating how to use select store products. American Spoon is located at 105 N. Center St. Hours are 10 a.m.-6 p.m.

### Personalized Letter from Santa

Give a gift that will last for only \$5.99. A personalized letter straight from Santa on high quality paper. Letter comes personalized with child's name, city and state. For more information, please e-mail sales@upzones.com

## Parks and Recreation

### Northville Sweatshirts

Northville Ski and Snowboard Club hooded sweatshirts are on sale now. Sweatshirts are \$40 each and must be picked up at time of purchase. These make great Holiday gifts. Get yours today at the Recreation Office.

### Announcing the all-new Junior Ski and Snowboard Club

Skiers and snowboarders in the 4th and 5th grades are invited to join this club and find out what the buzz is all about! Parents are welcome to attend as chaperones. Weather permitting we will take two afternoon trips to Mt. Brighton on Feb. 15 and 17. Registration fee is \$45 for one trip and \$80 for two trips. Non-resident fees apply. These trips will be for Junior Club members only. Each student will receive a Club ID and Instructional lessons. Luxury motor coach transportation is also included. Helmets will be required for all participants and chaperones. Registration began Sept. 15.



PHOTO BY DAVID AGUILAR/RECORD EDITOR

Haley Collins, 8, was visiting family in Northville Thursday for Thanksgiving when she took some time out to tackle the hill at Amerman Elementary School.

### Open Badminton

Competitive style badminton. All skill levels are welcome. Cost is \$7 per night, includes bird fee. On Tuesdays and Fridays 7-9:30 p.m., Northville Parks and Recreation (248) 449-9947.

### Open Table Tennis

Eight tables available. All skill levels are welcome. Cost is \$4 per day Mondays 6-10 p.m., Saturdays 12-4 p.m.

### Open Basketball

At the Senior Community Center on most Tuesdays from 7-9:30 p.m., Cost is \$3. Please contact Northville Parks & Recreation for more information.

### Toddle Time

Attention: Mom, Dad, Grandma, Grandpa and Nannies! Your toddler will have a blast during this drop-in open gym time. A wonderful opportunity for toddlers to learn through play. Tots can run, jump, play ball, laugh and giggle with other tots in a safe atmosphere. Also the little ones will begin learning socialization skills. An adult must accompany children for the entire time. Please bring a toy your toddler can ride or push. A limited amount of equipment will be available on site during this unstructured playtime. Please pay building attendant \$3 per person (adult and children) and bring correct change. Price is for two hours of gym time. Sorry, no pro-rated time fees. Toddle Time is held on Tuesdays until Dec. 14 from 10 a.m.-12 p.m. at the Senior Community Center Gym.

### Youth Winter Basketball Leagues

Player registration is under way and will end Nov. 24 (or when leagues are full). Teams will be formed for girl's grades 6-8 and 9-12 and boy's grades 8-9 and 10-12. All leagues will play an eight or 10 game schedule, primarily on Saturdays, starting Jan. 15. A coaches meeting for all teams will be held Dec. 15. Teams will practice one or two nights each week beginning Jan. 3. Contact Dave DeMattos at (248) 349-0203, ext. 1405, for more information.

### Coaches Wanted

Adult coaches are needed for the youth basketball program. The coach's Child will play for free when the coach volunteers. If interested, or if you would like more information contact Dave DeMattos at (248) 349-0203, ext. 1405. Volunteers make these programs successful, so please call today.

### Rudolph's Road Rally

Are you looking for something fun to do with friends and family during the hectic holiday season? Look no further!

Northville Parks and Recreation is having a Road Rally on Saturday, Dec. 11 from 5-9 p.m. In this road rally you will meet at the Northville Senior Community Center, and then follow the clues given to you while taking wacky pictures (worth different point values) of your team's journey. There is a pizza dinner with prizes immediately following the rally at the Northville Senior Community Center. Sign up your team at the Recreation Center at Hillside from 7 a.m.-4:30 p.m. Monday through Friday. Deadline to register your team is Friday, Dec. 10, at 12 noon. Cost is \$12 for adults and \$8 for children 13 and under. Number of people on a team is limited to the number of seatbelts in the car you will be driving. Driver must have valid drivers license. Make sure to have a full tank of gas and bring either a regular size Polaroid camera with at least two packs of film, or a digital camera with a printer. For more information call Tammy at (248) 349-0203 ext. 9948.

### Northville Nite 2004

It's time again for that wacky, wild wonderful winter's eve! Join us for an unbelievable night of giant toys, carnival games, awesome music and exceptional food. Northville Nite is the place to be on New Years Eve! This year's event will feature woodcrafts with Home Depot, carnival prizes from Oak Pointe Church, and dinner catered by Max and Erma's of Novi. Tickets are limited and do sell out so come to the Recreation Center at Hillside offices between 7 and 4:30 p.m. to buy yours today! Northville Nite is on Friday, Dec. 31 from 5-9 p.m. at the Recreation Center at Hillside. Tickets are \$15 for adults, \$10 for kids and \$5 for tots. Please call Emily Sherman at (248) 349-0203 ext. 1411.

### Registration

All students in Middle School and High School are encouraged to participate. Club membership includes luxury motor coach transportation to local ski areas on Friday evenings and some Saturday evenings, group lift tickets, rental equipment discounts and lessons at Mt. Brighton Ski Area. Two additional trips have been added this year! Registration fee is \$155 for City and Township residents, \$160 for school district residents in the City of Novi and \$165 for non-residents. Please bring a current school photo and last year's club ID card. Adult chaperones are needed to chaperone trips and receive complimentary skiing. Contact the Parks & Recreation Department office for more information.

## Regional

### Nutcracker Ballet

The Plymouth Symphony Orchestra will join with the Plymouth-Canton Ballet Company to present the classic fairy tale-Tchaikovsky's Nutcracker Ballet. Performances will be Saturday, Dec. at 11 a.m. and 4:30 p.m.; Sunday Dec. 5 at 2 p.m. at Salem High School Auditorium, 46181 Joy Road, Canton. Admission is \$20 for adults and \$10 for children. For more information, please contact the Symphony office at (734) 451-2112.

### Lightfest

The Wayne County Parks Lightfest will be until Jan. 1 from 7-10 p.m., closed on Christmas day. Lightfest features over 35 giant animated displays and over million lights. The route is over four miles of Hines Drive in Westland, Merriman Hollow Area. Dec. 7, 14 and 21 will be Toy Nights in which the community is invited to bring a new toy or \$5 donation fee for disadvantaged children in Wayne County. For more information, please call (734) 261-1990.



PHOTO BY DAVID AGUILAR/RECORD EDITOR

Five-year City of Northville residents Molly and Bill Drelman walk with their 19-month-old son, William, along Walnut Street, near East Street last Thursday.

### Northville Ski and Snowboard Club

December 4, 6am-Midnight

**KOHL'S**

# Super Saturday

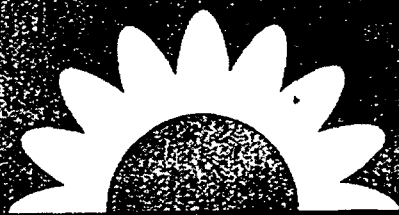

6am to Noon only

**EARLY BIRD SPECIALS**

**EARLY BIRD SPECIAL**



sale 59.99  
Your choice  
-2-pc. freshwater pearl necklace and pair of stud earrings set  
-pair of 10k gold 1/4 ct. T.W. baguette diamond hoop earrings  
-pair of 14k gold 1/4 ct. T.W. princess cut diamond stud earrings  
reg. \$200 & \$225 ea.

**70% off entire stock**  
fine jewelry

reg. 29.99-5,000.00, sale 8.99-1,500.00  
Photo enlarged to show detail.  
Diamond Total Weights are approximate. T.W. may vary up to .05 ct. Actual savings may exceed the percent savings shown.



**EARLY BIRD SPECIAL**

**50% off entire stock**  
Russell® Athletic fleece separates for men & misses and Champion® fleece separates for men

orig. \$24-\$38, sale \$12-\$19

**EARLY BIRD SPECIAL** by Vision Goggles



**10-40% off plus**  
save an extra 20%  
entire stock toys



**EARLY BIRD SPECIAL**

**60% off entire stock**  
leather and suede outerwear for men & women

Excludes Columbia Sportswear Company.  
orig. \$100-\$380, sale 39.99-149.99

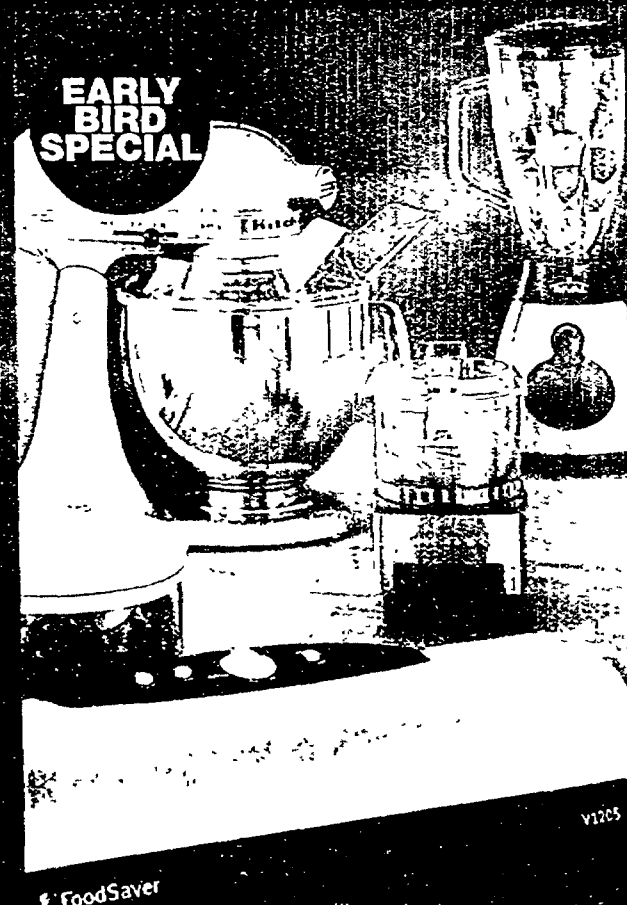

**EARLY BIRD SPECIAL**

**10-40% off plus**  
save an extra 15%  
entire stock kitchen electrics



**EARLY BIRD SPECIAL**

**40% off entire stock**  
watches

reg. 19.95-475.00, sale 11.97-285.00

For the Kohl's Store nearest you, call 1-800-837-1500 or visit us at Kohls.com

\*Sale prices and percentage savings offered in this advertisement are discounts from Kohl's "Regular" or "Original" prices. The "Regular" or "Original" price of an item is the former or future offered price for the item or a comparable item by Kohl's or another retailer. Actual sales may not have been made at the "Regular" or "Original" prices, and intermediate markdowns may have been taken. Clearance merchandise is excluded from "Entire Stock" promotions in this advertisement. In some events, actual savings may exceed the percent savings shown. KOHL'S® & KOHL'S brand names are trademarks of Kohl's Illinois, Inc. © 2004 Kohl's Department Stores, Inc.

Elton John photography by Michael Caulfield.

# SAVE UP TO 70% ON THESE LIST-TOPPING GIFTS

Excludes Canon digital camera.

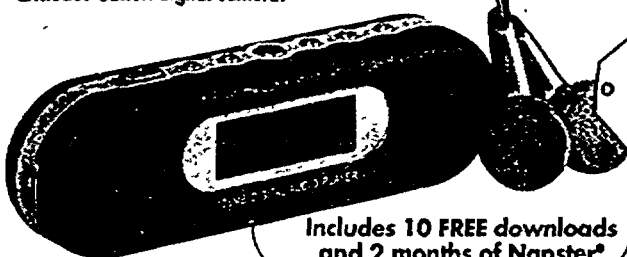

**69<sup>99</sup>**  
After Mail-In Rebate

SAVE \$30

Includes 10 FREE downloads and 2 months of Napster\*

**128MB\* Digital Audio Player**  
At just .7" thick and only 1.3 ounces, this highly portable player is perfect for taking your tunes wherever you go. (DFP-70) 6771317 Reg. Price \$99.99 - \$30 Rebate = \$69.99  
\*Formatted capacity may vary

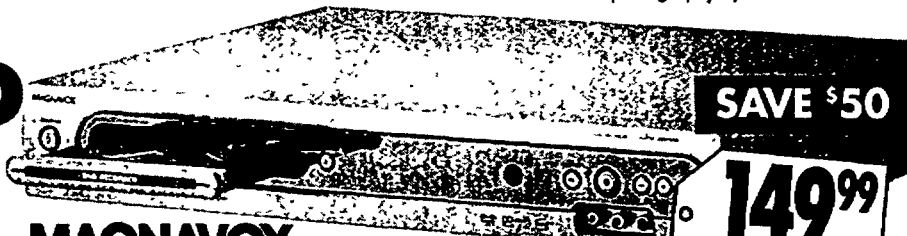

SAVE \$50

**149<sup>99</sup>**  
After Instant & Mail-In Rebates

**MAGNAVOX DVD+R/RW Recorder with Progressive Scan**  
Record up to 8 hours of video per DVD disc • Front A/V connections • Component video out and Dolby® Digital coaxial output (MLY640) 6402957 Reg. Price \$199.99 - \$20 Instant Rebate = \$179.99 - \$30 Mail-In Rebate = \$149.99

**TOSHIBA SAVE \$350**

**Intel® Celeron® M Processor 340 Notebook with DVD/CD-RW Combo Drive**  
Processor speed 1.5GHz • 256MB DDR SDRAM • 60 gigabyte hard drive • Integrated 802.11g wireless LAN (s149) 6851267

Minimum \$ per store. No rainchecks.  
Reg. Price \$999.99 - \$50 Instant Rebate = \$949.99  
\*150 Best Buy Mail-In Rebate - \$150 \$119  
Mail-In Rebate = \$649.99



**649<sup>99</sup>**  
After Instant & Mail-In Rebates



Intel, the Intel Inside logo, Celeron and Pentium are registered trademarks. Centrino is a trademark of the Intel Corporation.

**DOUBLE THE MEMORY ON THIS NOTEBOOK** 5320789  
PROFESSIONALLY INSTALLED BY GEEK SQUAD® AGENTS FOR (INSTALL 02) 1478877  
Reg. Price \$99.99 - \$50 Instant Rebate = \$49.99 + \$29 Installation - \$29 Bundle Instant Rebate = \$49.99



SAVE \$30

**SANSUI Stereo TV**  
Front A/V inputs make connecting to video games a snap. S-video inputs. (TYS2746) 4442186

**149<sup>99</sup>**  
After Instant Savings & Mail-In Rebate

Reg. Price \$199.99 - \$20 Instant Rebate = \$179.99 - \$30 Mail-In Rebate = \$149.99



# 18 MONTHS

NO INTEREST\* FOR

Now through Saturday!

**EVERY DEPARTMENT • EVERY BRAND • EVERY PURCHASE TOTALING \$299 & UP—INCLUDING GIFT CARDS**

# STOREWIDE!



**1999<sup>99</sup>**  
After Savings

Reg. Price \$2299.99

**zenith Widescreen LCD Projection HDTV Monitor**  
Sharp picture in a compact cabinet with this LCD projection TV. Only 14.5" deep and 80 lbs. Use the 2-tuner picture-in-picture to keep an eye on multiple games or shows. (E44W461C0) 6621925

SAVE \$300

**FREE \$50 Gift Card**  
Instantly with purchase of this digital camera. Good toward future in-store purchase.

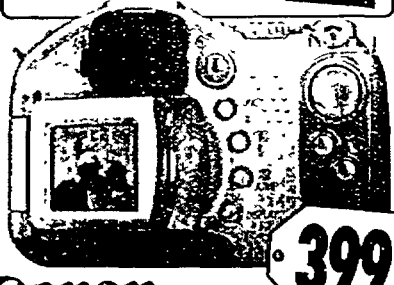

**399<sup>99</sup>**

**Canon Powershot™ 3.2 Megapixel Digital Camera**  
with 10X Optical/3.2X Digital Zoom (ST15) 6283862

SAVE \$50



**599<sup>99</sup>**  
Before Instant Savings

**SONY Digital Camcorder with Built-In Digital Still Camera and 10X Optical/120X Digital Zoom**  
Carl Zeiss® lens • Super NightShot™ Plus • Super SteadyShot™ Memory Stick™ Duo • PiCTBridge compatibility for PC-free printing (DCRH40) 6237306

SAVE \$100

**MOTOROLA Digital Camera Phone**  
with Speaker Phone, External Display and Voice-Activated Dialing (Y220) 6785482  
Reg. Price \$99.99 - \$100 Instant Savings = Free (Sales tax not included.)

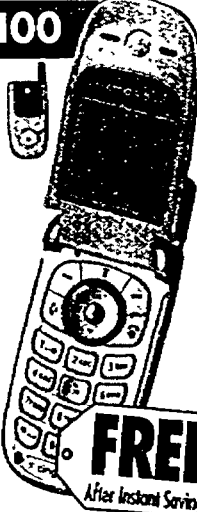

**FREE**  
After Instant Savings

New activation and 2-Year Cingular plan agreement required.  
Not available in all markets.

SAVE \$50



**99<sup>99</sup>**  
After Mail-In Rebate

**LEXMARK P315 Compact Photo Printer**  
Quickly print borderless 4" x 6" photos directly from memory cards or a PiCTBridge-enabled digital camera. 6800964  
Reg. Price \$149.99 - \$50 Rebate = \$99.99  
Quantities limited. No rainchecks.

**P315 Print Pack** ..... **39<sup>99</sup>**  
Includes ink and paper for 140 photos. Less than .29 per print. 6880235

SAVE \$60



**49<sup>99</sup>**  
After Mail-In Rebate

**Seagate 120GB Internal Hard Drive**  
with 8MB Buffer  
Store 30 2-hour DVD-quality movies, 120 hours of VHS-quality video, 30,000 high-resolution digital photos or 82 days of around-the-clock MP3 audio. (ST3120026A) 635566988

SAVE \$25



**9<sup>99</sup>**  
After Instant Savings & Mail-In Rebate

**MIDLAND Up to 7-Mile 2-Way Radio Pair**  
22 channels • Scan • Auto battery save prolongs battery life • Automatically scans channels for activity • Key pad lock • 2 watts of power (GXT200) 6345644

SAVE \$20



**79<sup>99</sup>**  
After Savings

**Dual 52-Watt x 4-Channel CD/CD-R Deck**  
with RCA preouts and remote. (XD6210) 6201656

\*Required minimum monthly payment is greater of \$10 or 2.25% of balance. Interest will be charged to your account from the date of purchase if plan balance is not paid within 18 months or if minimum monthly payments are not made. Online offer may vary. **Financing Info:** Subject to credit approval on Best Buy consumer credit card by Household Bank. Min. finance charge = 2%. Certain rules apply to the allocation of payments and Finance Charges on your promotional purchase if you make more than one purchase on your credit card. Call 1-888-367-4310 or review your cardholder agreement for information. **Deferred Interest Info:** Variable Standard APR = Prime Rate + 14.4 percentage pts. (19.8% as of 11/1/04) Variable Default APR = Prime Rate + 18.4 percentage pts. (23.8% as of 11/1/04) Standard Min. APR 19.8%. Default Min. APR 23.8%.  
\*To receive digital content, a digital receiver is required. Sold separately.  
\*FCC license required. See package for details.



**Price Guarantee:** 30 days from purchase (14 days for select items). If a local competitor (excluding Internet) has a lower price on the same available brand/model, we'll refund the difference plus 10% of the difference. Present lower price verification and original Best Buy receipt for refund. Excludes special, bonus, fine and financing offers and, in CA, cellular phones/pagers. Ask customer service for details. Rainchecks and Limitations: Unless noted, rainchecks are available for advertised products. We reserve the right to limit quantities. Unless noted otherwise, Best Buy rebates limited to one per product per household or address. Other limitations may apply.

Prices and offers good December 2-4, 2004.



**South Lyon Lumber**  
presents  
**LADIES NIGHT**

**1st Annual Ladies Night**  
Thursday, December 2, 2004 • 6-9 PM

Three Grand Prize Drawings 7, 8, 9PM  
**Gift Bags** For the First 300 Ladies! (Must be 18 years of age)  
Door Prizes every 10 minutes

South Lyon Lumber • 415 East Lake St.

**BISTRO 127** 127 E. Lake St., South Lyon 248-437-9000

Dave King's **ELVIS Christmas Show**  
Friday, December 10<sup>th</sup> • Showtime 8PM  
Dinner & show tickets \$25.00  
Show tickets only \$10.00

**Eggs Benedict SUNDAY BRUNCH**  
New Waffle Station  
with fresh Fruit Toppings  
A wider selection of Breakfast Breads  
Luncheon Items have been added for after 11am

Adults \$6.95  
Seniors \$4.95  
Kids \$3.95

**Diane's Doll House**  
TOYS, DOLLS & MORE  
15 Year CELEBRATION!  
20% - 50% OFF STOREWIDE  
Excludes Certain Merchandise

Sales through December

Santa's Favorite Shopping Stop

FREE Surprise Gift with your purchase of \$25.00 or more while supplies last

THOMAS & FRIENDS  
DISNEY RAILROAD

102 N. Lafayette (corner of 10 Mile & Pontiac)  
South Lyon, MI 48178  
248-486-0450

**HAPPY HOLIDAY HINTS**

**South Lyon Lumber**  
Thursday, Dec. 2, join South Lyon Lumber for their "1st Annual Ladies Night," from 6 to 9 p.m. Enjoy a great night filled with demonstrations on faux painting, chainsaw carvings, appetizers, music and a chair massage from one of the three masseuse on hand. Get your holiday shopping done early. South Lyon Lumber is located at 415 East Lake Street.

**Bistro 127**  
offers a wide variety of steak, seafood and pasta dishes to please everyone's palate. Visit our new Gourmet-to-Go for a large selection of freshly made sandwiches and more.

**Diane's Doll House**  
is celebrating their 15th anniversary! Join in the celebration with storewide specials going on now, and throughout the Holidays.

**Digicom Electronics, Inc.**  
Same Location for 15 Years  
Digicom Electronics, Inc.  
DISH Network Satellite Systems  
Free equipment & installation  
Visit our showroom  
See our HD & Digital systems

**Perfect Floors**  
We offer a large selection of carpeting in our showroom, which includes a Mohawk Color Center. We also offer a variety of ceramic, hardwood, laminate and vinyl floor-covering products. Most orders are installed within seven days, which means there is still time to replace your flooring before the holidays arrive. Stop by and visit our showroom today.

**Theiser Equipment Company**  
Theiser Equipment Company has been providing outdoor power equipment to our community since 1965, and is best known as our local "John Deere" dealer. Check them out at [www.greentractors.com](http://www.greentractors.com) or call 1-800-870-9791

**South Lyon Cycle**  
We have high-quality bikes for the entire family at great values. Indoor trainers and a large selection of bike accessories are in stock for the bicyclist on your gift list.

**Selective Heating**  
Selective Heating has 27 years experience servicing & installing furnaces, boilers, air conditioners & radiant heating. They are a Bryant dealer but service all makes & models.

**DISH NETWORK SATELLITE TV**  
NO EQUIPMENT TO BUY

CONNECT UP TO 4 TVs WITH DIGITAL HOME ADVANTAGE

Get over 60 channels plus local channels  
Discovery Channel ESPN Disney Channel USA Network TNT and many more...  
STARTING AT \$29.99/mo

TV for the whole house. It's easy & simple!  
Pay a \$49.99 Activation Fee and get a \$49.99 credit on your first bill, making your activation FREE.

- ✓ FREE equipment upgrade to DISH Player-DVR and HD receivers
- ✓ FREE Standard Professional Installation on up to 4 TVs

Sign up for 2 years and get DISH Home Protection Plan Free.\*

HOME OF THE LOWEST ALL-DIGITAL PRICE IN AMERICA... EVERY DAY!

**DialComm Electronic, Inc.**  
22882 Pontiac Trail • South Lyon, MI 48178  
(248) 486-4343 • Same Location For 15 Years ★

**TORO ATTENTION ALL TORO**  
**WINTER WARRIORS:**  
Theiser Equipment Company SELLS & SERVICES the most recognized name in **SNOWBLOWERS!!**  
www.toro.com

STARTING AS LOW AS **\$359**

FREE!!  
Free Gas, Free Service & Assistance With Every Blower!

Act Now And Receive...  
**NO INTEREST, NO PAYMENTS**  
Until JULY 2005!!!

**Theiser Equipment Co.**  
28342 Pontiac Trail • South Lyon • Michigan • 48178  
Phone: 248-437-2091 Fax: 248-437-2140  
Toll Free: 1-800-870-9791  
[www.greentractors.com](http://www.greentractors.com)

**SOUTH LYON CYCLE**  
209 S. Lafayette ( Pontiac Trail)  
2 blocks south of Ten Mile  
Downtown South Lyon  
(248) 437-0500

TREK GIANT HARD ~~ROAD~~ townie  
Large Selection of High-Quality Bikes for the Entire Family at Great Values

Kids	From \$119.95
BMX	\$159.95
Cruiser	\$199.95
Mountain	\$219.95
Comfort	\$269.95
Hybrid	\$279.95
Road	\$559.95
Adult Tri-Wheeler	\$329.95

Gift Certificates & Layaway Available  
also Great Accessory Gift Ideas

**Perfect Floors**  
Still Time to have new flooring installed before the holidays! All floor covering now on sale.

Guaranteed Lowest Prices

South Lyon Showroom  
21946 Pontiac Trail  
south of Nine Mile Rd.  
Most Orders Installed 7 Days

Rochester Hills Showroom  
1015 John R  
corner of John R & Avon

Mon, Tues, Wed, Fri 9-6  
Thursday 9-7, Sat 9-5  
248-437-2838

Mon, Wed, Fri 9-8  
Tues & Thurs 9-6, Sat 9-5  
248-650-5199

FREE Credit 6 months\*

NO PAYMENTS NO INTEREST until Jan 2005!

\*Financing based on credit approval. Min. \$500 purchase. \$125 down payment. Prior credit check required. See dealer for details.

Seasons can be harsh. Especially when it comes to your heating system. This year, make sure you're prepared for what's ahead by calling your local Bryant dealer.

**Selective Heating**  
for a check up. With Bryant by your side, you can rest assured both you and your units will survive the upcoming weather.

**MAKE SURE BRYANT VISITS YOUR FURNACE BEFORE WINTER DOES.**

**Selective Heating**  
29301 Garrison Rd.  
Wixom, MI 48393  
248-486-4640  
servicing all makes & models

# Sole Sisters

## New shoe store invites women to step out in style

By Maureen Johnston  
RECORD STAFF WRITER

Lauren Beras picked up a furry pink purse with black leather trim and asked smiling, "Is this Betty Rubble meets Barbie, or what?"

That's the enthusiasm and unique product appeal Northville's newest boutique owner brings to her selection of women's shoes and accessories.

Sole Sisters, 142 N. Center St., officially opened Nov. 15.

Beras' enterprise with her husband Bob is the first franchise of the same-named Royal Oak retailer that features fashion-forward footwear seldom found in malls.

"If the malls carry it, typically we won't," she said. "I don't want to go crazy on high-priced designer shoes. I pick the designers I like."

"I have a range of party shoes to comfortable shoes."

Sole Sisters' price range is \$10-\$300, Beras said, on jewelry, purses and shoes. "Women want comfort and pretty. Some things you want to wear to an event. Then you want things you can live in."

Round toe, pointed toe, squared off toe — it's all about what piques your interest, the store owner said. "It's what looks good on you. I think real fashion-forward people put together what they like. It's all about

personal style. "The women come in here excited and they leave even more excited."

During buying trips at shoe shows in Las Vegas, Chicago and Livonia, she plans to purposely buy limited quantities so customers are not likely to see their selection walk past them on the street.

### Personal touch

Beras said she "stalked" Northville stores for months before deciding this was the perfect location for her shop. The warm welcome from her fellow retailers and early patrons has affirmed her decision.

"The demographics are perfect out here," the store owner said. "We have moms. We have careers. We have a real broad mix."

"The women out here have a real sense of style. It's an interesting mix of down home and city flair."

Downtown Northville is the perfect combination of a street-shopping town catering to women, that's both quaint and warm, she said.

"I thought I really found my niche here," she said. "I found a little bit of everything here, but me."

The persona of Northville's newest entrepreneur may return customers as much as her pony-hair fashion boots, high-style handbags and one-of-a-kind jewelry. She's a

### SOLE SISTERS

Sole Sisters  
142 N. Center St.  
(248) 348-9270

Store Hours  
• 10 a.m.-5:30 p.m.,  
Monday-Thursday; 10 a.m.-8  
p.m., Friday and Saturday; 12-5  
p.m., Sunday.

wife, a mom, a business owner, a shopper, an events planner and jewelry designer. She's also a minister, actress and inner-city mission founder.

"There's nothing that I want to do in my life that's not centered on the Lord," she said. "You're blessing me by coming in to my store. I want to reward people for that."

"People who walk in are going to be served."

Her life experiences and embracing nature translate into easy customer empathy. She also recognizes the I-want-to-shop-without-assistance attitude.

"You've got to know your product," she said. "You also want to know your customer. Some women don't know what they want. They want."

And while they sample the tall zippered boots, pumps or slipper shoes, there's ESPN or Nickelodeon for the rest of the family. "The men that aren't shopping — they have something they can do."

### Unique appeal

Beras said she believes the coincidences leading to her starting her store now mean it is in right place at the right time.

When the owners of the Royal Oak Sole Sisters location sought to



Photo by JOHN HEIDER/NORTHVILLE RECORD

Lauren Beras and her husband Bob have recently opened the "Sole Sisters" shoe shop in Northville at 142 N. Center. Beras has shoe and jewelry items ranging from \$10-\$300.

franchise, Beras was first in line. She filled in as manager and fell in love with "playing shoe store," she said.

With their product-line access, her Northville landlord's endorsement and the setting's aura — Beras recounted how Sole Sisters' entrance into Northville was unfolding flawlessly when her dad, Sherwin Evans, died.

From the sadness, she reached through her faith to retrieve the belief she is on the right course.

Her dad was so proud of her efforts, she said. She dove back into the venture.

People who enter the former Slavika gallery will see brick, simple shelving and showcases, and corrugated steel walls the owners erected to highlight the cutting-edge products.

Beras this past weekend joined in the Northville Chamber of Commerce's Christmas Walk extended hours. Regular hours will be: 10 a.m.-5:30 p.m., Mondays-Thursday; 10 a.m.-8 p.m., Fridays and Saturdays, and noon-5 p.m., Sundays.

"I've been a shopper a long time," she said. "I know what I like to see in

a store and I know how I want to be treated in a store."

The merchant said she hopes the concept of shoe parties will catch on in Northville. The host and guests receive a discount during a two-hour event when wine and cheese or cake and coffee are served. "Busy women have a chance to have fun with their friends," Beras said.

The store owner's belief in her venture will be part of the success formula. Her mission downtown: help women feel good about themselves.

# Shop around for the best rate. (Please.)

## Circle Money Market Account.

# 2.75% APY

Balances of \$50,000 or more  
Rate guaranteed through July 1, 2005  
FDIC insured

To open an account, call 1-877-TOP-RATE or visit us in person at any Charter One Bank branch.



# RASHID HOME IMPROVEMENT & GARAGE DOORS, INC.

## Give a Great Gift This Holiday.

### Give Them Something They Really Need... a New Garage Door Opener From Rashid!



Lift-Master 25th Anniversary  
**Special Bonus**  
**FREE**  
Wireless Keyless Entry System  
**PREMIUM ACCESSORIES**  
a \$79.99 Value!  
2 Remote Controls

Rashid is Metro Detroit's 31 leader for sales, service and repair on all makes & models of garage doors & remote openers. All Models of Lift Master in stock!

**SATISFYING the METRO AREA for OVER 30 YEARS**

- Kitchens • Baths • Siding • Doorwalls
- All installed by the best!**
- Repairs • New Construction
- Insurance Work • Retail • Wholesale

CHAMBERLAIN  
**Lift-Master**  
PROFESSIONAL

- Unique "floating motor" design eliminates vibration for the smoothest, quietest operation available
- The Protector System® automatically reverses door if any object breaks the safety beam
- Security+™ anti-burglary coding
- Drive belt as strong as a steel belted tire

**1/2 H.P. Belt Drive**  
2265 Chain Drive, 2280 Belt Drive,  
2220 Screw Drive, 2500 DC Motorbelt,  
2575 3/4 HP Chain-Estate Series

**20% off**  
Wood & Steel Entry Doors &  
Windows Plus Fox Storm Doors &  
the latest in Gilding Door Walls by  
Polaris & N.R.G.  
with purchase  
Call RASHID TOLL FREE: 888-353-8881  
One coupon per household • Expires 2-15-05



**GIFT CERTIFICATE**  
Available For  
All  
Products

31290 Freedom Road • Farmington Hills  
**Call: 248-474-3846 or...**  
**Toll Free: 1-888-353-8881**



# SPORTS

Northville Record



IT'S FINALLY HERE!

HomeTown Newspapers has made the fans wait, but the highly-anticipated All-Area Dream Teams have been selected. See who's who in Northville sports.

— Page 1B

## Mustangs skate to two early-season wins

By Sam Eggleston  
RECORD SPORTS WRITER

The Northville hockey team breathed a long, well-deserved sigh of relief after their first three games. The squad proved to themselves, and everyone else, they can win.

"It's always nice to get that first league game behind you," said Northville coach Brad O'Neill.

Northville earned wins over Walled Lake Western and Livonia Stevenson. They lost to Farmington in double overtime.

"We didn't play our best games," O'Neill said. "The guys were pretty disappointed in the locker room with how they played."



Goalie Jimmy Gates took both wins and the loss.

Against Walled Lake, Northville earned a 4-2 victory. Northville had goals scored by Derek Mohacsi, Nick Guerro, Joe Vitale and Mike Monticciolo.

Gates stopped 18-of-20 shots against him.

"Western played very aggressive," said O'Neill. "They took a lot of penalties. We took a lot of penalties too, but not nearly as many as they did. It was a real special-team type of game."

The Mustangs had to play without Max Lenn, who had injured his knee in the opening week. He sat out much of last season from a knee injury, but is expected to return soon with a brace this year. Rob McTavish was also out due to injury.

"Overall it was a good league game," O'Neill said. "I was happy that we went out and won it."

### Michigan Showcase

Northville split their tournament play against Livonia Stevenson and Farmington United.

The Mustangs beat Stevenson, 3-1, but fell 5-4 to Farmington in double overtime.

"That's a tough game to lose," O'Neill said. "We had our best period of the year so far in that one."

Northville jumped to a 3-0 lead in the first period on goals from Don McKinnon and two from Guerro before Mohacsi added one of his own in the third to cap the scoring.

Against Stevenson, Northville jumped to a 1-0 lead with score from McKinnon before Tim Fick added another goal on a game-winning shot in the third. Mohacsi collected the final tally in the game.

"We were happy with how we started the season," O'Neill said. "We faced two very tough teams and played well."

The Mustangs are currently 2-1 on the season.

From Mustangs to Cheetahs — it's all about speed



Submitted Photo

After a successful and challenging season with the Northville boys cross country team, freshman Jake Myers went on to run with the Detroit Cheetah Track Club. He recently competed in the USA Track and Field Cross Country State Championships at Cass Benton and finished 25th overall. The finish qualified him for the Region 5 Championships that were held Nov. 20th. There, on an extremely muddy course, Myers finished 14th to qualify for the National Championship. The final meet is slated for Dec. 11.

## Champion Marlins reflect on solid season

Ask the 2004 Northville H-League Florida Marlins to name the highlight of their season. Will these young athletes say it was winning the Pizza Cutter Tournament? Winning the World Series? Achieving a 21-1 record?

What do the coaches and parents say? Are they most pleased with the boys' teamwork and never-say-die attitude? Or maybe how the Marlins reaped the benefits of practice, focus and an occasional rally cap?

Whatever the choices, everyone agrees the list of highlights includes the day the Marlins met the Tigers at Comerica Park. Northville's Marlins were VIP guests when the Detroit Tigers faced the Kansas City Royals on near the end of the baseball season.

As pre-game preparations swirled

around them, the Marlins stepped onto Comerica Park's grassy carpet. The Marlins watched in reverent awe as the Tigers took batting practice. The silence was broken when player-turned-coach Kirk Gibson came by to meet Northville's H-League Champs. Pandemonium broke out when the team snagged autographs from Gibson, Carlos Guillen, Tiger broadcaster Dan Dickerson and All-Star catcher Pudge Rodriguez.

Marlins' head coach Jeff Laya and assistant coach Jim Armaly were as impressed as their young players. They excitedly pointed out the Tigers' different batting techniques and helped the boys appreciate the unique perspective they had — seeing the ballpark from a Tigers' point of view.

"We learned about the locker rooms, umpires' room — and even the kid-friendly room where the players' children spend time," enthused Tom Gove, Marlins' first base coach for the past two seasons. Gove's wife Vera had alerted the Tigers' front office of the Marlins' exceptional season, prompting the invitation.

Summing up the feelings of most Marlin parents, one mother mused, "Our sons will tell their children about this season. It was unforgettable for all of us. It was a season of dreams. Dreams come true."



Submitted Photo

Northville's H-League World Series Champion Marlins after their June 30 victory: (Left to Right) Back row: Coaches Jim Armaly, Jeff Laya, Tom Gove; Behind sign: Tyler Harrigan, Max Grezlik, Andrew Slatin, Max Eitelman, John Armaly, Matt Gove, Chris Leja; Left of sign front to back: Emmitt Zimmer, Scott Matthews, Jon Sloane; Right of sign front to back: Ethan Price, Sean Wagner, Jared Myers.

## Help the Kids Donate Your Vehicle

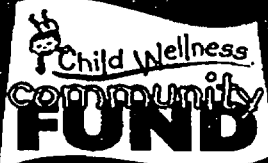

Great Tax Benefits, Blue Book help, Pick-up, Transfers & Tax Forms.

1-888-CWF-GIVE

www.childwellnessfair.com

## Now Open... To Serve You!

Say goodbye to stressful menu parsing, grocery shopping, food preparation and kitchen cleanup.



From Our Kitchen to Yours

### It's Dinner Thyme!

Spend a couple of hours in our kitchen and prepare 12 home-cooked meals to serve to your family and friends for less than \$2000 that's only \$27.50 per person per meal!

Relax in our cozy environment. Come with friends or meet new ones. Share the experience that will make your dinner hour more calm and family friendly.

Register for a session at [www.dinnerthymeonline.com](http://www.dinnerthymeonline.com)

Dinner Thyme has fresh ideas when it comes to planning your next party. Schedule a private session any day of the week!

Baby Shower • Office Parties • Birthdays • Family Reunions

753 Canton Center Road  
Canton, MI 48107  
734-414-1744

What's better than free checking?  
The \$50 you can get with it.



- Get \$25 for setting up direct deposit.
- Get \$25 for paying your first bill online.
- Free first order of checks.
- Free Debit Card.
- Free Online Banking and Bill Payment™

Everybody likes free. That's why we're offering Green Checking™ for free. And everybody really, really likes free money. That's why you can get up to \$50 just for opening a new account and using it the way you normally would.

It's free. It's easy. It's money in the bank. Go to [charterone.com](http://charterone.com) or visit us in person at any Charter One branch.



Member FDIC. Receive a cash bonus of \$25 if ACH direct deposit for the full amount of your payroll, pension or Social Security check (PayPal and tax refunds excluded) is made by February 28, 2005. \$25 bonus for online bill payment will be credited to your account if the first online bill payment is done by February 28, 2005. All monetary bonuses are considered interest for tax purposes, subject to 1099 reporting. Offer subject to change without notice. Green Checking account is a non-interest-bearing account (0.00% Annual Percentage Yield). Minimum opening balance is \$50. 2004 Charter One Bank.



**She shoots, she scores!**

Northville earned two spots on the All-Area girls basketball team this season. Both Evonna Karchon and Simone Toney make return trips to the HomeTown Newspapers Dream Team.

— Page 3B



**Familiar Faces**

The whole point of All-Area is to honor those who have stepped ahead of the pack to lead their teams. Northville this season was well represented on every squad and cross country was no exception.

— Page 4B



**Regional Marketplace**

Santa Claus arrives at Milford Jewelers each year, heart filled with love, gift bag slung across his burly shoulder, eager to renew old friendships. It's the same feeling most shoppers get there. Find out why.

— Page 8B

# ALL-AREA TEAMS

B<sub>1</sub>

"Enjoy the Good Life"

# MISTER SOCCER

By Sam Eggleston  
RECORD SPORTS WRITER

James Hannah made history as an athlete at Northville High School.

Not only did he make the All-State Dream Team for soccer, but he set school records in scoring with 67 goals and 27 assists.

Yet, getting Hannah to even mention his prowess on the field is more difficult than stopping him from displaying it while he's out there.

"I couldn't have done any of it without my team," he said. "I owe every award and every accolade to them."

The Northville senior forward, who scored 25 goals this year and had 10 assists despite missing a handful of games, was never one to put himself above the rest of the crowd.

On the field he's practically unstoppable unless a team focuses their total defensive energy on him. Off the field he's one of the top students in his class.

Hannah isn't ordinary. But, like many who are, he wants to be.

Though colleges have been beating down his door since he was a freshman, Hannah hasn't made a decision as to which he will play for. The likes of Brown University, the University of Chicago and many more are waiting with baited breath, yet Hannah isn't in a hurry.

Why? Well, he might not play college soccer.

"It's definitely a possibility," said Hannah. "My mom (Melissa) is always stressing the importance of academics and a good education. I just haven't found a school that I feel is a good fit yet."

One school that has piqued his interest is the University of Tennessee — the same school his father, Greg, attended. The Volunteers, however, don't have a soccer team.

"A lot of schools in the South are like that," Hannah noted.

At this point, though Hannah hasn't made a complete decision, Tennessee is feeling good.

"I really like it there," he said. "If I go, I'll just play club soccer."

And club soccer is where it all started. As a boy, Hannah played. He met kids like Phil Yutzy, Mike Kelleher and Steve Besk

— all

players that have grown up to be top-shelf soccer stars themselves.

"It's been a lot of fun over the years," Hannah said, looking back over his career at Northville High School.

The Mustangs have had some good runs. Three years ago they lost to Livonia Stevenson in the district tournament final, 1-0. Last year they fell to Saline in the regional final in a shoot-out, 2-1. This season the squad dropped out against Livonia in the district tourney after being ranked first in the state, first in the Midwest and eighth in the nation.

Seasons like that can bring a squad close together.

"We've all been extremely close over the years," Hannah said. "We're all friends on and off the field. I feel like I can tell them anything and vice versa. They're a great group of guys."

Soccer is Hannah. Hannah is soccer. Somewhere between them the line starts to blur. Even on the football field this season people saw him and thought of a soccer player. Even when he walks through the halls of Northville High the thought crosses people's minds.

The sport seems empty without the lifelong Northville resident involved, but he promises it isn't.

"Soccer in Northville is alive and well," he said. "The underclassmen have a lot of talent. I think they'll do just as good, if not better, than this year."

Somewhere there is a player who is the future Hannah. There is a future Dream Team player. A future star. Hannah only has one bit of advice.

"Trust your team," he said. "I pretty much owe everything to them. I have always been surrounded by such great players that are my teammates and my friends. Without them I probably wouldn't have done too much at all."

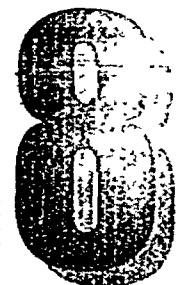

**REASONS WE'LL MISS JAMES HANNAH**

- 8. Red card against Salem. It told us he doesn't mind getting a little testy to defend his team.
- 7. Three-time All-Area selection.
- 6. Member of the 2004 All-State Dream Team.
- 5. Two-Sport athlete in football and soccer and a starter in both.
- 4. His ability to recite the blood-pumping speech from the movie "Braveheart."
- 3. Helping his team to a No. 1 ranking in the state and in the Midwest and eighth in the nation.
- 2. School record 27 career assists.
- 1. School record 67 career goals.

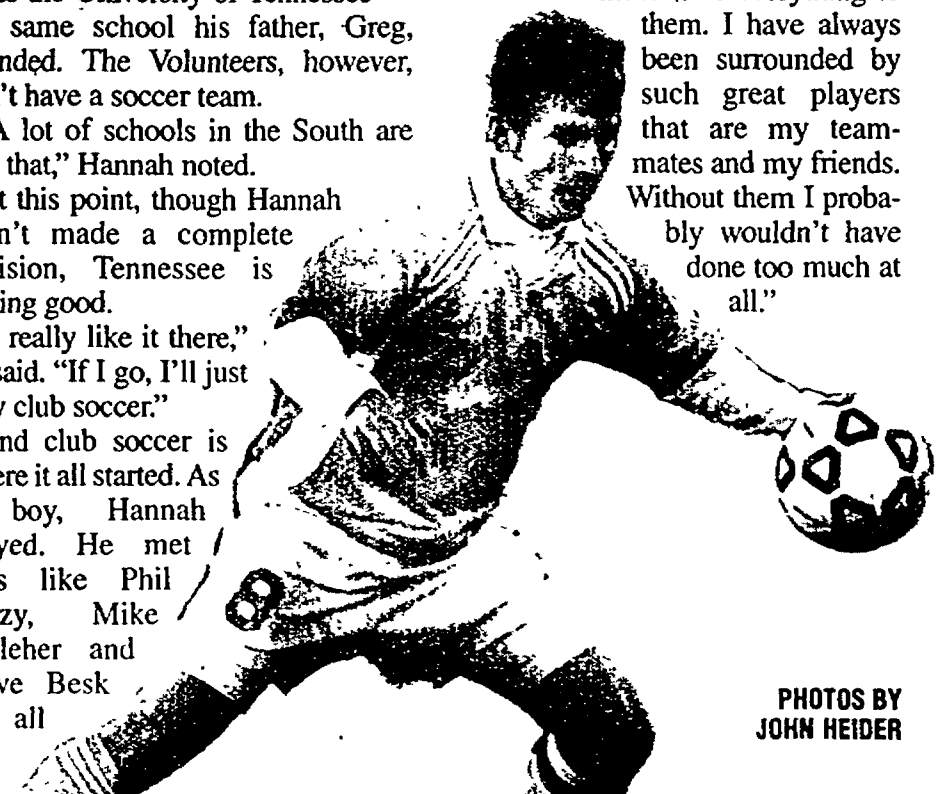

PHOTOS BY JOHN HEIDER

**OTHER TOP ALL-AREA SOCCER PLAYERS THAT WILL BE HARD TO REPLACE**



Scott Hammerle, Senior Defender



Steve Besk, Senior Goalie



Mike Kelleher, Senior Midfielder

# Ruiz selected as All-Area Player of the Year

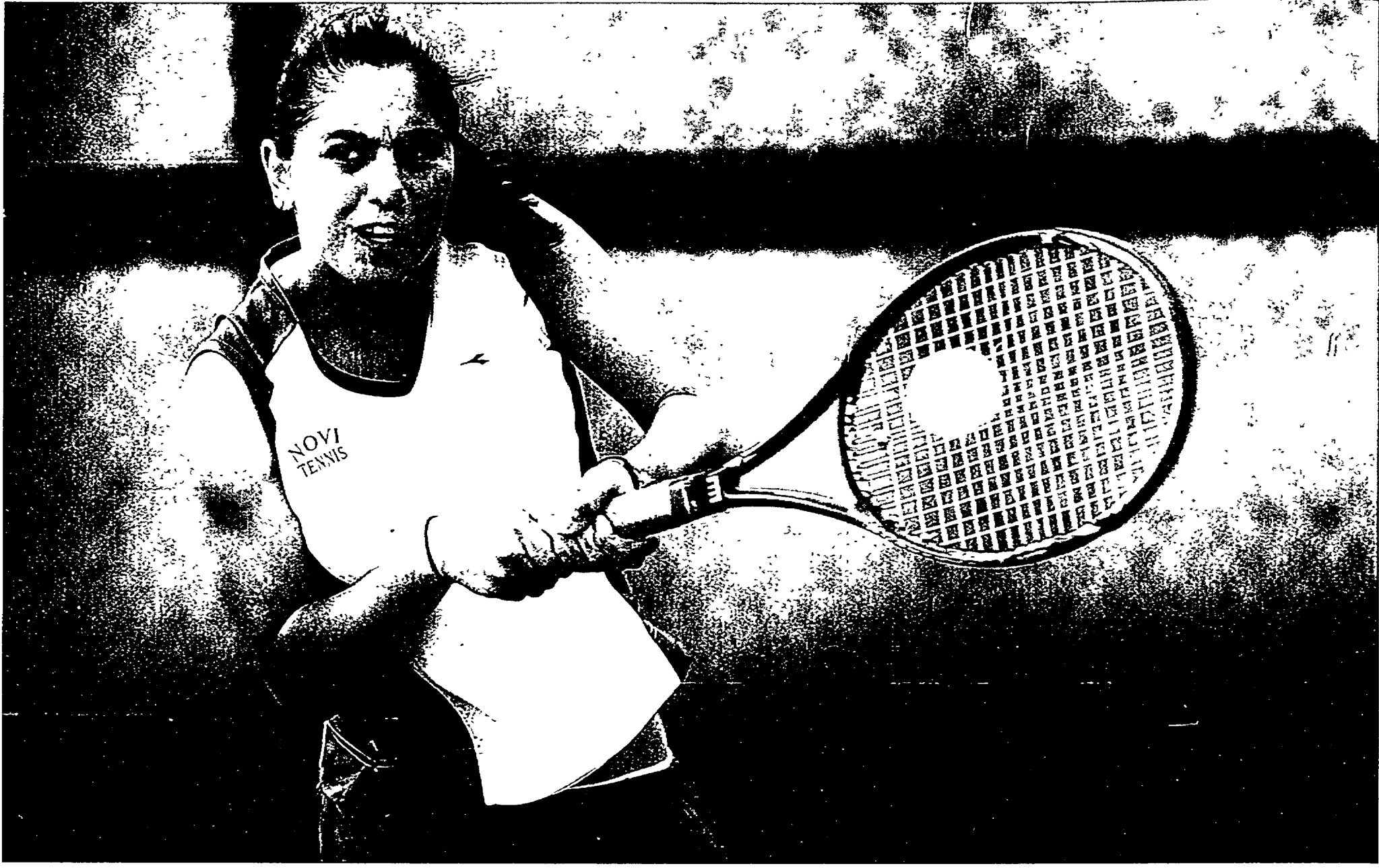

Photo by JOHN HEIDER/NORTHVILLE RECORD

Diana Ticu was selected to this year's All-Area squad. She's a junior at Novi High School.

**By Sam Eggleston**  
RECORD SPORTS WRITER

When it comes to HomeTown Newspapers coverage areas, the Northville Record and the Novi News are truly blessed when it comes to the sport of tennis.

There are few teams that can actually compete with these squads. Be it off-season training, superior coaching or just incredible talent, the Novi Wildcats and the Northville Mustangs are, quite simply, dominant on this list.

## Sophomore sensation

There was a buzz in Northville when sophomore Christina Ruiz decided to move back to town instead of playing tennis in Texas at a national tennis academy.

People were excited — well, most of them — and they knew it could only be positive for the Mustangs tennis team.

## Player of the Year

"Christina has been a great addition to our team," said Northville coach Sandy Woolfall. "She's very talented and is one of the strongest players I have ever coached."

Ruiz didn't disappoint. She came in, earned a place at one singles, and marched to an impressive 20-3 record as the top player in the Western Lakes Activities Association.

The sophomore was WLAA champion and was undefeated through the regional tournament as well where she earned the championship title for her flight.

What does the future hold for Ruiz? Coming in next season as a junior she will be expected to pick up where she left off. Expectations are high, but they always have been for this sensation. Even at a young age she was ranked nationally for her age group.

"I expect she'll have a good career here at Northville," said Woolfall. "She's aggressive and smart."

Pressure isn't something that seems to worry anyone who knows Ruiz.

There are players out there who earn one singles rankings because they are the best on their team. Then, there are players out there who earn HomeTown Newspapers All-Area Player of the Year. Why? Because no one else even compares.

Ruiz is the best of the best. As a sophomore she made an impact on the sport she loves. As a junior and a senior she has the potential to rise up and make an impact at the state level.

## Always competitive

Novi junior Diana Ticu never gives up. No matter how far behind she is in a set or how the match is playing out, she keeps going and keeps going strong.

Even life can't seem to keep her down. Ticu, unfortunately, lost her father this fall. She was playing tennis the same week, focusing herself on the sport she loves and the sport her father loved with her.

"Diana did more than anyone could have asked from her this year," said Novi coach Jim Hanson. "She played when she didn't have to. No one would have asked her to and no one did. She did it because that's what she needed to do."

Ticu was not slouch this season. As a junior she earned the one singles nod at Novi High School and helped lead her squad to yet another Kensington Valley Conference championship.

"Diana is a true leader on this team," Hanson said. "She's extremely talented and had one of her best tennis seasons."

Ticu will be back next season. She'll look to take the top spot

on the squad again and compete with the top players from every team the Wildcats play.

"We're happy to have her back next season," Hanson said. "She's an asset to this team."

Diana Ticu never quits, no matter what the score is.

## No change in intensity

Senior Erica Dobson found herself in a position she wasn't used to earlier this year when she was bumped down to two singles following the arrival of sophomore Christina Ruiz at Northville High School.

Dobson didn't flinch though. She kept her game at a high level and cut a swath through the two singles players that tried to get in her way.

"Erica did very well at two singles this year," said Woolfall. "She was a one singles player who was a lot better than most of the competition."

Dobson did what everyone thought she would do this year — she dominated. For her senior season she gave herself a gift of a 21-2 record at two singles and earned a regional tournament flight championship thanks to her play.

Where many players may have buckled under the pressure of being knocked out of their comfort zone, Dobson did what she had set out this year to do: She played with intensity and played well.

"Erica is a senior that we will miss," said Woolfall. "She has been a part of this program for several seasons and has contributed to our success."

With her ability and her determination, Dobson fits right in with the rest of HomeTown Newspapers' All-Area team.

## Familiar face

Some players are just comfortable as members of the All-Area squad. Novi junior Ayano Nakamura is one of them.

Last season, Nakamura earned the All-Area nod as a doubles partner with Laura Vaughn. This season she stands alone. And why wouldn't she? At two singles she took on and defeated 18 opponents and fell to just 11. She was the Kensington Valley Conference champion in her flight.

"Ayano had a great season," Hanson said. "She played the best tennis of her career and will be very good next year."

Novi has been blessed with scrappers at two singles for a number of years. This year they had a member of the singles squad that proved to challenge everyone who played her.

"Ayano didn't quit against any one, even if she was down, and showed that the match isn't over until its over," said Hanson. "She fought back and won a couple times this year."

## Doubles trouble

Northville seniors Jen Harkness and Amanda Darish are used to being a pair. They've played together for a number of years and this year they used their talents to take on the top doubles teams any squad could throw at them.

"These two have played well together," Woolfall said. "The toughest thing about doubles is trying to find players that work well together. There was never any doubt when it came to these two."

The duo didn't even flinch. They went 24-2 throughout the year and earned their conference and regional titles at the one doubles flight.

It's hard to say good-bye when a senior graduates, but when a doubles pair like Darish and Harkness graduate there's always the feeling of a void. It takes a special duo to fill such a role.

"They played as a team and were very compatible," said Woolfall. "Besides their success, their ability to get along with each other will be hard to replace. That's hard to find sometimes."

## Welcome back

Both Lauren Thomas and Emily Holt made all area last year as juniors for the Novi Wildcats. That year, they were on separate doubles teams. This year, they're together.

"Emily and Lauren were used to playing doubles and when they became a team this year it really worked out," said Hanson. "They played well together and had a lot of success."

It's no coincidence this duo was able to put together some impressive play to earn a Kensington Valley Conference title as well as a regional crown.

"Emily is a four-year player that won the conference every year," Hanson said. "Lauren has also been a big part of that success here in Novi."

Together, Holt and Thomas gathered a record of 23-8 against some very impressive

opponents. They even topped Ann Arbor Pioneer's top squad in the doubles flights — that alone makes a highlight moment for any tennis team.

## Was there any doubt?

Jackie Taylor and Shannon Farris played the best tennis of their careers this year. It showed with the way they rolled through their opponents and right onto the HomeTown All-Area tennis team.

"They played very well this year," Woolfall said. "You never know, which two players will make a good doubles team, which is why we change the line-up in the beginning of the year trying to find the right one. Jackie and Shannon fit well together."

The Northville seniors climbed to a 22-4 record this year and pounded out conference and regional titles without much standing in their way.

than the play of Novi seniors Amanda Cassidy and Kaylan Pustover — except for maybe how flashing their blonde hair was.

There aren't many doubles teams that go together as well as these two Wildcats. They bonded well, played even better together and no one seemed to have the recipe to beat them on a regular basis.

"It helps when you have a doubles team that plays together for more than one year," Hanson said. "Amanda and Kaylan were a good team. They complimented each other."

Pustover and Cassidy recorded a mark of 22-8 this year as they earned a Kensington Valley Conference title and were runner-ups to the regional crown.

"The hardest thing with seniors like those two is knowing they won't be back next year," Hanson said. "That experience and ability is going to be hard to replace."

## Dazzling duo

Few things are more dazzling

Sam Eggleston can be reached at (248) 349-1700, ext. 104 or at [seggleston@ht-homecomm.net](mailto:seggleston@ht-homecomm.net).

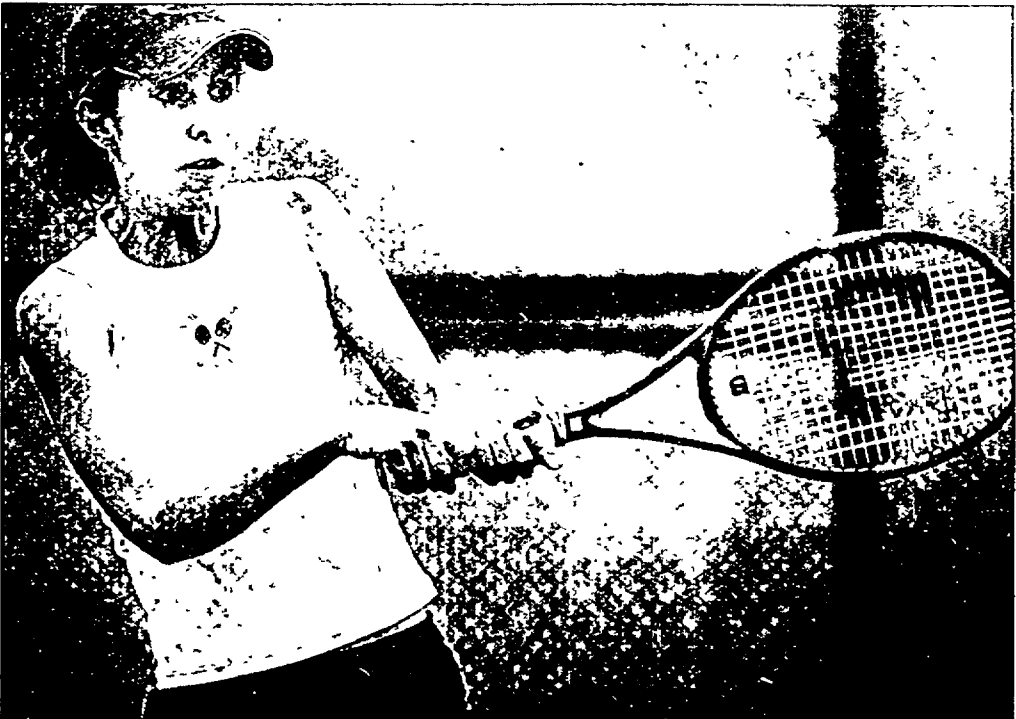

Northville's Christina Ruiz takes a swing at an incoming volley this season.

Photo by JOHN HEIDER/NORTHVILLE RECORD

**Rolling Stone** Peter Travers

**"'CLOSER' IS A TRIUMPH!"**

**Ebert@Roeper**  
**"TWO THUMBS WAY UP!"**

**"This film is mesmerizing."**  
ROGER EBERT, *Ebert & Roeper*

**"This is a masterpiece."**  
RICHARD ROEPER, *Ebert & Roeper*

JULIA ROBERTS JUDE LAW NATALIE PORTMAN CLIVE OWEN

**CLOSER**

If you believe in love at first sight, you never stop looking.

COLUMBIA PICTURES PRESENTS A MCKENZIE CROOKS FILM JULIA ROBERTS JUDE LAW NATALIE PORTMAN CLIVE OWEN "CLOSER" PRODUCED BY MARK PACE WRITTEN BY MICHAEL O'ROURKE DIRECTED BY MICHAEL O'ROURKE

CASTING BY PATRICK WARDEN COSTUME DESIGNER STEPHEN COLOMATTI MUSIC BY STEVE GOSWAMI EDITOR CELIA COSTAS EXECUTIVE PRODUCERS PATRICK WARDEN PRODUCED BY YEN-ING HOI PRODUCED BY JON CALLEY DARY BROWN

**R** RESTRICTED  
SOME MATERIAL MAY BE OFFENSIVE TO PARENTS  
PARENTS STRONGLY CAUTIONED  
SOME MATERIAL MAY BE OFFENSIVE TO CHILDREN  
STRONG LANGUAGE, DRUG USE, SMOKING, AND LANGUAGE

[sony.com/Closer](http://sony.com/Closer)

**STARTS FRIDAY, DECEMBER 3**

EMAGNE EASTON 734/721-3456	STAR THEATRES GRANT 585/791-3420	AMC LYONIA 28 734/542-9909	EMAGNE NOVI 248/219-FILM	UPTOWN PALLADIUM 12 248/644-FILM	M.R. SOUTHGATE 29 734/284-3456
----------------------------------	--	----------------------------------	--------------------------------	--	--------------------------------------

Sorry, No Passes Accepted For This Engagement.  
Check Theater Directories For Showtimes.



# Folino named HomeTown Player of the Year

By Sam Eggleston  
RECORD SPORTS WRITER

Basketball is a game of individuals who are asked to play as a team. Individuals can control a game. They can take it over and dominate it. Individuals can rise above the rest as stars.

HomeTown Newspapers are lucky. The coverage area includes some top-notch basketball players. Some are college prospects. All are impressive athletes.

## Folino earns top honors

Just what is it about Rachele Folino that makes her such a successful player? Is it her ability to drive with the ball? Her ability to shoot from beyond the three-point arc? Is it all of the above?

The answer is all of the above and then some. Folino, a junior at Novi High School, is being recruited by colleges

## Player of the Year

for a reason — she can do it all. She's the leading scorer on the Novi Wildcats basketball team, the leading rebounder and basically the leading lady. Folino is basketball. Basketball is Folino.

"We need more kids like that," said Novi coach Bill Kelp. "Basketball is her main sport. I've got no problems with players having more than one sport, but basketball is Rachele's main sport and it shows. It has really helped her on her path to success."

Currently, the stellar forward has netted 14 points and eight rebounds per game. She's poured in 22 here, 20 there. Assists? She does that too. Basically, she does it all.

Because of her pure talent, defenses were forced to adjust to Folino. They focused on her. They double teamed her most of the time and tripled teamed her when it became clear she wasn't going to be denied.

Such a force deserves recognition. The HomeTown Newspapers All-Area squad's Player of the Year nod is fitting.

"We play in one of the toughest defensive leagues around," said Kelp. "Everyone, especially in the KVC, works their game plan around stopping Rachele. For her to score 14 points a game and lead the league in scoring is a huge achievement."

The future is bright for this three-year varsity player. As a sophomore and a junior she took the lead on her team. She has made HomeTown Newspaper's All-Area Basketball team in the past and now she leads the list. She's on the all-conference squad again. Accolades just seem to pour in for her. It's not luck. It's hard work and it has paid off.

Her senior season promises to be one of the best at Novi in a long time.

"Next year we're going to go as far as Rachele Folino takes us," said Kelp. "We expect her to have a huge season. Hopefully it will be

one of her best and hopefully it leads her into an even more promising future of college basketball."

And what college wouldn't be lucky to get her? Quick on her feet, agile, aggressive and pretty darn talented — she's everything a recruit should be.

Folino can do it all. She dribbles, she shoots and, like always, she scores.

## Ms. Mustang

Ask anyone on the receiving end of it and they'll tell you being kicked by a horse is one of the most painful experiences ever. A Mustang, being untamed and unbridled, would most likely hurt even worse.

That's basically the same feeling an opposing team got when Northville senior Evonna Karchon was on fire. A threat both inside and out, Northville's leading scorer with 10.4 points per game was capable of controlling a game with her skill.

"She's an integral part of our team," said Northville coach Pete Wright. "She's so quick and so athletic she was able to surprise a lot of people."

Karchon was hardly just about offense. She netted 6.8 rebounds per game and snagged 3.1 steals thanks to her quick hands and court awareness.

For her abilities and impact on Northville's game, Karchon was given All-Western Division honors.

"On defense we asked her to guard both perimeter players and interiors players as well," said Wright. "We relied on her athletic ability to guard post players a lot bigger than her. Her athletic ability was also needed to guard on the perimeter."

Karchon, a three-year member of the varsity team, was key in Northville's largest upset of the year when they topped Plymouth Salem in their regular-season contest. Her season high was 22 points in a single game.

Her graduation will leave big shoes for Northville to fill.

"It's a big gap," said Wright. "She's so versatile and can play so many positions. It's always nice to have a player like that. She's going to be hard to replace."

## Point taken

Few guards can handle a basketball like Jessica Haggerty, a senior from Novi. When she received two fouls early in a game this year, someone in the stands mentioned that they hoped she wouldn't be taken out of the game because no one else could bring the ball up the court.

Though that statement is rather drastic, the truth is there is no guard that can bring the ball up the court at Novi quite as well as Haggerty.

"She is one of the best point guards I've ever coached," said Kelp, who has coached both boys and girls in 13 years in the game. "She's one of the most coachable kids I've ever had in my entire career."

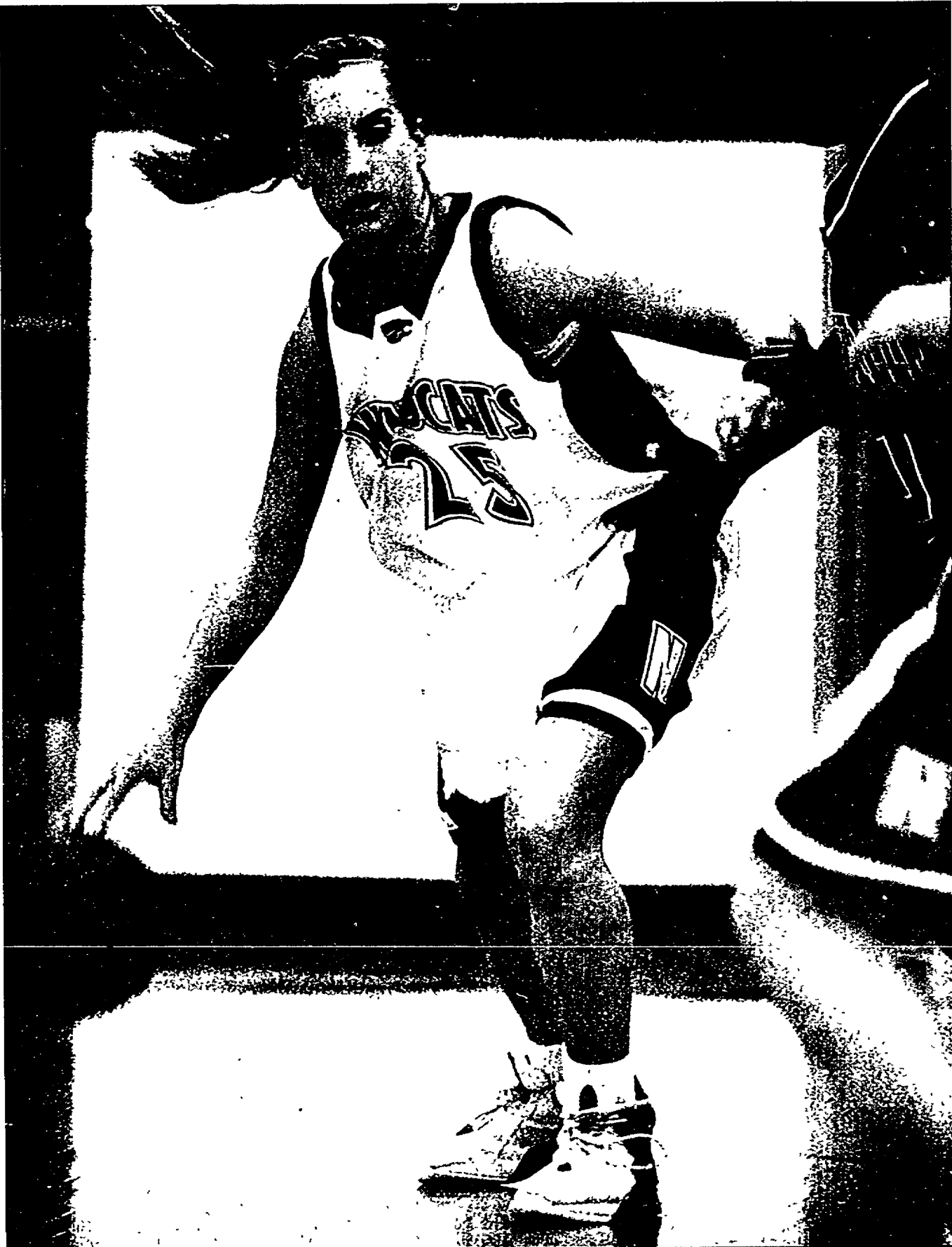

Photo by JOHN HEIDER/NORTHVILLE RECORD

Novi's Rachele Folino tries to bring the ball around the perimeter against Northville. She was named Player of the Year for HomeTown's All-Area team.

The other coaches in the Kensington Valley Conference must have noticed Haggerty's ability too. She was selected as a second-team All-Conference player this year.

With an average of six points per game and 3.5 rebounds, Haggerty's impact was felt by every team she played against. The senior also

snagged two assists a game and 1.5 steals.

"We match her up with the other team's best guard," said Kelp. "They're probably quicker than her, but she plays with them and quite often beats them. Why? Because of her heart and because of her desire. She works harder than the girls she plays against."

## Toney, Toney, Toney

She's agile, she's aggressive and she hates to lose.

Northville junior Simone Toney is a natural selection to the All-Area basketball team. She's quick off the dribble, can drive when she needs to and has been known to bury a few shots from downtown in three-point land as well.

"She's another versatile player for us," said Wright. "One of the benefits of Simone's ability is she's capable of playing the point. That adds an extra comfort when you have a second player that can bring the ball up for you."

Toney averaged 8.4 points per game this year, adding to her impressive totals from her sophomore season. Like last year, she was selected to the All-Western Division team thanks to her abilities and makes a repeat trip to the All-Area squad as well.

"Offensively, Simone can shoot from long range," said Wright. "She can take a person off the dribble, split defenders and finish strong at the rim."

Along with her impressive shooting abilities, Toney has been known to drive into the lane and kick it out to her teammates, gathering assists along the way. She also snagged 3.2 rebounds per contest and gobbled up 2.4 steals.

"She's a three-year varsity player that we're expecting to step up and take a leadership role next year," Wright said. "She's a very capable ball player that can get everyone else involved in the game."

## Give her the rock

If there's one thing that has held Novi junior Nicole Stephen back this year it's the fact that she's on a team with some very talented ball players.

Stephen, who earned a nod as an honorable mention selection in the Kensington Valley Conference this year, snagged 7.1 points per game with her inside presence

despite playing against some of the best the KVC has to offer.

"The KVC is just loaded with post players," said Kelp. "Look at the first-team All-KVC. Six of the eight players were in the post. Everyone is strong in the post in this league and I like to think we are too."

Though Stephen has been charged with the task of keeping out post players, she likes the KVC has not seen in a long time, she did her job and did it well. In addition to her impressive scoring totals, Stephen went up to capture 3.2 rebounds off the boards per game.

There's no denying the excitement

when Kelp talks about having her back for another stint next season.

"If she can make the jump like she did between her sophomore and junior year, she's going to be real key to our success," said Kelp. "When she scores over eight points a game we win 90 percent of the time. She's definitely one of our most improved players from last year to this year. Hopefully she can do it again."

Sam Eggleston can be reached at (248) 349-1700, ext. 104 or at seggleston@ht.homecomm.net.



Photo by JOHN HEIDER/NORTHVILLE RECORD

Mustang Evonna Karchon tries to get a shot off against Salem this year. Karchon is a senior this year.

**THE #1 COMEDY!**  
**SOAK IT UP AMERICA!**  
"NOW MORE THAN EVER, THE COUNTRY NEEDS SPONGEBOB SQUAREPANTS..."  
he answers the call, with a big-screen rendition of the nautical nonsense that has been delighting Nickelodeon viewers — including a great many grown-ups... The movie itself triumphs...  
A.O. SCOTT, The New York Times

**"VERY BOWDY AND AWFULLY COOL!"**  
JEFFREY M. ANDERSON, San Francisco Examiner

**THE SPONGEBOB SQUAREPANTS MOVIE**

PG PARENTAL GUIDANCE SUGGESTED  
SOME MATERIAL MAY BE INAPPROPRIATE FOR CHILDREN  
SOME MILD CRUDE HUMOR  
For rating reasons go to www.filmratings.com

**SpongeBobMovie.com**

AMC FORUM 30	NOW SHOWING	AMC LAUREL PARK
AMC LIVONIA 20	BIRMINGHAM PALLADIUM	EMAGINE CANTON
MJR SOUTHGATE 20	NOVI TOWN CTR.	PHOENIX AT BEL AIR CTR.
PHOENIX WEST RIVER	SHOWCASE DEARBORN	SHOWCASE WESTLAND
SHORES THEATRE	STAR FAIRLANE 21	STAR GRATIOT
STAR GREAT LAKES CROSSING	STAR JOHN R	STAR ROCHESTER
STAR SOUTHFIELD	STAR TAYLOR	UA COMMERCE STADIUM

CHECK MOVIE GUIDE OR CALL THEATRES FOR SHOWTIMES  
NO PURCHASE NECESSARY. SOME SEATING MAY BE RESERVED.

# HomeTown squad studded with local talent

By Sam Eggleston  
RECORD SPORTS WRITER

The Kensington Valley Conference is basically the best cross country conference in the state. The Western Lakes Activities Association, where the Northville Mustangs run, isn't far behind.

The All-Area team for the cross country squads represents some of the best runners Michigan has to offer. They are the cream of the crop. They are the best of the best.

## Moore please

There are few cross country runners that have the ability of Novi's Mark Moore.

He's fast, especially when it counts, and he doesn't buckle under pressure. Moore's top time this year was a 15:38, which he ran in the state finals meet for third place overall. He was the top runner in the Kensington Valley Conference at the state finals.

"Mark has been the spiritual leader of this senior class," said Novi coach Bob Smith. "He has been the guy that all the other athletes measure themselves against. Because of his knowledge and ability, he commanded respect."

Moore didn't just step up for one meet though. He did well all season. He took second overall in the Kensington Valley Conference finals meet as well as third in the Oakland County meet. In the regional, Moore was first overall.

"He has set the tone of the team and, fortunately, the tone has been positive and profound," Smith said.

The Novi senior is a returning member of the HomeTown Newspapers All-Area team, having been named to the squad last season as well. He was also named Athlete of the Year by his team.

## Leading the pack

As a sophomore, runners are supposed to sit back, put their legs up and relax. Why shouldn't they? Seniors will lead the team and so will juniors.

Well, that just doesn't sit well with Northville sophomore Jasen Turnbull.

Turnbull was the leader in Northville this year. He qualified for the state meet after finishing fifth in the region for All-Regional status.

"Jasen has a lot of potential,"

said Northville coach Chris Cronin earlier this season. "He can be a great runner if he puts in the time and is dedicated enough."

The Mustang sophomore's best time this year was 16:11 at the CC Classic, though he managed to earn the championship in the Western Division this season. He earned second-team All-Western Lakes Activities Association against some of the toughest competition the league has ever offered. At the highly competitive Michigan State University Invitational, Turnbull took 15th.

## Another strong finish

Novi is lucky to have such talented runners.

Their top two harriers in the above-mentioned Moore and senior Amol Huprikar helped make them one of the most competitive teams in Michigan. Why? Because you could never tell which would push the other to try that much harder.

"Amol is a very gifted runner," said Smith. "He has proven that when it counts the most."

Huprikar is a walking trophy case. He was the fourth-fastest Kensington Valley Conference runner in the state finals this season with his overall finish of eighth place in just 15:48. He earned All-KVC, All-Oakland County, All-Region and All-State honors this season.

"He has twice achieved All-State status in Division I cross country," said Smith. "Amol is also a student of the sport. He knew the competition, the curses, the strategies and the mental aspect of racing."

Quite frankly, any team would have been drooling over having such a high caliber runner step up and be their top man.

"He was very active in guiding our younger athletes in the finer points of meet preparation," Smith said.

The All-Area team is just another accolade Huprikar can add to his resume. It marks a return trip for him to the squad, having made it last season as a junior.

## Spencer for hire

A strong cross country team has strong finishers who may not be the top runner on the team but always does what's best for his squad.

Spencer Ornes, a senior at Novi High School, is one of those runners. His best time this

season was a 16:42 and he came through for his team when they needed it the most.

"Spencer was 100-percent committed to our program," said Smith. "He came into the season fully prepared to make his senior year his best. He accomplished that goal and then some."

In the Kensington Valley Conference meet, against some of the toughest runners Michigan has to offer, Ornes pushed his way into the top flight of runners and came away in 10th place to help Novi secure the championship. In the regional, he ran one of his best races of the year, finishing seventh to help Novi earn that title too.

"As evidence of his drive to excellence, Spencer ran over 700 miles during this past summer leading up to the season," Smith noted.

He also earned an All-Oakland County nod this season to add to his All-Area honors. Ornes deserves his accolades. Few runners work as hard as he does.

## Career performances

Novi senior Justin Namm came into this season knowing if he put up his best performances he could hang with some of the toughest runners around — his peers in the Kensington Valley Conference.

Namm did that and a whole lot more in his final stint as a harrier.

"Justin knew how to race and train," Smith said. "It was not unusual for Justin to be at the front of the pack during our practice runs. He stayed focused all year."

In his senior season, Namm collected a career-best run of 16:38 in the state finals. He also earned All-Oakland County honors this year thanks to his impressive running.

"Justin knew the correlation between quality practices and quality racing," said Smith.

In the KVC meet, he was key in Novi's overall victory for the conference title. He edged past some tightly-packed runners and came in 11th to help secure the crown. He also notched an eighth-place finish in the regional meet and helped Novi to the title.

In the state meet Namm kicked out his best performance, finishing 55th overall.

Sam Eggleston can be reached at (248) 349-1700, ext. 104 or at [seggleston@ht.homecomm.net](mailto:seggleston@ht.homecomm.net).

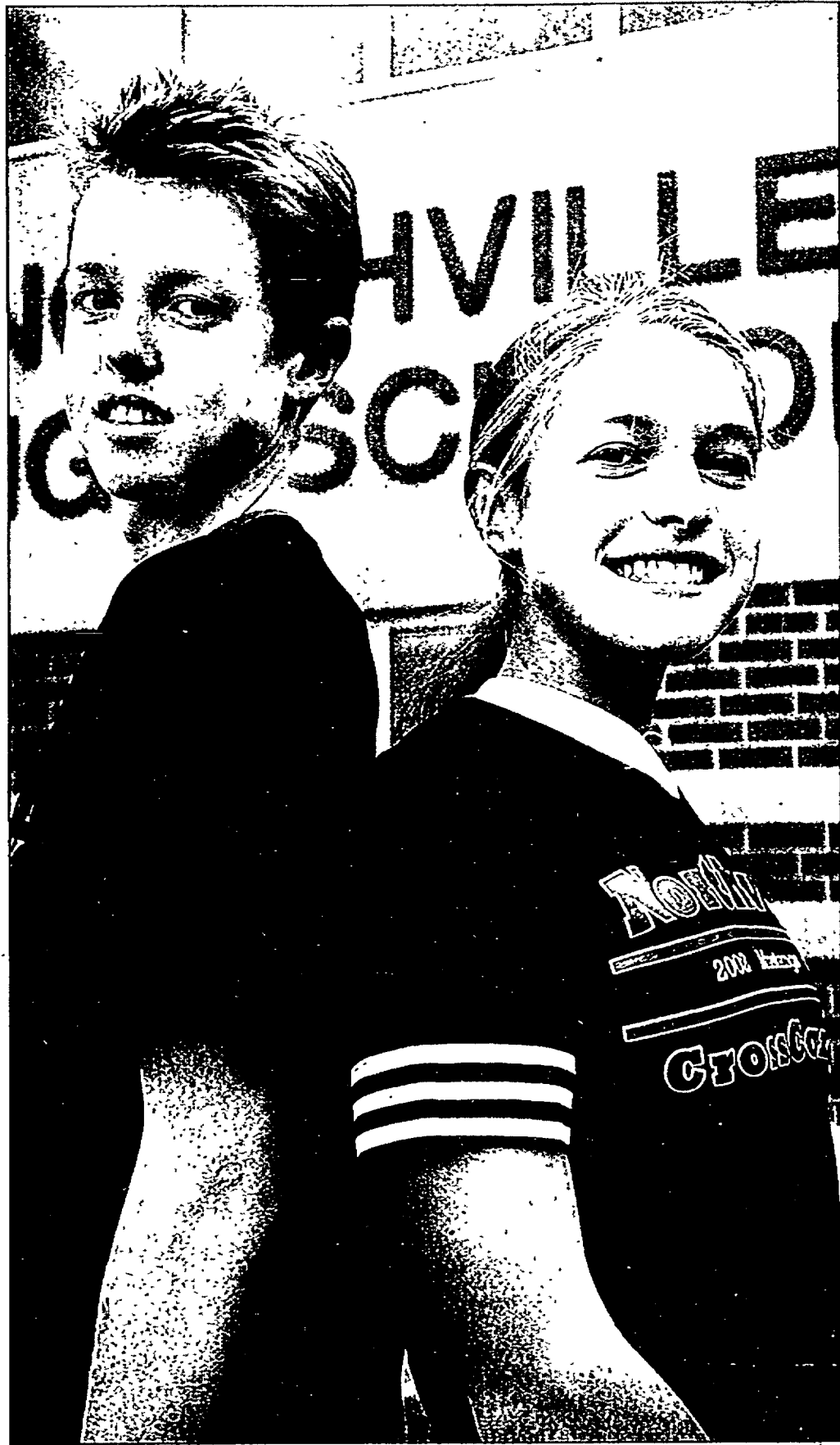

Photo by JOHN HEIDER/NORTHVILLE RECORD

Mustangs Jasen Turnbull and Liz Hrivnak were both selected to this season's squad for All-Area.

# Girls squad full of talent

By Sam Eggleston  
RECORD SPORTS WRITER

In the world of cross country, girls reign supreme. The races are usually tighter for the most part and the rise and fall of athletes is usually much more dramatic.

This year didn't disappoint. Close races abounded and some of the top teams didn't even qualify for the state finals.

It was a great year for cross country and a great year to select one of the most impressive HomeTown Newspapers' All-Area teams to date.

## Record-setting performance

Northville senior Liz Hrivnak is no stranger to being competitive. Sure, she's quiet and borders on being shy, but an animal is unleashed when she runs. Hrivnak hates to lose. It shows in her performances.

"Over the past three seasons Liz has been a true leader," said Northville coach Nancy Smith. "She is always so dedicated and determined each and every day."

Though Hrivnak would never let you know it.

"She was always so humble in her achievements, never once letting it affect her or hinder her from striving for more," said Smith.

This year Hrivnak went above and beyond what was expected of her. She broke the school record with a time of 18:53 and has now set the mark even higher than before.

"Liz raised the bar this year for future runners by setting the school record at 18:53, a mark that will truly push others to have to train harder to achieve and surpass this incredible performance," said Smith.

She earned All-Division honors with an overall victory at the Western Division meet and was an All-Conference runner. She has been the team's MVP for the past two seasons. Hrivnak makes her second appearance on the All-Area squad to go with her many accolades this year and last.

"Liz will be greatly missed next season as she has been an

asset to the team over the last three years and a true leader," Smith said. "Liz is one of the best runners I have ever coached and one who will stay on the record board for years to come."

Beyond being a great runner, Hrivnak is also one of the nicest people to have ever graced an All-Area squad. She's polite, she's genuine and she's modest. Her shoes will be the biggest on this squad to fill next season. There's more to her than just running.

## Patti cake

Many people might not know it by looking at her, but Novi senior Patti Ramos sure can cook. In fact, last year her Chocolate Chip Cookie Pie won an award in the Novi News and Northville Record pie contest — and they say never trust a skinny cook!

It's obvious that her recipes are successful outside of the kitchen as well. Ramos has the right ingredients to make herself one of the top runners in Michigan.

"One of my most enjoyable coaching experiences," said Norm Norgren, the Novi coach. "From the time she was a freshman to now she has matured into a fine young lady and a super athlete."

This season, Ramos racked up the awards. Not only has she been selected to the HomeTown All-Area squad yet again, she was also an All-Oakland County runner, All-KVC and All-Regional as well. She's a fourth-year runner at Novi and this season helped lead her team to the state finals where she finished 40th overall.

"Hard work, dedication and friendly," Norgren said. "She's also a super student with a 4.0 GPA."

## Welcome aboard

It was inevitable. Northville senior Kate McClymont has skirted on the edge of the All-Area team in the past and she has finally earned a selection.

And why not? She ran in the state meet this year with a time of 19:42 for 63rd place overall.

She was an All-Western Division runner, second team All-WLAA and a regional medalist.

"Over the last four years, Kate has grown into an incredible runner, always striving to become better," Smith said. "Kate was a true leader this season. Her dedication and determination through many roadblocks from injury never stopped her pursuit to be the best runner she could be."

She's more than just a good runner and a pretty smile though. McClymont has brains to boot, which explains why she was selected as an Academic All-State runner as well.

McClymont will leave a void next year thanks to her graduation. Not only will she be missed by her teammates and her coach, but also by the newspaper that covered her on a weekly basis.

"Kate has been a constant contributor and a top five runner all four seasons on the team," Smith said. "She will be greatly missed next season and her leadership and caring attitude will be missed by the underclassmen."

There aren't many athletes like McClymont, both on and off the cross country course.

## First-time runner

It's hard to imagine what numbers could have been produced by Novi senior Katie Shannon had she run cross country for four years instead of just one.

One thing doesn't have to be pondered though — she made the best out of her single season.

"Only a first year runner for a senior, but what a year," Norgren said. "The first day of practice she asked how she could help the team make the state finals."

Shannon earned all kinds of honors this season above and beyond what was expected of her. She earned All-Oakland County and All-KVC to go with her All-Area selection. She missed All-Regional by just two

Continued on B5

## "Hunter's Trophy Case"

Spotlight your

"PRIZE"

in this photo showcase  
The Hunt Is On!



Congratulations Cy Spiegel  
on the stalk of a lifetime.  
Nov 23, 2004.

Sponsored  
by:



Shooters Service  
New & Used Guns  
Full Archery Department  
Gunsmithing  
CBL Classes  
Buy - Sell - Trade  
2449 E. Mile  
at Middlebelt - Livonia  
866-525-1130

Mail picture along with payment of \$10.00 (photo processing fee) to:  
HomeTown Newspapers, P.O. Box 230P, Howell, MI 48844  
Attn: Leslie Meredith, 517-548-7392  
Email: [lm Meredith@ht.homecomm.net](mailto:lm Meredith@ht.homecomm.net) • Fax: 248-437-9460

## CLIP & MAIL

Caption under picture to read (20 words or less)

If you would like your photo returned, please include a self-addressed, stamped envelope.

Charge to my account: \_\_\_\_\_

Exp: \_\_\_\_\_

Signature: \_\_\_\_\_

Phone#: (\_\_\_\_\_) \_\_\_\_\_



# Hannah leads charge as Player of the Year

By Sam Eggleston  
RECORD SPORTS WRITER

Soccer. It's all about the team. Without every person on the field, from the top scoring forward to the stone walling goalie, no one would be able to earn a victory.

The teams of Novi and Northville did their fare, the Mustangs were ranked first in the state and the Wildcats made a run for the district title against a tough Livonia Stevenson squad.

## The king of kings

Is there anything James Hannah can't do? Well, it's apparent the Northville senior forward can't stop being good, so add that to the very small list.

Hannah is a powerhouse. He always has been. He always will be.

"James can control a game," said Henry Klimes earlier this year. "The other team is forced to adjust to him. They have to put their best player against him and they have to be ready to stop him. That makes us more of a threat."

The senior didn't stop at just being one of the best soccer players to put on a uniform for Northville High School. He also made a point of showing he was multi-faceted this year.

"James is a great kid that impresses me by being able to play two sports," Northville football coach Clint Alexander said. "That's awe-inspiring."

Hannah scored 25 goals this season and had 10 assists. He is first on the all-time Northville list for goals and third for assists in a single season.

Dedication and determination helped make this year's HomeTown Newspapers All-Area Player of the Year the leading scorer despite missing two games from a red card he took against Salem and an injury that soon followed.

With an ankle injury that was expected to keep him out of play for up to a month, Hannah showed his grit by coming back merely a week later.

"They said it could take up to that long," Hannah later said. "I wasn't going to wait."

"But it's going to be a long, long wait for Northville soccer fans. Who knows the next time a player of Hannah's caliber will come through. Maybe never."

## Defensive pressure

No one applies defensive pressure like Trey Love, a junior for the Novi Wildcats. He is asked to stop some of the best players in the state and has made a point of

doing the task well. "He is probably the best one-on-one defender in the state," said Novi coach Brian O'Leary. "He held the number one player, James Hannah, without a shot on goal and the number two player, Jordan Fylenenko, without a shot on goal."

Love was selected as an All-KVC, All-District, All-Region and Third-Team All-State player. He makes his second appearance on the HomeTown Newspaper's All-Area team.

"It is because of Trey that we play man-to-man defense," O'Leary said. "He can always eliminate the other teams' best offensive player."

## One goal in mind

Steve Besk is one of the best goalies in the state.

He plays against some of the best teams. He plays with some of the best players. Against all of them he has shown himself to be a stellar goalie.

This will mark Besk's fourth-straight nod to the HomeTown All-Area team. And why not? This year he helped his team to a 19-2-1 record and a number one ranking in the state. He recorded 11 shutouts this season. He has 22 shutouts in his career.

This season he had 72 saves and earned 17 victories on the year.

"We can always rely on Steve," Klimes said. "When he's playing we don't worry. He's always on his game and he's always ready to play."

This season, Besk was selected to the All-District, All-Region and Second-Team All-State teams. He is being actively recruited by a number of colleges.

## Well done

If one thing is certain in life, it's A.W. Stanek, a junior Novi midfielder, puts every ounce of energy into his game.

"He is our best offensive player, which is rare for a midfielder," said O'Leary. "He is also our best player in the air."

This season, Stanek collected 10 goals and five assists. He was named All-Conference, All-District, All-Region and Honorable Mention All-State.

## The future is now

Mike Cornelius, a Northville junior forward, has a bright future. Not only was he the second-leading scorer for the Mustangs this year he was also one of the most highly recognized players on the team.

"Mike has been an asset this year," Klimes said. "When defenses focus on James we have Mike ready to score."

Cornelius earned Third-Team

All-State recognition this season.

This season, Cornelius scored 14 goals and collected a team-leading 17 assists. He is first all-time for assists for Northville in a single season.

## The right ingredient

Neil Kocan, a senior from Novi, was asked to move from the midfield to defense this season. He did and the Novi Wildcats were much better because of it.

"In the first few games we were having lots of trouble shutting the other team down and they were getting lots of shots on goal and way too many quality scoring chances," said O'Leary. "Then I switched Neil from midfield to sweeper and we instantly became a team that was difficult to score on and gave up very few quality scoring chances. He was the most important piece of our team's success."

## No glory

If there's one thing about soccer and defensive players, their names are rarely mentioned outside of their circle of fans.

Defenders do it all. They get assists, they stop plays and they keep the score tilted in the favor of their team.

Northville junior Mike Blasius doesn't mind the fact that he doesn't get any attention. He just keeps playing.

"The defense doesn't get the credit it deserves," Klimes said.

This season, Blasius did get his nods though: He was selected as an Honorable Mention All-State player.

## The hammer

One player was actively pursued to play a sport other than soccer this year when the varsity football team practically begged him to play for them too.

Scott Hammerle, a senior defender for Northville, didn't bite though. And why would he? He's one of the best defenders around in the game he loves.

"Scott is a big part of our team," Klimes said. "He has a lot of experience and is a leader for us."

## Double trouble

Can't Mike Kelleher, a senior midfielder for the Northville Mustangs, stay off our lists? This is the second year in a row he has made All-Area and this year he also earned a spot of the All-Area football team as well.

What makes him so special? His undying need to be the best, of course.

"Mike never quits," Klimes said. "Even though he plays football too he never complains

about being tired. He just keeps going. He gets a little banged up now and then, which worries me, but he works through it."

## Got milk?

Phil Yutzy had a rough season. He only played a fraction of the games this year after breaking his foot in August. The result? He had to push himself back into action.

He used the help of a half a gallon of milk a day.

"Just having a Phil on the field makes a difference," said Klimes. "He's a leader for us. Having him off the field has been tough on all of us."

There will always be if, and or buts when it comes to Yutzy's seniors season. Though he didn't have much in the way of numbers this year, he is ranked on the all-time assists and points board for the Mustangs.

No matter what his numbers were, Yutzy earned a place on the All-Area team. Few others could have pushed themselves to come back and salvage their senior year.

Sam Eggleston can be reached at (248) 349-1700, ext. 104 or at seggleston@ht.homecomm.net.



Mustang Scott Hammerle kicks a ball during warmups before Northville's game against Salem.

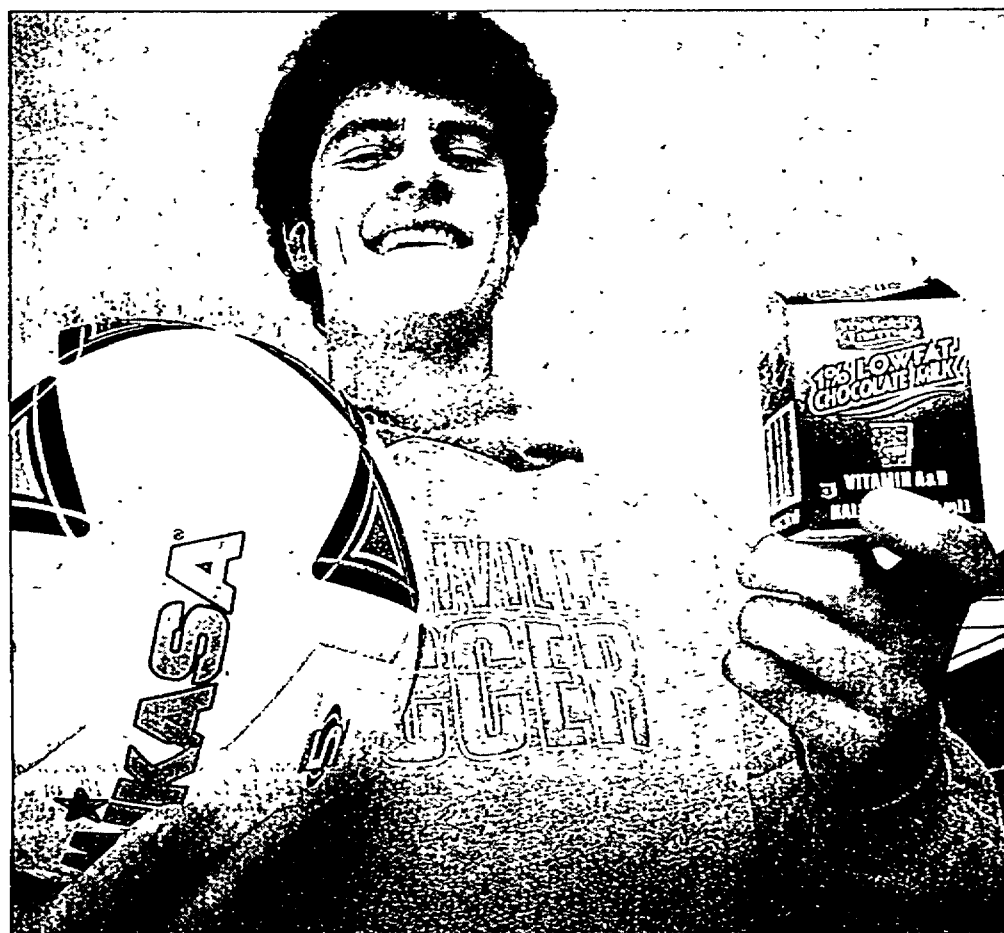

Mustang soccer player Phil Yutzy had been drinking about a half a gallon of milk a day to speed the healing of a broken bone in his foot so he could get back to his playoff-bound team. Yutzy was selected to the All-Area squad this season.

# Girl harriers full of talent

Continued from B4

slots this season with her 17th-place finish that helped Novi to the state finals.

"She took every bit of coaching and produced a super year for the team and herself," Norgren said. "She has a grade-point average of 3.5."

The Novi harrier did well at the state finals, especially considering the course conditions were slippery and wet and it was her first appearance there. She finished 78th overall.

## Smitten over Smetana

What's not to love about Northville junior Bryn Smetana? She's intelligent, she's fun to talk to and she's pretty darn talented when it comes to athletics.

That's why when it came time to pick the All-Area team her name was one of them at the top of the list.

"Bryn's desire to improve this season was shown throughout the entire year," said Smith. "Her dedication to off-season running and attending two running camps made her a stronger runner and someone who the team could count on."

Smetana was a state qualifier this year, finishing 148th overall in Division I with a time of 20:39. The time was well-off her season-best mark of 19:58 thanks to the uncooperative running conditions at the finals.

Smetana was also an All-Western Division runner and a second-team All-Conference harrier as well. She was a

regional medalist with a 15th-place finish.

Next year, Smetana will be expected to step up once again for her team.

"Next season Bryn will serve as one of my captains and her dedication and leadership skills will help guide a talented team in 2005," Smith said.

## One veteran Wildcat

As a sophomore, Novi's Meghan Bannatz was selected to the All-Area cross country team. This year, as a junior, she has been selected again.

Why? Because she never quits improving and competing.

"The team voted Meghan the 'Practice Overachiever,'" Norgren said. "She works hard at all times, both in season and out."

Bannatz was one of the top runners on her team this year who never quits working. When she is done practicing, she practices some more. Right when you think she's at her limit, she surprises everyone.

Bannatz was an All-Regional runner this season and one that helped her team to the state finals. As a junior, she finished 64th overall.

"Meghan is totally dedicated to all phases of the sport," Norgren said. "She is liked by all of her teammates. She has a 4.0 GPA."

Smart and speedy? Sounds like the right combination for another All-Area nod next year.

Sam Eggleston can be reached at (248) 349-1700, ext. 104 or at seggleston@ht.homecomm.net.



Patti Ramos of Novi was selected to another All-Area team. She's a senior this year.

Muscular Dystrophy Association  
Jerry Lewis, National Chairman  
1-800-572-1717  
www.mdausa.org

**DEC. 3RD & 4TH**  
FOR TICKETS CALL 734-453-8400

**PLYMOUTH WHALERS** VS **KITCHENER RANGERS**

MISSISSAUGA ICE DOGS December 3rd  
KITCHENER RANGERS December 4th

FRI. DEC. 3RD, 7:30PM Family Value Night  
D.A.R.E./TEAM

SAT. DEC. 4TH, 7:30PM Family Value Night

COMPUWARE SPORTS ARENA  
14900 BECK ROAD PLYMOUTH TWP, MI 48170  
www.plymouthwhalers.com



# Football team full of stellar athletes

By Sam Eggleston  
RECORD SPORTS WRITER

What is it about football in this area? This season, both teams were extremely competitive and both teams had staggering season statistics.

Football is alive and well in Novi and Northville. Just come to the games on a Friday night in the fall and you'll be the first to agree.

## OFFENSE

Offense is key in any game. Whether a team runs the ball or passes it, they have to put points up on the board in order to win. Novi did that just fine, breaking long runs throughout the season for their scores. Northville was the second-highest scoring team in school history this year.

## The gridiron king

What can't Kevin Cislo do? The Novi senior quarterback has shown time and time again that if you want to beat them you have to shut him down. This season he racked up 892 yards with his rushing attack, scoring 14 touchdowns along the way, and passed for 514 and eight more scoring strikes.

There's a reason he's the offensive player of the year. He was the offensive player of the year for the Kensington Valley Conference too and was because of the same reason. He will not be shut down. He will not be denied. He will score on you and if given the chance, he will beat you.

## Offensive Player of the Year

"We were lucky to have an athlete like Kevin to run our offense and lead our team this year," said Novi coach Tab Kellepourey. "He's an outstanding athlete. He makes good reads and keeps the offense under control."

The scary thing about a player like Cislo is the fact that football is the sports he's second best at. Baseball is his primary selection. That's the sport he decided to play at the University of Michigan.

"That just goes to show what kind of athlete he is," said Kellepourey.

Cislo was also a defensive back for the Wildcats. He pulled down five interceptions this year. Oh yeah, and he was the punter too, collecting 1,443 yards in total punting yards on 37 kicks for a 39-yard average. His long was 66 yards.

## He's only a junior?

Aren't stellar seasons supposed to be reserved for seniors? Don't tell that to junior Charlie Thomas, Northville's quarterback.

"We allowed Charlie to get in situations, make plays and force things to happen on offense," said Clint Alexander. "We had a lot of trust in his ability to read defenses. He's real smart, real calm and a great leader. You could never tell he was a junior as far as leadership on the field."

The scary thing about a player like Thomas is the fact that football is the sports he's second best at. Baseball is his primary selection. That's the sport he decided to play at the University of Michigan.

"That just goes to show what kind of athlete he is," said Kellepourey.

Cislo was also a defensive back for the Wildcats. He pulled down five interceptions this year. Oh yeah, and he was the punter too, collecting 1,443 yards in total punting yards on 37 kicks for a 39-yard average. His long was 66 yards.

## Like trying to grab air

Trying to bring down Novi senior runningback Jarrell Woods is like trying to tackle air — it isn't easy. The speedy tailback was able to collect 783 yards rushing with 14

touchdowns this season with the constant ground game the Wildcats have to offer.

"Jarrell helped make our offense come together this season," said Kellepourey. "To have an option game capable of producing yards and touchdowns you have to have more than a single threat in the backfield. Jarrell was another threat for us."

Against Northville he was devastating, taking the opening offensive play all the way for a score despite being hit by five players along the way. The Mustangs weren't alone in the club though — Woods was known to decimate plenty of defenses.

"He's an outstanding football player," Kellepourey said. "It has been a lot of fun coaching him."

He was selected as an All-KVC player this season as well.

## Slippery Stilec

Northville senior Mac Stilec is one slippery little son of a gun. He can dart in and out of tackles and then break a run up-field.

Stilec did it more than one opponent this year, as his numbers can testify. He ran for 1,030 yards and scored 14 touchdowns this season.

"Obviously, Mac is a great athlete and an asset to this team," Alexander said. "But aside from what he was able to produce on the field this year his off-season commitment was unbelievable. He's a tremendous leader and a lead-by-example kind of guy."

This season, he was picked as an All-WLAA player despite a hamstring injury that limited his action for much of the regular season.

"He worked hard to rehab that injury this year," Alexander said. "It was critical for us to get him back on the field. He's one of the most talented kids I've ever met, but he's humble. I've never seen him be cocky and I've never heard him bragging about himself."

## Go long!

If there is one thing Northville did well this season, it was pass the football. And on the receiving end? None other than two-time All-Area selection Mike Jameson, a senior.

"I felt like he was the key to our offense," said Alexander. "We used him to unbalance the field. When defenses gave him a lot of attention, which they seemed to do a lot, we sent things to the other side of the field. We could not have been successful without Mike Jameson."

Jameson has hands like glue. He rarely ever drops a pass, even if it's when he's being pummeled during a cross route through the middle of the field. He's going to hold on.

"He's a big play receiver," Alexander said. "Against John Glenn he had 162 yards receiving. He nearly single handedly beat them."

This season, the speedy receiver collected 643 yards of offense and put the ball in the endzone four times for Northville. He earned All-Western Lakes Activities Association honors this year.

## Center of attention

Ryan Pritchard is finally a senior. Ask any coach who has had a team play against this senior offensive center and all of them will be quick to say they are relieved. This All-KVC special teams captain and all-around tough cookie has been stifling blitzes and defensive linemen as a three-year starter at Novi.

Pritchard also played his fair share of defense too. He collected 32 tackles and a sack this year as a down lineman.

"Beyond being a great lineman in our program, Ryan is a great kid," Kellepourey said. "He's extremely intelligent, which helped us on the field. We knew with Ryan in there it was like having another set of coaches' eyes out there for us."

He's done his job well, which is one of the reasons he has had interest from some fairly big names of

college football. Besides being a tough cookie, Pritchard is a smart one too, which is why his main interest is Princeton for his choice of higher education and a little football too.

"I'd like to see Ryan play at the college level," said Kellepourey. "I think it would be a good fit for him."

## Just plain nasty

There's a word the Northville Mustangs coaching staff likes to use: nasty. It's the perfect word to describe senior offensive lineman J.D. Gerblick.

"He's the most competitive kid on our offensive line," said Alexander. "He did what we wanted him to do on basically every play. He was always determined to make sure his guy didn't make the tackle."

No, he's not a dirty player. He's just nasty. He puts players on their backs, beats them up and then invites them back for a little more. Thanks to blocking like this, Northville had a rushing average of nearly seven yards per carry.

Gerblick was an All-Western Division selection this year.

"He has great feet and he's a great technician," Alexander said. "His determination and his skill made him capable of beating the guy in front of him. I'm certain he can play somewhere. He's so relentless, so determined that he's be an asset to any college that took him."

## The big boy

Mark Yassay, a senior offensive lineman at Northville, is no small fellow. He towers over nearly everyone around him, has muscles trying to tear through his clothing and can easily be characterized as a "quiet giant."

"He's a poster boy for weight lifting," Alexander said. "His off-season conditioning helped him develop into a true athlete. He's such a physically devastating blocker. He will drive a guy so far up the field that it makes a natural hole for our running-backs."

This giant, however, is one you really don't want to wake up. When you do it usually ends in a defensive player buried on the turf on his back.

"He's drive a guy and then just pancake him," Alexander noted. "But even without that ability he was an asset to us. He's an outstanding young man with all the keys to success. He helped bring the team together, both consciously and indirectly, and that made the rest of the team better."

Yassay's prowess on the field was noted by the coaches who put a player up against him. He was selected as an All-WLAA player this year.

## DEFENSE

Offense gets the glory but defense wins championships. Just ask the Novi Wildcats, who were KVC champs for the second-straight season. They were also District champs for their third year in a row.

## What a snag!

Sean Costello, a senior defensive lineman for the Novi Wildcats, is big and he's quick. He'll bull over a tackle, get in a quarterback's face and punish him.

That's Costello's job. But his job isn't to grab an interception like he did this year thanks to some trickery by defensive coaches Jeff Burnside and David Hartman.

"Sean was part of a defense that did an outstanding job for us this season," Kellepourey said. "He did what we asked him to do. He's aggressive and he's determined. The interception came from a stunt we ran that game that enabled him to have that opportunity."

Costello did more than just snag a simple interception. He recorded 46 tackles and 3.5 sacks this year on his way to an All-KVC selection.

## Just try and stop him

A lot of people thought they could just put a body on Northville senior Joe Prain and stop him from getting through the offensive line. Not so. It takes more than a single block to slow this All-Area defensive lineman.

"He was a captain for us and I felt he was the rock on our defensive line," Alexander said. "He was an anchor for us on the edge and a heady player that's field smart."

Prain collected a whopping 49 tackles this year and earned four sacks against some of the best linemen in the state. Thanks to his efforts he was awarded an All-Western Division nod.

"He led the team in sacks and tackles for a loss," Alexander said. "He's a great player with great awareness. You couldn't fool him or trick him. He was always in the right place at the right time."

## A welcome selection

Novi senior linebacker Robbie Carter is comfortable on the All-Area list. He's one of the returners on the team this season.

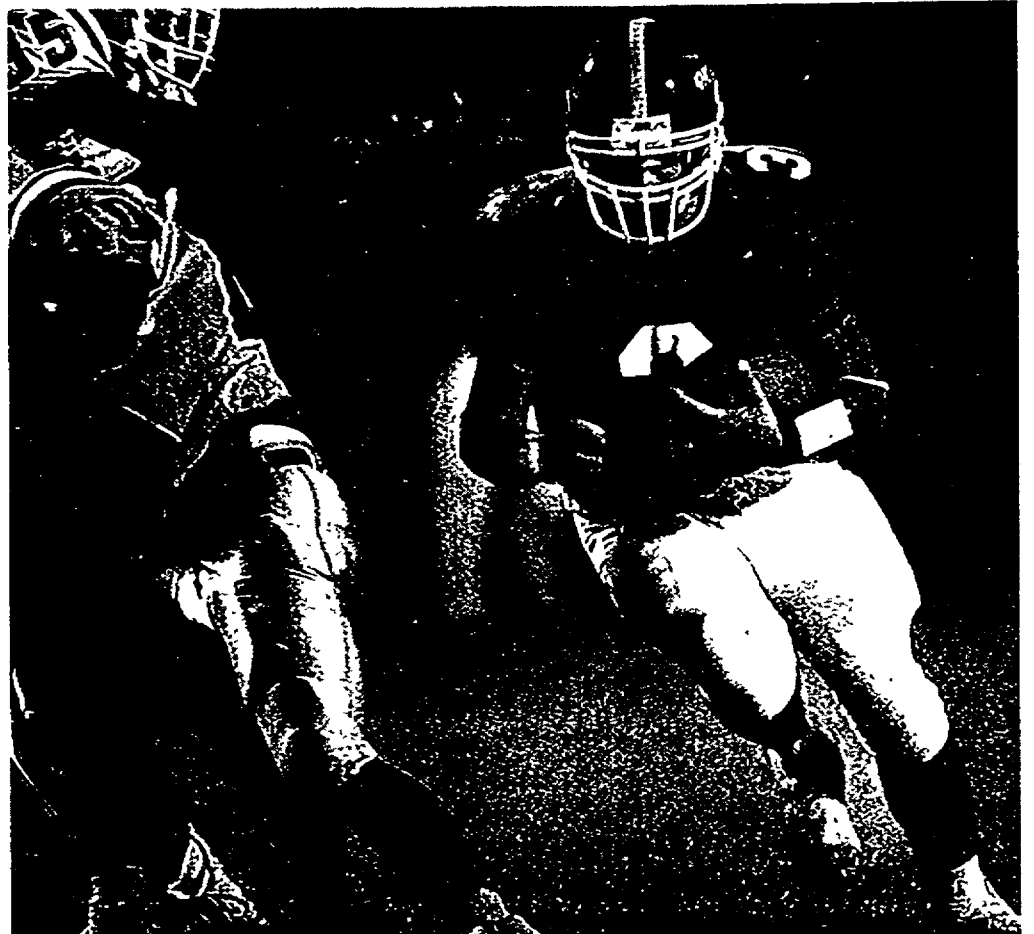

Mustang Charlie Thomas, right, eludes the grasp of one Walled Lake lineman. Thomas made the All-Area team as a junior this year.

The intense Wildcat makes hits like no one else, crushing opponents into the ground. He's also the team's hardest hitter, which helped him deliver the punishing hits to those who tried to emulate him during a game.

"Rob was never satisfied," Kellepourey said. "He always wanted to do better and was his own worst critic. He knew what he was doing out there and the result was often some of our biggest hits this season."

Carter collected an applaud-worthy 73 tackles this year to lead the Wildcats along with 2.5 sacks. He had four forced fumbles, recovered one and had an interception this year.

"He kept his head in the game and was involved on nearly every play," said Kellepourey. "We're going to miss him on our team next year. He's going to be very hard to replace."

Novi's leading tackler was an All-KVC selection this year.

## Back again?

Josh Woods, a senior linebacker for the Wildcats, is another returning face on the HomeTown Newspapers All-Area team. He's about as tough as they get too, which is why he keeps getting named to the squad.

"Josh is an outstanding linebacker," Kellepourey said. "He could read a play very well, which enabled him to be where he needed to be to make a big play. We knew he would get the job done for us and were always confident when he was in the game."

This year Woods earned 71.5 tackles while punching through the offensive backfield for three sacks. He forced three fumbles and pulled in one interception during his All-KVC campaign.

## A bird in the hand...

Rick Birdsall is a diamond in the rough.

This Northville senior linebacker did whatever it took to be an asset to his team and his coaches. He played defense, studying film, learning every play and recording 45 tackles along the way. As with a punter he helped his team with a 34-yard average on 33 punts with a total of 1,137 yards. His long was 66.

More importantly than anything else, Birdsall was a leader. He rallied the troops, led the charge and fought with every ounce of his energy every single game. That's the kind of play the HomeTown Newspapers All-Area team was built on.

"He was the coach of the defense, basically," Alexander said. "He lined everyone up and made sure they were where they were supposed to be. It wasn't until he had a concussion and had to come out of the game that we realized just how important he was."

When he returned to the line-up, Alexander said he breathed a sigh of relief.

"He was in the right place at the right time," Alexander said. "Beyond what he did on the field, Rick was also ready for every opponent. He studied them and their tendencies and when he recognized what they were doing he let the others know. His efforts made people around him better."

## Two sport All-Area selection

Playing two sports in a single season is amazing. The time constraints and the physical demands are enough to consider it a feat.

Two excel at both sports? To make HomeTown Newspapers All-Area team for football and soccer?

That's awe-inspiring. "Our two-sport phenom," said Alexander. "He was our team's hardest hitter. You wouldn't have guessed that, but he had great closing speed and prowls the field like a predator. He was always looking for people to hit and usually found people to go after."

Mike Kelleher, a senior defensive back for Northville, is definitely that. To watch him play in either sport is a moment of awe.

"He has such a tremendous work ethic," Alexander said. "I was impressed that he could play two sports at one time and go full out the whole time. He never complained that he was tired or injured. He's a very impressive young man."

Kelleher led the Mustangs in tackles this season, scooping up 55 in his final season. He also recorded a single interception.

## It's a mystery

How does the best defensive back in the Western Lakes Activities Association not get an All-WLAA nod? The only answer seems to be politics.

"He's an unselish player that moved from linebacker to free safety for us early in the year," said Alexander. "He was a physical presence back there and an answer for us when we needed one."

Northville junior David Bandy did everything he needed to do for an all-conference selection. He collected 53.5 tackles to account for the second-most on his team and snagged six interceptions — ranking as one of the top in school history for the statistic.

"His interceptions were usually unbelievable catches too and not just passes tossed over some kid's head," Alexander said. "We're excited to have this kid back, that's for sure."

Bandy may have been looked over for All-WLAA selection, but he fits in perfectly with HomeTown's All-Area squad.

## One tough cookie

Novi junior John Favorite is one tough cookie. He doesn't flinch away from a hit and he doesn't hesitate to level a ball carrier.

Maybe it's all the lacrosse he plays. Getting hit with sticks all day may have toughened his hide a little.

"Favorite is definitely a very tough player," Kellepourey said. "It didn't matter how big the player was coming at him because he never backed down. Having a player like that as a defensive back helped make us stronger in any situation."

Favorite collected 47.5 tackles this season, snuck in for a sack and earned three interceptions. His time in the defensive backfield was well spent as he earned All-KVC honors this year.

## SPECIAL TEAMS

Sometimes it comes down to a little kick. Thankfully, Novi and Northville never overlooked the importance of a good special teams squad this year.

## It's up and it's good!

Evian Corbeil, a Northville junior, never made a fuss about anything. Even when newspapers other than those run by HomeTown made the mistake of giving his field goals to another player on the team he didn't flinch.

Why? Because he's a kicker. They're a breed of their own and a group of players that are unique in many different ways. No matter what type of personality a kicker might bring to a field, a good one is always welcome.

"Evan is a very good kicker," Alexander said. "He helped us by being a steady contributor for us. If we scored we knew the extra point was going to be added on."

In fact, Corbeil missed just one all season. He went 36-of-37 for point-after attempts and hit 4-of-6 field goals with a long of 32 yards. Corbeil was also an All-Western Division selection this season.

"We're happy to have him back," said Alexander. "Having a kicker like that only helps a team. We expect him to have a great season next year."

Sam Eggleston can be reached at (248) 349-1700, ext. 104 or at seggleston@ht.comnet.net.

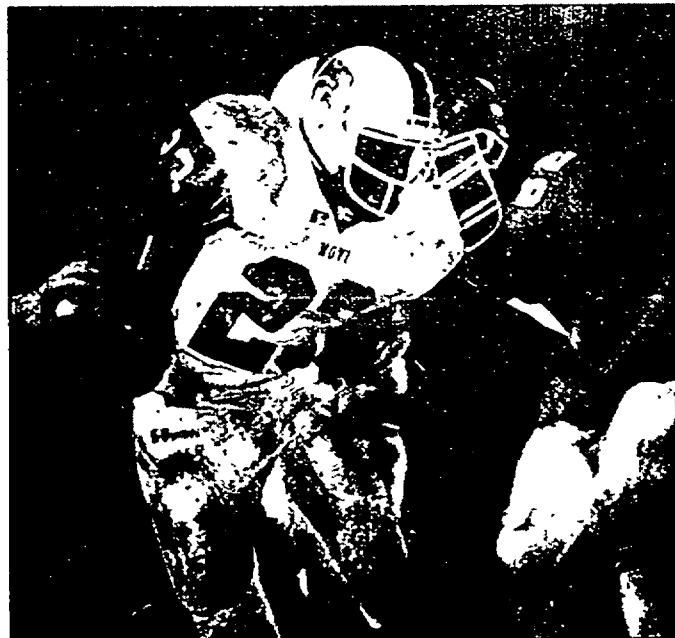

Photo by JOHN HEIDER/NORTHVILLE RECORD

Blasting his way through the Mustang line, Wildcat Jarrell Woods rumbles for a touchdown against Northville. Woods earned a place at running back for the All-Area team.

**"A ★★★★★ HOLIDAY COMEDY- TIM ALLEN HAS NEVER BEEN FUNNIER! AN INSTANT FAMILY CLASSIC!"**  
Gorman Woodfin, CBN (THE 700 CLUB)

TIM ALLEN JAMIE LEE CURTIS

**Christmas with the KRANKS**

REVOLUTION STUDIOS PG COLUMBIA PICTURES

**NOW PLAYING**

POCONO THEATRES 1313/338-3494	UNITED ARTISTS STATION 14 248-964-9611	IBC FARMINGTON 582-254-5623	STAR THEATRES CANTON 586-771-3429	STAR THEATRES PARK 18 734-462-4200	AMERICAN FAMILY CINCINNATI 248-953-2266	STAR THEATRES BIRMINGHAM 734-781-2200
BEACHES EAST CINCINNATI 313-982-7500	SHOWCASE CINEMAS HIGHLANDER 14 313-541-3449	STAR THEATRES EAST LANSING 248-454-4366	STAR THEATRES LANSING 734-462-4200	STAR THEATRES LANSING 734-462-4200	STAR THEATRES WEST RIVER CENTER 248-788-4372	STAR THEATRES WEST RIVER CENTER 248-788-4372
EMANCIPATION CANTON 734-771-3456	STAR THEATRES STATION 12 313-740-6389	STAR THEATRES TROY 248-454-4366	STAR THEATRES TROY 248-454-4366	STAR THEATRES TROY 248-454-4366	STAR THEATRES TROY 248-454-4366	STAR THEATRES TROY 248-454-4366

Sorry, No Patrons Accepted For This Engagement. Check Theater Directories For Showtimes.

**Visit Showtimes.SonyPictures.com**

# Three local golfers earn area honors

By Sam Eggleston  
RECORD SPORTS WRITER

It takes a cool player and a steady swing to succeed in the world of golf in HomeTown Newspapers' coverage area.

There are some of the toughest courses in the Metro area and the All-Area team has some of the toughest players who have conquered them.

## Earning accolades

Northville senior Jimmy Gates is never quite satisfied.

He plays hard, turns in some impressive scores but never quite sits back and tells himself it was good enough. Despite what Gates thinks of his own performances, others were impressed.

"Jim has a great all around game," said Tom Shaw, Northville's golf coach. "He can drive the ball incredible distances with great accuracy as well. His ability to focus and turn on his A-game when he needs to is a real asset."

Gates came through for his squad on more than one occasion. He was medalist four times for the Mustangs and was named Most Valuable Player of his team.

"He has shown why his fellow teammates elected him one of our captains by both leading on and off the golf course," said Shaw. "He set a positive example for both varsity and junior varsity players."

Gates earned a 77.5 average over 18 holes. He was an All-Western Division player this season and a second-time selection to the HomeTown Newspapers All-Area team.

Where Gates takes his golf seems to be up to him, said Shaw.

"His level of play would easily be an asset to a college program if he elects to continue to play after high school," he said.



Photo by JOHN HEIDER/NORTHVILLE RECORD

Novi's Mike Martinez tees off on the fifth hole at the Links of Novi.

## Repeat offender

Brett Jaussi is no stranger to the HomeTown Newspapers All-Area team. Last season, as a junior, he made the cut with the likes of Brandon Cigna and Eric Ayles — both Novi grads.

Jaussi is still in good company and this year he stands out just as much as he did one year

ago. With a 75 over 18 holes at the always-competitive Oakland County meet, Jaussi made it clear he intended to end his senior season playing well. He added an exclamation point with a 74 at the post-Kensington Valley Conference meet.

"Brett played some outstanding golf for us this year," said Novi coach Brad Huss. "We

knew we could always expect solid numbers from him on a consistent basis."

Jaussi has been recognized for his play as well. He earned first-team All-KVC recognition this season.

"Brett is a good player that knows the game," said Huss. "He's going to be hard to replace next year."

Novi is going to miss Jaussi, who has been a staple on the squad for the past few seasons. His will be one big swing to try and fill.

## Ending on a strong note

A senior knows their season is only as good as the way they end it. Novi senior Mark

Eberline ended it in style, nearly making the state meet as an individual and missing by just one stroke.

"Mark Eberline played extremely well in his last three tournaments," said Huss. "He tied (Player of the Year) Luigi (Spadafora) for medalist at the Oakland County meet."

Eberline is well aware of

what it takes to win in the Kensington Valley Conference. He climbed to the top of Novi's team with his scores this year and challenged in nearly every meet he was at.

Sam Eggleston can be reached at (248) 349-1700, ext. 104 or at [seggleston@ht.homecomm.net](mailto:seggleston@ht.homecomm.net).

# Area girls earn honors on first-ever team

By Sam Eggleston  
RECORD SPORTS WRITER

The HomeTown Newspapers All-Area swimming and diving team has been a long time in the making.

It has often been wondered why there hasn't been any in the past. The truth be told, Milford and Lakeland, two of the schools used to select All-Area teams, didn't have any swim teams.

Well, now they do and Northville and Novi were quick to earn places on the first-ever squad.

## Simply fantastic

Alex Tereszczenko is, quite simply, a fantastic swimmer. She's quick, she's strong and she excels in the events that she concentrates on.

Tereszczenko qualified for the state finals in the 200 freestyle event as well as the 500 free. As a member of a relay squad she earned a nod at the 400 free relay.

"It was a lot of fun," Tereszczenko said of her state finals swim. "I was excited with how well I did."

Though Tereszczenko said she wished she would have done

better, the senior tanker took 14th in the 500 free and a 10th in the 200 free. The relay team didn't make it out of the prelims.

Her best times this season are: 50 free: 24.87 seconds; 100 free: 53.55 seconds; 200 free: 1:55.28; 500 free: 5:11.39; 100 breaststroke: 1:19.06; 100 butterfly: 1:02.39; and the 200 individual medley: 2:19.68.

## Splendid senior season

Laura Lynch, a Novi senior, wanted her season to be the best of her career. It was.

Lynch was a team captain and one of the team leaders for the Wildcats this season.

"Laura's strengths are hard work and determination," said Novi coach Larry Teahan.

Lynch's best event was the 500 free where she took second in the KVC and at the River Rat Challenge. Her best time was 5:30.34 — just short of the state finals cut. She also swam the 200 free and in the 400 and 200 free relays for Novi this season.

## In the driver's seat

Northville senior Sarah Carr isn't the kind of swimmer that misses the state meet.

She's a strong swimmer, as shown by her times this year, and she never quits. As a member of the 400 free relay team she earned her trip to Ann Arbor and the state meet this season, though her squad didn't make it past the first day of competition.

Carr was known for swimming a variety of events throughout the season and being competitive in all of them. Her best times were: 50 free: 26.11 seconds; 100 free: 55.01 seconds; 200 free: 1:59.38; 500 free: 5:18.24; 50 breaststroke: 32.20 seconds; 100 breaststroke: 1:12.21; and the 200 individual medley: 2:20.75.

## Daring divers

Divers are an interesting group that aren't often associated with the "swimmers" of the team.

It is the only event where a member of the swimming and diving team earns their points from the opinion of another party. Amy Glubzinski does an amazing job of earning those points.

"She's Novi's best diver," Teahan said of the sophomore. "She came in first place in most of her dual meets."

Glubzinski won the West Bloomfield Invitational, was fifth in Oakland County and was third at the KVC meet.

"We had a large number of divers (11) on this year's team and Amy led them by example," said Teahan. "She was a positive role model and is very dedicated to her sport."

Glubzinski, who dives year round, had a best score of 189.70 for six dives and 312.45 for 11 dives.

## Solid senior

The Northville Mustangs were blessed with a very deep team this season. With so much talent on the squad, it was hard for a single swimmer to truly stand out. Kathryn Kusuplos managed to do just that.

The senior tanker put up some impressive numbers throughout the year.

Though she didn't specialize in just one event, Kusuplos managed to have good times

across the board.

Her best times were: 50 free: 27.38 seconds; 100 free: 56.98 seconds; 200 free: 2:09.08 seconds; 500 free: 5:49.60; 50 backstroke: 29.91 seconds; and 100 backstroke: 1:04.09.

## A family tradition

In Northville there are a few families that are known to excel in certain sports. In soccer it's the Kellehers, in cheerleading it's the Amblers and in swimming it's the Schwirings.

Alyssa Schwiring upheld the reputation her family has this season with some very impressive swims. She earned the top spot on more than one occasion and helped the Mustangs challenge for the top spot in the conference.

This season she swam some impressive times and continued to improve throughout the year. Her best times were: 50 free: 27.59 seconds; 100 free: 1:01.80; 50 backstroke: 30.15 seconds; 100 backstroke: 1:06.53; 50 butterfly: 1:06.26 seconds; and in the 100 butterfly: 1:05.26 seconds.

## It's in her blood

Junior tanker Sarah Bardsley of Northville is a darn fine swimmer. She's quick, she's smooth and she has plenty of stamina.

Her family hails from across the pond from a little island called England. Water laps at all sides of the nation there and so it seems the water must have been calling to her before she moved to the states.

Bardsley followed the call right to the pool where she has grown as a swimmer with some impressive times and finishes. This season she had some of her best-ever times: 50 free: 27.16 seconds; 100 free: 59.31 seconds; 200 free: 2:08.38; 500 free: 5:47.61; 50 backstroke: 33.54 seconds; 100 backstroke: 1:03.31; 50 breaststroke: 35.87 seconds; 100 breaststroke: 1:17.28; 100 butterfly: 1:06.24; and in the 200 individual medley: 2:23.34.

Sam Eggleston can be reached at (248) 349-1700, ext. 104 or at [seggleston@ht.homecomm.net](mailto:seggleston@ht.homecomm.net).

## OTHER ALL-AREA SELECTIONS

- |  |  |
|--|--|
| <p><b>BASKETBALL</b><br/>Marissa Bober, senior, Milford<br/>Kelsey Hackney, senior, Milford<br/>Kefanee Morrison, senior, S. Lyon<br/>Fallon Sanborn, senior, Lakeland<br/>Nicole Wilson, senior, Lakeland<br/>Katie Wissner, senior, Lakeland</p>   | <p>Bryan Lynch, junior, Lakeland<br/>Brett Quitiquit, junior, Milford</p>  |
| <p><b>BOYS CROSS COUNTRY</b><br/>Dana Pitcock, senior, Milford*<br/>Mike Andersen, senior, Milford<br/>Nick Andersen, freshman, Milford<br/>Luke Heiman, soph., Lakeland<br/>Andrew Keller, junior, S. Lyon<br/>Chris Mauney, junior, S. Lyon<br/>Matt Picou, junior, Milford<br/>Jason Sosnowski, senior, Lakeland<br/>Joel VanDerworp, senior, Milford</p> | <p><b>SOCCER</b><br/>Zac Bennett, senior, Lakeland<br/>Lloyd Brennan, senior, S. Lyon<br/>Kenny Coppola, senior, S. Lyon<br/>Ormeed Firoozgan, junior, Lakeland<br/>Gabe Hernandez, senior, S. Lyon<br/>Brandon Janssen, senior, Lakeland<br/>Sean O'Sullivan, junior, Lakeland<br/>Mike Rhoed, senior, S. Lyon<br/>Ryan Teeple, senior, S. Lyon</p>       |
| <p><b>GIRLS CROSS COUNTRY</b><br/>Charlie Green, soph., Milford*<br/>Michaela Crew, freshman, Lakeland<br/>Mallory Farnum, senior, Milford<br/>Allison Iott, senior, Milford<br/>Megan Jambeck, senior, Milford<br/>Megan Kaid, junior, Milford<br/>Sarah Martens, soph., Milford<br/>Megan Ray, freshman, Lakeland</p>                                      | <p><b>SWIMMING</b><br/>Liz Johnson, freshman, Milford*<br/>Olivia Briolat, freshman, S. Lyon<br/>Jessie Campbell, soph., Lakeland<br/>Melissa Faletti, junior, S. Lyon<br/>Chelsie Melkvik, senior, S. Lyon<br/>Shannon Mocer, freshman, S. Lyon<br/>Jessica Ross, junior, S. Lyon<br/>Jacqui Trabue, soph., S. Lyon<br/>Kelsey Trabue, soph., S. Lyon</p> |
| <p><b>GOLF</b><br/>Luigi Spadafora, senior, Milford*<br/>Jon Ambal, senior, Milford<br/>Ryan Blanzly, soph., Lakeland</p>  | <p><b>TENNIS</b><br/>Jessica Long and Emily Tucker, seniors, Lakeland<br/>Brenda Hewlett and Lauren Schicht, juniors, S. Lyon</p>  |

\* Indicates HomeTown Player of the Year honors



Photo by JOHN HEIDER/NORTHVILLE RECORD

Novi's Laura Lynch swims the 200 meter freestyle. She was selected to the first-ever All-Area swim and dive team.

**"THE BEST FILM OF THE YEAR."**  
- MIKE SZYMANSKI / TRIBUNE MEDIA

**"A GIGANTIC EPIC STORY."**  
- DAVID BREDER / HOLLYWOOD CLOSE-UPS

**"ALEXANDER" IS FILLED WITH SPECTACULAR BATTLES, OPULENT SETS AND GRAND PASSIONS. IT'S THE WORK OF A FIRST-RATE FILMMAKER."**  
- DAVID JENSEN / NEWSWEEK

**FARRELL**  
**ALEXANDER**  
FORTUNE FAVORS THE BOLD

INTERMEDIA INF R

For More Information About This Movie  
America Online Keyword: Alexander www.alexanderthemovie.com



## America's veterans: Following business tradition

Americans look forward to the day when men and women serving in combat far from home return safe and secure to their families, friends and communities around the nation.

For as long as this nation has existed, it has been defended by citizen-soldiers, the first of whom appeared on a small gathering spot in Lexington, Mass., nearly 230 years ago. "Minutemen," they dubbed themselves, for they vowed to be "ready in a minute" to take up arms against an oppressing enemy. As soon as the threats were repelled, America's first entrepreneurs put down their muskets, picked up their tools and went back to work as farmers, craftsmen and shopkeepers.

### Jack Faris

Like their risk-taking forebears, today's veterans have a strong entrepreneurial spirit. According to a study recently released by the U.S. Small Business Administration's Office of Advocacy, who has been charged with developing programs to assist veterans, nearly one-quarter of the veterans polled said they were either purchasing or starting a new business, or giving it some serious consideration. True to their Minutemen roots, nearly two-thirds of those classified as "new-veteran entrepreneurs" planned to initially open their businesses entirely from their homes and 67 percent foresaw expanding beyond their residences in the near future. Almost two-fifths of current-veteran business owners surveyed indicated their operations were entirely home-based small businesses. Of these, nearly 36 percent had plans to grow their enterprises outside of their homes.

Of course, today's armed forces are the most organizationally and technologically sophisticated our nation's history-applying their skills to meet the needs and challenges of modern combat. Those men and women who have returned and are starting new businesses are making good use of the training they received during their military service. For example, the SBA study found that 11 percent of the new-veteran entrepreneurs plan to be entirely Internet-dependent, while nearly one-third said their business would be 50 percent or more tied to the Internet. Almost a quarter of current-veteran business owners reported that their enterprises were 50 percent or more Internet-dependent.

Overall, the study determined that military service appeared to have provided a significant proportion of both new-veteran entrepreneurs and current-veteran business owners with skills necessary to operate a business. More than one-third of those queried in the study (both new-veteran entrepreneurs and current-veteran business owners) confirmed that they had gained skills while in military service that were directly relevant to business ownership.

It is comforting and re-assuring that after more than two centuries of answering the call to defend their nation, America's veterans retain the citizen-soldier tradition. That's the good news; the better news will come when those men and women bravely serving the nation throughout the world return-many of them to pursue the American Dream of small-business ownership.

To learn more about services available to veterans interested in beginning a business, visit [www.sba.gov/vets](http://www.sba.gov/vets).

Jack Faris is president of the National Federation of Independent Business, the nation's largest small-business advocacy group. A non-profit, non-partisan organization, NFIB represents the consensus views of its 600,000 members in Washington, D.C., and all 50 state capitals.

### Story idea?

Our readers have great ideas and we want to hear them. Send us your ideas.

Send it to:

Northville Record  
104 W. Main St.  
Northville, MI 48167  
Fax: 248-349-9832  
[dagular@nt.homecomm.net](mailto:dagular@nt.homecomm.net)

Advertorial



## Santa: 'At Milford Jewelers, I feel special'

### Great Elf dazzled by world's 'friendliest, most affordable' jeweler

Every year he arrives the same way, unexpectedly, thistles jingling, reindeer stomping. "Ho! Ho! Ho!" he rumbles as he floats from rooftop to cobble sidewalk, along Main Street in picturesque downtown Milford. "Ho! Ho! Ho!... Ho! Ho! Ho!... HO! HO! HO!"

Santa Claus arrives at Milford Jewelers each year, heart filled with love, gift bag slung across his burly shoulder, eager to renew old friendships. His first stop when entering the 441 N. Main St. store never changes: the cookie dish.

"Mrs. Claus said I can eat whatever I want between now and Christmas," he said. "All she wants in return is a something nice from Milford Jewelers — that's easy!"

Indeed, the world's most famous professional shopper knows just where to go when time is short and quality craftsmanship is essential. He knows when it comes to relaxed, friendly customer service and 30 years of professional expertise, sister and brother tandem Tamar Aguilar and Jacques Chopjian represent a family steeped in professional pride and unsurpassed for its attention to detail.

Santa also keenly understands the value of having your own workshop. "I couldn't imagine asking a third party to make our toys," he said. "That's why I shop here."

At Milford Jewelers, the story is the same. The family-owned business features three retail jewelry stores and its own jewelry manufacturing facility.

While most jewelers boast on-site repairs and custom-carved waxes — minimum industry standards — as featured practices, Milford Jewelers also humbly casts its own platinum, gold and silver and uses high-tech laser equipment for intricate repairs. The net result: ultimate customer design flexibility — and significant cost savings.

The family is well-known from the North Pole to Northville for its meticulous, hand-crafted dedication.

"Because we control the entire process, customers end up with exactly what they want — for less," Tamar said.

Even Santa. Tamar refused to divulge Mrs. Claus' gift. "That's a secret," she said, defiant. "He likes to buy her unique gifts. He's really good at finding just the right thing."

— Photos by Milford Jewelers —



Photo by Hal Gould

Jacques Chopjian and Tamar Aguilar comprise the brother-sister tandem who own Milford Jewelers, located at 441 N. Main St. in downtown Milford. The siblings are also proud members of a 30-year-old family-owned jewelry operation featuring four brothers, one (baby) sister, three retail jewelry stores and a jewelry manufacturing facility which provides customers unprecedented custom design flexibility — and significant cost savings.

### MILFORD JEWELERS

441 N. Main St. • Milford, MI 48381  
(248) 676-0721 • [www.milfordjewelers.com](http://www.milfordjewelers.com)  
Mon.-Fri. 10-6; Saturday 10-5; Sunday 12-4



For quality craftsmanship and affordable prices, Santa Claus knows what to do: see Tamar Aguilar at Milford Jewelers, located at 441 N. Main St. in downtown Milford.



ADVERTORIAL

## Rugg Brothers make customers top priority in carpet, duct, upholstery cleaning business

By Duane Ramsey  
 SPECIAL WRITER

Rugg Brothers Carpet Care provides carpet, upholstery and duct cleaning services for commercial and residential customers, specializing in stain removal, pet odor and stains, water damage and restoration.

Rugg Brothers sets itself apart from the competition by using the most advanced equipment and supplies for cleaning carpeting, ducts and furniture, according to Michael and Patrick Ruggiero, brothers who have been cleaning carpets and ducts for the past eight years.

"We always make customers our top priority and want them to be satisfied with our work," Mike said. "We get a lot of referrals and repeat business from our customers."

Located in South Lyon, Rugg Brothers serves customers in Oakland, Livingston and western Wayne counties. As well as being licensed, insured and bonded, the company is certified in the latest technology for cleaning carpeting, ducts and furniture.

The business operates four vehicles with the most advanced equipment to serve its customers 24 hours a day and seven days a week. They are committed to educating their employees to keep up with the latest technological advances in cleaning and restoration, Mike said.

Unlike many carpet cleaning services that offer specials but end up costing more when the work is complete, Rugg Brothers charges a flat rate of 25 cents per square foot with a \$75 minimum charge for one or two rooms, according to Mike.

"We follow the manufacturer's guidelines for cleaning carpet and returning the pH content to 7.5 or the appropriate level," Mike said.

Rugg Brothers uses a hot water extraction method with truck-mounted equipment that removes the deepest and toughest dirt gently and safely. Mike said no other method can provide a better cleaning that will last longer.



Michael and Patrick Rugg are carpet and duct cleaning specialists. Ducts and ventilation systems should be cleaned every seven to 10 years, and Rugg Brothers has the experience, equipment and expertise to do the job right.

They use Styrofoam blocks or plastic tabs to keep wood or furniture from contact with the carpet. Corner guards are used on all walls and woodwork to protect them against any damage during the cleaning.

A specially formulated pre-spray is injected deep into the carpet with high-pressure equipment. Mixed with a fiber softener and brightener, a powerful suction extracts the dirt, allergens and cleaning solution.

Rugg Brothers also offers a Teflon coating that is raked into the carpet leaving a protective coating on the carpet fibers to make vacuuming easier, Mike said. The optional Teflon coating costs an additional 14 cents per square foot.

"In addition to cleaning their carpet, people should clean their ducts every seven to 10 years. It is just as important to maintain

clean ductwork in your home," Mike advised. "The ventilation system is the biggest culprit of poor indoor air quality. Dirty ducts help circulate odors and contaminants such as dust, dust mites, dander and pollen."

Rugg Brothers offers a free inspection of a customer's duct work to determine if cleaning is necessary. Although they do not perform service work on furnaces, they vacuum out the furnace and visually inspect it for any possible maintenance problems.

The company cleans and sanitizes the entire heating, ventilation and cooling system in businesses and homes using truck-mounted mechanical cleaning equipment. An air turbine-powered vacuum agitates and removes dust, mold and debris from all the ducts.

After all ducts, vents and registers are cleaned and degreased,

**DETAILS**  
 Rugg Brothers Carpet Care, Inc.  
 Carpet and Duct Cleaning Specialists  
 Michael & Patrick Ruggiero  
 Call: (248) 446-2008 or make appointment online at: www.ruggbrothers.com.

they use a combination sanitizer, disinfectant and deodorizer designed for hospital and industrial use to sanitize the entire system. The EPA-registered formula is found to be effective in killing microbial organisms.

Additional information about the company's services is available on its Web site — www.ruggbrothers.com — where customers can make an appointment for carpet or duct cleaning.

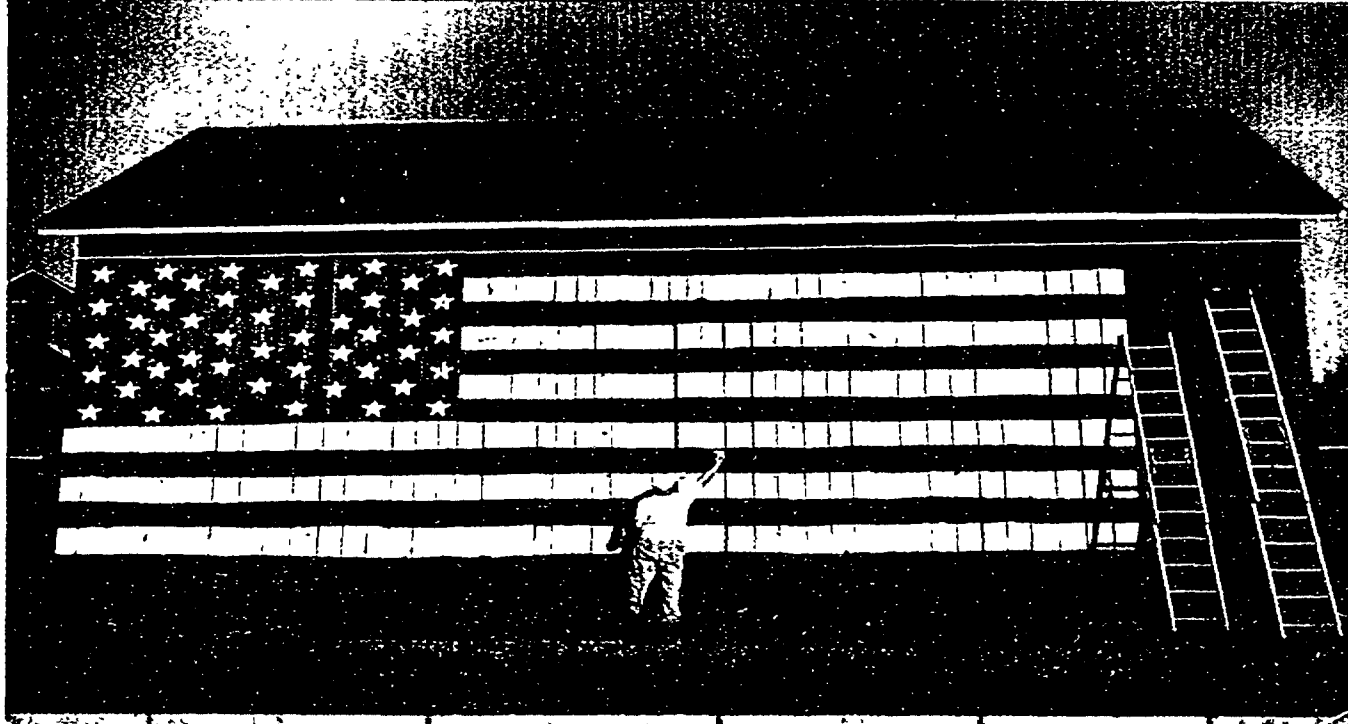

**"FOR TOO LONG OUR CULTURE HAS SAID, 'IF IT FEELS GOOD, DO IT.' NOW, WE WANT TO BE A NATION THAT SERVES GOALS LARGER THAN SELF. WE HAVE BEEN OFFERED A UNIQUE OPPORTUNITY. WE MUST NOT LET THIS MOMENT PASS. MY CALL IS FOR EVERY AMERICAN TO COMMIT TO THE SERVICE OF YOUR NEIGHBORS AND YOUR NATION. BY DOING THIS, WE SUSTAIN AND EXTEND THE BEST THAT HAS EMERGED IN AMERICA."**

★ ★ ★ **EVERYONE CAN DO SOMETHING.** ★ ★ ★

Answer the President's Call to Service. When you volunteer to help your neighbors, you help your nation. Everyone can do something. To learn more, visit [USAFREEDOMCORPS.GOV](http://USAFREEDOMCORPS.GOV) or call 1-877-USACORPS.



# Recently Sold Homes

**Farmington Hills City**  
 38887 Parkwood Ct \$347000  
 37846 Rhonswood \$395000  
 37846 Rhonswood \$395000

**Highland Twp.**  
 3388 High Knoll Dr \$30000  
 2343 Davista Dr \$100000  
 1690 Lombardy \$145000  
 4941 Eagle Road \$162000  
 4481 Hunters Dr \$205000  
 3971 Centennial \$275000  
 3531 Woodland Dr \$275000  
 3981 Woodland \$385000  
 4080 Loch Dr \$260000  
 393 Carnoustie \$487900  
 3131 Polo Way \$430000

**Lyon Twp.**  
 58545 Pontiac Trail \$175500  
 55844 Pontiac Trail Ct \$185000  
 30074 Cobblestone Lane \$222000  
 30073 Lamplighter Ct \$230000  
 28795 Hovey Lane \$315000  
 25970 Cobblers Lane \$70000  
 23854 Shinnecock Dr \$95000  
 53151 Shinnecock Dr \$95000  
 25848 Carriage Lane \$273000  
 54260 Belcrest Dr \$250000

**Milford**  
 2926 Augustine Road \$439900  
 165 Shelly Dr \$168000  
 468 Village Lane \$178108  
 701 Main St N \$181000  
 634 Hickory \$252000

**Novi City**  
 51011 Park Place Ct \$115000  
 20896 Glen Haven Circle W \$148000  
 43546 Serenity Dr \$405000  
 48107 Cedarwood \$195500  
 24355 Surfside Road \$224000  
 47961 Cedarwood \$239900  
 47122 Scarlet Dr S \$244000  
 22677 Cheshire Ct \$375000  
 22469 Fuller \$428000  
 24154 Elizabeth Lane \$453000  
 47652 Rochester \$455000  
 22785 Summer Lake \$460000  
 23989 Devonshire Dr \$470000  
 22785 Summer Lake \$472500  
 44100 Marlson \$78500  
 24243 Bashian Dr \$120000  
 24258 Myrtle Ct \$133000  
 23619 Stonehenge Blvd \$138000  
 24554 Olde Orchard St \$144000  
 39483 Country Lane \$175000  
 24140 Cranbrook Dr \$217250  
 23536 Cranbrook Dr \$221000  
 40281 Ladene Lane \$260000  
 22549 Chestnut Tree \$279000  
 43333 Windmill \$340000  
 24383 Cavendish Ave W \$457000  
 1155 Lake Dr S \$95000  
 179 Penhill St \$149900  
 41476 Belden Circle \$193000  
 41502 Oconnor Lane \$244400  
 915 Lemay \$262000  
 42684 Faulkner \$316800  
 42600 Faulkner \$328465  
 43006 Sandstone \$364000  
 30424 Norwich \$425000  
 1739 Lake Dr E \$426000  
 30295 Sterling Dr \$466000

**South Lyon City**  
 625 Crest Lane W \$76000  
 1146 Gentry Dr \$90000  
 144 Wellington St \$155000  
 336 Winchester St \$188000  
 939 Parkwood \$264000  
 1173 Shetland Dr \$323000

**Waterford Twp.**  
 5655 Oster Dr \$112000

If you are interested in sponsoring these home sales, please contact your HomeTown Account Executive:

Milford  
 (248) 685-1507

South Lyon  
 (248) 437-2011

Novi/Northville  
 (248) 349-1700



**ART.  
 ASK FOR  
 MORE.**

For more information about the importance of arts education, please contact [www.AmericansForTheArts.org](http://www.AmericansForTheArts.org).



All ads placed FREE on the internet! (up to \$87.00 value)

# CREATIVE LIVING

HOMETOWN www.hometownlife.com

3000-4980 REAL ESTATE

Homes 3000

**POLICY STATEMENT**  
All advertising published in Hometown Newspapers is subject to the conditions stated in the applicable rate card, copies of which are available from the advertising department. Hometown Newspapers reserves the right not to accept an advertiser's order. Hometown Newspapers sales reps have no authority to bind this newspaper and only publication of an advertisement shall constitute the advertiser's order. When more than one insertion of the same advertisement is ordered, no credit will be given unless notice of typographical or other errors is given in time for correction before the second insertion. Not responsible for omissions. Publisher's Notice: All real estate advertising in this newspaper is subject to the Federal Fair Housing Act of 1968 which makes it illegal to advertise any preference, limitation, or discrimination. This newspaper will not knowingly accept any advertising for real estate which is in violation of the law. Our readers are hereby informed that all dwellings advertised in this newspaper are available in an equal housing opportunity basis (FR Doc. 724983 Filed 3-31-72; 8-45am). Classified ads may be placed according to the deadlines. Advertisers are responsible for reading their ads the first time it appears and reporting any errors immediately. Hometown Newspapers will not issue credit for errors in ads after first incorrect insertion.

**OPEN SUNDAY, DEC. 5, 1-4:00**  
4902 Cemetery Rd., Fowlerville.  
REDUCED!!! Close to town and easy on paved road outside of Fowlerville. Immaculate 3 BR, 1.5 bath Ranch on 1/2 acre 1448 sq ft. with finished basement. Beautifully decorated with neutral decor... MOVE RIGHT IN! Natural fireplace in family room... Come see this deal at \$209,000.  
**SHIRLEY BESSERT**  
810-844-2265

**SEARCHING FOR A JOB?**  
Find one online at [www.hometownlife.com](http://www.hometownlife.com)

**REPOSSESSED log home packages!** Distress Liquidation! Cancelled builder order Factory direct, below wholesale. EZ T&G 2 3/4/5 bedrooms Sacrifice Prices 1-800-471-1811 Must sell! Spring Delivery!

**AVOID REAL ESTATE COMMISSIONS**  
www.877GoFlatRate.com  
J Edwards-Broker

Homes 3000

**READERS:**  
SINCE many ads are from outside the local area, please know what you are buying before sending money

**Open Houses 3030**

**OPEN SUNDAY, DEC. 5, 1-4:00**  
4902 Cemetery Rd., Fowlerville.  
REDUCED!!! Close to town and easy on paved road outside of Fowlerville. Immaculate 3 BR, 1.5 bath Ranch on 1/2 acre 1448 sq ft. with finished basement. Beautifully decorated with neutral decor... MOVE RIGHT IN! Natural fireplace in family room... Come see this deal at \$209,000.  
**SHIRLEY BESSERT**  
810-844-2265

**SEARCHING FOR A JOB?**  
Find one online at [www.hometownlife.com](http://www.hometownlife.com)

**REPOSSESSED log home packages!** Distress Liquidation! Cancelled builder order Factory direct, below wholesale. EZ T&G 2 3/4/5 bedrooms Sacrifice Prices 1-800-471-1811 Must sell! Spring Delivery!

**AVOID REAL ESTATE COMMISSIONS**  
www.877GoFlatRate.com  
J Edwards-Broker

Open Houses 3030

**Huron Valley Schools**  
Open Sunday, Dec. 5, 1-4pm  
OPEN, OPEN, OPEN! Getaway to this attractive home with fabulous wooded 8 1/3 acre setting on peaceful Round Pond with good fishing and great views. Home features pleasant work saving kitchen that opens to Great room with brick fireplace and doorway to spacious wrap around deck. 3 bedrooms, 3 baths, 16x14 sun room, large rec room in walkout lower level and 30x24 garage. \$393,000. Take Hickory Ridge Road North of M-59 past Clyde to West on Shagbark following open signs to 3660 Shagbark Lane England Real Estate (810) 632-7427.

**Open Houses 3030**

**LYNDEN SCHOOLS**  
Open Sunday, Dec. 5, 1-4pm  
OPEN DOORS! Spacious and tastefully decorated 2 bedroom condo with cul-de-sac setting! Beautiful white kitchen with snack bar opening to comfortable Great room with doorway to deck. Family room with gas fireplace, 1/2 bath and private office in custom finished walkout lower level. 1st floor laundry and 2 car attached garage too! \$214,000. Take US-23 to Owen Road go West to Linden Road then North to Oakwood Condos following open signs to 207 Inglewood Court England Real Estate (810) 632-7427.

**PLYMOUTH, CASTLE** like estate on 5 3/4 acres w/horse stables & pond. Prime property \$800,000 Open Sun. 1-4 8291 Brookville Ct-21 248-921-7560

**Open Sunday December 8 • 1-4pm**

**597 Dorchester Way • Milford**  
Priced much less than appraisal for quick sale! Located in a very nice subdivision between I-96 & Downtown Milford, in Huron Valley Schools! Very well maintained 4 bedroom, 2 1/2 bath with fireplace, hot tub and partially finished basement. Definitely one of the most beautiful professionally landscaped settings, wooded lots! MLS# 24140277 \$262,900.

**JULIE CREMONTE**  
734-216-1956

Brighton 3060

**Brighton/Howell** For sale by owner. Lake Chemung access. 1382 Elmhurst, off Hughes \$132,000 (810) 227-4584

**Howell 3160**

**2 BR., Laundry, hardwood floors & trim, great location on Grand River. Possible land contract a/c! \$119,900 (517) 223-8874**

**COZY HOME** on 1 acre, 2 br. 2 + car garage, lake privileges, appliances included, very nice! \$159,900 248-921-8580

**HARTLAND SCHOOLS** 3 br., 1 1/2 bath ranch. 2 acres, 2 1/2 car attached garage, pavement, \$214,900 Call Mike at Ext Sharp Group (810)599-0841.

**Howell 3230**

**2 ACRES.** Beautiful, 3 br., 2 bath ranch, w/hardwood floors, master bath, & deck. \$189,900 CROSSROADS REAL ESTATE, (810)227-3455

**HOWELL 1,456 sq ft.** Cape Cod with 3 bedrooms, 2 baths, 2 car attached garage, sprinkler system, landscaped, fenced in yard. Howell schools and many more wonderful features. Call Stacy Nixon, Heritage GMAC (517)376-2333

**UPDATED CHARMING** bungalow, 3 br 2 bath, fenced yard \$199,500 321 Jewett, downtown Howell

Highland 3210

**MOVE UP to luxury** Have the holidays at your estate. 4 br., 3 bath contemporary w/finished walkout. Fireplace, wet bar, & everything else on 1/2 acre Under \$300K. 247 information 800-679-3821 ext. 1011. www.kevinpetto.com Keller Williams

**VERY CLEAN,** 3 br. ranch. Great opportunity. Huron Valley Schools By owner \$110,000 248-887-1160

**Howell 3230**

**2 ACRES.** Beautiful, 3 br., 2 bath ranch, w/hardwood floors, master bath, & deck. \$189,900 CROSSROADS REAL ESTATE, (810)227-3455

**HOWELL 1,456 sq ft.** Cape Cod with 3 bedrooms, 2 baths, 2 car attached garage, sprinkler system, landscaped, fenced in yard. Howell schools and many more wonderful features. Call Stacy Nixon, Heritage GMAC (517)376-2333

**UPDATED CHARMING** bungalow, 3 br 2 bath, fenced yard \$199,500 321 Jewett, downtown Howell

Howell 3230

**HOWELL, COLONIAL,** 3 br., 2 1/2 bath, fireplace fenced yard and lake p. Regs. \$204,989. CROSSROADS REAL ESTATE, (810)227-3455

**NEW CONSTRUCTION,** 3 br., 1,600sq ft ranch, 2 full bath, master br. w/walkout, 2 car attached, c/a on 1 acre. Possible LC. \$212,900. 810-923-0025 810-923-9205

**HOWELL, 4 br., 2 1/2 bath,** walk to downtown, historic, lg lot \$240,000 (517) 545-5083

**CLASSIFIEDS**  
1-888-999-1288  
www.hometownlife.com

**CLASSIFIEDS**  
1-888-999-1288  
www.hometownlife.com

**CLASSIFIEDS**  
1-888-999-1288  
www.hometownlife.com

Homes 3000

**HARMON Real Estate**

**100 W. Grand River, Fowlerville**  
517-223-9193  
www.harmonrealestate.net  
OFFICE HOURS  
M-F 8:30-5:30 Sat. 9:00-4:00  
Evenings & Sun. By Appt.

**MANY POSSIBILITIES.** Vintage schoolhouse with long history has been converted to residential home on 1 acre lot. 20x40 pole barn with 220 electric and lean-to's on each side and a new shed makes for great storage. Short distance from town and pavement - minutes from I-96. Fowlerville Schools. \$119,000

**STORAGE GALORE,** 3 bedroom Ranch on 2.5 acres with 2 car attached garage, 16x30 second detached heated garage, master bedroom has 2 large double closets, fully finished basement with huge 9x11 walk in cedar closet. Shows like new! Come see for yourself. Home warranty included. Fowlerville Schools. \$219,900

**NEW CONSTRUCTION!** Located on over 2.5 acres, features include 3 bedrooms, 2 1/2 baths, gas fireplace in the living room, 9 foot poured walls and a 2nd floor laundry. Unfinished 13x14 bonus room could be 4th bedroom. Ceramic tile in the bathrooms, and hardwood floors throughout the kitchen and dining area. Still time to pick your colors! Only 5 minutes from I-96. Fowlerville Schools. \$229,900

**NEW TO THE MARKET!** Spacious 3 bedroom home located on Grand River 2 miles from the I-96 interchange. Large living room and dining room, first floor laundry and 2 full baths. Usable Michigan basement - lots of natural woodwork. 20x50 storage building could be 5 car garage plus older 20x70 storage building. Very charming and priced below bank appraisal. Wilmeton Schools. \$248,000

**COMMERCIAL & VACANT LAND**  
PERRY SCHOOLS... 16.5 acres and possible school of choice for Wilmeton. 40x80 pole barn plus attached 30x40 garage. Priced at \$135,000.  
FOWLerville SCHOOLS... Wonderful build sites on private drive 600 ft. off paved road. Great wooded and open areas. Perc & survey complete. 2.5 acres @ \$54,900 and 2.5 acres @ \$37,900 with conventional perc.  
COMMERCIAL PROPERTY... Zoned for light commercial use this 8 acre site has had nearly 30 years of greenhouse business at this location. Area growth makes it ideal for expansion to retail/wholesale greenhouse and landscaping business and site has been approved for min storage. Property could be split and land contract is available. Available for \$1,200,000. Contact Harmon Real Estate for more details @223-9193.  
COMMERCIAL PROPERTY... 1.75 acres of commercial property with 66' easement off Grand River. Within overlay of commercial zoning district. \$119,000  
FOWLerville SCHOOLS... Beautiful setting on paved road 5.8 acres @ \$75,900. To be priced & surveyed.

**FOR ASSISTANCE AFTER HOURS** call Paul Harmon @ 517-468-1122  
CONTACT OUR EXPERIENCED AGENTS FOR A "FREE MARKET ANALYSIS"!!!

**Quick Cash**  
www.hometownlife.com • 1-888-999-1288

**Lower Your Site Rent up to \$150/mo**

We will move your Home to our Northfield Estates Community in the Ann Arbor/Brighton area for FREE & immediately lower your site rent. Our Full Base Rent is only \$310/mo.

Call Today for Details!  
248 852-0741

## #1 Coldwell Banker in Michigan

<p><b>COHOCTAH</b> \$129,000</p> <p>Waterfront! You'll never need to go up north again. You'll swear you're there. This secluded get-away is in beautiful move-in condition. Great family escape. (OESLY16LAK) 248-437-4500</p>	<p><b>COMMERCE</b> \$279,900</p> <p>Spacious 3 br, 2.5 bath, 2 car garage ranch on private road. Move in condition. Updates include: Granite counter and ceramic tile in kitchen, crown molding, spectacular finished bsmt w/noisy cedar walls, bar and more! (OESLY50MAT) 248-437-4500</p>	<p><b>COMMERCE</b> \$130,000</p> <p>Very Neutral 2 Story Condo. Kitchen Has Ceramic Tile Floor. Updated Bathroom. Peaceful Courtyard Setting. Private Patio Backs To Woods &amp; Has Its Own BBQ Grill. All Appls Stay Gas &amp; Water Included In Assoc Dues. (OEN79KGN) 248-347-3050</p>	<p><b>COMMERCE</b> \$1,475/LEASE</p> <p>Entre House Just Renovated! House Sits On The End Of A Quiet Dead-end Street Across From The Golf Course. Updates Incl Tear-off Roof, Freshly Painted Interior/Exterior, All New Kitchen Cabinets &amp; Counters. (OEN81GOL) 248-347-3050</p>	<p><b>GENOA</b> \$309,900</p> <p>Premium location on golf course, 3 bedroom, 3 1/2 bath in prestigious neighborhood. Marble foyer, arched stairway. Professionally finished basement. (OESLY68PIN) 248-437-4500</p>	<p><b>GREEN OAK</b> \$269,900</p> <p>Beautiful lakefront living on 2.35 acres! Almost totally remodeled in 1997. 2400 sq ft., 3 bedroom, 1 bath, with open floor plan. Great for entertaining. Large island kitchen and first floor master. (OESLY25AQU) 248-437-4500</p>	<p><b>GREEN OAK</b> \$269,000</p> <p>Lots of land &amp; trees on 2.5 acres. 4 bedroom, 2 bath traditional home. Lower level walkout has family room with full brick fireplace. 16 X 12 workshop. Lots of windows a great family home! (OESLY51LLO) 248-437-4500</p>
<p><b>GREEN OAK</b> \$132,000</p> <p>Adult 55+ co-op. Open flr plan. Newer carpet, fn. basement. Florida rm. Large livingroom, 1st flr master. Bdrm &amp; bath downstair. Private yr &amp; patio. 1 car garage w/direct access. Lake privileges w/beaches &amp; dock (OESLY15CAU) 248-437-4500</p>	<p><b>HARTLAND</b> \$364,900</p> <p>Enjoy The Tranquil Retreat Of Dunham Lake! This Completely Remodeled Home On Approx 1 Acre Surrounded By Mature Trees. Open And Airy Floor Plan, Large Entertaining Rooms Incl Fam Rm W/tp. (OEN23BRI) 248-347-3050</p>	<p><b>HARTLAND</b> \$338,000</p> <p>Spacious 4 br, 2.5 bath Colonial on .82 acres. Island kitchen w/butlers pantry. Hardwood flrs to first flr. Master bath w/jacuzzi tub &amp; separate shower. Princess suite w/direct access to 2nd bath. Daylight bsmt. (OESLY69CLO) 248-437-4500</p>	<p><b>LOCKE</b> \$133,000</p> <p>Riverfront- bring your canoe and fishing poles! 1850sq ft., 3 bedrooms, 2 baths on 1 acre parklike setting. 3 car garage. Metabolous home with fireplace. Priced to sell quickly. Hurry! (OESLY82ALL) 248-437-4500</p>	<p><b>MANCHESTER</b> \$193,000</p> <p>Village Living On 1.3 Acres. Just A Short Walk To Historic Downtown Manchester. A Private Wooded Setting Close To Fishing, Village, Wildlife Preserve You Can Lounge On Your 12x36 Deck &amp; Watch The Wildlife (OEN33ADR) 248-347-3050</p>	<p><b>NORTHFIELD</b> \$399,000</p> <p>Custom built 5 bd, 3.5 bath brick ranch on 5+ partially wooded acres on private dr. Klt features: Handcrafted hrdwd cab, built-in gas range, db ovens. Great rm has lg flr to ceiling fireplace-deck. Pro fn w/ bsmt! (OESLY85AIN) 248-437-4500</p>	<p><b>NORTHFIELD</b> \$239,000</p> <p>Wow! All sports lake privileges on Whitmore Lake on quiet dead end street! Brk pavr patio for entertaining. Large lot w/sprinklers. Spacious w/motivated sellers (OESLY30HOR) 248-437-4500</p>
<p><b>NORTHVILLE</b> \$769,900</p> <p>Rare Find - Glenn Abby Floorplan W/rimmed Occupancy! Ceramic Tile (18x18) In Foyer, hallway, kitchen, hearth Rm &amp; Laundry. premium Stone Elevator, spacious Kitchen W/adjoning Nook/heart Rm W/tp, Cherry Cabinets T/o. (OEN92COG) 248-347-3050</p>	<p><b>NORTHVILLE</b> \$759,900</p> <p>Abundance Of Upgrades! Gourmet Klt W/granite/oversized Island &amp; Stainless Appl/mable Flrs In Foyer/hall Bath &amp; Klt/walkout W/ 23x57 Theatre/game Rm, 5th Bdrm, gorgeous Bar W/concrete Counter (OEN406RN) 248-347-3050</p>	<p><b>NORTHVILLE</b> \$315,000</p> <p>The Perfect Family Gift! Fabulous 2-story On Oversized Lot W/mature Trees Backing To Commons Area. Open Kitchen W/newer Ceramic Tile, Oak Cabinets, Breakfast Nook, Formal Dining Rm W/ Bay Window &amp; Chair Molding. (OEN33OUR) 248-347-3050</p>	<p><b>NORTHVILLE</b> \$139,900</p> <p>Gorgeous, Updated &amp; Clean-what More Could You Ask For? Move Right In To This Well Maintained Unit W/updated Ceilings, Newer Neutral Carpet, Paint, Kitchen &amp; Laundry Flrs, Hwh, Updated Mstr Bath. A/c. (OEN27NOR) 248-347-3050</p>	<p><b>NORTHVILLE</b> \$135,900</p> <p>Sitting Among Trend Hills &amp; Bordered Windows, This Fabulous 2bdrm, 2 Bath Condo Is Very Clean &amp; Neutral Wonderful Updated Eat-in Kitchen &amp; Formal Dining Too! A Relaxing Patio For Sun Summer &amp; Fall Socials. (OEN75NOR) 248-347-3050</p>	<p><b>NOVI</b> \$630,000</p> <p>Make A Grand Entrance In This Spectacular 2-story Home Custom Built W/detail &amp; Quality Workmanship T/o Dramatic 2 Story Foyer, Formal Dining Rm, Custom Frl, Gourmet Kitchen W/42 Cabinets, Mstr Ste W/glamour Bath (OEN46SUN) 248-347-3050</p>	<p><b>NOVI</b> \$489,900</p> <p>Metabolously Maintained Colonial Boast Beautiful Views, Backing To The Commons! This Tastefully Decorated Home Has It All-cozy Fam.rm W/tp, Huge Kitchen Provides Rm For Than "I" Gourmet Chef, W/center Island (OEN23FUL) 248-347-3050</p>
<p><b>NOVI</b> \$380,000</p> <p>Lrg &amp; Spacious Rms W/open Flr Plan Enhance This Well Maintained Home. Gorgeous Newer Pella Windows T/o &amp; Newer Pella Doorwall (00). All New Inl 6 Panel Drs (03). Ext Painted (02). Newer Hrdwd Flring 2 Story Foyer (OEN77DAV) 248-347-3050</p>	<p><b>NOVI</b> \$375,000</p> <p>A Harvest Of Features! One Look &amp; It's Sold! Custom 2 Story W/ Formal Living/dining Rm, 2 Story Foyer W/oak Banister, Hwd Flrs Library W/built-in Bookshelves, Open Kitchen W/center Island, Eat-in Nook. (OEN54WHI) 248-347-3050</p>	<p><b>NOVI</b> \$319,900</p> <p>Ideally Located-walking Distance To Downtown &amp; Close To Schools. Lrg Home Site On 1/2+ Acre Lot Full Of Perennials. Great 4 Season Sunrm W/lots Of Windows, Skylts, &amp; Attached Workshop. (OEN09GAL) 248-347-3050</p>	<p><b>NOVI</b> \$260,000</p> <p>Change Your Life Style! Remarkable Custom Built Detached Condo W/beautifully Landscaped Secluded Yard Private Entry, Formal Dining Rm, Great Rm W/tp W/mable Surround, Hwd Flrs In Foyer, Kitchen, &amp; Great Rm. (OEN05AND) 248-347-3050</p>	<p><b>NOVI</b> \$144,900</p> <p>Wow! Super Privacy Facing Woods. Stand Alone Cottage Ranch All in Neutral Tones. Updates Incl some Windows, Furnace, A/c, Hwh &amp; Garage Door. Huge Living Rm Opens To Dining Rm-cathedral Ceiling Great Open Flr Plan. (OEN28GLE) 248-347-3050</p>	<p><b>SALEM</b> \$459,900</p> <p>Tranquil Country Setting For This Custom Built Cape Cod On 1.46 Wooded Acres. Gorgeous Wood Flrs &amp; Ceilings On 1st Flr, Island Klt W/loads Of Cabinets, 1st Flr Laund, &amp; Mstr Ste W/glamour Bath. (OEN79AB) 248-347-3050</p>	<p><b>WALLED LAKE</b> \$209,000</p> <p>New Construction! Never Lived In! Many Updates Throughout Unit, Open Floor Plan, All New Appliances Included. Poss.furnished, Lake Privileges To Walled Lake Across Street, Finished Lower Level, Premium End Unit (OEN25OLD) 248-347-3050</p>

It's on the market, it's on our website...www.cbcschweitzer.com  
 Northville Office 248-347-3050 • South Lyon Office 248-437-4500  
 Thinking of changing careers or offices? Why not join the Number One Coldwell Banker Affiliate in Michigan.







<p><b>Apartments/Unfurnished</b> (4006)</p> <p><b>BRIGHTON, DOWNTOWN</b> Clean &amp; quiet 2 br, storage, appliances, hot water, AC \$650/mo. (248)766-0858</p> <p><b>BRIGHTON</b> Quiet, smoke-free complex, on Mill Pond Spacious, 1 &amp; 2 br, executive quality, laundry facilities on site. No pets please \$800/mo, incl heat/water Security &amp; refs 810-229-9930</p> <p><b>BRIGHTON</b> 940 E Grand River Spacious, 1 &amp; 2 br, heat/carpport incl No pets \$565-\$665/mo 517-404-2866 248-521-1980</p> <p>Farmington Hills <b>Live FREE - Ask Us How!</b></p> <ul style="list-style-type: none"> <li>• 24-hr Fitness Center</li> <li>• Hot-tub</li> <li>• In-home washer/dryer</li> <li>• Covered parking</li> <li>• Pets live FREE</li> <li>• Short term &amp; furnished available</li> <li>• SATISFACTION GUARANTEED</li> </ul> <p><b>REDUCED RENTS*</b> 1 bedroom apts from \$750* 2 bedroom apts from \$850*</p> <p><b>DIAMOND FOREST</b> 877-262-7949 WWW.diamondforrest.com <small>*New residents only For a limited time</small></p>	<p><b>Apartments/Unfurnished</b> (4006)</p> <p><b>Novi</b> <b>Live FREE - Ask Us How!</b></p> <p><b>1 &amp; 2 bedroom apts. from \$695*</b> <b>1, 2 &amp; 3 bedroom townhomes from \$750/mo*</b></p> <ul style="list-style-type: none"> <li>• Large Floorplans</li> <li>• Full Basements</li> <li>• Playground</li> <li>• 24-Hr Fitness center</li> <li>• Non Schools</li> <li>• Covered Parking</li> <li>• Pets welcome</li> <li>• Earn Equity while you rent</li> </ul> <p><b>Novi Ridge</b> (877) 329-2286 www.noviridge.com <small>*For a limited time New residents only Call for details</small></p>	<p><b>Apartments/Unfurnished</b> (4006)</p> <p><b>SOUTH LYON</b> - Nice 1 br apt. Only \$509/mo! No security deposit (248) 563-7290</p> <p><b>SOUTH LYON</b> - \$565/mo. Avail. now 2 br Free heat &amp; water Laundry, parking Application &amp; security req No dogs www.huronapts.com (734) 482-1800</p>	<p><b>Condos/Townhouses</b> (4020)</p> <p><b>COMMERCIAL</b> Brand new 2 bdr, both master suites, 2.5 bath, 2 car attached, fireplace, private patio &amp; entrance, appliances \$1,200/mo. (248) 212-4555</p> <p><b>HIGHLAND CONDO</b> Great 2 br, ranch, appliances. AC, patio, very nice. \$725/mo. (248) 687-4254</p> <p><b>HOWELL</b> New Executives 2 br condo 2800 sq ft, 2 car garage, all new appliances No smoking, no pets. Avail. 1/15 \$1,495/mo. (517) 546-9019 www.L2P.com/condo</p> <p><b>MILFORD</b> 1 Br., Walk to downtown. \$610/mo incl. gas &amp; electric. No pets/smoking (248) 343-6194</p> <p><b>MILFORD VILLAGE</b> 1800 sq ft. 3 br., 2 1/2 baths, hardwood floors, 2 car garage. \$1,450/mo (248) 884-3500</p> <p><b>NORTHVILLE</b> -3 bed, 1.5 bath, free heat/water \$99 1st mo Rent to own No bank qualify Low down payment. \$1300/mo. (810) 423-4112</p> <p><b>NOVI/WALLED LAKE</b> 700 sq ft., 1 br., air, washer/dryer, balcony, carport. Lakefront. \$695/mo (810) 225-4430</p> <p><b>S. LYON</b> 1300sq ft., cathedral ceiling, 2 br., 2 bath, carport. No pets \$995 517-552-9145</p> <p><b>S. LYON</b> Fountain View condo Lease w/ opt. 2 br., 2.5 bath ranch w/ bsmt. 734-476-7797</p> <p><b>SOUTH LYON</b> 1 bedroom condo, \$750/mo Immediate occupancy. (248) 437-8189</p> <p><b>SOUTH LYON</b> 1 br., remodeled, c/a, appliances. \$695 Immediate occupancy. Call 248-437-8709, 248-388-4486</p> <p><b>SOUTH LYON</b> 2 br. condo, fully updated, \$625/mo. First month free. (888) 940-3333</p> <p><b>WALLED LAKE</b> 1 br., large deck, 1 car garage, lease privileges, 6 or 12 mo lease \$800, unfurnished, \$1,000 furnished, plus 1 mo security 734-331-4164 734-368-1617</p>	<p><b>Duplexes</b> (4030)</p> <p><b>HAMBURG</b> - Country duplex on 1 acre Minutes from x-ways. \$725/mo. No pets. 734-449-2239, 734-260-1244</p> <p><b>HOWELL</b> Lg 3 br. downtown. Immediate occupancy! Short term ok. Non smoking Small pets ok. \$885 517-548-4945</p> <p><b>HOWELL</b> - 2 br. 2 minutes from Kensington Outlet Mall. No pets. \$725/mo 734-449-2239 734-260-1244</p> <p><b>HOWELL</b> - 2 br., 1 bath, newly updated, lg yard \$725 + 1.5 sec deposit. (517) 546-0035</p> <p><b>HOWELL DUPLX</b> - 2 br, new interior &amp; new appliances, air cond., paved parking \$700 per mo. (517) 404-7504</p> <p><b>HAMBURG</b> - 6465 Buckshore 2 br, well insulated, laundry Beach public access \$800 (313) 231-1120</p> <p><b>PINCKNEY</b> - Townhouse style duplex, 2 br., 1.5 bath, full bsmt., a.c., appliances, pets ok. \$750/mo. 734-878-5252</p> <p><b>PINCKNEY AREA</b> 2 &amp; 3 br., lake access \$575/5760 + utilities. No dogs. 734-662-8669</p> <p><b>PINCKNEY, Holiday</b> Special! Patterson Lake new/access. 1,000sq ft., 1 br., new flooring/paint/bathroom, lg yard \$650 + security. 1/2 off 1st mo. thru Dec 31st (248) 889-1232</p> <p><b>SOUTH LYON</b> All appliances, dishwasher, microwave, air, washer &amp; dryer, and more. 1 MONTH FREE RENT Cats OK \$640 810-220-2360 www.TandRProperties.com</p> <p><b>SOUTH LYON 1 mo. Free rent</b> 2 br., 1 bath, c.a., shed, washer &amp; dryer. New carpet. \$675/month. (248) 685-0900</p> <p><b>SOUTH LYON</b> Attractive, 2 br Heat &amp; water included. No pets. Available Dec. 1. \$585 + security. 734-453-1735</p>	<p><b>Homes For Rent</b> (4050)</p> <p><b>FOWLERYVILLE</b> Lg. 3 br., living &amp; dining rm, laundry, 1.5 bath, newly remodeled. NO PETS \$900, 1st + sec. 248-684-5002</p> <p><b>HIGHLAND</b> - 3 br., 1 bath, 900sq ft., 3 miles N of M-59, off Milford Rd \$800/mo (248) 685-2264</p> <p><b>HIGHLAND TWP.</b> 2 br., 1 bath, a.c., 1200 sq ft., rural setting \$750/mo (248) 887-3693</p> <p><b>NORTHVILLE</b> - Downtown 3 br., 2 baths. Call 1-888-808-8795, ext. 8606</p> <p><b>MILFORD IN THE VILLAGE</b> Fireplace, 3 br., garage, fenced yard, no pets \$850/mo + security (248) 684-6855</p> <p><b>NOVI</b> 3 br., 2 bath, 2 garage, located 9 Mi. &amp; Meadowbrook. \$1450/mo. (248) 760-3373</p> <p><b>NOVI</b> - 4 br. Colonial, 2 car garage, all appliances, 2.5 bath, privacy fence \$1700/mo Call David, (248) 214-1015</p> <p><b>NOVI</b> Lease 4 bedroom Ravines at Island Lakes Russ/Kessler and Company 248 643-9099 #104</p> <p><b>NOVI</b> 3 br., stove, fridge, woodered area, fenced yard \$900 No pets. (248) 319-7444</p> <p><b>PINCKNEY</b> - 4 br., 2.5 bath, 2,000+sq ft. \$1,200/mo Ann Arbor Realty, (734) 663-7444</p> <p><b>REDFROD</b> Two bed brick with master suite in very nice Redford neighborhood Full basement, 2 car garage, central air, washer, dryer, stove, refrigerator, large fenced yard. \$800 + 1 1/2 mo. security (313) 255-2699 for appt.</p> <p><b>SOUTH LYON</b> 3 br., 3 bath, 1,700sq ft. \$1,200/mo + security deposit. Immediate occupancy (248) 921-2101</p>	<p><b>Homes For Rent</b> (4050)</p> <p><b>WALLED LAKE</b> 3BR Bungalow, Walled Lake Schools, New house, walk to Walled Lake Beach. \$995/month</p> <p><b>HIGHLAND</b> 2BR, Huron Valley Schools, Nicely remodeled in 2004. Large treed, fenced lot. \$795/month</p> <p><b>HOLLY</b> 2 Bedroom house. \$650/month (248) 887-7500</p> <p><b>HOWELL</b> 5 br. Cape Cod, 2,200 sq ft., 2 baths, utilities, decks, bk access, clean. \$1,600/mo \$750 sec. 248-788-3746</p> <p><b>HOWELL</b> 5 br. farmhouse, 1 acre, short or long term lease. \$1350/mo. Avail. Jan. 1st Call Carl Vagnetti, (810) 499-7370</p> <p><b>HOWELL</b> - 4 br., 2 bath, 1,750sq ft., attached 2.5 car, 3 wooded acres. \$1,100/mo (517) 546-4193</p> <p><b>HOWELL - LUXURY 4 BR.</b> On 7.9 wooded acres, jet tub, all new appliances, 3 baths, walkout bsmt., w/office &amp; kitchenette, 2 decks, 100% handicap accessible, \$1,850/mo. (734) 476-9250</p> <p><b>HOWELL</b> New Executives 2 br condo, 2800 sq ft, 2 car garage, all new appliances. No smoking, no pets. Avail. 1/15 \$1,495/mo. (517) 546-9019 www.L2P.com/condo</p> <p><b>HOWELL</b> 1 br. apt. in lovely Victorian downtown. \$575/mo includes heat. 313-393-0103</p> <p><b>LAKELAND</b> 5 br., 1700 sq ft., finished bsmt, 1 acre lot, nice neighborhood, appliances, air, gas heat, no garage \$1,300/mo. (810) 231-9687</p> <p><b>MILFORD</b> - 3 br., 2 story, beautiful, quiet serene setting w/stable land on 2 sides No smoking/pets \$925/mo (313) 678-5458</p> <p><b>MILFORD IN the village</b>, 3 br, 1 1/2 bath, c.a., 2 car garage \$1,100/mo 248 343-6623</p> <p><b>NORTHVILLE</b> - Downtown 1100 sq ft. Ranch, 2 br., 1 bath, all appliances, finished bsmt w/ full bath, possible 3rd br, 1 car garage, Min. 6 mo lease (248) 349-7212</p>	<p><b>Lakefront/Waterfront Homes/Rent</b> (4060)</p> <p><b>MILFORD</b> cottage, Sears Lk. Many upgrades, 2 bc., 2 bath. \$1000/mo (248) 905-9343</p> <p><b>PINCKNEY</b> 2 homes available on Whitewood Lake. 1 completely furnished Starting at \$1500/mo includes maintenance Call for details. (810) 231-2778</p> <p><b>Mobile Home Rentals</b> (4070)</p> <p><b>AVAIL. 1/15/05</b>, Light industrial 2660 total sq ft. w/ 567 sq ft. office. Milford (248) 684-5928</p> <p><b>BRIGHTON</b> 2 br, private property/country \$600, 1st &amp; last + utilities 810-923-7920</p> <p><b>Mobile Home Sites</b> (4080)</p> <p><b>HOWELL</b>, Best rentals 2 bdr. Free water \$655 moves you in! Great location on Grand River 517-546-1450</p> <p><b>Vacation Resort/Rentals</b> (4100)</p> <p><b>SANIBEL ISL. FLA.</b> - Gulf front condo 2 bdr/bath, sleeps 6 Just remodeled. Avail weekly Jan. - April. \$1100-\$1735/per wk. 810-227-9474.</p> <p><b>Living Quarters To Share</b> (4120)</p> <p><b>BRIGHTON</b> Female preferred. \$420/mo. utilities included Washer/dryer (810) 333-5845</p> <p><b>COMMERCIAL TWP.</b> Housemate wanted to share spacious home. 3rd level, in family oriented subdivision Private br &amp; bath Storage available \$600/mo. + 1/2 of utilities (248) 860-3723</p> <p><b>Rooms For Rent</b> (4140)</p> <p><b>S. LYON/NOVI</b>, Low wk/day rates. TV, fridge, Country Meadow Inn, Pontiac Trail, 248-477-4421. Fairlane Motel, Grand River, 248-347-9999</p> <p><b>WALLED LAKE</b> area. Clean, furnished, utilities included, cable, security deposit. \$100/week. (248) 360-9355</p> <p><b>Office/Retail Space For Rent/Lease</b> (4200)</p> <p><b>BETWEEN BRIGHTON &amp; ANN ARBOR</b> off US-23. Convenient, very nice, single offices or can combine. Shared common facilities: kitchen, washing room, internet. Call (734) 449-5040.</p> <p><b>BRIGHTON</b> - Grand River frontage, single private office, shared facilities 810-229-8238</p> <p><b>BRIGHTON</b> downtown location, 210 E. Main St. 2 rooms, private bath, utilities incl \$500/mo (810) 229-2971</p> <p><b>BRIGHTON</b>, 1,450sq. ft. bldg 6121 East Grand River Includes roof sign. \$1,200 per mo (586) 801-5647</p> <p><b>HOWELL</b> Office or Retail space in new bldg 760 sq ft. near downtown. No triple net. Call Ted, 517-546-0001</p> <p><b>HOWELL DOWNTOWN</b> - Over 600 sq ft., 3 room office. Call 517-546-1434, 517-546-3164</p>	<p><b>Office/Retail Space For Rent/Lease</b> (4220)</p> <p><b>LEASE OFFICE AND/OR WAREHOUSE SPACE</b> 1/2 mile from downtown Brighton Perfect for small business or professionals Window suites begin at \$250/mo No triple net Call Derek, (810) 225-7500</p> <p><b>Commercial/Industrial For Rent/Lease</b> (4230)</p> <p><b>AVAIL. 1/15/05</b>, Light industrial 2660 total sq ft. w/ 567 sq ft. office. Milford (248) 684-5928</p> <p><b>BRIGHTON</b> Heated warehouse 16 ft. ceiling - 1500 sq ft., 10 ft. overhead door, clean &amp; new part., \$850/mo 248-505-9122</p> <p><b>GREEN OAK TWP.</b> Industrial buildings for lease 1,600sq ft., w/6ft ceilings, office, overhead door, on I-96, \$1,100/mo</p> <p><b>21,000sq ft.</b>, beautiful offices, 18ft. ceilings, overhead door, on M-36 @ US-23</p> <p><b>24,000sq ft.</b>, plus 3,100sq ft. office, 23ft. ceilings, 208/3 phase, 4 docks, 2 overhead doors, very clean. Off M-36 @ US-23</p> <p><b>Zander Industrial Plaza</b> 810-231-3300</p> <p><b>HOWELL</b>, Near Downtown, 240-2,000sq ft., retail, office (\$6/ft) warehouse (\$3/ft) light industrial. 517-546-7030</p> <p><b>MILFORD/WIXOM AREA</b> 6,000sq ft. office/warehouse. Heavy industrial, outside storage. (248) 684-6381</p> <p><b>Garage/Mo Storage</b> (4300)</p> <p><b>BRIGHTON</b>, GARAGE for rent. \$80/month Call 810-229-5167.</p> <p><b>Lease/Option To Buy</b> (4380)</p> <p><b>BRIGHTON DOWNTOWN</b> 2400 sq ft. 4 bedroom completely renovated home Rent to own terms available Call John at 248-752-7120</p>	<p><b>Lease with Option. No Banks needed! 48 hour approval! Howell, 550 Roselane, 1200 sq. ft. 3 bd, 2 ba, \$1295/month. Straights rental available Highland, 3300 Giddings, 1150 sq. ft., 3 bd, 1.5 ba, \$1195/month. MajesticRentals.com Compass Property Solutions, LLC</b></p> <p><b>WIXOM</b> - 2,250 sq ft., 4 br, 2 full baths, detached garage, Walled Lake schools, \$1500/mo. + utilities Call (248) 320-8000, ask for Paul.</p> <p><b>Lakefront/Waterfront Homes Rental</b> (4060)</p> <p><b>BRIGHTON</b> Lkfront, nice 3 br. 2 full bath, close to 96 &amp; 23 Optional for sale by owner. \$1300/mo Matt 810-229-8122</p> <p><b>BRIGHTON</b> Woodland Lkfront 2 br, 1.5 bath, fireplace, no pets, garage, avail. immediately 1,000/mo 810-632-6384</p> <p><b>BRIGHTON</b> - Boating &amp; Golf. Richly appointed Ranch condo in golf course community Dock space on high demand all sports lake 2 br., 2 bath up master suite, custom kitchen, finished lower level has 3rd bath &amp; sauna, 2 car attached garage. Non smoker \$1,750/mo (810) 632-6386</p> <p><b>BRIGHTON</b> - 2,500 sq ft., 4 br, 2 full baths, detached garage, Walled Lake schools, \$1500/mo. + utilities Call (248) 320-8000, ask for Paul.</p>
---	--	---	---	--	--	---	---	--	---

**Years to buy it... Minutes to sell it.**

**14' FISHING BOAT**  
Lowest bid \$2000. 20' to 30' boats, perfect for fishing. Only \$800. Call 248-505-9122

**We can help you.**  
Let one of our classified specialists help you create an ad that will cost your boat off to a prospective buyer.

**Green Sheet Classifieds**  
1-888-999-1288  
www.hometownlife.com

**John Goodman**  
"The Proven Choice"  
Coldwell Banker Schweitzer  
www.john-goodman.com  
(248) 347-3050 x254  
(248) 908-2799 Pager  
\*Professional Athlete Specialist

**MEADOWS OF SOUTH LYON** Condo style apts 2 & 3 bedroom, newly renovated 1st month FREE rent. Starting at \$695 per mo 248-767-4207

**MILFORD** downtown, 1 br upstairs loft w/deck, appliances, private entrance, no smoking \$975/mo (248) 685-3301

**MILFORD** - 1 & 2 bedroom apts., starting at \$517 Fully carpeted, central air heat incl No pets (248) 684-0841

**MILFORD VILLAGE** 1 br, \$800/mo Utilities Included (248) 622-6856

**MILFORD VILLAGE**, 1 br., spacious upper level, new remodeled \$635/mo 248-685-7082

**MILFORD**, Sea Marine Apts. 1 & 2 br Centrally located from town Small pet friendly Available now 248-685-1524

**NEW HUDSON** 2 br., 1.5 bath, pets welcome 6 month/1 year lease \$750/mo., \$500 security Call (248) 640-7531

**NORTHVILLE** - Downtown 1 br 1 bath Call 1-888-808-8795, ext. 8607

Northville's most unique apartments Choose from a variety of floorplans including cool 1 bedroom lofts and expanded one bedrooms with den all in a streamsides setting \$675-\$825

**ONE MONTH FREE**  
The Tree Tops (248) 347-1690  
Novi Ridge north of 8 Mile

**NORTHVILLE**, downtown 1 br, appliances \$525 No pets (248) 349-7482

**BUILDER'S CUSTOM MASTERPIECE IN NORTHVILLE**  
This beautiful home features soaring two-story foyer, staircase from kitchen and foyer with decorative railing; Brazilian cherry floors in foyer, dining room, kitchen, study and half bath; granite counters throughout; three fireplaces; 9 ft. ceilings and 8 ft. doors on first floor; finished daylight basement with kitchen, two bedrooms, family room and bath; Trex deck with built-in hot tubs; 3.5 car garage. \$999,900

**LANDSCAPED TO PERFECTION IN LYON TOWNSHIP**  
Over \$120,000 in upgrades, cathedral ceiling and California stone natural fireplace in great room, extra deep finished walkout (03), full bath w/lux tub, new large deck, hardwood floors in foyer, dining room & kitchen, 9 ft. ceilings, first floor laundry, loft w/lights. \$479,900

**PRIVATE CUL-DESAC LOCATION IN MILFORD**  
Located deep in the sub this home features natural fireplace in great room, hardwood floors in foyer, kitchen & half bath, 2nd floor laundry, skylight in main bath, new central air, finished basement, private yard w/goldfish pond, 2.5 car garage, sidewalks. \$179,900

**PRIVATE COLONIAL IN EMDERRY HILLS IN NORTHVILLE**  
Located deep in the sub this home features kitchen with Sub Zero, skylights, wet bar and vaulted ceiling in great room, cathedral ceiling, wood plank floors and natural fireplace in family room, study with built-in shelves, ceramic tile in kitchen and foyer, paver patio and walkways, more. \$599,900.

**TOP OF THE LINE WITH IMMEDIATE OCCUPANCY IN NORTHVILLE**  
This detached condo features gourmet kitchen with custom 4 1/2 inch appliances, Sub Zero, vaulted ceiling and skylights; gas fireplace in great room with soaring vaulted ceiling; first floor master suite with cathedral ceiling, ceramic tile floors in foyer, kitchen and hallway; deck, new roof and roads. \$344,900

**TOP 1% NATIONWIDE IN SALES**  
My Success is Built on Putting My Customers First  
Service + Dedication = Results

**TRADE YOUR PLACE DESIGN A SPACE**

**Cedar Lake Apartments & Pier 1 imports**  
HAVE TEAMED UP TO DESIGN A SPACE IN YOUR NEW APARTMENT HOME!  
ABSOLUTELY FREE!!!

1 & 2 Bedroom Apartments 2 Bedroom Townhomes!

It's Free, It's Fun... It's DESIGNED just for you!

Call today for details and other pricing information!  
**248-348-1830**

Located on 6 mile between Haggerty and Northville Road, 2 miles west of I-275.

**BROOKWOOD FARMS**

Come Home to Our Town...

Affordable Move-ins!

- Single Family Homes
- Cathedral Ceilings\*
- Private Entrances
- Attached Garages Available
- In-home Washer/Dryer or Connections Available
- Clubhouse with Fitness Center
- Indoor, Outdoor Pool, & Hot Tub
- Some Pets Welcome\*
- Much, Much More!

**Move-Ins as low as \$150\***  
One Month Free\*\*  
**248-437-9959**

Ten Mile Road 3/4 Mile E. of Pontiac Trail  
New Winter Hours Mon & Thurs 8-6  
Tues, Wed & Fri 10-5 • Sat 10-2

\* In select apartments  
\*\* Limited time offer, some conditions apply

**Pets Welcome** Experience the Good Life!

**AFFORDABLE Luxurious Apartment Homes**  
Special 2 Months FREE Rent  
PLUS We will help pay your moving costs

- Burner Free Units Available
- Washer & Gas Dryer
- Dishwasher
- 2 Full Baths
- Full Service Club House
- Vaulted Ceilings
- Ceiling Fans
- Carpets Available
- Lighted Walks
- Pool
- Fitness Center
- Tennis Court
- Private Entrances

West of Lorton, North of Grand River  
Mon-Fri 10 a.m.-6:00 p.m. • Sat. 10-3 p.m. • Sun. by appt. only  
thegreatatlantidgrids.com  
**(517) 552-7868**

**SOUTH LYON**  
**FROM \$450**

**1 & 2 Bedrooms**  
Air Conditioning • Walk-in Closets  
Short-Term Leases • Close to I-96  
Across from Kensington Park  
FREE Annual Metro Park Pass

**Kensington Parks Apartments**  
(248) 437-6794  
conditions apply  
www.KaftanCommunities.com

**Quick Cash**

If you have something to sell, let the Green Sheet classifieds help you swing a deal.

www.hometownlife.com  
**1-888-999-1288**

**Green Sheet CLASSIFIEDS**

Illustration of a man in a suit holding a briefcase and a woman in a dress.

# Unwrap Your New Home for the Holidays!

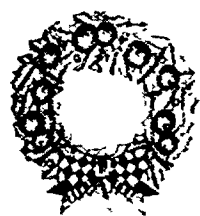

**HOME TOWN**  
Newspapers

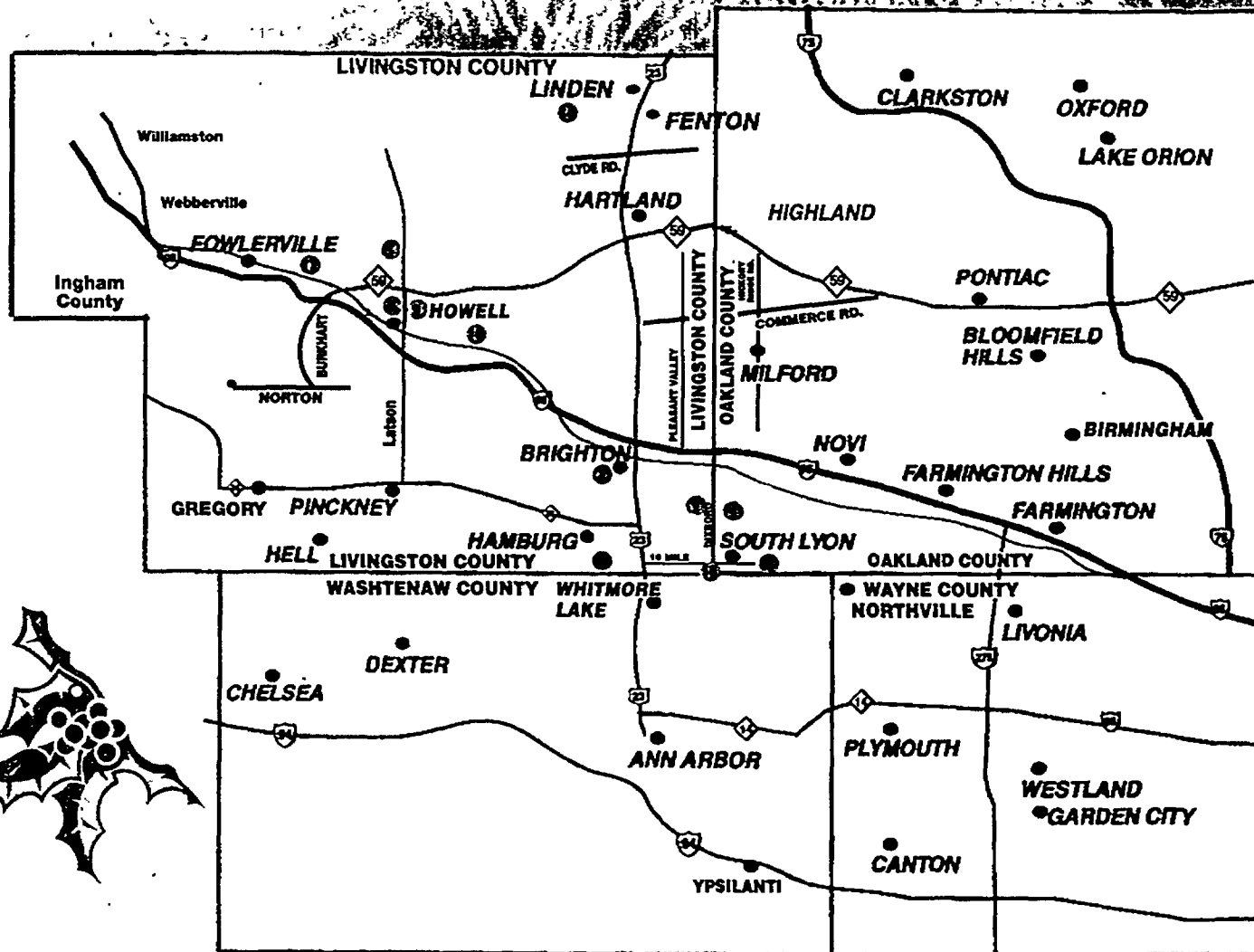

**1**

**LAVAN**  
ESTATES NORTH

**Custom Homes**  
Priced from \$271,900

South off 10 Mile  
between Rushton & Duxboro  
(248) 486-2930  
Tony Van Oyen  
Development, LLC  
www.tonyvanoyenbuilder.com

**2**

Your Ad  
Could Be  
Here

**3**

**CARRIAGE CLUB**

Homes Starting  
from the Low \$290's

East off of Martindale. Between  
10 and 11 Mile Roads.  
(248) 486-2985  
www.healyhomes.com

**4**

**Mystic  
Ridge**

South side of Strawberry Lake Rd.  
between Mast and Merrill Rd  
**Single Family Homes, Detached  
Condos and Retirement Cottages  
from the Mid 200's and Custom  
Estate Homes from the Low 500's**

Woodlands, Wetlands, Primes and  
Meadows cover 183 acres of this breath-  
taking 277 acre community  
734-449-4625  
www.mysticridge.com

**5**

**CLOSE OUT!!!!**  
**Hickory Meadows  
Condominiums**  
810-735-0845

Location: North side of M-59,  
between Latson Rd. & Michigan Ave.  
Hurry In!!!! These Luxury Condos Won't Last!!!  
Only 2 units still remain - and they're walnuts!!!!

- Spacious 2 & 3 Bedroom
- Full Basement • Attached 2 Car Garage
- 1st Floor Laundry • Deck
- Fireplace • Central Air

2 Floor Plans to Choose From!

**6**

**The Villas  
of Ocoala**

Maintenance Free Ranch Condo's  
1400-1725 Sq.Ft.

Priced from the Low \$200's

Latson Rd. - 2 miles  
North of Grand River - West Side

866-68-**Pulte**  
**PULTE** Homes

**7**

**Brighton  
Lake Village**

Single Family Homes from 240's  
on Brighton Lake Road 1 Mile  
West of Grand River

**ADVANCE CRAFT  
HOME BUILDERS**  
(810)229-2752  
www.advancecraft.com

**8**

**WOODWIND  
GLEN**

Elegant Condominiums  
Starting in the 250's

Ten Mile Rd. just West of  
Johns Rd., Lyon Twp.

**248-486-7000**

A&M  
Curtis

**9**

**Hidden Creek**

Homes from the \$190's

- Community Pool & Tot-Let
- Walk-out & Garden views available
- Sed, sprinkler & landscaping on  
select homes closing by 12-31-04

\*See sales associate for details

Latson Rd. ~ 3 miles North of  
Grand River - East Side.

517-540-6900 **Pulte**

**10**

Your Ad  
Could Be  
Here

**11**

**Emerald  
State**

Fowlerville  
Single Family Homes  
from the 250's

Large Lots • 3 Car Garages  
4 Bedrooms - Huge Master Bedrooms

Closing Cost Rebates \*Restrictions Apply  
Grand River to Cemetery, North 1/4 Mile on Left

**810-632-9191**

Envision Builders, Inc. Arrada Homes  
810-632-9191 810-632-4399  
www.envisionbuilders.net www.arradahomes.net

**12**

Your Ad  
Could Be  
Here

**13**

Your Ad  
Could Be  
Here

**14**

**Harold  
Developments**

Well appointed single family  
traditional homes from \$150's.

Open Sun 12-5 and by appointment.  
US23 North to Exit 79, West on Silver  
Lake 7 miles, just past Argentine Road.

**Harold Developments, Inc.**  
810-735-1121  
www.harolddevelopments.com

**15**

Your Ad  
Could Be  
Here

**16**

**SUMMERFIELD  
PONTE**

Condo's Starting from \$178,900

Ranches and 1st floor masters  
full basements, 2 car garages

I-96 to Howell, Exit 141  
W. on Grand River, N. on Lawson Drive  
(517)548-9066  
www.healyhomes.com

**17**

Your Ad  
Could Be  
Here

**18**

**NICHWAGH RIDGE**

West off Dixboro Rd.  
Between 9 & 10 Mile

1/2 Acre Lots, Wooded & Walkout  
Homesites. Custom Homes

**248-486-2643**

A&M  
CUSTOM BUILT HOMES

To Feature Your New Homes or  
Development Call Sherry at: 517-548-7375  
srains@ht.homecomm.net

**HOME TOWN**  
Newspapers





# Thousands of Success Stories!

## LET US OPEN DOORS FOR YOU!

16 Offices to Serve You

www.CENTURY21Town-Country.com



**NOVI Welcome Home**  
Spacious open floor plan California style ranch. Great room with lots of windows. 2 fireplaces & 1st floor laundry. 3 bedrooms, 1.5 baths, 2.5 car garage w/overhead, crown moldings & Nov schools.

(F60TEN) 248-349-5600 \$194,900



**WEST BLOOMFIELD Great Value**  
Beautiful 4 bedroom, 3.5 bath colonial. Granite, 42" maple cabinets, custom hardwood, finished basement with bed, bath, kitchen & wooded cut-deck lot. 3 car garage. Great lot with plenty of room to play.

(F24MER) 248-349-5600 \$619,900



**CANTON Great Location**  
4 bedroom, 2.5 bath colonial w/cath ceilings, open floor plan & neutral carpet. All windows & doors done in rich oak. Finished basement ready for bath. Professionally landscaped, sprinklers, lighting, 2 car garage. Must see!

(F08WEL) 248-349-5600 \$325,000



**WYANDOTTE Updated With Plenty Of Charm**  
Newer Pergo flooring in kitchen & living room, 2 car garage, partially finished basement, spacious eat-in kitchen w/appliances. All this in this 3 bedroom, 2 full bath bungalow.

(F63ORC) 734-455-5600 \$131,000



**LIVONIA Outstanding Ranch**  
Full brick finished basement w/dormer kitchen & bath. Newer roof, windows, oak kitchen - above ground pool w/deck & 8 person hot tub all offered in this 3 bedroom, 2.5 bath home & 2.5 car garage.

(F22RAY) 734-455-5600 \$229,000



**SOUTH LYON Ranch Condo 55+**  
Centennial Farms end unit w/2 BRs & 2 full ceramic BAs. Extra sink in dressing area. Great view from dining room window. Newer dishwasher. Large patio. Single car garage. Enjoy clubhouse & beach on Crooked Lake.

(F52CAM) 248-349-5600 \$142,000



**NOVI Sharp**  
3 bedroom, 1.5 bath condo. Newer vinyl siding, ceramic baths & newer carpet. Nov schools. Swimming pool, tennis courts, clubhouse. All appliances included. Immediate occupancy. Assessment to be paid by sellers.

(F85BAS) 248-349-5600 \$135,000



**DEARBORN HEIGHTS Heights Beauty Is Born**  
2004 built full brick ranch w/3 bedrooms, 2 baths. Open flowing floor plan w/great attention to detail. Generous room sizes and large country kitchen. Central air, custom front porch. Ready in approx. 30 days.

(F81HAR) 248-349-5600 \$149,900



**CANTON Don't Miss This One!**  
New part in this lovely 3 bedrooms, 1.5 bath colonial condo. Kitchen has light cabs, pantry & breakfast bar. Spacious rooms, dining room overlooking common area, large basement & carpet.

(F74FRA) 734-455-5600 \$139,900



**PLYMOUTH Live Downtown**  
Historical 4 bedroom, 1.5 bath colonial w/all the modern updates. Hardwood floors, large family room w/brick fireplace, partially finished basement, open kitchen w/appl, lg fenced yard w/whenever deck.

(F18HOL) 734-455-5600 \$204,900



**LIVONIA Cape Cod**  
Lovely cape cod on huge shady lot in wonderful neighborhood. 3 bedrooms, 1.5 baths, 1st floor master, FR, oversized 2 car garage, updated kitchen and bath. Lots of potential.

(F64DEE) 248-349-5600 \$149,900



**NORTHVILLE Fantastic Blue Heron**  
This beauty overlooks the water and slates and has boat docks, overlooks lower level & is quality built. 3 bedrooms, 3.5 baths. The LL is teenage quarters for privacy. The neutral colors are appealing & flowing.

(F85BLU) 248-349-5600 \$372,900



**NOVI Entertain Indoors & Out**  
Pride in ownership. Custom kitchen & hearth room, stainless appls, brick paver patio (3), electric zoning, pool, putting green, Home DR, FR, gas generator, well for lawn, 3 1/2 car heated garage. Extra wide drive.

(F37HAZ) 248-349-5600 \$599,900



**GARDEN CITY Absolutely Fabulous**  
You won't find a cleaner, more cared for home. Newer construction w/popular split ranch floor plan w/3 BRs. Professionally finished LL, natural decor, newer Berber carpet, freshly painted, vinyl windows. Oak lot cabs.

(F21BEL) 734-455-5600 \$164,999

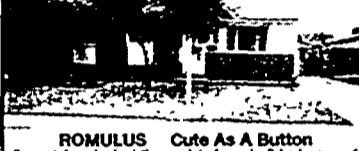

**ROMULUS Cute As A Button**  
Come take a look at this updated ranch. 3 bedrooms, 1 bath, partially finished basement, newer windows, fenced yard. Very clean and not too far from freeways & shopping.

(F03WAL) 734-455-5600 \$137,900

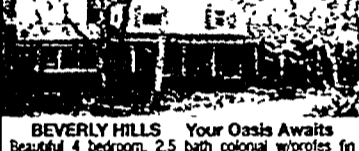

**BEVERLY HILLS Your Oasis Awaits**  
Beautiful 4 bedroom, 2.5 bath colonial w/porches fin bsmt, hwd flrs, newer roof, dramatic library, 2 fireplaces, open floor plan. All this setting on gorgeous approx 1 acre plus lot w/circular drive & park setting.

(F25EMB) 248-349-5600 \$399,900



**NORTHVILLE Stylish And Spacious**  
2 bedrooms, 2 baths, 2 lv end unit with walk-out. 2 car garage. Lots of updates. Close to downtown. Highly acclaimed schools. Great Value. Great investment.

(F44CON) 248-349-5600 \$199,000



**MILFORD Lakeview, Hillside Haven**  
4 bedroom, 2 bath home w/lake privileges, fireplace, wood stove in great room, updated kitchen cabinets & counter, deck & MBR overlook Sears Lake. Almost 3/4 acre wooded lot. Close to downtown Milford.

(F64PAR) 248-349-5600 \$174,900



**SOUTHFIELD Check Out This One**  
Almost new condo w/neutral walls & carpet, across from park setting w/vaulted ceilings, 2 skylights, great room & 21x13 loft area, kitchen w/white cabs & all appliances & attached garage w/porch.

(F50STO) 734-455-5600 \$147,000



**BELLEVILLE Beautiful Colonial**  
4 bedrooms, 2.5 baths, 2 car attached garage, 2 story foyer & GR, cathedral ceilings, hardwood 10 kitchen, Master bedroom w/cathedral ceiling & bath w/jetted tub & separate shower. Basement planned for 3 baths.

(F05WIL) 734-455-5600 \$265,000



**SOUTH LYON Great Home**  
Clean 2 bedroom, 1.5 bath ranch on double lot - third is wooded. Two car detached garage, heated porch & deck overlooking wooded yard. Some updates, newer carpet and kitchen floor. Appliances stay. Take a look.

(F38DOM) 248-349-5600 \$179,900

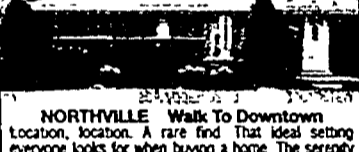

**NORTHVILLE Walk To Downtown**  
Location, location. A rare find. That ideal setting everyone looks for when buying a home. The serenity and comfort of living in a private court location. A hot, hot & a jump to downtown. Hwd flrs under carpeting.

(F78FAU) 248-349-5600 \$229,000



**LIVONIA Beauty & Warmth**  
3 bedroom, 2 bath brick ranch w/large fenced yard. Living room with fireplace to deck & brick paver patio. Hardwood floors 10. Remodeled bath, finished basement with BR or office. 2 car garage.

(F56SUN) 248-349-5600 \$199,500



**MILFORD New Construction**  
Pick your colors in this lovely 4 bedroom, 2.5 bath colonial w/2 car attached garage, basement, studio ceiling in family room & vaulted ceiling in master bedroom.

(F63TUR) 734-455-5600 \$284,900



**DEARBORN Super Sharp Ranch**  
2 bedroom, 1 bath ranch, roomy living room, separate dining room w/Pergo floor, updated bath, newer kitchen floor, 2.5 car garage w/newer roof. Vinyl windows.

(F62DAR) 734-455-5600 \$110,000



**NORTHVILLE Spectacular Colonial**  
Huge 4 bedroom, 2.5 bath home w/enormous gourmet kitchen w/multiple cabs and hardwood floors. Winding staircase, MBR w/master BA & WIC, 2 fireplaces 3 car garage, W/O basement & dual heating & cooling.

(F65HIL) 248-349-5600 \$679,900

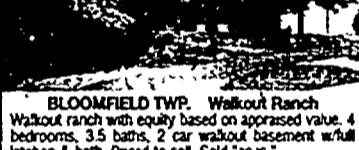

**BLOOMFIELD TWP Walkout Ranch**  
Walkout ranch with equity based on appraised value. 4 bedrooms, 3.5 baths, 2 car walkout basement w/full kitchen & bath. Priced to sell. Sold "as is".

(F91KEN) 248-349-5600 \$298,400



**NOVI Nothing Could Be Finer**  
Charming 2 bedroom, 2 bath ranch overlooking a lake-like pond offers gas fireplace, C/A, basement, patio, some appliances, hickory hardwood floors.

(F07PON) 734-455-5600 \$218,000



**WESTLAND Country In The City**  
2 lots give you almost 1 acre of gorgeous landscaping & your own wooded park. 1st floor master bedroom, 2nd and 3rd bedroom on 2nd floor, newer roof, windows & siding. Large full clean basement. Spottless.

(F60VAN) 734-455-5600 \$127,900



**LIVONIA Move In Condition**  
Super brick ranch 3 bedrooms, 2 baths, office, LR, FR, large deck, 2 car garage, deck, beautiful landscaping completely redecorated to update: windows, C/A, H2O, BBW, carpet, paint, kitchen fixtures window trims.

(F00MIN) 734-455-5600 \$179,850



**NORTHVILLE Downtown Northville**  
2 bedroom home w/formal DR, large LR, FR w/vaulted ceiling & gas fire. Updated kitchen, heated porch & deck overlooking wooded yard. A/C. Basement & 1 car attached garage. This home is on a lot that has a CBD zoning.

(F14RAY) 248-349-5600 \$274,900



**SOUTH LYON This Is A Charmer**  
Brick home w/newer roof, windows, lot, bath, deck, fresh paint, lot in front. Great location in sub. Fully fenced lot w/private backyard & 2 car garage. Ceramic tile baths plus hwd flrs 10. Award winning S. Lyon Schs.

(F23LYO) 248-349-5600 \$183,000



**FARMINGTON HILLS A Home For All Seasons**  
3 bedrooms, 1.5 baths, extra shower stall, C/A, large eat-in kitchen w/fireplace in family room, nice down-stair to patio, oversized 2 car garage, shed for extra storage, newer windows, electrical panel & bath fixtures.

(F19CRE) 734-455-5600 \$211,500



**INKSTER Wonderful Find**  
Brick home in peaceful location. Updates include: roof, 3 bedrooms, finished basement, garage, many updates & porch. All updates are energy efficient. Nice fenced yard w/great landscaping.

(F83ARL) 734-455-5600 \$103,900



**GARDEN CITY Super Clean Bungalow**  
Updated 3 bedroom bungalow, nicely finished basement w/4th bedroom & additional living space! 2 car garage w/workshop & 220

(F21RUS) 734-455-5600 \$139,900



**LIVONIA Move In & Enjoy!**  
All the big ticket items are done. This 3 bedroom ranch features bay window, re-modeled kitchen, updated baths, new 04 tear off roof, newer furnace, A/C, FR w/fireplace, 2 car garage & basement. Super location.

(F48SCH) 248-349-5600 \$212,000

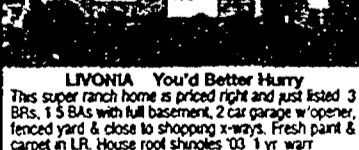

**LIVONIA You'd Better Hurry**  
This super ranch home is priced right and just listed 3 BRs, 1.5 BAs with full basement, 2 car garage w/open, fenced yard & close to shopping x-ways. Fresh paint & carpet in LR. House roof shingles 03 1 yr warr.

(F61OXE) 248-349-5600 \$149,900



**NOVI Rare Find In Novi**  
Updated 3 bedroom, 1.5 bath ranch w/family room, living room & a den. Private 2 tier deck, hardwood under carpet, finished basement, master bath updated w/ceramic tile. Newer vinyl windows & flooring in kit.

(F05MEA) 734-455-5600 \$234,900



**TAYLOR Don't Miss This One!**  
Newer construction condo opens to a 2 story foyer. Beautiful gas fireplace, master bedroom w/WIC & vaulted ceiling. Features C/A, 2 car attached garage & carpeted basement.

(F78COA) 734-455-5600 \$172,000



**WESTLAND Premium Lot!**  
Wonderful 3 bedroom, 2.5 bath colonial built in 2000 presents 2 car attached garage, basement, spacious kitchen opens to family room w/fireplace & sliding door to brick paver patio. All backing to nature preserve.

(F15CRA) 734-455-5600 \$225,000



**NOVI Condo With Lake Access**  
Great Value. Ground level unit with handicap access. Clean & bright. Extra large bedroom, neutral decor. View of woods. Lake privileges to Walked Lake. South Pointe Condo's an adult community 55 years +.

(F55SOU) 248-349-5600 \$95,990



**WESTLAND Great Location**  
3 bedroom, 1.5 bath ranch. Partially finished basement w/2 bath. Eat-in kitchen & dining area. Fully fenced rear yard with patio. Low maintenance exterior. House roof in March of 04.

(F90STI) 248-349-5600 \$131,900



**WESTLAND Recently Remodeled Brick Ranch**  
Remodeled kitchen & bath, re-finished hardwood floors, newer roof, windows, cement, plumbing & electric. Service all offered in this 3 bedroom, 1.5 bath home w/2 car garage & finished bsmt w/office space.

(F51BIR) 734-455-5600 \$139,900

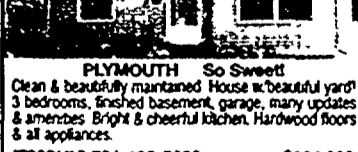

**PLYMOUTH So Sweet**  
Clean & beautifully maintained house w/beautiful yard! 3 bedrooms, finished basement, garage, many updates & amenities. Bright & cheerful kitchen. Hardwood floors & all appliances.

(F80SUM) 734-455-5600 \$234,900

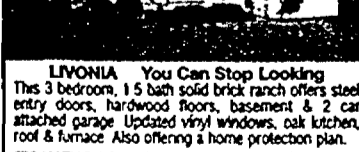

**LIVONIA You Can Stop Looking**  
This 3 bedroom, 1.5 bath solid brick ranch offers steel entry doors, hardwood floors, basement & 2 car attached garage. Updated vinyl windows, oak kitchen, FR & furnace. Also offering a home protection plan.

(F01NEW) 734-455-5600 \$197,325



**REDFORD South Redford Ranch**  
3 bedroom, 2 bath, large kitchen, hardwood floors, newer windows, updated furnace, A/C, HWI, finished basement, glass block windows. Newer roof, storage shed, nicely landscaped & deck. Needs your decorating.

(F10WES) 248-349-5600 \$144,900



**WESTLAND Gorgeous Ranch**  
1990 built 3 bedroom, 2 bath home w/large lot & pantry. Ceramic flrs, crown molding & newer vinyl windows in 02. Finished basement w/full bath & possible 4th bedroom, 2.5 car garage, sprinkler system & more.

(F25UNJ) 248-349-5600 \$167,500

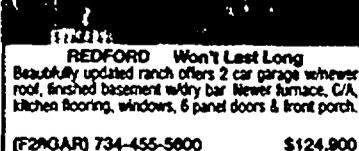

**REDFORD Won't Last Long**  
Beautifully updated ranch offers 2 car garage w/newer furnace, finished basement w/dry bar. Newer furnace, C/A, kitchen flooring, windows, 6 panel doors & front porch.

(F29GAR) 734-455-5600 \$124,900



**PLYMOUTH Nestled In The Woods**  
Very private setting, 2 bedroom, 2 bath condo. Large living room & dining room w/corner fireplace, FR, 2 private store rooms in basement. Beautiful oak cabs w/all appls to stay. Neutral decor. Deck, beautiful setting.

(F48SYC) 734-455-5600 \$149,900



**GARDEN CITY New Community**  
Very nice detached condo ranch w/2 full baths, fireplace, daylight windows in basement, 2 car attached garage, spacious floor plan, dining room, kitchen w/snack bar. Pleasure to show! Builder pays tax!

(F26BIR) 734-455-5600 \$184,900



Relocation Services  
800-448-5817



- |                            |                               |                                  |                             |                                   |                              |                        |                                  |
|----------------------------|-------------------------------|----------------------------------|-----------------------------|-----------------------------------|------------------------------|------------------------|----------------------------------|
| Birmingham<br>248-642-8100 | Clarkston<br>248-620-7200     | Commerce Twp.<br>248-363-1200    | Northville<br>248-349-5600  | Rochester<br>248-652-8000         | Royal Oak<br>248-280-4777    | Troy<br>248-524-1600   | West Bloomfield<br>248-626-8800  |
| Plymouth<br>734-455-5600   | Grosse Pointe<br>313-886-5040 | St. Clair Shores<br>586-778-8100 | Shelby Twp.<br>586-731-8180 | Chesterfield Twp.<br>586-949-5500 | Clinton Twp.<br>586-286-6000 | Frazer<br>586-294-3655 | Sterling Heights<br>586-936-2900 |





Help Wanted Medical 5060

Help Wanted Medical 5060

Help Wanted Food/Beverage 5080

Help Wanted Sales 5120

Help Wanted Sales 5120

Help Wanted Sales 5120

Help Wanted Sales 5120

Help Wanted Sales 5120

Help Wanted Sales 5120

MIDNIGHT NURSE, part time needed. Apply in person...

RESIDENT ASSISTANTS Needed for Elderly Care in Brighton...

MR. B'S IS NOW HIRING! Exp. Line Cooks, Day Host & Servers...

COOKS POSITIONS & ASSISTANT KITCHEN MANAGER

A NEW CAREER! Booming real estate offices in Northville & Livonia...

NATIONAL SALES MANAGER \$200K. First yr. potential, very selective...

STOP LOOKING for a job! Find a career. A growing insurance agency in Brighton/Howell...

ACCOUNT EXECUTIVE The award-winning Observer & Eccentric Newspaper is looking for a driven, results-oriented sales professional...

BASES NEEDED South Lyon Home of Compassionate Care is currently looking for a part time afternoon nurse...

APPLY NOW! Waitstaff, Full/part-time. We will train. Benefits, too!

BANQUET CHEF NEEDED Must be exp. Part/Full time. Great place to work.

REAL ESTATE CAREER Building Expansion! Doubling in Size!

SELL THE AMERICAN DREAM Real Estate is Booming! We're looking for self-directed individuals...

START YOUR exciting career in Real Estate with us! We are seeking energetic self-starters...

OFFICE CLERICAL Full & Part-time Days & Evenings Apply in person...

ATTN. OWN A COMPUTER? Put it to work. Up to \$1500 to \$7500/mo. PT/FT...

RESIDENTIAL ASSISTANTS Willowbrook Rehabilitation provides all disciplines of out-patient rehabilitation...

CAKE BAKER Fine Pastries (No Breads) Elite Sweets, Livonia

UP SCALE JAPANESE RESTAURANT IN NOVI COMING IN MID DECEMBER

A NEW CAREER? REAL ESTATE IS BOOMING! Excellent Commissions Great Training...

Real Estate Agent Busy Re/Max mega agent needs licensed agent...

SALES PERSON For carpet store. Must be able to do estimating, blueprints & scheduling...

Position Wanted \$340 WILL CARE FOR YOUR ELDER Live-in, experienced Affordable price...

Childcare Services Licensed ALL ADS APPEARING UNDER THIS CLASSIFICATION MUST BE PREPAID

CAKE BAKER Fine Pastries (No Breads) Elite Sweets, Livonia

UP SCALE JAPANESE RESTAURANT IN NOVI COMING IN MID DECEMBER

A NEW CAREER? REAL ESTATE IS BOOMING! Excellent Commissions Great Training...

REAL ESTATE CAREER Building Expansion! Doubling in Size!

SELL THE AMERICAN DREAM Real Estate is Booming! We're looking for self-directed individuals...

START YOUR exciting career in Real Estate with us! We are seeking energetic self-starters...

OFFICE CLERICAL Full & Part-time Days & Evenings Apply in person...

ATTN. OWN A COMPUTER? Put it to work. Up to \$1500 to \$7500/mo. PT/FT...

RESIDENTIAL ASSISTANTS Willowbrook Rehabilitation provides all disciplines of out-patient rehabilitation...

CAKE BAKER Fine Pastries (No Breads) Elite Sweets, Livonia

UP SCALE JAPANESE RESTAURANT IN NOVI COMING IN MID DECEMBER

A NEW CAREER? REAL ESTATE IS BOOMING! Excellent Commissions Great Training...

Real Estate Agent Busy Re/Max mega agent needs licensed agent...

SALES PERSON For carpet store. Must be able to do estimating, blueprints & scheduling...

Position Wanted \$340 WILL CARE FOR YOUR ELDER Live-in, experienced Affordable price...

Childcare Services Licensed ALL ADS APPEARING UNDER THIS CLASSIFICATION MUST BE PREPAID

CAKE BAKER Fine Pastries (No Breads) Elite Sweets, Livonia

UP SCALE JAPANESE RESTAURANT IN NOVI COMING IN MID DECEMBER

A NEW CAREER? REAL ESTATE IS BOOMING! Excellent Commissions Great Training...

REAL ESTATE CAREER Building Expansion! Doubling in Size!

SELL THE AMERICAN DREAM Real Estate is Booming! We're looking for self-directed individuals...

START YOUR exciting career in Real Estate with us! We are seeking energetic self-starters...

OFFICE CLERICAL Full & Part-time Days & Evenings Apply in person...

ATTN. OWN A COMPUTER? Put it to work. Up to \$1500 to \$7500/mo. PT/FT...

CAKE BAKER Fine Pastries (No Breads) Elite Sweets, Livonia

UP SCALE JAPANESE RESTAURANT IN NOVI COMING IN MID DECEMBER

A NEW CAREER? REAL ESTATE IS BOOMING! Excellent Commissions Great Training...

REAL ESTATE CAREER Building Expansion! Doubling in Size!

SELL THE AMERICAN DREAM Real Estate is Booming! We're looking for self-directed individuals...

START YOUR exciting career in Real Estate with us! We are seeking energetic self-starters...

OFFICE CLERICAL Full & Part-time Days & Evenings Apply in person...

ATTN. OWN A COMPUTER? Put it to work. Up to \$1500 to \$7500/mo. PT/FT...

SERVICE DIRECTORY

Reach over 54,000 households with your business message every week

Service Guide 1-800-298-0010. Includes categories: Accounting, Advertising, Air Conditioning, Alarm & Security, Aluminum Cleaning, etc.

Categories: Bathroom Refinishing, Bicycle Maintenance/Repair, Blind Cleaning, Boat Repair, etc.

Categories: Delivery/Courier Service, Dry Cleaning, Drywall, Electrical, etc.

Categories: Greenhouses, Gutters, Handyman M/F, Heating/Cooling, etc.

Categories: Home Inspection, Housecleaning, Landscaping, Plumbing, etc.

0010-2980 SERVICE GUIDE Brick, Block & Cement

Carpet Repair/Installation 4440 CARPET INSTALLATION

Excavating/Backhoe 0730 POND CONSTRUCTION

Handyman M/F 1020 General InHome Maintenance

Housecleaning 1080 GUARANTEED old fashioned cleaning

Landscaping 1210 PINES, SPRUCES Large selection

Plumbing 1480 Celebrating 55 Years

Road Grading 1638 K.B. ROAD GRADING

Snow Removal 1810 SNOW PLOWING and SALTING

ALL BRICK REPAIRS Chimney, porches, pick pointing

Ceiling Work 0470 BASEMENT SPECIALIST

Excavating/Backhoe 0730 POND CONSTRUCTION

Handyman M/F 1020 General InHome Maintenance

Housecleaning 1080 GUARANTEED old fashioned cleaning

Landscaping 1210 PINES, SPRUCES Large selection

Plumbing 1480 Celebrating 55 Years

Road Grading 1638 K.B. ROAD GRADING

Snow Removal 1810 SNOW PLOWING and SALTING

BASEMENT DESIGN & CONSTRUCTION Finished basements within your budget

C.C.A. Inc. COMPUTER • REPAIRS • UPGRADES NETWORK CONSULTING AND INSTALLATION

Excavating/Backhoe 0730 POND CONSTRUCTION

Handyman M/F 1020 General InHome Maintenance

Housecleaning 1080 GUARANTEED old fashioned cleaning

Landscaping 1210 PINES, SPRUCES Large selection

Plumbing 1480 Celebrating 55 Years

Road Grading 1638 K.B. ROAD GRADING

Snow Removal 1810 SNOW PLOWING and SALTING

BUSY B'S REMODELING Contractor Lic & Ins Kitchens, baths, bsmts & ins repairs

Computer Sales & Service 0540

Excavating/Backhoe 0730 POND CONSTRUCTION

Handyman M/F 1020 General InHome Maintenance

Housecleaning 1080 GUARANTEED old fashioned cleaning

Landscaping 1210 PINES, SPRUCES Large selection

Plumbing 1480 Celebrating 55 Years

Road Grading 1638 K.B. ROAD GRADING

Snow Removal 1810 SNOW PLOWING and SALTING

DEEDLER CONSTRUCTION Quality framing, cust. homes, add's, decks, barns, garages

Drywall 0690

Excavating/Backhoe 0730 POND CONSTRUCTION

Handyman M/F 1020 General InHome Maintenance

Housecleaning 1080 GUARANTEED old fashioned cleaning

Landscaping 1210 PINES, SPRUCES Large selection

Plumbing 1480 Celebrating 55 Years

Road Grading 1638 K.B. ROAD GRADING

Snow Removal 1810 SNOW PLOWING and SALTING

FRIENDLY Master Electrician handles all electrical wiring in res comm & industrial applications

Firewood 0840

Excavating/Backhoe 0730 POND CONSTRUCTION

Handyman M/F 1020 General InHome Maintenance

Housecleaning 1080 GUARANTEED old fashioned cleaning

Landscaping 1210 PINES, SPRUCES Large selection

Plumbing 1480 Celebrating 55 Years

Road Grading 1638 K.B. ROAD GRADING

Snow Removal 1810 SNOW PLOWING and SALTING

LEES HOME IMPROVEMENT Bsm't, kitchen, bath remodel. Decks, garages, additions

Firewood 0840

Excavating/Backhoe 0730 POND CONSTRUCTION

Handyman M/F 1020 General InHome Maintenance

Housecleaning 1080 GUARANTEED old fashioned cleaning

Landscaping 1210 PINES, SPRUCES Large selection

Plumbing 1480 Celebrating 55 Years

Road Grading 1638 K.B. ROAD GRADING

Snow Removal 1810 SNOW PLOWING and SALTING

PATTON ELECTRIC Homes new & old. Service. 810-231-5400

Firewood 0840

Excavating/Backhoe 0730 POND CONSTRUCTION

Handyman M/F 1020 General InHome Maintenance

Housecleaning 1080 GUARANTEED old fashioned cleaning

Landscaping 1210 PINES, SPRUCES Large selection

Plumbing 1480 Celebrating 55 Years

Road Grading 1638 K.B. ROAD GRADING

Snow Removal 1810 SNOW PLOWING and SALTING

REMEDIATION AND RESTORATION

Firewood 0840

Excavating/Backhoe 0730 POND CONSTRUCTION

Handyman M/F 1020 General InHome Maintenance

Housecleaning 1080 GUARANTEED old fashioned cleaning

Landscaping 1210 PINES, SPRUCES Large selection

Plumbing 1480 Celebrating 55 Years

Road Grading 1638 K.B. ROAD GRADING

Snow Removal 1810 SNOW PLOWING and SALTING

SANTA FOR HIRE

Firewood 0840

Excavating/Backhoe 0730 POND CONSTRUCTION

Handyman M/F 1020 General InHome Maintenance

Housecleaning 1080 GUARANTEED old fashioned cleaning

Landscaping 1210 PINES, SPRUCES Large selection

Plumbing 1480 Celebrating 55 Years

Road Grading 1638 K.B. ROAD GRADING

Snow Removal 1810 SNOW PLOWING and SALTING

THE WALLPAPER MAN

Firewood 0840

Excavating/Backhoe 0730 POND CONSTRUCTION

Handyman M/F 1020 General InHome Maintenance

Housecleaning 1080 GUARANTEED old fashioned cleaning

Landscaping 1210 PINES, SPRUCES Large selection

Plumbing 1480 Celebrating 55 Years

Road Grading 1638 K.B. ROAD GRADING

Snow Removal 1810 SNOW PLOWING and SALTING

THE WALLPAPER MAN

Firewood 0840

Excavating/Backhoe 0730 POND CONSTRUCTION

Handyman M/F 1020 General InHome Maintenance

Housecleaning 1080 GUARANTEED old fashioned cleaning

Landscaping 1210 PINES, SPRUCES Large selection

Plumbing 1480 Celebrating 55 Years

Road Grading 1638 K.B. ROAD GRADING

Snow Removal 1810 SNOW PLOWING and SALTING

THE WALLPAPER MAN

Firewood 0840

Excavating/Backhoe 0730 POND CONSTRUCTION

Handyman M/F 1020 General InHome Maintenance

Housecleaning 1080 GUARANTEED old fashioned cleaning

Landscaping 1210 PINES, SPRUCES Large selection

Plumbing 1480 Celebrating 55 Years

Road Grading 1638 K.B. ROAD GRADING

Snow Removal 1810 SNOW PLOWING and SALTING

THE WALLPAPER MAN

Firewood 0840

Excavating/Backhoe 0730 POND CONSTRUCTION

Handyman M/F 1020 General InHome Maintenance

Housecleaning 1080 GUARANTEED old fashioned cleaning

Landscaping 1210 PINES, SPRUCES Large selection

Plumbing 1480 Celebrating 55 Years

Road Grading 1638 K.B. ROAD GRADING

Snow Removal 1810 SNOW PLOWING and SALTING

THE WALLPAPER MAN

Firewood 0840

Excavating/Backhoe 0730 POND CONSTRUCTION

Handyman M/F 1020 General InHome Maintenance

Housecleaning 1080 GUARANTEED old fashioned cleaning

Landscaping 1210 PINES, SPRUCES Large selection

Plumbing 1480 Celebrating 55 Years

Road Grading 1638 K.B. ROAD GRADING

Snow Removal 1810 SNOW PLOWING and SALTING

THE WALLPAPER MAN

Firewood 0840

Excavating/Backhoe 0730 POND CONSTRUCTION

Handyman M/F 1020 General InHome Maintenance

Housecleaning 1080 GUARANTEED old fashioned cleaning

Landscaping 1210 PINES, SPRUCES Large selection

Plumbing 1480 Celebrating 55 Years

Road Grading 1638 K.B. ROAD GRADING

Snow Removal 1810 SNOW PLOWING and SALTING

THE WALLPAPER MAN

Firewood 0840

Excavating/Backhoe 0730 POND CONSTRUCTION

Handyman M/F 1020 General InHome Maintenance

Housecleaning 1080 GUARANTEED old fashioned cleaning

Landscaping 1210 PINES, SPRUCES Large selection

Plumbing 1480 Celebrating 55 Years

Road Grading 1638 K.B. ROAD GRADING

Snow Removal 1810 SNOW PLOWING and SALTING



Childcare/Baby Sitting Services \$370

Business Opportunities \$740

Business Opportunities \$740

Absolutely Free 7000

Auction Sales 7060

ALL ADS APPEARING UNDER THIS CLASSIFICATION MUST BE PREPAID

CASH BUSINESS \$ With Hershey/Nestle vending equipment. Exc. profit potential. Great tax write off. \$5K. Call (810) 599-1733.

GREAT BOOKS, Great Earning Opportunity. Let the earning begin for you with Family Books featuring DK books. Call toll free 1-877-225-0644

Artificial Christmas Tree, 6.5' Green Valley Norway Spruce with stand. (248)348-5940

You can view and print all our auctions from our website. Listed below: Braun & Helmer Auction Service, Inc. (734) 865-9646 • (734) 996-8135 (734) 994-6399 • (734) 429-1919 www.braunandhelmer.com

CHILD CARE for children ages 12 mos. & up. Flexible hours. New Hudson area. Latch Key for Kent Lake. (248) 486-1348

ABSOLUTE GOLD MINE! 80 Machines + Locations! ALL FOR \$10.300 1-800-344-1277

6000-6780 ANNOUNCEMENTS Arrangements & Notices \$200

ATTENTION: PET LOVERS. HomeTown Newspapers discourages ads which offer pets for free. HomeTown Newspapers suggest you charge a nominal price for your pets. If offered for free the ads may draw response from individuals who might use your animal for research, breeding or other purposes. Please be sure to screen respondents carefully. Your pet will thank you!

Rummage Sale/ Flea Market 7080

Childcare Needed \$380

ALL ADS APPEARING UNDER THIS CLASSIFICATION MUST BE PREPAID

PLACE YOUR OWN CLASSIFIED AD ON-LINE. Check out our website, www.888-999-1288.com

Breeding stock meat rabbits & roosters. 2 Fuzzy Mini-Lops. Fowlerville (517)223-7566

ALL ADS APPEARING UNDER THIS CLASSIFICATION MUST BE PREPAID

SEEKING QUALIFIED NANNY with 3+ yrs exp in child care. Call Faith 877-Nanny80

ALL CASH CANOY ROUTE Do you earn up to \$800/day? Your own local candy route. Includes 30 machines and Candy. All for \$9,995 Call 1-800-814-6472.

READERS: SINCE many ads are from outside the local area, please know what you are buying before sending money.

CALICO needs loving home. Also white calico 1 yr spayed 810-735-5861.

7000 Estate Sales 7100

CARING, COMPASSIONATE, Loving CAREGivers needed... Looking for CAREGivers for part time nights & weekends to assist the elderly with companionship & home help. Days also available.

ARE YOU MAKING \$1710 per week? All cash vending routes with prime locations available now! Under \$9000 investment required. Call Toll Free (24-7) 800-637-7444

FREE OUTDOOR BUNNY RABBIT & HUTCH. (810) 220-2724

18,000 Sq. Ft. Estate Sale? Only Here at KBC. THE FINEST MERCHANDISE New & Used Furs, Furniture, Clothing, Antiques, Acces Lay-Away & Delivery. KNIGHTSBRIDGE - The Charity that gives back to your community 248-967-4901, 21310 Greenfield Road, Oak Park, MI 48237, across from Northland

ALL ADS APPEARING UNDER THIS CLASSIFICATION MUST BE PREPAID

HOME INSTEAD SENIOR CARE Clarkson & Walled Lake (248)623-0841

CHANGE YOUR CAREER in six months. Blue Heron Academy offers classes in Massage Therapy. Enroll now! Call for a free catalog 616-285-9999 toll free 888-285-9989 or visit www.blueheronacademy.com

FREE KITTEN 10 wk. male, med hair, orange w/whites. Very Loveable. 810-750-1447

FREE KITTENS, tan/white & orange/white, med hair, 8 wks, litter trained. 517-540-6070

ALL ADS APPEARING UNDER THIS CLASSIFICATION MUST BE PREPAID

ALTERNATIVE High School Part-time, MI certified teacher to teach Computer classes. Fax resume to apply: 248-573-8167. Pay \$21-\$24 per hr. For information call (248) 573-8165.

GREAT BOOKS, Great Earning Opportunity! Let the earning begin for you with Family Books featuring DK books. Call toll free 1-877-230-3062.

FREE KITTENS: 2 black, 2 gray, 1 tiger stripe, 10 wks, litter trained. 517-552-2731

FRIDGE - Runs. Minford area. You pick up (248) 676-9465

ALL ADS APPEARING UNDER THIS CLASSIFICATION MUST BE PREPAID

MUSIC LESSONS Master's degree. Piano, organ, voice, guitar, strings, reeds. WEDDINGS 248-363-6233.

READERS: SINCE many ads are from outside the local area, please know what you are buying before sending money

ALL ADS APPEARING UNDER THIS CLASSIFICATION MUST BE PREPAID

Hammond Model 5124 Organ, you haul. Call (248) 366-1003

CHERYL & COMPANY ESTATE SALE Dec. 2-4, 10am-4pm 8944 LENORE, REDFORD W. of Telegraph, N. of Joy 60 years of treasures, full house, basement & garage Duncan Phyfe dining room, old accordion & wheelchairs. Frame for hydroplane (734) 753-5883.

Auction Sales 7060

Auction Sales 7060

Don & Mary White Living Estate AUCTION Saturday, December 4 @ 10:00 am (preview 9:00 am) 1-96 to Howell/D-19 exit #137, north 1-1/2 miles to Grand River Ave., west 2 blocks to Center St., south to 425 S. Center St., Howell. www.narhiauctions.com FURNITURE, COLLECTIBLES & SEWING MACHINES Washer, dryer, cherry rocker, recliners, china cabinet, bookshelves, Victorian table; bow-back chairs; wing-back rocker w/ottoman; dressing mirror; pine child-size table; sleeper sofa; Victorian commode; twin beds; soup tureens; Revereware; old child's books; Christmas decorations; Featherweight sewing machine & table; New Home sewing machine; 1932 National Duolian steel body Guitar; 5 Hanging lamps (from Goodnows, Howell); Don White original oils; Remington .22 single shot (belonged to Olds Anderson); Hall tea pots; Currier & Ives dishes; Aladdin oil lamp base; victrola records; smoking pipe collection; English tea leaf dishes; tea cups; vases (Hull, crystal, satin glass, cobalt, ruby, dolls; Stief Rabbit; Roseville sconce, porcelain wash tubs; costume jewelry; records (lots of old country); 2 Beattles serving trays. Clocks: Superior 8-day wall; art deco key; 8 cuckoo; mantle; anniversary-style. LAWN TRACTORS, SNOWBLOWERS & TOOLS: Lawn tractors (JD STX38, JD 176 Hydro w/bagger); snow blowers (Toro 421, JD 322), leaf blower; chain saw; roll-around toolbox; grinder; drill press; mini air compressor; scroll saw; band saw; buffer; sander; table saw; hand tools; Radio Flyer wagon; bike; ladders. MANY OTHER ITEMS. Terms: Complete payment auction day. Credit cards, MI checks w/ID, Cash. All items sold "as is." Announcements take precedence over printed matter. Other terms apply. Tim Narhi Auctioneer & Associates (810) 266-6474 Byron, MI

Prayer to the Blessed Virgin, (Never known to fail. On the most beautiful flower of Mt. Carmel, fruitful vine, splendour of Heaven, Blessed Mother of the Son of God, Immaculate Virgin, assist me in my necessary. Oh, Star of the Sea help me, and show me here you are and show me here you are my Mother, Oh, Holy Mary, Mother of God, Queen of Heaven and Earth, I humbly beseech you from the bottom of my heart to succour me in my necessity. Home (make request). There are none that can withstand your power. Oh, Mary, conceived without sin, I pray for us who have recourse to thee, (3 times) Holy Mary, I place this prayer in your hands (3 times) Say this prayer for 3 consecutive days and then you must publish and it will be granted to you Grateful thanks J.

LAB/DACHSHUND mix spayed female, 7 mo. old, loves kids, housebroken. 810-422-4329

ALL ADS APPEARING UNDER THIS CLASSIFICATION MUST BE PREPAID

MOVING-Awesome call needs great home, neutered male, loving, playful 517-672-6088

NOVI Indoor Garage Sale: 8-1 Thurs. & Fri., Dec. 9-10, 41516 Fawn Trail, 9 Mile & Meadowbrook. White Simmons crib, 2 gym mats, 20" Giant 12-speed bike, tool boxes, toys, household misc 248-347-6712

ALL ADS APPEARING UNDER THIS CLASSIFICATION MUST BE PREPAID

PREPARED Scottish Fold Tabby cat, neutered, 4 yrs. old, all shots 517-546-7552

RAM & EWE - Very friendly You pick up. Howell area (517) 548-3499

ALL ADS APPEARING UNDER THIS CLASSIFICATION MUST BE PREPAID

SEARS KENMORE WASHER, almond, works, you haul Milford 248-684-7761

TOILET COMPLETE, almond, & 2 storm doors Good cond You pick up. 248-722-1047

ALL ADS APPEARING UNDER THIS CLASSIFICATION MUST BE PREPAID

YOUNG ADULT rescue cats All medical complete. Home delivery (248) 889-9328

Antiques/Collectibles 7020

ALL ADS APPEARING UNDER THIS CLASSIFICATION MUST BE PREPAID

Antiques Bought! Postcards, paper dolls, dishes, perfume bottles, Shelley bone china, factory badges. 248-624-3385

BARN SALE, RAIN OR SHINE! 1st & 2nd Sat. of Dec., 12/4, 8am-6pm, 12/11, 9am-6pm. Shop for Christmas: MSU/UM lamps/Christmas decorations, pub table & stools, Bodeweser mirrors, collectibles, gifts, Nascar & Harley bar items, etc 1664 Fowerville Rd, Fowerville, 196, Exit 129, S 1.5 miles (517) 223-1439

MINI COAT, full length (natural) mahogany size 6: \$700 Perfect cond (810)229-6498

Grebe Synchrophase Radio, \$250; N1300 CG Telephone set, \$245. (248)887-5665

SHIPSHEWANA ON THE ROAD comes to Lansing at the Lansing Center Saturday, December 4th from 9am to 6pm and Sunday, December 5th from 10am-5pm. \$3.00 adults, 12 and under Free. For more details and map to show see shipshewananootheroad.com or call 269-979-8888

MOVING. 1 yr. old washer & dryer, Whirlpool, 1 yr 5 cu ft. freezer; love seat, beige, 2 black swivel chairs & ottomans etc. 248-446-3571

TOY & HOBBY EXPO Dec. 3-5, New Expo Center Holiday Doll Show Dec. 12, Wayne Tree Manor. (734) 455-2110

Art & Crafts 7040

ALL ADS APPEARING UNDER THIS CLASSIFICATION MUST BE PREPAID

FRAMED OIL PAINTINGS. 3 country scenes, 24X36, \$115 20X24, 70X & 12X16, \$50 (248) 348-6913

HOLIDAY OPEN HOUSE Sat. Dec 4, 2004 11-6pm. Come see the following vendors: Pampered Chef, Avon, Tupperware & more 38692 Chestnut Drive, Northville

ALL ADS APPEARING UNDER THIS CLASSIFICATION MUST BE PREPAID

TREATS & TREASURES SALE Meadowbrook Church 21355 Meadowbrook, Novi On Sat., Dec 4th 9:30-2pm

Auction Sales 7060

ALL ADS APPEARING UNDER THIS CLASSIFICATION MUST BE PREPAID

ESTATE AUCTION, 12-4-04 Howell - Collectibles, furniture, snowblowers, tools www.narhiauctions.com

REDFORD No Reserve Auction. 3 bdrm. house for sale and all contents Appraisal 70K. Starting bid 29K. Dec. 5th 248-761-2603

ALL ADS APPEARING UNDER THIS CLASSIFICATION MUST BE PREPAID

5 piece oak computer desk, navy leather couch with reclining ends, antique buffet, motorized sewing machine cabinet, kitchen table set. Tel 517-546-8664

CEARWORKS SWINGSET SANDBOX CLIMBER SLANT See www.cedarworks.com New \$1795 - Asking \$875 00 Tel 810-231-3779

ALL ADS APPEARING UNDER THIS CLASSIFICATION MUST BE PREPAID

BEDROOM SET Armore, large dresser w/2 mirrors, matching queen size headboard, very nice, must see Solid wood, dark mediterranean. First \$400 or best offer takes it \*\*\*\*\*SOLD\*\*\*\*\*

WAREHOUSE CLEARANCE CENTER Floor Model Sale Sofas, bedroom sets, futons & mattress sets While supplies last Can deliver 248-921-8522

ALL ADS APPEARING UNDER THIS CLASSIFICATION MUST BE PREPAID

BEDROOM SET, Triple dresser w/mirror, king size bed w/headboard, good cond \$375 248-486-6029

BEDS -Going Out for Business Sale! All mattresses must go! Open to public. Dealers welcome 810-533-0740

ALL ADS APPEARING UNDER THIS CLASSIFICATION MUST BE PREPAID

BILLIARDS TABLE Brunswick Balke Collander, plus accessories. 8ft slate, 1940's leather pockets, very nice \$1,200 best 989-729-1851

Casement Windows/Greens, wood clad (9), \$200; 2 yr old Whirlpool super capacity washer \$200 (810) 220-3951

ALL ADS APPEARING UNDER THIS CLASSIFICATION MUST BE PREPAID

BROYHILL Br set, twin bed w/ mattresses, chest & dresser w/ mirror, \$250 (248) 684-9616

CONGRATULATIONS TO Lisa, of New Hudson Mark, of Howell Gary, of Novi Tony, of Fowlerville Graham, of South Lyon Neal, of Novi Lyanna, of Feiston Jeff, of Milford

ALL ADS APPEARING UNDER THIS CLASSIFICATION MUST BE PREPAID

THE lucky winners of 2 free movie passes, HomeTown Newspapers and the MJR Theatres.

FURNITURE Brown leather sofa, good cond \$400 Coffee, end table, mission style, \$50 both. 248-446-9989

ALL ADS APPEARING UNDER THIS CLASSIFICATION MUST BE PREPAID

HOWELL My digital moving sale. Furniture, electronics, office equip., desk, couches, tables, chairs. (517) 546-9019 www.L2P.com/sale

MINICOTE SOFT water system, \$2,500 Panasonic massage lounger, \$1,000 Oak entertainment center, fits 36in TV, \$225 Weatherproof tool shed, \$225 (517)552-8782

ALL ADS APPEARING UNDER THIS CLASSIFICATION MUST BE PREPAID

SOFA, LOVE SEAT. Elegant camelback design Exc cond \$500/best offer 248-264-6002

SOFA-THOMASVILLE- 3 piece sectional, Blue/Cream, exc cond \$450. (810) 229-7525.

ALL ADS APPEARING UNDER THIS CLASSIFICATION MUST BE PREPAID

SOLID OAK china cabinet & matching table & chairs. Very elegant, flawless. Antique solid fringe. Amara side-by-side fridge w/water & ice dispenser, 2 yrs old 810-629-1936

Southwest Entertainment White Entertainment Center, Coffee Table, 2 End Tables, lamp & coasters \$400 Tel. 248-437-7055

ALL ADS APPEARING UNDER THIS CLASSIFICATION MUST BE PREPAID

TEMPERED STYLE memory foam Queen Mattress Set. New, still in plastic. \$650 810-225-1282

Toddler bed Glider w/ottoman. New Emerson 1000watt micro, (248)921-5780

ALL ADS APPEARING UNDER THIS CLASSIFICATION MUST BE PREPAID

TRUNDLE BED light wood \$100. Bangout table \$25. Call (248) 349-3310

Save a Life, Sponsor A Pet For only \$25 you can help! Are you an animal lover? Here's a great way to express it. Sponsor a pet photo on our special "Save a Life" page publishing on Thursday, December 30th, 2004. Your sponsorship will secure a space for a photo of a pet who is available for adoption and needs a good home. This special page can save hundreds of lives all over the county, thanks to people like you! Be a part of saving a life and feel great about doing it. This page is presented in conjunction with our local animal shelters. Save a Life Sponsor Form HomeTown Name: Address: City: State: Zip: CC#: Exp: Signature: Phone (required): For check, make payable to "HomeTown Newspapers". Sponsor info to appear in space below photo, 20 characters or less. Sponsored by Mail this form with your check or credit card information to: Save a Life c/o Green Sheet Classified, P.O. Box 2309, Howell, MI 48844 FAX: 248-437-9460 CALL: 517-548-7392

CROSSWORD PUZZLE ROSE GARDEN ACROSS 1 "It's the truth" 5 Restrain 10 Conduit fittings 14 Active volcano 18 "The Green ..." (56 hr) 19 Victorian ornament 20 Rache's sister 21 TV's "The Wonder ..." 23 Guse n' 26 - nous 27 Soprano Gluck 28 "A day's work" 29 South Nancy 31 Herman's "Krazy ..." 32 Mythical monster 34 In flight 37 Adjective suffix 38 One of "The Three Tenors" 43 Rock's - & the Gang 44 Pine 46 Krmno cum-burnd 47 Interrogates 49 Cranny's companion 51 Toomey or Phibin 54 Rose Nyland's portrayal 58 Okefenokee, for one 61 Skin problem 62 Irwin of "The Crocodile Hunter" 63 78 Peace Nobelist 65 Pestiferous person 67 Unmatched 68 Went like 71 Apprehend 72 Cum in or conardier 121 Perry of peseta 122 Wrong architect 126 Saarinne 129 Conductor Seij 131 Rose McGowan movie 136 Murcia master 137 Take - the chin 138 Spring for 139 Address Ward 140 Live on lettuce 141 Bean on the bean 142 Hope's "The Prisoner of ..." 143 North Carolina campus 98 "The Name of the Rose" author 101 Send the money 103 Salt serving 105 - Alto, CA 106 Dover's st. 107 Fight site 110 Temporary wealth? 112 Butcher's offering 115 "The - and I" ("47 film) 117 "Fak ..." 119 Ending for "huncher" 120 Sought office 121 Perry of peseta 122 Wrong architect 126 Saarinne 129 Conductor Seij 131 Rose McGowan movie 136 Murcia master 137 Take - the chin 138 Spring for 139 Address Ward 140 Live on lettuce 141 Bean on the bean 142 Hope's "The Prisoner of ..." 143 North Carolina campus DOWN 1 Patches 2 Where the tall corn grows 3 Gallagher of Oasis 4 Aftershock 5 New Deal agcy. 6 "Very funny" 7 Runner Zatopek 8 Room without a view? 9 Alaskan bear 10 Shady character? 11 Wahner's wreath 12 Joe of "Dr Quinn" 13 '62 Four Seasons hit 14 Glasses 15 Dress size 16 "Rambin" Rose singer 17 Stage backdrop 22 Clockmaker Thomas 24 Grocer's measure 25 Tarparker? 30 Vane letters 33 Gulet 35 Perch 36 Run through 38 Male swans 39 Help a hood 40 Formal ceremony 41 - blond 42 Goes downhill fast? 45 Stephen of "Interview with the Vampire" 48 Losses a lap 50 Phi Beta - 52 79 Down's homeland 53 Passover meal 55 Watching machines? 56 Petty officer 57 Dairy-case purchase 59 "Upstairs, Downstairs" extras 60 Ornamental loop 64 Gulf 65 Most revolutionary 69 Druvige 70 - Lama 72 Cocktail 74 R makes candy date 75 Austen bde start 76 "The Rose Tattoo" actress 78 Christened 79 "Elephant Boy" star 85 Wine and dine 88 Moral man? 89 Stows sight 91 A swan was her swan 92 Summer-time treats 93 Lamebrain 95 Russian space station 97 Tranquil 99 Lily of pharmaceuticals 100 Morning wear 102 4 p.m. vehicle? 104 Muslim dietary term 108 Sgt. or cpl 109 Like lemons 111 WWII admon 113 Short a sail 114 Thrust words 115 Desire defied 116 Looked longingly 118 - a customer 123 Concerning 124 Lightweight gun 125 Large berm 127 What today 128 Christiana, today 130 Attention 132 Wolfram - Eschenbach 133 Squid's squirt 134 "Wings" abbr. 135 Solo of "Star Wars"

CHILD CARE DIRECTORY For more information Please call Leslie 517-548-7392 or Fax 248-437-9460 email: lmeredith@ht.homecomm.net

**7800-7980**  
ANIMALS/PETS/LIVESTOCK

**KENMORE GLASSTOP** stove, white, \$175. Built-in white Kenmore dishwasher, \$125. Recliner sofa, \$125. All good cond. 248-676-0525

\*\*\*\*\*  
**PLACE YOUR OWN CLASSIFIED AD ON-LINE.**  
Check out our website, [www.888-999-1288.com](http://www.888-999-1288.com)  
\*\*\*\*\*

**BALDWIN ACROFONIC** piano, \$350. Lowrey home organ \$200. Call 248-374-9452.

**DRUM SET** 5 piece Pearl Export Series w/4 cymbals (Zildjian) Stands, cases, pedals & seat. Exc. cond., \$1100. Brian (248) 470-3063.

**DRUMS** Pearl Export, chrome, 5 piece. Great cymbals w/all stands. Great cond. \$900 Howell (517) 545-9906

**AIR HOCKEY TABLE**, Full size, exc. cond., 1 yr old, \$175. SOLD!!!

**BURTON Feather 154 Sawboard**, 2004 Only used 4 times. Exc. cond. SOLD!!!

**Bestmaster AR-15 Carbine**, comes w/scope & scope mount, ammo., & gun case. \$800/best. SOLD

**COMPETITION SPORTS** dome hockey game w/electronic scoreboard. Like new \$300. (517) 552-1396

**GOLF CLUBS**, Callaway X14 Irons. Brand new, 3 thru pitching wedge, \$330. Also golf odds & ends. 734-878-0725

**MOVING, MUST SELL** 3 piece state pool table, brand new. Worth \$2,000, first \$875. (248)884-3538

**MUST SELL!** Pool table, 8ft., 3 piece state. Paid \$1,800, sell \$300. You haul. 810-629-1233

**SOLOFLEX** with butterfly and leg attachments and all accessories \$400 734-462-2907

**\$ TOP Dollar Paid \$** for coins, gold, diamonds, guns. Uptown Exchange, (810)227-8190.

**BUYING OLD/USED** ★★ Musical Instruments, Guitars, Violins, Trumpets, Saxophones, etc. (517) 525-1601

**LOOKING FOR OLD UNITED STATES** Paper Money, 1929 and Before. For my generous offer write to James Christopher, P.O. Box 16471, Knoxville, TN 37996

**SCRAP METAL** Highest Prices Paid Copper 0.70¢-1.05 per lb. Brass 0.25¢-0.45¢ per lb. Alum., 0.25¢-0.45¢ per lb. Stainless 0.20¢-0.30¢ per lb (248) 968-1200 Mann Metals Corp 1123 Decker Rd., Walled Lk.

**7140**

**AKC LAB.** pups, 5 black, 1 yellow, vet checked, 1st shots, dew claws removed, ready 12/10. \$350. 517-851-0048

**AKC POMERANIANS** Females, \$500 each. (517) 548-5567

**AKC YORKSHIRE PUPPIES** 1 male, 1 female, 11 weeks, 2nd shots & wormed (517) 223-7620

**CHRISTMAS PUPPIES** Peekashu's, Shih-Tzu, Blue Heelers, Jack Russells, AKC Boxers. 1st shots, wormed, \$200 & up. (517)861-7297

**ENGLISH SPRINGER PUPS** AKC, Black/White, Liver/White, excellent family pet or hunt. 6 wks (517) 548-6409.

**GERMAN SHEPHERD PUPS** AKC, blacks, white, black & tans. Some older rescues, \$150. (517) 223-7385

**GERMAN SHORTHAIR POINTER PUPPIES** AKC registered, 8wks old, hunting & companion, \$450 248-486-4532 734-323-9579

**GREAT DANE PUPPIES** AKC Reg Black \$400 each, male & female. (248)388-8714

**LAB PUPS - AKC** Champion blood line, shots, dewes. \$350 Call Chris at (734) 216-7161

**LAB PUPS, AKC.** Adorable, yellow, blacks & chocolates. Vet checked. \$250-\$400 Howell (517)548-0811

**LHASA APSO Pups** Registered, Shots & wormed Call 517-545-3117

**MALE ROTTWEILER**, 1 yr., shots, neutered, housebroken. Must go to good home. Cell phone, (517)404-3868

**MILITARY Aussies** Reg. healthy, colors, 989-756-2446 or 248-634-4954.

\*\*\*\*\*  
**PLACE YOUR OWN CLASSIFIED AD ON-LINE.**  
Check out our website, [www.888-999-1288.com](http://www.888-999-1288.com)  
\*\*\*\*\*

**Presa Canario Pups** 8 weeks old, \$900 00 & up 313-585-4078 renegaderarebreeds.com

**PUG PUPS, CKC, 10wks.** wormed, 1st shots, w/papers. \$600. 248-486-3446

**ROTTWEILER PUPS** READY FOR CHRISTMAS \$350. Call (810) 632-7365

**Rottweiler, 2yr old male,** fixed, indoor, loving dog is good w/kids. \$100 Tel: 248-680-8352

**SHELTIE PUPS - Females,** 9 wks, sable/white, genetic testing, champion bloodlines \$600 (810) 231-9053

**SHIH TZU, ADORABLE,** AKC, 8 wks., vet checked, ready to go, males, tri-color 517-548-5093, 989-362-5398

**SHIH-TZU PUPPIES** 1st shots, adorable, \$325 Call 248-437-1105, leave message.

**SHIH-TZUS:** Puppies, Also, 2 males, 1 yr. & 3 yr old In time for X-mas 248-349-2313

**7140**

**YORKIE MIX,** boy male, \$450 Vet checked, shots, ready for Christmas! 248-437-5725

**YORKSHIRE PUPPIES** Shots, wormed, vet checked (248) 437-8805

**YORKSHIRE TERRIERS** Beautiful Puppies Loving homes only Call Lisa 248-486-1037

**Farm Animals/Livestock** (7150)

**SHEEP,** healthy, gentle, Columbia White Face Need to sell flock of 10 immediately due to my injury Asking only \$900. (517) 546-9812

**ARAB MARE** in foal to AQHA stallion, asking \$1200. Call 248-486-1517

**QUARTER HORSE, MARE** 6 yrs., top safe Lease, trade or sell. (248)634-4954

**SOUTH LYON HORSE BARN** FOR RENT (1) 7 stall, (1) 27 stall, InvOut arenas, heated observator. Grooming/tack stalls. (248) 437-2638

**THOROUGHBREDS** 4yrs-10yrs 15H-15.5H. 1982 Cattle Ack goose neck trader, good tures. \$1750/best. 586-295-0706, 517-468-3407

**WANTED: BARN** Assistant and Exercise Rider for private farm. S Lyon area (248)486-1517

**Horse Boarding: Commercial** (7170)

**BOARDING** Daily turnout, stalls cleaned daily, heated indoor arena, heated buckets. Riding lessons avail. Cohoctah 517-223-4162

**HORSE BOARDING** Pasture, \$150/month (517) 294-6555

**PASTURE BOARD** \$125/mo 80 acres to graze, 1000 rindg acres, hay & feed incl. Brighton area (313) 215-5554

**FOUND female white long hair** cat w/gray/tan marks. S Lyon. 11/23 (248) 921-5780

**FOUND Cat, black & white.** Union St/ Detroit, Milford 248-685-7499

**Found 10/22 Orange/Golden** Cat wearing collar. Northville Estates. 248-349-2167.

**FOUND CAT.** Black, white paws. 8 Mile & Marshall Rds (248)486-1193

**LOST Doberman, brown &** clipped Green Oak Trp \$150 reward. (248) 486-4947

**LOST CAT** orange male, green eyes, Faussett/Mabley Hill, Fenton. (810)750-1447

**LOST CAT** Bobtail Manx, gray tiger, Huron/River Rd, Milford, needs meds. 248-684-6556

**8000-8990**  
AUTOMOTIVE/VEHICLES

**UNDECIDED WHAT CLASS YOUR AD SHOULD BE IN?**  
Put the ad under 2 different classes for a Terrific Discount

Call the HomeTown Newspapers Greensheet Classified Dept. for details.

1-888-999-1288  
\*Some restrictions may apply.  
\*Mention ad to receive discount.

**Boats/Motors** (8020)

**CENTURION** 1987 speed boat, w/trailer, no motor \$100 You move (810)629-1233

**Motocycles/Motorcycles/Go-Karts** (8070)

**HARLEY 2000** 883 HUGGER SPORTSTER 3,000 miles, like new. \$5,250 (517) 545-9175

**YOUTH GO KART,** Turbo Turtle Brand New, rode once. Exc. cond. \$350 Call after 6 pm, 517-294-0774

**Snowmobiles** (8100)

**98 ZR600 EFI LE** last \$2399, 98 ZR600 carb great cond. \$2099, 09 ZL500 EFI 1400 ml. lots of extras \$2799 Tel: 810-632-7985

**ARTIC CAT 2000 ZL600** 2,700 mt. w/ 2 place trailer. Excellent cond. \$3500 810-750-3409 after 6pm

**FOUR PLACE** snowmobile trailer, \$450 (810) 229-9037

**POLARIS '96,** 600, triple, low miles, good cond, \$1,400/best. (517) 861-7915

**POLARIS SNOWMOBILE** 1998 Indy Trail 440, \$1400; 2 Guns 410 & 20 ga. shotguns, best offers. 810-459-3557

**SKI-DOO - 2003** Legion Sport 500, 290 miles, like new \$3,600. Renegade 600 HO, 760 miles, exc. cond. \$4,500 both have electric start, reverse & gauges. SOLD

**SNOWMOBILE TRAILER** 2 place, covered aluminum, good cond. \$975/best. (517) 404-1504

**YAMAHA 1995 V-MAX 600 LE,** 1288K w/triton aluminum trailer, both mint, adult owned \$3,800 Call (810) 227-5172

**8120**

**1980-1997 Class C MOTOR HOMES WANTED.** Call Dale. (517)230-8865.

**CARDINAL 2003 312** Bank Hesse Smooth sides, slide out, mint cond. \$22,500/best. Chevy 2004 Silverado Crew Cab Duramax diesel, many extras, low miles, \$35,900/best. (517) 861-0460

**CLASS C MOTORHOME** 1983 24', 83K, all appliances work incl. roof air, no generator, new tires. \$3,750. 517-545-9175

**TROPICAL MH,** 2000, 36 ft., Ford V10, 17K miles, slideout, 2 AC's, 2 TV's, courian counters, 5.5 kw generator, loaded, like new. (810) 229-7142

**WINNEBAGO 1988** Super Chief 31ft., 55K miles, self-contained, sleeps 6, good cond \$11,500. (810)229-8096

**4 POST** above ground host, 7,000 lb. capacity \$500. (517) 548-2068

**BOSS SNOW PLOW** Power V, 8'2" with RT-J, fits GMC & Chevy 1983-2000, complete unit. \$2,300 (517)548-0750

**AAA RATED DONATION** Donate your car, boat or real estate. IRS tax deductible. Free pick-up/low any model/condition. Help Underprivileged children. 1-800-598-9211 Outreachcenter.org

**BRIDGE TOWING & STORAGE** Is paying top \$\$\$ for your junk car, truck, RV & motorcycle. Without title. For info please call 313-779-6254.

**UNWANTED AUTOS** Junk, non running or wrecked, free towing, pay based on cond. (248) 467-0396

**Junk Cars Wanted** (8200)

**UNWANTED AUTOS** Junk, non running or wrecked, free towing, pay based on cond (248) 467-0396

**WRECKED & JUNK CARS WANTED!** (734) 282-1700

**Unity Trailers** (8210)

**TRI-AXLE** 14 ft. flat bed trailer, dove tail w/ ramp, needs work \$200 (734) 878-6629

**8220**

**2001 FORD RANGER** 4 cyl., auto, air only \$6,495 LaFontaine Pre-Owned 248-706-5830

**2002 FORD F-250 LARIAT CC 4x4** Powerstroke Diesel, auto, air only \$26,995 LaFontaine Pre-Owned 248-706-5830

**CHEVY 1990 2500** Ext. cab, 4x4, fairly new motor & trans, ladder rack & tool box, 1 owner. \$1,900. 248-467-0986

**CHEVY S-10, 1996,** V6, auto, air, 90K, exc. cond., \$2,500. (517) 898-1822

**CHEVY S10, 2000, LS** 5 speed, cruise, tilt air, CD, 74K miles, tonneau cover, Sharp! \$6,000. 248-486-4193

**CHEVY WORK VAN, 1991.** Good tres, runs. \$700. (810) 229-2752

**DODGE DAKOTA 1999,** air, CD, full size bed, 69K, \$6000 (734)449-8313

**F-150 1994,** electric windows, remote start, ext. cab, cap on back, \$4,000. (810) 227-5041

**F-150 XL, 1998, V8,** ar/vm radio, bed liner, 128K, great body, runs very good \$6300. Call (810) 225-1655, after 6pm

**FORD 1983 1 ton 12 ft.** stake dump with new parts. \$2000 or best offer. Call after 6 pm, 517-294-0774.

**FORD 1998 Ranger Supercab** 1996, 2 dr., air, cruise, CD, p/w/ps, stereo, 95K, manual trans. \$3,200 (517)546-2923

**FORD 2000 Ranger XLT,** white, super cab, loaded, exc. cond., 79K mi., \$7500. \*\*\*\*\*SOLD\*\*\*\*\*

**FORD F-150 XLT, 1999, 4x4,** super cab, loaded, towing, off road pkg, 123K, \$7000/best. (248)789-4191

**GMC 1988** ext. cab, 1/2 ton, long box V-8, rebuilt trans w/new parts. \$1700/best. 517-294-0774

**GMC 1992, 3/4 ton, SLX** long bed w/ cap, 117K, ar/vm, cassette, cruise, air \$3,295 810-750-1110, 248-997-7611

**GMC 1995 SONOMA** Extended cab, 4 cyl., 5ml, 144K, newer tires, ar/vm cassette, good cond \$1700 (517) 540-0296

**8240**

**GMC 1996** Sonoma SLS, 115K, V6 auto, new parts, runs well, \$4100 or best offer. 810-423-8956, 810-632-9068

**DODGE GRAND CARAVAN ES,** '97, front & rear air, leather quad seating, 125K, \$4,600/best. (810) 229-5778

**FORD WINDSTAR, 2001** air, ps, green, under 60K miles, asking \$8,700 248-349-0290

**CHEVY 1992 Lumina, 77k** ml. on engine, many new parts too numerous to list. \$2200/best. 517-223-7394

**CHRYSLER 1997 TOWN & COUNTRY LXI.** Leather, exc cond., 1 owner, 142K, \$6,800 248-446-4998 after 7pm.

**DODGE 1999 CARAVAN** Auto, air, 75K miles, like new cond. \$4,500 517-545-9175

**HONDA ODESSY 2003** EX loaded w/leather heated seats, rear AC, ar/vm CD, 1 owner \$18,500. (810)229-0088

**HONDA, 2003 ODYSSEY EX.** CD, power sliding doors, 33K, exc cond., sec. system, rear air, \$19,900 (734) 954-9195

**MERCURY VILLAGER 1997.** 100K miles, runs great. Interior tax \$950/best (248)789-4191

**8260**

**MONTANA 2002** Like new inside & out, 7 passenger, leather, all options, new tires & brakes, 75K ext. factory warranty, \$1,000 under Blue Book, gorgeous vehicle, \$13,500. (810) 599-2996

**1992-2000 HANDICAP VANS** WANTED. Call Dale anyday, (517)230-8865.

**1992-2000 HANDICAP VANS** WANTED. Call Dale anyday, (517)230-8865.

**1992-2000 HANDICAP VANS** WANTED. Call Dale anyday, (517)230-8865.

**1992-2000 HANDICAP VANS** WANTED. Call Dale anyday, (517)230-8865.

**1992-2000 HANDICAP VANS** WANTED. Call Dale anyday, (517)230-8865.

**1992-2000 HANDICAP VANS** WANTED. Call Dale anyday, (517)230-8865.

**1992-2000 HANDICAP VANS** WANTED. Call Dale anyday, (517)230-8865.

**1992-2000 HANDICAP VANS** WANTED. Call Dale anyday, (517)230-8865.

**1992-2000 HANDICAP VANS** WANTED. Call Dale anyday, (517)230-8865.

**1992-2000 HANDICAP VANS** WANTED. Call Dale anyday, (517)230-8865.

**1992-2000 HANDICAP VANS** WANTED. Call Dale anyday, (517)230-8865.

**1992-2000 HANDICAP VANS** WANTED. Call Dale anyday, (517)230-8865.

**1992-2000 HANDICAP VANS** WANTED. Call Dale anyday, (517)230-8865.

**1992-2000 HANDICAP VANS** WANTED. Call Dale anyday, (517)230-8865.

**1992-2000 HANDICAP VANS** WANTED. Call Dale anyday, (517)230-8865.

**1992-2000 HANDICAP VANS** WANTED. Call Dale anyday, (517)230-8865.

**1992-2000 HANDICAP VANS** WANTED. Call Dale anyday, (517)230-8865.

**1992-2000 HANDICAP VANS** WANTED. Call Dale anyday, (517)230-8865.

**1992-2000 HANDICAP VANS** WANTED. Call Dale anyday, (517)230-8865.

**1992-2000 HANDICAP VANS** WANTED. Call Dale anyday, (517)230-8865.

**1992-2000 HANDICAP VANS** WANTED. Call Dale anyday, (517)230-8865.

**1992-2000 HANDICAP VANS** WANTED. Call Dale anyday, (517)230-8865.

**1992-2000 HANDICAP VANS** WANTED. Call Dale anyday, (517)230-8865.

**1992-2000 HANDICAP VANS** WANTED. Call Dale anyday, (517)230-8865.

**1992-2000 HANDICAP VANS** WANTED. Call Dale anyday, (517)230-8865.

**1992-20**



<p><b>7160</b></p> <p><b>UNDECIDED WHAT CLASS YOUR AD SHOULD BE IN?</b></p> <p>Put the ad under 2 different classes for a <b>Terrific Discount</b></p> <p>Call the Hometown Newspapers GreenSheet Classified Dept. for details.</p> <p>1-888-999-1288 *Some restrictions may apply *Must mention ad to receive discount.</p>	<p><b>7200</b></p> <p><b>Barbara Buys</b></p> <p>If you're selling an item for \$100 or less</p> <p>Call 888-999-1288 today! *Some restrictions may apply</p>	<p><b>7220</b></p> <p><b>WINDOW OVERSTOCK SALE</b></p> <p>Cash &amp; carry No warranties, no delivery Michigan Window &amp; Door, Whitmore Lake, Sat. 12/4 &amp; Sat. 12/11, 8am to 2pm. (734)449-9150</p>	<p><b>7440</b></p> <p><b>FINISHED Merchandise</b></p> <p><b>DRY SEASONED HARDWOOD</b> Mostly Oak Call Ron the Firewood Guy 248-676-8529 for delivery &amp; stacking</p> <p><b>MILFORD HIGH</b> school student selling seasoned face-cords, 16'x8'x4", \$60 delivered &amp; stacked. 248-685-3661</p> <p><b>Mixed, Seasoned hardwood</b> Delivery only. \$70 Call (248) 437-5541</p>	<p><b>7480</b></p> <p><b>Lawn, Garden &amp; Snow Equipment</b></p> <p><b>JOHN DEERE GT 235</b>, 48" mowing deck, 48" snowblade, + weights &amp; chains, new garden cart, lawn roller, aerator spreader New in April - Must sell. \$4,500. 810-919-2042</p> <p><b>TROY BILT 1998</b>, 20 hp riding tractor, 48 in. deck, 54 in. snow blade, 2 stage snowblower, \$3500. (810)599-8153</p>	<p><b>7150</b></p> <p><b>Auto Misc.</b></p> <p><b>2005 CIVIC V.P. 4 DR AUTO</b></p> <p>Front disc brakes, wish bone suspension, variable assist rack &amp; pinion power steering, immobilizer theft deterrent system, AM/FM stereo w/4 speakers &amp; in dash CD player, A/C, rear defrost &amp; more. ES1635W</p> <p><del>\$169.00</del> <del>\$157.00</del> <del>\$157.00</del></p> <p>was \$15,575 <b>NOW \$13,315*</b></p> <p>2.9% APR Available</p>	<p><b>7495</b></p> <p><b>Tree Sales</b></p> <p><b>PINES, SPRUCES</b> Large selection, 4-40ft. tall Delivery + installation available (248)349-5480</p>	<p><b>7150</b></p> <p><b>Auto Misc.</b></p> <p><b>2005 CIVIC LX 4 DR AUTO</b></p> <p>AM/FM stereo w/in-dash player, power windows, locks, mirrors, cruise, tilt, keyless entry &amp; more. ES1655PW</p> <p>was \$16,825 <b>NOW \$14,909*</b></p> <p>2.9% APR Available</p>	<p><b>7150</b></p> <p><b>Auto Misc.</b></p> <p><b>2005 ACCORD LX 4 DR AUTO</b></p> <p>Power windows, mirrors, locks, cruise, tilt, A/C, dual front air bags, side air bags &amp; side curtain air bags, ABS brakes, keyless entry &amp; much more. CM5645EW</p> <p><del>\$254.00</del> <del>\$242.00</del> <del>\$242.00</del></p> <p>was \$20,990 <b>NOW \$18,449*</b></p> <p>1.9% APR Available</p>
<p><b>7180</b></p> <p><b>Appliances</b></p> <p><b>GAS DRYER</b>. Works great. Good cond. \$50. firm. Call Stan at 248-860-3723</p> <p><b>GE</b> white side-by-side fridge, w/water, ice &amp; night light on door, 6 yrs. old, works exc. \$200.</p> <p><b>GE</b> GAS dryer, Kenmore washer, large capacity, 7 yrs. old, exc. cond. \$150 248-264-6002</p> <p><b>Kenmore Heavy Duty Gas Dryer</b>, beige, Exc Cond \$100 Tel: 248-684-7761</p> <p><b>STOVE</b> - GE, self cleaning, exc. cond. \$175. <b>DISHWASHER</b> - GE, pot scrubber, exc. cond. \$175. (810) 229-9443</p>	<p><b>7210</b></p> <p><b>Bicycles</b></p> <p><b>BRAND NEW</b> 5 speed Schwinn Tim Horton's anniversary edition, \$350. (248) 685-9071</p>	<p><b>7310</b></p> <p><b>Commercial/Industrial Machinery For Sale</b></p> <p><b>DIESEL GENERATOR</b>, 5500w, 8hp; Gas Generator, 3000w, 5 5hp; Compressor. Demo equip. 50% off. 248-982-1361</p>	<p><b>7380</b></p> <p><b>Farm Equipment</b></p> <p><b>FORD 8N TRACTOR</b> w/6 ft. rear blade, exc., \$2850. Also, avail. 6 ft. mower, spare turf tires on rims, rear tire chains. (734) 878-5859</p> <p><b>UTILITY TRACTOR</b> 43 hp, diesel, 4wd, \$5,700 (810) 231-3354</p>	<p><b>7460</b></p> <p><b>Hospital/Medical Equipment</b></p> <p><b>MINI-MED 507C PUMP</b> (Used) &amp; brand new supplies (734) 878-5762</p> <p><b>WHEELCHAIR, WALKERS</b>, one w/3 wheels, scooter, hydraulic bed. Like new, make offer. (248) 437-1548</p>	<p><b>7500</b></p> <p><b>Miscellaneous For Sale</b></p> <p><b>THE SLOAN FARM LATE FALL SPECIAL</b> Trees on sale for Fall planting: Norway Spruce, 5'-7', \$50; Sugar &amp; Red Maples, 1 1/2"-2" cal. \$50; Call Andrew, 517-546-3094 for current hrs</p>	<p><b>7480</b></p> <p><b>Lawn, Garden &amp; Snow Equipment</b></p> <p><b>FREE 4-ROOM DIRECT TV SYSTEM</b>. Includes standard installation. 3 Months Free HBO &amp; Cinemax! Access to over 225 channels! Limited time offer. S &amp; H Restrictions Apply 1-800-474-4959</p>	<p><b>7220</b></p> <p><b>Building Materials</b></p> <p><b>LP FURNACE</b> used, \$200. New 6 ft. doorwall \$100 &amp; fireplace, crated, \$150. 248-685-7579</p>	<p><b>7480</b></p> <p><b>Lawn, Garden &amp; Snow Equipment</b></p> <p><b>ALL ADS APPEARING UNDER THIS CLASSIFICATION MUST BE PREPAID</b></p>
<p><b>7200</b></p> <p><b>Barbara Buys</b></p> <p><b>AIRDOME</b> exercise bike, \$100. Weight set, stand &amp; bench, \$100. Brand new telescope, was \$350, now \$150. Brand new 2 man jacuzzi, \$995. (810) 231-9687</p>	<p><b>7220</b></p> <p><b>Building Materials</b></p> <p><b>Natural Granite Countertops</b>. Warehouse clearance. Beautiful prefabricated Natural Granite 25' X 8' with 1 1/2" full bullnose edges, \$410 each. 36" X 74" island tops with bullnose edges, \$510 each. Many colors. We take Visa/MC. (248) 486-5444</p>	<p><b>7415</b></p> <p><b>Hay, Grain, Seed</b></p> <p><b>BEAUTIFUL TIMOTHY HAY</b> 1st &amp; 2nd cuttings. Square bales 50-55lb. \$4.75 1st cutting, \$5.25 for 2nd. Delivery avail w/200 bale minimum. 248-735-0081 leave message.</p>	<p><b>7470</b></p> <p><b>Jewelry</b></p> <p><b>DIAMOND SOLITAIRE ENGAGEMENT RING</b> .59 ct. 1414 gwt. Asking \$1,800. 517-404-6073</p>	<p><b>7480</b></p> <p><b>Lawn, Garden &amp; Snow Equipment</b></p> <p><b>DEICING SALT</b>. 80 lb. bag, \$3.90. 50 lb. bag, \$2.80. Pick up only. (248)437-9136</p>	<p><b>7480</b></p> <p><b>Lawn, Garden &amp; Snow Equipment</b></p> <p><b>EASY RAKE YARD VAC</b> pull behind garden tractor, 5hp vac w/cutter, 35 cu ft. capacity, misc. adapters &amp; hose, manuals, good cond. \$450/best offer. 248-685-2103</p>	<p><b>7480</b></p> <p><b>Lawn, Garden &amp; Snow Equipment</b></p> <p><b>EX-MARK 52"</b> walk behind commercial mower, with carriage, great cond., \$800. (810) 266-5091</p>	<p><b>7420</b></p> <p><b>Christmas Trees</b></p> <p><b>CHOOSE &amp; CUT CHRISTMAS TREES</b> www.herbaldtrees.com, S. of Fenton. Open Fri, Sat, Sun, starting Nov 26. 810-629-6251</p>	<p><b>7480</b></p> <p><b>Lawn, Garden &amp; Snow Equipment</b></p> <p><b>INGERSOLL 3012</b> tractor, hydro 44in. cutting deck, 48in. snowblower, tire chains, exc. cond. \$1,700. (248)437-6655</p>

# Christmas Tree Directory

**Harley Keeling Christmas Tree Farm**

**\$25**

Blue Spruce U-CUT All Size Trees

1 Mile East of Latson Road South side on Curdy Road, Northeast of Howell

Open Dec. 4, 5, 11, & 12, Sat. & Sun.

11 am - 4:30 pm

(517) 546-5666 (517) 548-2137

**Broadview Christmas Tree Farm**

\$2.00 off w/this ad

\$50 for Scotch Pine, \$40 for Spruce \$60 for Douglas Fir

Other sizes specifically priced. Pre-cut Trees, Roping & Wreaths Also Available

Beginning Nov. 20

Open 7 Days a Week 9-5

4380 Hickory Ridge Road., Highland

3 Miles North of M-59

(248) 887-TREE or (248) 887-4865

www.broadviewtreefarm.com

**SKYHORSE STATION TREE FARM**

Farm Fresh 6' to 12' Christmas Trees

Make it a special Christmas

Take a drive in the country

- Cut - Your - Own -

Fraser Fir • Douglas Fir • Canadian Fir • Scotch Pine

Hot Food & Beverages • Wagon Rides • Bonfire (Saws Provided)

Open 9-5 Weekends Dec. 4th, 5th, 11th & 12th Only

11000 Roberts Road, Stockbridge

For Directions

Call Toll Free 1-800-497-2682

or visit our website:

www.skyhorsestation.com

**Earls Farm & Produce**

3958 Milford Rd. Milford, MI 48138

(248) 685-0058

- White Pine
- Concolor
- Douglas Firs
- Fraser Firs
- Noble Firs
- Balsam
- Roping
- Wreaths
- Grave Blankets

**Christmas Trees**

Many Varieties of Spruce, Pine & Fir

Live Balled Trees • Wreaths

Homemade Donuts, Coffee, Cocoa, Ode, Gift Shop in our warm barn

Open Sat. & Sun. 9am to dark

Large trees available

**Waldock Tree Farm**

3090 Dutcher Rd. - Howell

Take D-19 (at I-96 exit 137) South to Coon Lake Rd. West to Dutcher Rd., follow signs.

Choose N-Cut

(517) 546-3890

**NORTHVILLE TREE FARM**

Cut Your Own Tree!

Scotch-Austrian-White Pine 4' to 14'

Landscape Trees Available

Come out & tag your tree early to ensure you get the perfect Christmas Tree. Receive a FREE Tree Stand\* when you tag early. \*Quantities Limited - hurry in!

**BRING YOUR CAMERA!**

All Trees Start At \$20

**A FUN FAMILY EVENT!**

We're Easy To Find or Call!

9236 Hickory Ridge, Northville

5 Miles West of Northville, off 7 Mile Road

(909) 909-7808

**Living Christmas Trees**

Can be planted after Christmas

Also Fresh Cut

Blue Spruce • Douglas • Concolor • Fraser Fir

\*Cut Your Own\* Scotch Pine, Douglas Fir (limited supply), Ball Spruce and Fir to 20 Ft.

Roping & Wreaths, Wagon Rides on Weekends!

**HUFF TREE FARM**

1500 W. Wardlow Rd., Highland

1 mi N of M-59 & 1 mi. W. of Milford Rd.

OPEN Everyday 10 am to 5 pm

(248) 887-4230

**Cowbell Lawn & Garden**

850 N. Old U.S. 23

Brighton, MI 48114

(810) 632-5841

M-F 9-5, Sat. 9-4, Sun. 10-4

Scotch Pine, Fraser, Douglas & Canadian Firs

6' to 9' Available (9' in Douglas Fir only)

All trees \$39.99 or less!

50' Cedar Roping, Wreaths & Poinsettias available

**L & L Landscape**

(248) 318-8356

Open 7 Days 9 to 9

FRESH CUT:

- Scotch Pine • Blue Spruce • Douglas Fir
- Fraser Fir • Balsam Fir • Black Hill Spruce
- Australian Concolor Fir

From 6' to 14'

2 Locations

- HARTLAND Corner of 23/59
- WATERFORD Front of Lakeland Ice Arena

**Howell Nature Center**

1005 Triangle Lake Rd.

1 Mile West of D-19/5 miles South of Howell

HUGE SELECTION OF MANY VARIETIES OF FRESH CUT FIR SPRUCE & PINE

CUT YOUR OWN SCOTCH PINE

Tree Shaking & Wrapping

Tour Live Wildlife exhibits on weekends, Hayrides, wreaths, roping, refreshments

Open Daily 9am - 5pm Starting Nov 26th

(517) 546-0249

SANTA VISITS ON WEEKENDS

Breakfast with Santa! Dec. 4 & 5, 11 & 12 (9am & 11am seatings)

Hayrides with Santa Dec 3 & 4, 10 & 11

Reservations Required

To advertise please call Sherry at (517) 548-7375 or fax (248) 437-9460

email: srains@ht.homecomm.net

# Quick Cash

Let the Green Sheet classifieds help you swing a deal.

www.hometownlife.com  
1-888-999-1288

Hometown Green Sheet CLASSIFIEDS



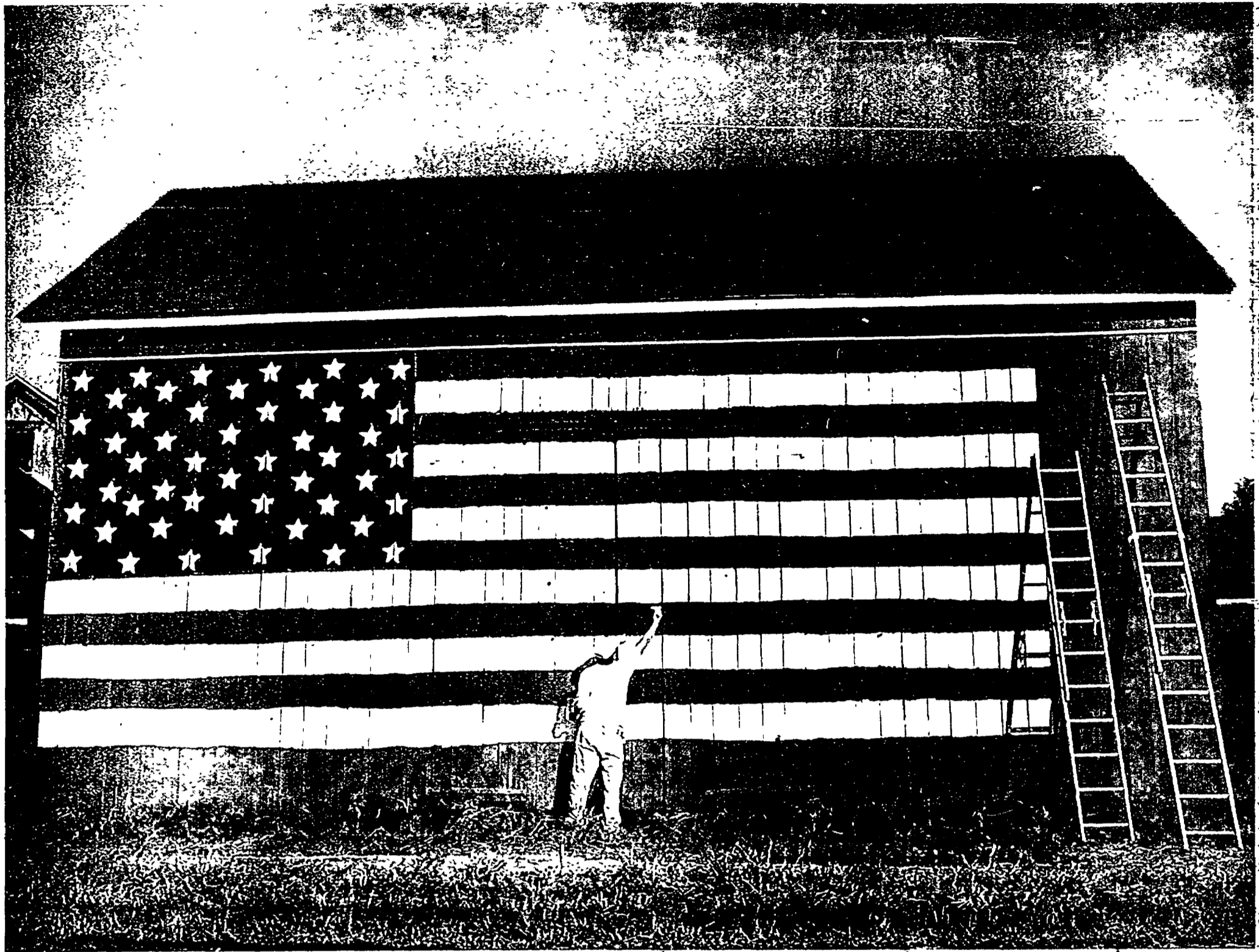

FOR TOO LONG OUR CULTURE HAS SAID, 'IF IT FEELS GOOD, DO IT.' NOW, WE WANT TO BE A NATION THAT SERVES GOALS LARGER THAN SELF. WE HAVE BEEN OFFERED A UNIQUE OPPORTUNITY. WE MUST NOT LET THIS MOMENT PASS. MY CALL IS FOR EVERY AMERICAN TO COMMIT TO THE SERVICE OF YOUR NEIGHBORS AND YOUR NATION. BY DOING THIS, WE SUSTAIN AND EXTEND THE BEST THAT HAS EMERGED IN AMERICA."

★ ★ ★ EVERYONE CAN DO SOMETHING. ★ ★ ★

Answer the President's Call to Service. When you volunteer to help your neighbors, you help your nation. Everyone can do something. To learn more, visit [USAFREEDOMCORPS.GOV](http://USAFREEDOMCORPS.GOV) or call 1-877-USACORPS.





**2002 FORD E-150 CARGO VAN**  
V8, auto, air only \$11,495  
LaFontaine Pre-Owned  
248-706-5830

**GMC 1995 3/4 TON VAN**  
High miles, but runs great.  
\$800 (517) 294-2527

**GMC 1999 SAVANNA** Full size van, loaded, 65K miles, air, auto, \$6,500 517-545-9175

**4 Wheel Drive**

**4 WHEEL DRIVE GRAND VITARA XL7 2001** Suzuki, 4 wheel drive, 7 pass seating, full pwr, SUV. Half the price of Ford or Chevy. You must compare. I've got 2 from \$10995 Tel: 810/772-1533

**CHEVY 1500, 1992, 4WD,** runs good, v6, \$3,500/best (517) 404-5760

**CHEVY 1994 PICK UP** Loaded, transmission slipping, nice body, high miles \$1,600 (517) 548-4830

**CHEVY SILVERADO LT, 2002,** Ext. cab, leather, running boards, tonneau cover, loaded, 15K, \$21,900, (517) 223-8419

**FORD 1993 F-150 - Regular** cab, V8, auto, good cond., well-maintained \$2,150/best. (810) 227-3924

**Sports Utility**

**CHEVY 2002 BLAZER LS 4x4,** shiny wright, all power, CD, moonroof, 52K \$10,900, 810-227-3202, 248-761-0384

**CHEVY TRAILER BLAZER EXTENDED 2002 4 Dr.,** air, alum, Auto, pl, cruise, CD, anti-lock brakes, pw, full service history, 1 owner, ps, am-fm stereo, leather. Loaded! 34,000 miles \$18,750 - 248-561-6601

**FORD 2000 Expedition XLT,** very clean, black, 77K mi. \$12,500. Days 517-546-0061 8-5pm Mon-Fri. or Eves. & weekends 517-202-1096

**GMC 1997 SUBURBAN SLT 4WD,** 120K, leather, loaded, \$8,750/best. (734) 449-0557

**JEEP 1995 CHEROKEE SPORT 4x4,** 4 dr., low miles, Chrysler ext. warranty, exc cond., no rust. \$5,995 (810) 231-4189

**JEEP CHEROKEE 2000, Sport,** 75K, 4x4, loaded, exc cond., 4 dr., \$5800 (517) 898-1822

**Sports & Imported**

**SAAB 900S CONVERTIBLE 1997 2 Dr.,** 1 owner Black, Tan Interior, exc. cond., professional maintenance, loaded, 5 speed manual, 6 CD changer, Fun summer & winter! 130k, garage, orig owner. Email photos. \$9,000 - 734-426-5355

**Antique/Class**

**GRAND TORINO, 1973 351c,** 90K miles, runs good, \$2,000/best. (248) 685-8637

**PLYMOUTH 1964 Belvedere 4 dr.,** V8, auto, southern car \$900/best. (248)446-8261

**Small block Chevy 350 cu.in.,** complete running engine from 1969 Camaro \$500 307 cu in small block Chevy complete running engine from 1971 Chevelle \$350, 400 cu.in. GM cast crank shaft \$35 10 Bolt rear axle complete from 1969 Camaro \$50 ea. 517-404-7883

**Acura**

**INTEGRA 1995 VTEC Air,** am/fm cassette, sunroof, ABS, tint, spoiler, \$5,900 (517) 552-9801 after 6pm.

**Mercury**

**2002 MERCURY COUGAR**  
6 cyl., auto, air low miles only \$12,995  
LaFontaine Pre-Owned  
248-706-5830

**GRAND MARQUIS, 1999** Exc cond., leather interior, new tires/brakes \$4,000 810-599-0291

**Mitsubishi**

**DIAMANTE 2000 LS, 69k mi.** Low miles on Michelin tires Loaded and well maintained \$8500 (517)655-8023 eyes

**DIAMANTE 2003 VR-X, 15k** mi V-6, loaded, security heated seats, remote start \$16,500 (517)655-8023 eyes

**ROADMASTER 1994,** Station wagon, black, full power, \$5000 (248) 349-6636

www.hometownlife.com Thursday, December 2, 2004 GREEN SHEET EAST/CREATIVE LIVING 7D

**OPEN 9-9 MON. Thru THURS. OPEN SAT. 9-4, FRI. 9-7 OPEN SAT. 9-4, FRI. 9-7**

# BRIGHTON

## GREAT SAVINGS ON 2005 MODELS STOP IN TODAY!

**OPEN 9-9 MON. Thru THURS. OPEN SAT. 9-4, FRI. 9-7**

**2005 FOCUS ZX4 4 DOOR**  
REBATES UP TO \$3000  
Was: \$17,690 Stk #50741

A PLAN BUY \$13,997*	X PLAN BUY GENERAL PUBLIC \$14,787*
A PLAN LEASE \$194* 24 MOS. w/\$2000 DUE	X PLAN LEASE GENERAL PUBLIC \$229* 24 MOS. w/\$2000 DUE

**2005 TAURUS SE SEDAN**  
REBATES UP TO \$5000  
Was: \$22,480 Stk #50320

A PLAN BUY \$15,274*	X PLAN BUY GENERAL PUBLIC \$16,195*
A PLAN LEASE \$110* 24 MOS. w/\$2000 DUE	X PLAN LEASE GENERAL PUBLIC \$150* 24 MOS. w/\$2000 DUE

**2005 ESCAPE XLS FWD 4 DR**  
REBATES UP TO \$3250  
Was: \$22,745 Stk #50368

A PLAN BUY \$17,160*	X PLAN BUY GENERAL PUBLIC \$18,126*
A PLAN LEASE \$187* 24 MOS. w/\$2000 DUE	X PLAN LEASE GENERAL PUBLIC \$231* 24 MOS. w/\$2000 DUE

**2005 SABLE LS SEDAN**  
REBATES UP TO \$4500  
Was: \$26,515 Stk #50205

A PLAN BUY \$18,171*	X PLAN BUY GENERAL PUBLIC \$19,208*
A PLAN LEASE \$136* 24 MOS. w/\$2000 DUE	X PLAN LEASE GENERAL PUBLIC \$182* 24 MOS. w/\$2000 DUE

**2004 MUSTANG GT PREMIUM CPE**  
REBATES UP TO \$3250  
Was: \$26,595 Stk #50079

A PLAN BUY \$19,302*	X PLAN BUY GENERAL PUBLIC \$20,394*
----------------------	-------------------------------------

**2005 FREESTAR SE VAN**  
REBATES UP TO \$4750  
Was: \$27,870 Stk #50706

A PLAN BUY \$20,195*	X PLAN BUY GENERAL PUBLIC \$21,323*
A PLAN LEASE \$204* 24 MOS. w/\$2000 DUE	X PLAN LEASE GENERAL PUBLIC \$253* 24 MOS. w/\$2000 DUE

**2005 GRAND MARQUIS GS SEDAN**  
REBATES UP TO \$4500  
Was: \$26,700 Stk #50704

A PLAN BUY \$19,201*	X PLAN BUY GENERAL PUBLIC \$20,319*
A PLAN LEASE \$249* 24 MOS. w/\$2000 DUE	X PLAN LEASE GENERAL PUBLIC \$299* 24 MOS. w/\$2000 DUE

**2005 500 FWD SEL**  
REBATES UP TO \$750  
Was: \$24,795 Stk #50145

A PLAN BUY \$21,241*	X PLAN BUY GENERAL PUBLIC \$22,270*
A PLAN LEASE \$241* 24 MOS. w/\$2000 DUE	X PLAN LEASE GENERAL PUBLIC \$287* 24 MOS. w/\$2000 DUE

**2005 RANGER 4X4 XLT SUPERCAB**  
REBATES UP TO \$2750  
Was: \$28,185 Stk #50318

A PLAN BUY \$21,180*	X PLAN BUY GENERAL PUBLIC \$22,248*
A PLAN LEASE \$179* 24 MOS. w/\$2000 DUE	X PLAN LEASE GENERAL PUBLIC \$229* 24 MOS. w/\$2000 DUE

**2001 VW JETTA**  
6 cyl., 5-sp., air, leather only \$8,495  
LaFontaine Pre-Owned  
248-706-5830

**2005 MONTEREY CONVENIENCE VAN**  
REBATES UP TO \$5000  
Was: \$29,800 Stk #50492

A PLAN BUY \$21,667*	X PLAN BUY GENERAL PUBLIC \$22,864*
A PLAN LEASE \$224* 24 MOS. w/\$2000 DUE	X PLAN LEASE GENERAL PUBLIC \$276* 24 MOS. w/\$2000 DUE

**2005 F150 4X4 SUPERCAB XLT**  
REBATES UP TO \$2250  
Was: \$32,880 Stk #50490

A PLAN BUY \$25,050*	X PLAN BUY GENERAL PUBLIC \$26,312*
A PLAN LEASE \$140* 24 MOS. w/\$2000 DUE	X PLAN LEASE GENERAL PUBLIC \$196* 24 MOS. w/\$2000 DUE

**2005 EXPLORER XLT 4X4 4 DR**  
REBATES UP TO \$4500  
Was: \$35,265 Stk #50418

A PLAN BUY \$25,870*	X PLAN BUY GENERAL PUBLIC \$27,235*
A PLAN LEASE \$197* 24 MOS. w/\$2000 DUE	X PLAN LEASE GENERAL PUBLIC \$256* 24 MOS. w/\$2000 DUE

**2005 FREESTYLE AWD LTD**  
REBATES UP TO \$1750  
Was: \$32,130 Stk #50781

A PLAN BUY \$27,642*	X PLAN BUY GENERAL PUBLIC \$28,928*
A PLAN LEASE \$249* 24 MOS. w/\$2000 DUE	X PLAN LEASE GENERAL PUBLIC \$305* 24 MOS. w/\$2000 DUE

**2005 F250 4X4 XLT SUPER CAB**  
REBATES UP TO \$1750  
Was: \$35,090 Stk #50326

A PLAN BUY \$28,967*	X PLAN BUY GENERAL PUBLIC \$30,305*
A PLAN LEASE \$383* 24 MOS. w/\$2000 DUE	X PLAN LEASE GENERAL PUBLIC \$445* 24 MOS. w/\$2000 DUE

**2005 MOUNTAINEER AWD 4 DR LUXURY**  
REBATES UP TO \$4750  
Was: \$38,515 Stk #50356

A PLAN BUY \$28,743*	X PLAN BUY GENERAL PUBLIC \$30,213*
A PLAN LEASE \$266* 24 MOS. w/\$2000 DUE	X PLAN LEASE GENERAL PUBLIC \$330* 24 MOS. w/\$2000 DUE

**2005 EXPEDITION XLT 4X4**  
REBATES UP TO \$3500  
Was: \$40,775 Stk #50356

A PLAN BUY \$31,221*	X PLAN BUY GENERAL PUBLIC \$32,750*
A PLAN LEASE \$360* 24 MOS. w/\$2000 DUE	X PLAN LEASE GENERAL PUBLIC \$428* 24 MOS. w/\$2000 DUE

**2002 MERCURY COUGAR**  
6 cyl., auto, air low miles only \$12,995  
LaFontaine Pre-Owned  
248-706-5830

**2005 EXPEDITION XLT 4X4**  
REBATES UP TO \$3500  
Was: \$40,775 Stk #50356

A PLAN BUY \$31,221*	X PLAN BUY GENERAL PUBLIC \$32,750*
A PLAN LEASE \$360* 24 MOS. w/\$2000 DUE	X PLAN LEASE GENERAL PUBLIC \$428* 24 MOS. w/\$2000 DUE

**GRAND MARQUIS, 1999** Exc cond., leather interior, new tires/brakes \$4,000 810-599-0291

**PONTIAC 1990 GRAND PRX** Must sell! \$500/best. For list-ings, 800-495-0660 ext. C758

**PONTIAC 1990 GRAND PRX** Must sell! \$500/best. For list-ings, 800-495-0660 ext. C758

**PONTIAC 1994, Grand Prix,** 2 door, good cond., \$1,950 810-227-1263, 517-376-1075

**PONTIAC BONNEVILLE 1992,** SSE, runs great, good cond., \$1,500/best. (248) 755-0385

**TOYOTA 1991 TERCEL -** Runs good, new tires, 72K, \$1,300/best (810) 225-2950, call after 3pm

**BRIGHTON FORD-MERCURY** Michigan's Largest FORD MERCURY DEALER!

**1-800-836-7697**

Or Buy Online [www.brightonford.com](http://www.brightonford.com)

8240 W. Grand River at I-96

**OPEN 9-9 MON. Thru THURS. OPEN SAT. 9-4, FRI. 9-7 OPEN SAT. 9-4, FRI. 9-7**

**2005 EXPEDITION XLT 4X4**  
REBATES UP TO \$3500  
Was: \$40,775 Stk #50356

A PLAN BUY \$31,221*	X PLAN BUY GENERAL PUBLIC \$32,750*
A PLAN LEASE \$360* 24 MOS. w/\$2000 DUE	X PLAN LEASE GENERAL PUBLIC \$428* 24 MOS. w/\$2000 DUE

**2005 EXPEDITION XLT 4X4**  
REBATES UP TO \$3500  
Was: \$40,775 Stk #50356

A PLAN BUY \$31,221*	X PLAN BUY GENERAL PUBLIC \$32,750*
A PLAN LEASE \$360* 24 MOS. w/\$2000 DUE	X PLAN LEASE GENERAL PUBLIC \$428* 24 MOS. w/\$2000 DUE

Think Again Green Sheet CLASSIFIEDS  
www.hometownlife.com  
**1-888-999-1288**

**Going, Going, Gone.**

MOTORCYCLES. New or used, move them fast with the Green Sheet Classifieds. Reach 77,000 readers on Thursdays and 100,000 readers on Sundays.

**Z PLANNERS SAVE AN ADDITIONAL \$1000**

# DEMME DIFFERENCE

**ASK US ABOUT FLEX-BUY**  
The Latest in Auto Financing

Never Before Offered...

## "A-PLAN" PRICING TO EVERYONE\* ON ALL REMAINING 2004 MODELS FROM STOCK Model Year End Clearance Event

**2004 Mustang Coupe**  
Single wing rear spoiler, power driver's seat, speed control, air conditioning, six CD changer radio with mech, 16" bright alloy wheels, overhead valve V6, five speed manual, P225/55R16 94T BSW all-season, interior upgrade package, pony package.  
STOCK #41815 ■ WAS \$21,025

Save Over \$7000! **No. W \$13,841\***

**2004 Ranger XLT SC 4x4**



AMFM stereo/CD player, rally gauge cluster, 4-wheel ABS brakes, 16" aluminum wheels, fog lamps, air, 4.0L SOHC V6 engine, 5-sp auto O/D trans, P245 OVL all-terrain tires, 4.10 ratio regular axle, 5000 GVWR, P235 all-season spare  
STOCK #40935 ■ WAS \$24,095

Save Over \$9400! **No. W \$14,615<sup>40\*</sup>**

**2004 Crown Victoria LX**



Floor and storage/shelving, 5-pass handling pkg., dual exhaust sys., strg whl w/abs/airbrake ctrl, pwr lth w/brk shp, 17.5 spoke alloy whls, 4.6L OH-C SER V8 eng., elect. auto. O/D trans, P235/55R17 BSW tires, iron ctrl, pwr act. pedal, pwr htd mirrors w/brk shp, trunk-mounted CD chng, mnchrmic ext part.  
STOCK #41821 ■ WAS \$31,135

Save Over \$6400! **No. W \$21,065<sup>40\*</sup>**

**2004 Freestar SEL**



3.5L i600 reg. axle, elec. grp. spd control, aux AC in-zone, pwr driver seat, 2nd/3rd row privy glass, 4.2L OHV EFI eng., 4 spd auto O/D trans., P225/60R16 BSW all season, ASP II driver's, deluxe crossbars, elec AMFM stereo/CD chng, active safety pkg I & II, rev sensing system, power pass seat, leather seats.  
STOCK #40620 ■ WAS \$32,555

Save Over \$400! **No. W \$19,790<sup>40\*</sup>**

**A-Plan 66 Month Flex-Buy**  
**ZERO DOWN 2000 DOWN**  
**\$227<sup>96†</sup> \$194<sup>24†</sup>**  
per mo. per mo.

**2004 Expedition 4x4 XLT Sport**



Fold flat 3rd row seat, aux heater, sport accent, lube stop bar, electric in view mirror, P265/70R17 OLV all-terr, tire pressure mntng sys, 5.4L EFI V8, 4 spd auto O/D trans., 3.73 ratio limited slip axle, rev sensing sys, 17" tow, pwr stereo in-dash 6-CD/Chk, cloth captain's chair/console, 11 seat entrmnt DVD  
STOCK #43973 ■ WAS \$42,655

Save Over \$13,000! **No. W \$29,164<sup>40\*</sup>**

**2004 Thunderbird**



Heated driver & pass seat, air AMFM stereo in-dash 6 disc CD, audiophile sound system, 17" 7 speed chrome cast aluminum, 3.9L DOHC V8, 5-speed automatic, engine oil cooler convertible soft top, supplemental parking lamps, select shift trans, accent package, performance removable top  
STOCK #40620 ■ WAS \$41,625

Save Over \$11,200! **No. W \$30,422<sup>40\*</sup>**

**2004 E-150 Conversion Van**



Preferred eqp. pkg, 734A, RV convrt trm, 5.4L EFI V8, elec. auto O/D trans, 3.55 ratio lrn slip axle, aux heater, RV plus pkg, P235/70R16Z OVL all-terr, swing-out SDFX cargo glass, leather-wrapped steering wheel, 16" bright alloy wheels, fold down, full length brds, SteeStar Conversion, wood sls & much more.  
STOCK #43430 ■ WAS \$39,945

Save Over \$5,000! **No. W \$24,532<sup>40\*</sup>**

**SUV EARLY BIRD LEASE PROGRAM** VISIT JACK DEMMER FORDS AWARD-WINNING BODY SHOP-DECEMBER SPECIALS  
for leases expiring Jan. 1, 2005 through April 30, 2005. See Demmer for Details • Free Loaner • Free Lube & Oil Change • Free Pick-Up & Delivery with repairs over \$500

**aplansheadquarters.com**

**\$500 Extra!**

On your trade-in! With the purchase or lease of a new vehicle. 1995 or newer, less than 100,000 miles. All prior sales excluded. Good through 12/31/04.  
**ONE PER CUSTOMER**

**SALES**  
Mon. & Thurs. 8am-9pm  
Tues. & Wed. Fri. 9am-6pm

**CALL 1-888-284-7470**  
www.demmer.com  
**Ph. 734.721.2600**

**SERVICE**  
Monday through Friday  
7:00 am - 6:00 pm

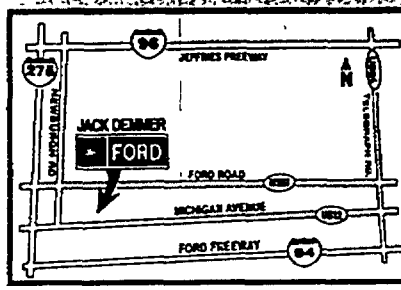

15 MINUTES FROM EVERYWHERE!

# JACK DEMMER FORD! Winter Service Specials

## RECOMMENDED SERVICES



**SCHEDULED MAINTENANCE**  
Service Department Hours  
Monday-Friday 7:00 am to 6:00 pm

Ask about our **SHUTTLE SERVICE** To and From **WESTLAND MALL** To do your Holiday Shopping While your vehicle is in service!



\*Prices do not include sales tax, shop supplies and disposal fees and are subject to change without notice. Prices are based on most cars and light trucks. Heavy duty trucks, vans, diesel engines and some performance vehicles slightly higher. Check with a service advisor for complete pricing.

FASTLUBE OPERATIONS	
Oil & Filter Change & Lube.....	\$23.95
(Up to 5 quarts Motorcraft oil & filter)	
STEERING & SUSPENSION MAINTENANCE +	
Rotate Tires.....	\$19.95
Two Wheel Alignment.....	\$49.95
Four Wheel Alignment.....	\$74.95
BRAKE SYSTEM SERVICES	
Inspect Brakes & Rotate Tires.....	\$34.95
(Includes a visual inspection of brakes)	
Pads / Shoes.....	\$99.95
Motorcraft brake pads per axle (Machine drums or rotors extra)	
Brake Service.....	\$195.00
Includes replace brake pads or shoes per axle inspect and clean all hardware Machine drums or rotors (Motorcraft brake lining used for all menu pricing)	

ADDITIONAL SERVICES	
Filter Package.....	\$67.90
(Engine Air Filter and Fuel Filter for most vehicles)	
Replace Micron Cabin Filter.....	\$54.95
A/C System Check.....	\$59.95
(Includes 12 oz. R134A)	

PREMIUM SERVICES	
Fuel Induction Service.....	\$129.95
Transmission Flush Service.....	\$149.95
Power Steering Flush Service.....	\$89.95
Coolant Flush Service.....	\$99.95
(Diesels Extra)	
Air Conditioning Frigi Fresh Service.....	\$59.95
Differential Service.....	\$99.95
(F150-F250-F350-Expeditions-Excursions Extra)	
Manual Transmission Transfer Case Service.....	\$79.95
(F250-F350 Extra)	

EVERY 5,000 MILES - \$39.95 PLUS TAX	
(Or 3,000 For Severe Conditions)	
• Perform Lube Oil and Filter Service	
• Rotate Tires	
• Check and Fill	
- Window Washer Fluid Level	
- Transmission Fluid Level	
- Brake Fluid Level	
- Power Steering Fluid Level	
- Coolant Recovery Reservoir Fluid Level	
• Check	
- Operation of Horn, Interior Lights, Exterior Lamps, Turn Signals, Hazard and Brake Lamps	
- Windshield Washer Spray, Wiper Operation and Wiper Blades	
- Windshield for Cracks, Chips and Pitting	
- Radiator, Heater, and Air-Conditioning Hoses for Leaks and Damage	
- Engine Air Cleaner Filter	
- Oil and/or Fluid Leaks	
- Constant Velocity (CV) Drive Shafts (If Equipped)	
- Exhaust System (Leaks, Damage, Loose Parts)	
- Drive Shaft, Transmission, U-Joint and Shift Linkage (If Equipped) and Lubricate (As Needed)	
- Steering and Steering Linkages	
- Suspension (Shocks/Struts for Bounce/Leak/Damage)	
• Protection Plan Kit - Extra	
• Diesels - Extra	

30,000* MILE SERVICE - \$312.75 PLUS TAX & DISPOSAL FEE	
60K*, 90K*, 120K*, 150K*	
• Includes All Services Performed at 5,000 Plus the Following	
• Replace Air Filter	
• Cabin Filter (if equipped)	
• Transmission System Flush	
• Check	
- Brake System (Including Lines, Hoses, and Parking Brake) and Wheel End for End-Play and Bearing Noise	
- Engine Cooling System, Hoses and Clamps	
- Accessory Drive Belt(s)	
- Clutch Operation	
- Evaporate Fuel System Hoses and Tubes (Only at 60,000 Mile Intervals Pre-1999 Vehicles)	
• Protection Plan Kit - Extra	
• Replace Fuel Filter	
• Jack Demmer Ford Multi-Point Inspection	
• Diesels - Extra	

15,000 MILES - \$224.85 PLUS TAX	
45K / 75K / 105K / 135K	
• Includes All Services Performed at 5,000 Miles Plus the Following	
• Replace Cabin Filter (if equipped)	
• Fuel Induction Service	
• Check	
- Brake System (Including Lines, Hoses, and Parking Brake) and Wheel End for End-Play and Bearing Noise	
- Engine Cooling System, Hoses and Clamps	
• Protection Plan Kit - Extra	
• Diesels - Extra	

30,000* MILE PREMIUM SERVICE \$632.95 PLUS TAX & DISPOSAL FEE	
60K*, 90K*, 120K*, 150K*	
• Includes All Services in the Standard Service Plus the Following	
• Fuel Induction Services	
• Power Steering Flush	
• Coolant Flush Service	
• Diesels - Extra	

\* Please consult service advisor for recommended premium services.



# Unique

# Gift Ideas

## Christmas Specials

December 1-11, 2004

**15% OFF**  
CANDY-MAKING  
SUPPLIES

INCLUDES: Candy Molds,  
Sucker Sticks, Cello Bags,  
Flavoring Oils, Tags, Colorings & More!!!



Deluxe  
Mixed Nuts  
**\$4.99** lb

Cashews **\$5.49** lb

Date  
Pieces  
**\$1.79** lb

Raw Peanuts  
Great for Peanut Brittle!!!  
**\$1.69** lb

German  
Cinnamon  
Almonds **\$4.99** lb  
These are microwaveable-yummy!  
Save \$1.00 per pound!

Dried  
Cherries  
**\$5.99** lb

**15% OFF**  
ALL SPICES!!  
OVER 70 TO CHOOSE FROM!!!!

WALNUTS  
**\$2.99** lb

SESAME  
STICKS  
**\$1.99** lb

901 E. Grand River  
Howell, MI 48843  
(517) 546-1860

**Incredi-BULK FOODS**  
& In-Store Bakery

HOURS:  
Mon-Wed & Fri 9-7,  
Thurs 9-8, Sat 9-5

**Happy Holidays**

**Pillar to Post** Professional Home Inspection

**\$25 Discount on Home Inspection**  
Offer expires January 15, 2005. Not valid with any other offer.

**Additional \$\$ Savings with Home Inspection**

Radon Testing \$85	Water Quality Test \$75
Termite Inspection \$40	Air Quality Testing \$195 (Includes 2 air samples)

Independently Owned and Operated by Randall Patterson

**JOIN THE NEMO**

**LIMITED SPOTS**  
Only 20 spots... Don't miss!  
Starts Tuesday, January 4th  
@ 4:10pm  
28 Weeks @ \$9.95 per week  
\$15 Registration Fee  
Due at Sign up

**CLUB MEMBERS RECEIVE:**

- 2 Games Competition Each Week
- Free Shoe Rental for Club Day
- Choice of Four Different Balls

517-546-0820  
907 E. Grand River • Howell

**FREE GAME**

Buy One Game at Regular Price, Get One Game FREE!

Coupon valid for up to 5 people.  
Shoe Rental not included.  
Not valid on Fridays after 9pm.  
With Coupon. Expires 2-6-05.

**ROLL IN THE NEW YEAR**

Howell Lanes invites you to our annual New Years Eve Extravaganza!  
Party includes:  
• 3 Games of 9 Pin Fun  
• Complimentary Drink Per Person  
• Happy Hour Drink Prices from 9-10pm  
• Party Favors • Door Prizes • Midnight Buffet  
• Champagne Toast • 2-2 Lash Prizes  
Door Opens at 8:30, Fun Starts at 9:15

60 Candles are one year and one day. Must be 21 or over.

\$100 1st Place Top 5 Teams Win Money!

Here comes Santa Claus, Here comes Santa Claus...  
**Right to RE/MAX All Stars**

You and your family are invited to visit Santa & Mrs. Claus at RE/MAX All Stars located at 401 W. Main Street in downtown Brighton. Santa will be available:

December 4th & 5th Noon - 5 p.m.  
December 11th & 12th Noon - 5 p.m.  
December 18th & 19th Noon - 5 p.m.

Come see the Reindeer every Sunday 1-4 pm & Don't forget your Christmas List! Santa is looking forward to seeing all of you!

**Livingston Lending**  
MORTGAGE COMPANY

120 W. Grand River Ave. • Brighton, MI 48116  
Your Full Service Mortgage Specialist

Thank You for your business and Best Wishes For a Wonderful Holiday Season

- Construction Loans
- ZERO Down Loans
- FHA/VA
- Conventional
- 1st Time Buyer Programs
- Bankruptcy & Credit Repair Specialists

**FREE PRE-APPROVALS**  
**810-229-6669**

**CLOSING COSTS \$250<sup>00</sup> OFF**  
Must Present Coupon At Time Of Application

**merry christmas**  
from Livingston Flight Inc.

We are offering personalized gift certificates starting at \$ 75.00. This is one gift that will not be left on a shelf. Recipient will have a certified flight instructor fly them on a real flying lesson, or just a sight seeing tour.

New Cessna 172 SP's four seaters. Aircraft are kept in a spotless heated hangar. Order by phone, all major credit cards accepted.

fly **LFI.com**  
517-552-1101

Howell, MI Livingston County Airport,  
We are located in the new Cessna hangar by Burkart Rd. where the Survival Flight is - 3800 W Grand River

**Touch of Country Up Town**  
Livingston County's Own Little Frankenmuth

**GIFTS FOR EVERYONE**

Visit our new Holiday location in Downtown at 109 W. Grand River

Ornament Extravaganza Dec. 3-4

Unique Gifts for Gift Exchange  
Greens & Garlands Arrangements  
Christmas Decor  
Secretaries & Friends  
Baby Dept. for Grandmas  
Dept. 56 Villages  
Swarovski & More

Bring your kids for a **FREE** picture with Santa at our M-59 location Sat, Dec. 11th, 11am - 3pm

**Santa Coming on a Fire Truck!**

5640 M-59 Howell  
517-546-5995  
Halfway between Howell & Hartland on M-59

**Touch of Country**

**Holiday Hours**  
Mon-Fri. 10am-8pm, Sat. 10am-6pm

**Brighton Beads & More...**

"Expect the Usual & the Unusual"

Check us out online  
[brightonbeadsandmore.com](http://brightonbeadsandmore.com)

- \* Custom Gifting for you/by you
- \* Classes Metal/Glass/Beading
- \* Gift Certificates

**Drop In Make & Takes Daily**

**810-844-0066**  
9850 E. Grand River - Brighton

Holiday Hours:  
Mon., Wed., Fri. & Sat. 10am-6pm  
Tues. & Thurs. 10am-8pm, Sun. 12pm-4pm

December 4, 6am-Midnight

KOHL'S

# Super Saturday

6am to Noon only

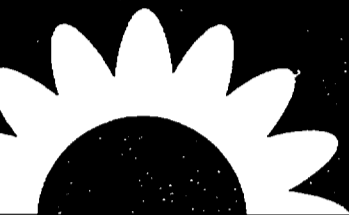

## EARLY BIRD SPECIALS

EARLY BIRD SPECIAL



sale 59.99  
your choice  
2-pc. freshwater pearl necklace and pair of stud earrings set  
pair of 10k gold 1/4 ct. T.W. baguette diamond hoop earrings  
pair of 14k gold 1/4 ct. T.W. princess cut diamond stud earrings  
reg. \$200 & \$225 ea.

shop online F999

70% off entire stock fine jewelry

reg. 29.99-5,000.00, sale 8.99-1,500.00  
Photo enlarged to show detail.  
Diamond Total Weights are approximate. T.W. may vary up to .05 ct. Actual savings may exceed the percent savings shown.



EARLY BIRD SPECIAL

shop online for selected items P1203102

50% off entire stock

Russell® Athletic fleece separates for men & misses and Champion® fleece separates for men  
orig. \$24-\$38, sale \$12-\$19

EARLY BIRD SPECIAL

by Vision Goggles



10-40% off plus save an extra 20% entire stock toys



EARLY BIRD SPECIAL

shop online P1203101

60% off entire stock

leather and suede outerwear for men & women  
Excludes Columbia Sportswear Company  
orig. \$100-\$380, sale 39.99-149.99



EARLY BIRD SPECIAL

10-40% off plus save an extra 15% entire stock kitchen electrics  
shop online for selected items H1600



EARLY BIRD SPECIAL

40% off entire stock watches

reg. 19.95-475.00, sale 11.97-285.00  
shop online for selected items P1203100



Entire stock  
**16<sup>99</sup>**  
Active separates  
for misses  
& petites  
from N.Y.L., Gloria  
Vanderbilt Sport  
& Da' Erika Sport  
misses, shown  
orig. \$30-\$34

**EARLY BIRD SPECIAL**

N.Y.L.

Entire stock  
**15<sup>99</sup>**  
Sonoma denim, twill  
and corduroy pants  
for misses & petites.  
Misses' shown.  
orig. \$34  
shop online P12031

**EARLY BIRD SPECIAL**

Entire stock  
**60% off**  
SO... activewear  
for juniors.  
orig. \$26,  
sale 10.40  
shop online  
P12032

**EARLY BIRD SPECIAL**

SO...so real. so right.™

**18<sup>99</sup>**  
5-pkt. denim jeans  
for juniors.  
Selected styles.  
orig. 29.99

**EARLY BIRD SPECIAL**



# EARLY BIRD

**EARLY BIRD SPECIAL**

SAG HARBOR

**EARLY BIRD SPECIAL**

**EARLY BIRD SPECIAL**

**60% off**  
sportswear  
for misses, petites & women from  
Sag Harbor, Requirements,  
Villager, Norton/McNaughton  
Selected styles. Misses' shown. orig. \$38-\$72, sale 14.40-28.80

**60% off**  
entire stock  
sleepwear & loungewear separates  
for misses, petites & juniors  
Shown in store. orig. \$10-40.00

**60% off**  
entire stock  
ZeroXosur outerwear  
for men and women. orig. \$60-\$140, sale 22.99-\$49.99

Entire stock  
**50% off**  
Phytex,  
Sis  
Cybere  
France,  
Pai  
16  
Zoo  
10

**EARLY BIRD SPECIAL**

Phytex

**EARLY BIRD SPECIAL**

Entire stock  
**50% off**  
Leather handbags  
& handbag  
accessories  
orig. \$8-\$75,  
sale 4.00-37.50

**EARLY BIRD SPECIAL**

Entire stock  
**17<sup>99</sup>**  
Fashion denim  
jeans for girls 7-16  
from Zane-d,  
Jeepie,  
Babagum

**EARLY BIRD SPECIAL**

**EARLY BIRD SPECIAL**

**EARLY BIRD SPECIAL**

Entire stock  
**15% off**  
Fine fragrances  
reg. 5.95-60.00,  
sale 5.05-51.00

ETERNITY

**EARLY BIRD SPECIAL**

**EARLY BIRD SPECIAL**

EARLY BIRD SPECIAL

Entire stock  
**17<sup>99</sup>**  
Khakis and corduroy pants for men from Croft & Barrow, Sonoma orig. \$40



Entire stock  
**40% off**

Cross training and walking shoes for men and women, reg. 44.99-69.99, sale 26.99-41.99  
shop online P12035

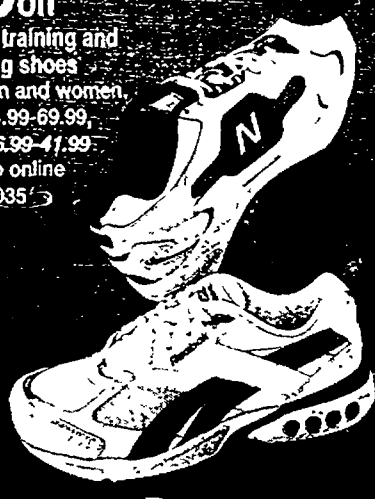

Reebok new balance

**24<sup>99</sup>**

Urban Pipeline™ Jammies

GBX Street

Urban Pipeline™ Jammies

GBX

Entire stock  
**50-60% off**

Books  
You'll want to read  
Croft & Barrow  
Sonoma  
Croft & Barrow  
orig. \$29.99  
sale 14.99-19.99



SONOMA NINE Unlisted

# SPECIALS

6am to Noon only  
Selected Early Birds also available online.

EARLY BIRD SPECIAL



**199<sup>99</sup>**  
DVD player

EARLY BIRD SPECIAL



**55% off**  
entire stock  
Trim-A-Tree

EARLY BIRD SPECIAL



**50% off plus**  
save an extra 10%  
all holiday tabletop

EARLY BIRD SPECIAL

**10-50% off plus**  
save an extra 10%  
All floor care  
shop online H1400

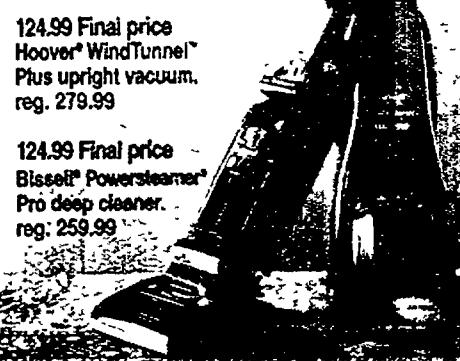

124.99 Final price  
Hoover® WindTunnel™ Plus upright vacuum, reg. 279.99  
124.99 Final price  
Bissell® PowerSteamer™ Pro deep cleaner, reg. 259.99

EARLY BIRD SPECIAL

**79<sup>99</sup>** Sonoma 6-pc. family luggage set reg. 159.99

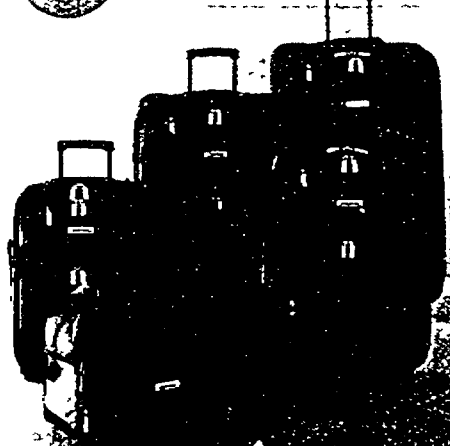

EARLY BIRD SPECIAL

Entire stock  
**55% off**  
Flannel bedding  
Choose from sheet sets, comforter sets and comforter covers.  
shop online H1240

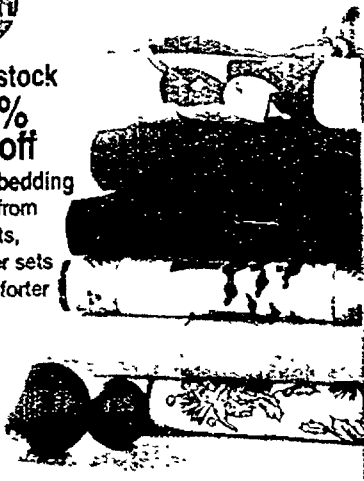

EARLY BIRD SPECIAL

**5<sup>99</sup>**  
Martex® Luxor Egyptian cotton bath towel 30x56", 16 colors, reg. 13.99

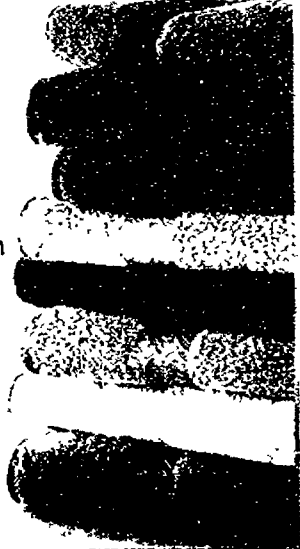

EARLY BIRD SPECIAL

Save **50%**  
Excilibr® handheld



EARLY BIRD SPECIAL

**79<sup>99</sup>** MP3 player  
Display shows artist, title of track and time, orig. 109.99



EARLY BIRD SPECIAL

Queen or king size  
**39<sup>99</sup>**  
Home Classics® 320-thread count sateen luxury sheet set  
Choose from damask stripes or woven dot  
Available in queen & king sizes  
orig. \$99.99

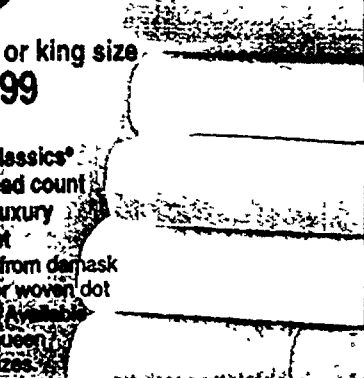

EARLY BIRD SPECIAL

Entire stock  
**50% off**  
Quilt sets from Sonoma





# super satu

## one day savings for misses

**19.99**

Briggs® stretch pants  
for misses & petites.  
orig. \$36  
Women's  
orig. \$40-\$44, sale 24.99

**40-50% off**

petites' sportswear  
Selected styles.  
orig. \$16-\$44, sale 9.60-26.40

**26.99**

Levi's® 550™ Relaxed Fit,  
550™ Stretch Boot Cut,  
505® Straight Leg or  
512™ Slim Fit Stretch jeans  
for misses

**21.99**

Gloria Vanderbilt® Amanda  
Classic Stretch jeans  
for misses and petites.  
Women's sale 24.99

**24.99**

Lee® Slim Fit Stretch,  
Relaxed Fit or Side Elastic  
Utility jeans or Plain Front  
Stretch Twill pants  
for misses and petites

**40-50% off**

women's sportswear  
Selected styles  
Sizes 1X-3X & 16W-24W  
orig. \$18-\$66, sale 9.00-39.60

**50% off**

entire stock  
dresses and pantsuits  
for misses  
orig. \$40-\$90, sale \$20-\$45

**60% off**

maternity apparel  
for misses. Selected styles  
orig. \$20-\$48, sale 6.00-19.20

Entire stock

**40-50% off**

Knits and sweaters  
for misses, petites  
and women  
from Croft & Barrow,  
Sonoma, Crystal-Kobe,  
Carolyn Taylor, Jason  
Maxwell, Pointelle,  
World Republic, J.A.C.  
Selected styles. Misses' shown.  
orig. \$16-\$48, sale 9.60-28.80



Entire stock

**50% off**

Winter  
outerwear  
for her. Excludes  
Columbia Sportswear  
Company.  
orig. \$60-\$250,  
sale \$30-\$125  
shop online for  
selected items  
P1203106



Entire stock

**50% off**

apt. 9" leather separates  
for misses.  
orig. \$69-\$189,  
sale 34.50-94.50



**33-50% off**

All activewear for misses  
from N.Y.L., Gloria  
Vanderbilt® Sport, Fu Da®,  
daisy fuentes® sport, Erika® Sport  
orig. \$24-\$40,  
sale 14.40-26.80



**33-50% off**

All modern sportswear for misses  
from daisy fuentes®,  
Nine & Company®, access  
orig. \$20-\$89, sale 11.99-59.63  
shop online for selected  
items P1203105



**40-50% off**

Classic sportswear for  
misses, petites and women  
from Norton McNaughton®,  
Villager, Sag Harbor®, Requirements®  
Selected styles. Misses' shown.  
orig. \$29-\$72, sale 17.40-43.20

## one day savings for juniors

**40-50% off**

entire stock  
knit tops  
for juniors.  
orig. \$12-\$30, sale 7.20-18.00

**50% off**

SO... 5-pkt. jeans  
for juniors.  
reg. 29.99, sale 14.99

**16.99**

fleece tops & sweaters  
for juniors  
from Mudd®, Unionbay®  
orig. \$34

**24.99**

5-pkt. jeans for juniors  
from Paris Blues®, Mudd®, Unionbay®  
reg. 29.99



Entire stock

**35% off**

Related separates  
for juniors. orig. \$28-\$40,  
sale 18.20-26.00



Entire stock

**40% off**

Velour active pants or jackets  
for juniors.  
orig. \$26, sale 15.60

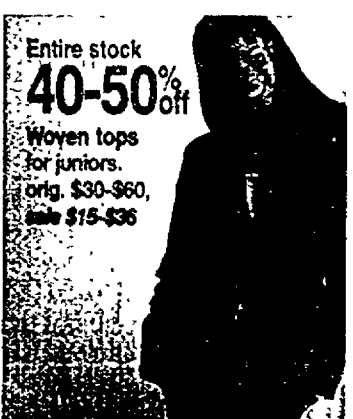

Entire stock  
**40-50% off**

Woven tops  
for juniors.  
orig. \$30-\$60,  
sale \$15-\$36



Entire stock  
**50% off**

Wool  
tops  
for juniors



# rday December 4, 6am-midnight

## 60% off all fine & sterling silver jewelry

reg. \$10-\$5,000, sale \$4-\$2,000

**Super buy**  
**28<sup>99</sup>**  
pr.  
14k gold 1/8 ct. T.W. diamond earrings  
reg. \$100 pr.  
shop online P12037

**Super buy**  
**58<sup>99</sup>**  
pr.  
14k gold 1/4 ct. T.W. diamond earrings  
reg. \$175 pr.  
shop online P12038

**Super buy**  
**198<sup>99</sup>**  
pr.  
Your choice 14k gold 1/2 ct. T.W. princess or round cut diamond stud earrings  
reg. \$600 pr.  
shop online P12039

**Super buy**  
**598<sup>99</sup>**  
pr.  
Your choice 14k gold 1 ct. T.W. princess or round cut diamond stud earrings  
reg. \$1,750 pr.  
shop online P120310

**18<sup>99</sup>**  
pr.  
Entire stock 14k gold earrings  
reg. \$50 pr.  
shop online P120311

**28<sup>99</sup>**  
pr.  
Entire stock 14k gold earrings  
reg. \$80 pr.  
shop online for selected items P120312

**Super buy**  
**98<sup>99</sup>**  
pr.  
Entire stock 10k or 14k gold 1/4 ct. T.W. diamond earrings  
reg. \$300 pr.

**Super buy**  
**198<sup>99</sup>**  
pr.  
Entire stock 10k or 14k gold 1/2 ct. T.W. diamond earrings  
reg. \$600 pr.  
shop online for selected items P120313

**38<sup>99</sup>**  
ea.  
Entire stock 10k gold gemstone pendants or pair of earrings  
reg. \$100 ea.

**48<sup>99</sup>**  
ea.  
Entire stock 10k gold gemstone pendants or pair of earrings  
reg. \$125 ea.  
shop online P120314

**Super buy**  
**198<sup>99</sup>**  
ea.  
Entire stock 10k gold 1 ct. T.W. diamond rings or 2 ct. T.W. diamond bracelets  
reg. \$600-\$750 ea.  
shop online for selected items P120300

**6<sup>99</sup>**  
pr.  
Sterling silver earrings  
reg. \$18 pr.

**9<sup>99</sup>**  
Sterling silver rings  
reg. \$25

Some jewelry photos enlarged to show detail. Diamond Total Weights are approximate. T.W. may vary up to .05 ct. Actual savings may exceed the percent savings shown.

## one day savings for her

Entire stock  
**40-50% off**  
Fashion jewelry for her from SO...so real, so right. Sonoma, Croft & Barrow  
orig. 2.00-19.99, sale 1.20-9.99  
SONOMA life+style

Entire stock  
**25-40% off**  
Watches  
reg. 19.95-475.00, sale 9.99-356.25  
shop online for selected items WZ100

Entire stock  
**40% off**  
Slippers for the family.  
orig. \$12-\$26, sale 7.20-15.60

Entire stock  
**40-50% off**  
Sleepwear, loungewear and robes for her.  
orig. \$16-\$50, sale \$8-\$25  
shop online Z100  
Featuring Nike & Company 3-pc. pajama set for her, 1 top and 2 pair of pants

Entire stock  
**55% off**  
Cold weather accessories for her. Excludes Columbia Sportswear Company.  
orig. \$5-\$50, sale 2.25-22.50  
shop online for selected items W4360

Entire stock  
**40% off**  
Handbags, minibags, handbag accessories and belts  
orig. \$8-\$75, sale 4.80-45.00  
shop online for selected items W1600

Entire stock  
**15<sup>99</sup>**  
40% off panties, shapewear & innerwear  
Excludes Jockey  
Bras from Bali, Playtex, O'ga, Barelythere, Lily of France, Vanity Fair, Maidenform, Warner's, Women's Lingerie dept. Excludes specialty bras.  
reg. \$18-\$32  
BALI

Entire stock  
**40% off**  
Cosmetic sets  
Excludes AMERICAN BEAUTY, good skin, FLIRT!  
reg. 6.50-50.00, sale 3.90-30.00  
30-40% off all other bath & body  
reg. \$3-\$30, sale 2.10-21.00



# super satu

## one day savings for men & young men

**40-50% off**  
entire stock neckwear  
for men.  
orig. \$20-\$25, sale \$10-\$15

**29.99**  
entire stock Arrow shirt jackets  
for men.  
orig. \$48-\$55

**30-50% off**  
entire stock access  
& Axist™ sportswear  
for men.  
orig. \$28-\$60, sale 18.99-42.00

**50% off**  
entire stock sport graphic tees  
for men.  
orig. \$14, sale \$7

**50% off**  
entire stock sweaters  
for men from Dockers,  
Arrow, Sonoma, Croft & Barrow.  
orig. \$36-\$130, sale 17.99-\$65.99

**50% off**  
entire stock Croft & Barrow  
robes and palamas  
for men.  
orig. \$30-\$70, sale \$15-\$35

**50% off**  
entire stock fleece tops  
for men from Arrow,  
Croft & Barrow.  
orig. \$32-\$55, sale 16.00-27.50

**19.99**  
entire stock Urban Pipeline™  
woven tops  
for young men. orig. \$24.99

**9.99**  
graphic tees  
for young men. Selected styles.  
orig. \$18

**27.99**  
Levi's® jeans  
for guys. Low Rise Straight,  
Low Loose Boot, Loose Straight,  
Cargo or Carpenter styles.

**14.99**  
entire stock SONOMA  
life+style™ carpenter jeans  
for men. orig. 34.99

**19.99**  
entire stock Urban Pipeline™  
fashion jeans & pants  
for young men. orig. 39.99

Entire stock  
**40-50% off**  
Dress shirts  
for men. orig. \$30-\$40,  
sale \$15-\$24  
Q shop online P120315

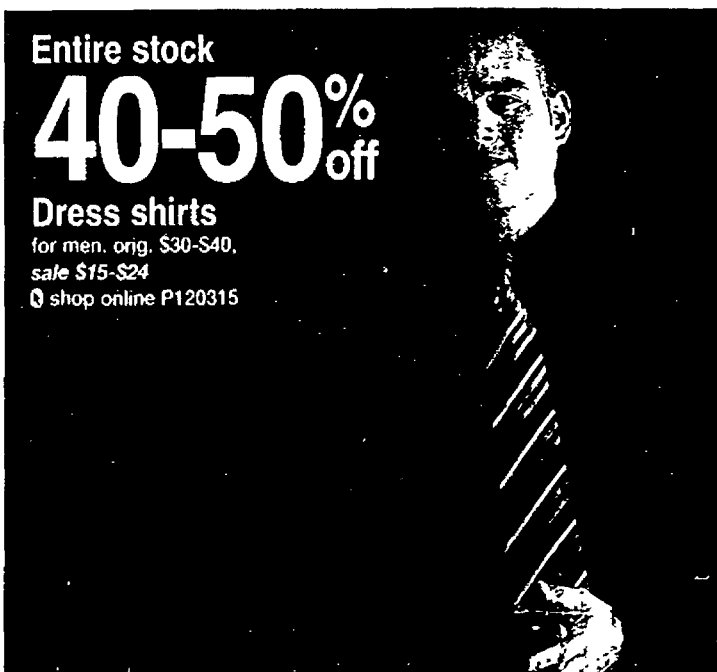

**14.99**  
entire stock Urban Pipeline™  
fashion jeans & pants  
for young men. orig. 39.99

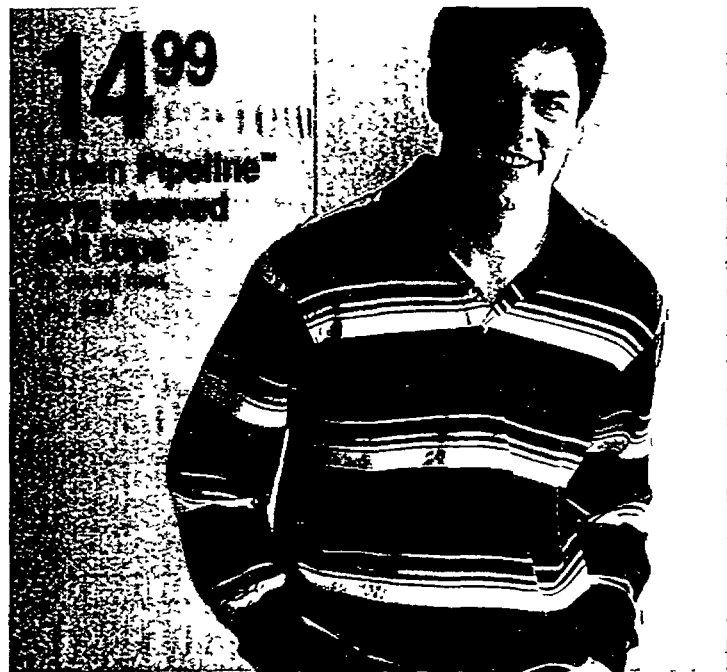

Entire stock  
**50% off**  
Outerwear  
for men. Excludes  
Dakota Sportswear  
Company®.  
orig. \$20-\$300,  
sale \$10-\$150.00  
Q shop online  
P120312



Entire stock  
**25-50%**  
Athletic apparel  
for men. orig. \$15-\$120,  
sale 9.99-60.00  
Q shop online for  
selected items M1300



Nike, adidas, Russell Athletic,  
Reebok, TekGear,  
Croft & Barrow Sport

Entire stock  
**24.99**  
Dress  
pants  
for men  
from Bragg®,  
Natural Issue®.  
reg. \$45  
Q shop  
online  
P120317

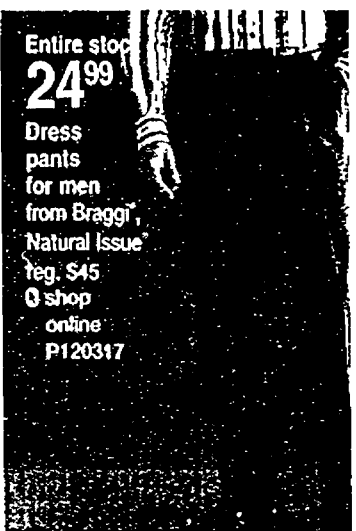

Entire stock  
**50% off**  
Croft &  
Barrow® &  
Sonoma  
loungewear  
for men.  
orig. \$20-\$24,  
sale \$10-\$12



Entire stock  
**24.99**  
Lee®  
Dungarees  
fashion jeans  
for young  
men. orig.  
29.99-39.99  
Q shop online  
P120319



**26.99**  
Levi's®  
jeans  
for men.  
505™ Regular  
Fit, 550™  
Relaxed Fit,  
559™ Relaxed  
Straight  
Fit, 560™  
Comfort Fit.  
Q shop  
online  
P120318



Entire stock  
**50-60% off**  
Sport coats  
& blazers  
for men  
from  
Dockers®,  
Haggar®,  
Sonoma,  
Croft &  
Barrow®.  
orig. \$100-\$150,  
sale \$40-\$60



Entire stock  
**50% off**  
Long sleeved knit  
tops for men  
from Arrow,  
Haggar®,  
Sonoma,  
Croft &  
Barrow®.  
orig. \$20-  
\$45, sale  
9.99-22.50



Entire stock  
**50% off**  
Woven  
sport shirts  
for men  
from Arrow,  
Haggar®,  
Sonoma,  
Croft &  
Barrow®.  
orig. \$34-\$40,  
sale \$17-\$20

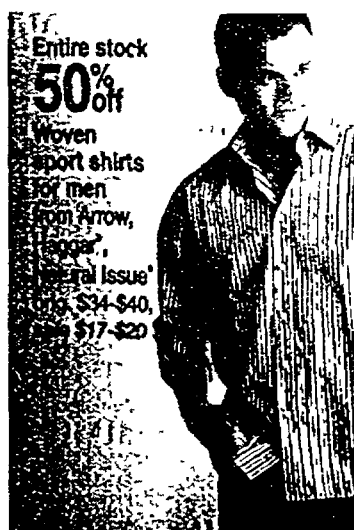

**24.99**  
Graphic  
fleece tops  
for young  
men.  
Selected  
styles.  
orig.  
\$40-\$46

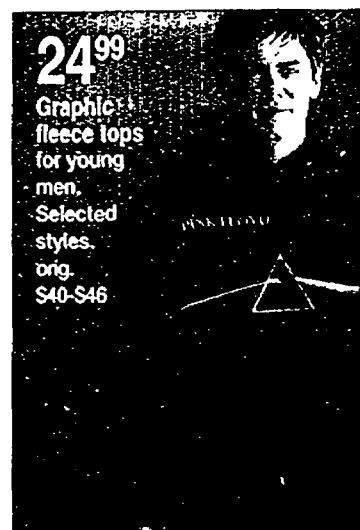

Entire stock  
**23.99**  
Croft & Barrow®  
boxed dress  
shirt & tie sets  
for men.  
orig. \$40  
Q shop online  
P120320

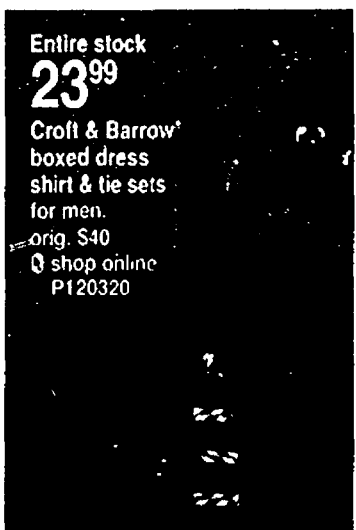

Entire stock  
**50% off**  
Gifts  
for men.  
orig. \$18-\$28,  
sale \$8-\$13



Entire stock  
**50% off**  
Cold weather  
accessories  
for men  
from Sonoma,  
Urban Pipeline™.  
orig. \$8-\$35,  
sale 4.00-17.50  
Q shop online  
for selected  
items  
M1650

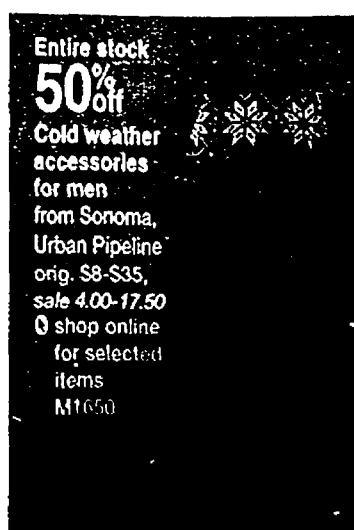

Entire stock  
**30-40% off**  
Underwear  
& socks  
for men.  
Excludes  
Jockey®.  
reg. \$10-\$22,  
sale 7.00-14.20



# rday December 4, 6am-midnight

## one day savings for boys and girls

Entire stock  
**40-50% off**  
Dress apparel  
for boys 4-20.  
orig. \$18-\$70.  
sale 10.50-42.00  
shop online  
P120322



**50% off**  
Sonoma fleece tops & pants  
for boys 4-7. Selected styles.

**50% off**  
entire stock  
character graphic tees  
for boys 4-7 & toddlers.

**50% off**  
entire stock  
U.S. Polo Assn. apparel  
for boys 4-7 & toddlers.

**50% off**  
entire stock dresses  
for girls 4-16 & toddlers.

**50% off**  
entire stock  
holiday fleece tops  
for girls 4-16.

**50% off**  
entire stock lounge pants  
for boys 8-20.  
orig. \$16-\$18 sale \$8-\$9  
shop online K4100

**50% off**  
entire stock graphic tees  
for boys 4-20.  
orig. \$16-\$22 sale 7.50-11.00

**50% off**  
entire stock  
Ocean Pacific apparel  
for boys 4-7.

**7.99**  
entire stock  
6- & 10-pk. athletic socks  
for boys.  
reg. \$10-\$12.00

**50% off**  
entire stock  
First Moments layette  
for newborns.

**50% off**  
entire stock kids' sweaters  
for boys 4-20 & girls 4-16.  
reg. \$30-\$32, sale \$15-\$16

**14.99**  
entire stock  
Urban Pipeline™ utility jeans  
for boys 8-20.  
reg. \$28

Entire stock  
**3-50% off**  
athletic apparel



Entire stock  
**50% off**  
Sleepwear  
& robes  
for girls 4-14,  
boys 4-20,  
infants and  
toddlers.  
shop online  
for selected  
items K4100

Entire stock  
**50% off**  
Outerwear  
for boys 4-20,  
girls 4-16,  
toddlers,  
infants &  
newborns.  
orig. \$30-\$125.  
sale 15.00-62.50  
shop online  
120323



Entire stock  
**10-40% off**  
Toys  
shop online  
for selected  
items: toys



Save  
**50%**  
Playwear for  
girls 4-6x,  
boys 4-7,  
toddlers  
& infants  
from  
Healthtex,  
Carter's,  
Little Tikes

Playwear not  
intended as  
sleepwear.



Entire stock  
**25-50% off**  
Socks & underwear  
for girls

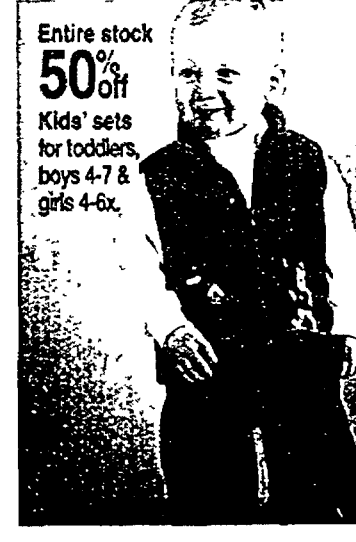

Entire stock  
**50% off**  
Kids' sets  
for toddlers,  
boys 4-7 &  
girls 4-6x.

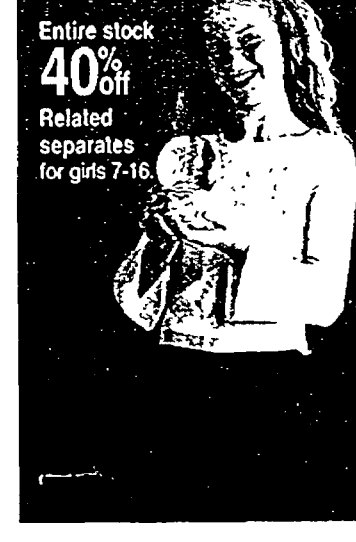

Entire stock  
**40% off**  
Related  
separates  
for girls 7-16.

**GOLD STAR CLEARANCE**

**80% off**  
and more on original prices

Get 80% off when you take an additional 70% off our already-reduced yellow ticket clearance prices. shop online: clearance

Final prices given at register. Clearance prices represent savings off original prices. Selection varies by store. Interim markdowns may have been taken. Sorry, no price adjustments given on prior purchases.



# super satu

## one day savings

**30-40% off**

entire stock  
Mudd® & I.e.i.® shoes  
for juniors.  
orig. 39.99-44.99,  
sale 27.99-31.49

**30-40% off**

entire stock  
Dockers® & Mootsies  
Tootsies® Shoes  
for Women.  
orig. 39.99-54.99,  
sale 27.99-38.49

Entire stock  
**30-50% off**

Basketball shoes  
for men or kids.  
reg. 34.99-74.99,  
sale 24.49-52.49



Entire stock  
**30-50% off**

Running shoes  
for men or women.  
reg. 44.99-79.99,  
sale 19.99-49.99



## one day savings

**50% off**

entire stock  
bed pillows &  
mattress pads  
shop online H1100

**25-50% off**

entire stock  
comforter sets, sheet sets &  
coordinating accessories

**50% off**

entire stock  
solid bathrugs  
shop online H1110

**49.99**

all sizes  
Home Classics® slipcovers  
orig. 89.99

**50% off**

entire stock  
flannel bedding  
shop online H1240

**50% off**

entire stock  
everyday table linens  
& kitchen textiles

**25-50% off**

entire stock  
sport bags  
reg. 19.99-79.99,  
sale 13.99-55.99

Entire stock  
**50-60% off**

Luggage  
reg. 49.99-319.99,  
sale 24.99-159.99  
shop online H1740



Entire stock  
**40% off**

Bath coordinates,  
accessories &  
shower curtains  
shop online  
H1130

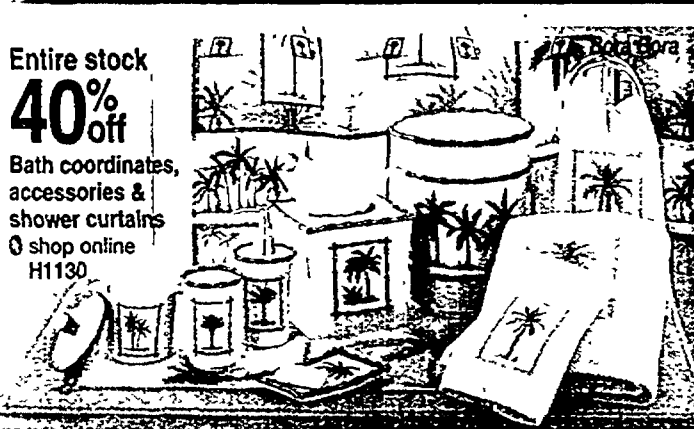

Entire stock  
**50-70% off**

Throws  
shop online for  
selected items H1330

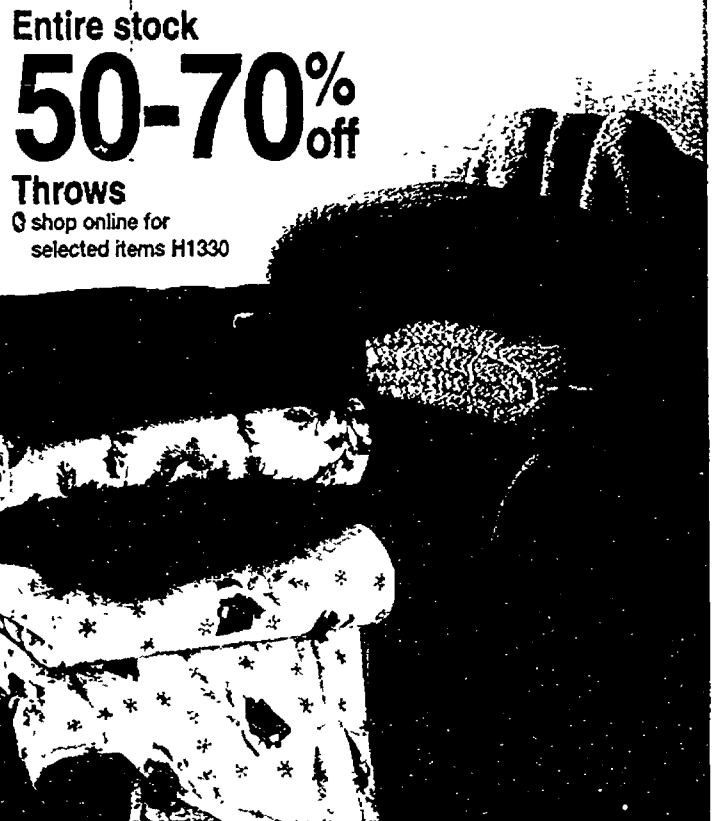

Entire stock  
**50% off**

Solid bath  
towels  
shop online  
H1111



Entire stock  
**50% off**

Blankets  
Vellux®, down,  
cotton & more.  
shop online  
H1250



Entire stock  
**50% off**

Down comforters  
& featherbeds  
shop online P120325



Entire stock  
**50% off**

Table linens,  
bath accessories  
& rugs

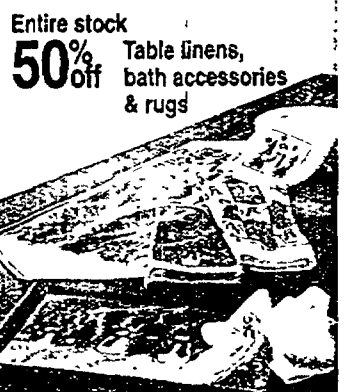

Entire stock  
**40-50% off**

Accent, area &  
kitchen rugs  
& doormats



Entire stock  
**40% off**

North American  
Enclosures™  
wall frames,  
collages &  
mirrors



Entire stock  
**40-50% off**

Frames



Entire stock  
**40-50% off**

Decorative art

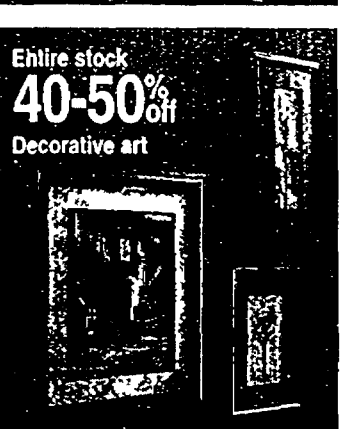

Entire stock  
**25-40% off**

Wall and boxed  
calendars  
orig. 8.99-14.99,  
sale 5.39-8.99



Entire stock  
**50% off**

Tri-A-Tex  
Excludes  
& Co.



Entire stock  
**50% off**

Gift wrap  
Excludes  
Hallmark  
& Carlton.



Save  
**50%**

Gifts & games  
Selected  
styles

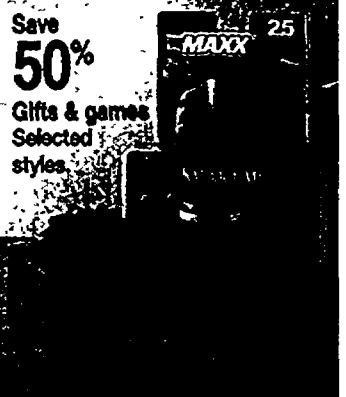

# Friday

December 4, 6am-midnight

## on all shoes and boots for the family

Entire stock  
**50% off**

Boots for her.  
orig. 49.99-99.99,  
sale 24.99-49.99



Entire stock  
**50% off**

Shoes for the family  
from SO... Croft  
& Barrow, Sonoma  
orig. 24.99-99.99,  
sale 12.49-49.99

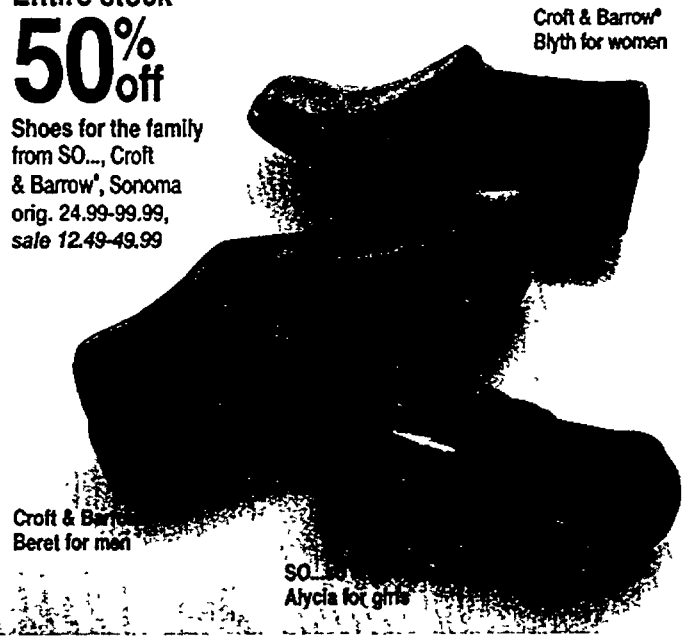

Croft & Barrow  
Blyth for women

**19.99**  
hiking boots & trail mocs  
for men. Selected styles.  
orig. 49.99

**40-50% off**  
dress & casual shoes  
for toddlers. Selected styles.  
orig. 24.99-34.99,  
sale 14.99-20.99

## for all the essentials that make your home great

Entire stock  
**10-40% off**

Kitchen electrics  
shop online H1600



sale 49.99  
Hamilton Beach®  
brew station  
coffeemaker.  
reg. 59.99

sale 29.99  
Rival® 5-qt.  
programmable  
Crock-Pot®.  
reg. 39.99

sale 199.99  
Cuisinart®  
11-cup food  
processor.  
reg. 229.99

sale 39.99  
Hamilton Beach®  
4-slice toaster. reg. 44.99

Entire stock  
**10-50% off**

Bakeware  
shop online  
BK100



Entire stock  
**50% off**

Holiday dinnerware  
shop online  
H3620



**50% off**  
entire stock  
TV trays

**30% off**  
entire stock  
bath candles  
& decorative lighting

**50% off**  
entire stock  
barware

**20-50% off**  
entire stock  
kitchen cabinets

**50% off**  
entire stock  
pantryware

**15-40% off**  
entire stock  
dental care &  
water purification

**15-50% off**  
entire stock  
razors & groomers

**25-50% off**  
entire stock  
hand vacs

**18.99**  
licensed plug & play games  
orig. 24.99

Entire stock  
**10-50% off**

Floor care  
shop online for  
selected items  
H1400



sale 14.99  
Euro-Pro®  
Shark® 7.2 volt  
Extreme Power

sale 29.99  
Dirt Devil®  
Extreme Power

Entire stock  
**10-50% off**

Personal care  
shop online  
H2700

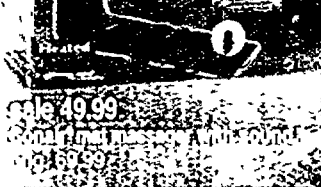

sale 49.99  
Multi-tool  
shaver. reg. 59.99

Entire stock  
**20-50% off**

Bakeware  
shop online  
for selected  
items BK100

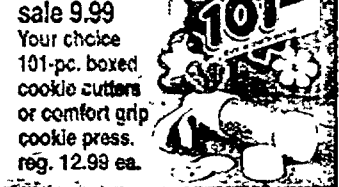

sale 9.99  
Your choice  
101-pc. boxed  
cookie cutters  
or comfort grip  
cookie press.  
reg. 12.99 ea.

Entire stock  
**40-50% off**

Family dinnerware  
shop online  
H2100



Entire stock  
**40-50% off**

Holiday candles  
& accessories



Entire stock  
**33-50% off**

Caddy  
shop online  
H1700



Entire stock  
**50% off**

Flatware  
shop online  
H2120



Entire stock  
**9.99**

Tabletop games  
orig. 19.99  
shop online  
H4340



**69.99**

Karaoke  
machine  
orig. 119.99  
shop  
online  
91696



**29.99**

Memorex® CD  
alarm clock  
orig. 39.99



Entire stock  
**50% off**

Glassware

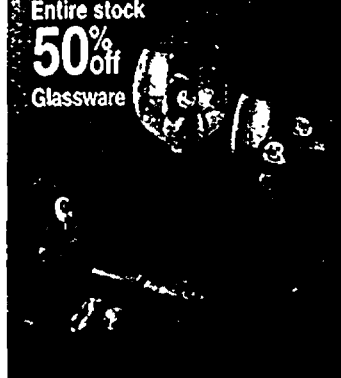



EARLY BIRD SPECIAL



EARLY BIRD SPECIAL

50-60% off family sweaters

Selected styles. orig. \$22-\$65, sale \$11-\$26

EARLY BIRD SPECIAL

Entire stock 60% off

Long sleeved knit tops for men from Arrow, Haggard, SONOMA life+style, Croft & Barrow orig. \$20-\$45, sale \$8-\$18

EARLY BIRD SPECIAL

Entire stock 65% off

Sterling silver jewelry reg. \$10-\$135, sale 3.50-47.25

sale 13.99 Sterling silver heart tag bracelet reg. \$40



shop online for selected items F999

EARLY BIRD SPECIAL

Entire stock 799

Croft & Barrow® & Sonoma knit and woven loungepants for men. orig. \$20

shop online for selected items M1410

EARLY BIRD SPECIAL

Dr. Scholl's® foot spa pedicure gift set

Entire stock 20-60% off

Personal care shop online for selected items H2400

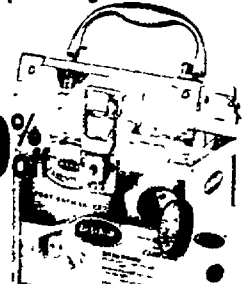

Oral-B® Sonic complete toothbrush

one day only December 4, 6am to Noon only

EARLY BIRD SPECIALS

Selected Early Birds also available online.

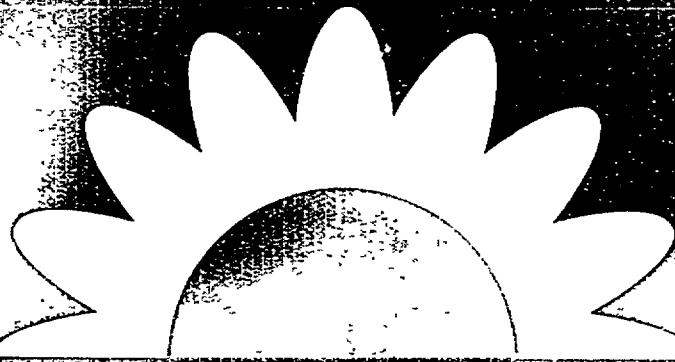

EARLY BIRD SPECIAL

Entire stock 50% off

Fashion jeans and pants for men orig. \$20-\$40, sale \$10-\$20



EARLY BIRD SPECIAL

sale 8.99 Isotoner® gloves and mittens. orig. \$20

Entire stock 55% off

Cold weather accessories for her. Excludes Columbia Sportswear Company®. orig. \$5-\$50, sale 2.25-\$22.50

shop online for selected items W4360



EARLY BIRD SPECIAL

Entire stock 55% off Frames



EARLY BIRD SPECIAL

Entire stock 55% off

Home decor orig. \$20-\$40, sale \$10-\$20



EARLY BIRD SPECIAL

Entire stock 899 Slippers for women. orig. \$20

Entire stock 1199

Slippers for men. orig. \$26



EARLY BIRD SPECIAL

Entire stock 1599

Video games from Playstation® 2, XBOX, Gameboy® Advance, Nintendo Gamecube® orig. 19.99

Video games orig. 12.99, sale 8.99

Video games orig. 12.99, sale 8.99



EARLY BIRD SPECIAL

Entire stock 9999

Digital slim camera orig. 149.99

16 MB memory 2.0 LCD screen

16 MB memory 2.0 LCD screen

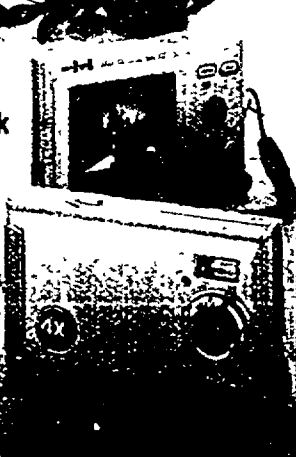

EARLY BIRD SPECIAL

Your choice 1299

Character pillows & throws orig. 24.99-29.99 ea.

50-60% off all other decorative pillows



KOHL'S

Prices good Saturday, December 4, 2004.

Store Hours: Saturday, December 4, 6am-Midnight

\*Sale prices and percentage savings offered in this advertisement are discounts from Kohl's "Regular" or "Original" prices. The "Regular" or "Original" price of an item is the former or future offered price for the item or a comparable item by Kohl's or another retailer. Actual sales may not have been made at the "Regular" or "Original" prices, and intermediate markdowns may have been taken. Clearance merchandise is excluded from "Entire Stock" promotions in this advertisement. In some events, actual savings may exceed the percent savings shown. KOHL'S® and KOHL'S brand names are trademarks of Kohl's Illinois, Inc. ©2004 Kohl's Department Stores, Inc.

more savings

Open a Kohl's Charge and receive additional discounts 12 times a year. Subject to credit approval. See store for details. fits your budget

For the Kohl's Store nearest you call 1-800-837-1500 or visit us on the Web at Kohls.com

fabric crafts  
floral decor

**JO-ANN**<sup>TM</sup>  
experience the creativity<sup>®</sup>

Sunday - Saturday,  
Dec. 5 - 11, 2004

**60% OFF**  
Holiday  
Floral...



**60% OFF**  
Holiday  
Houses...

**60% OFF** Holiday  
Ribbon...

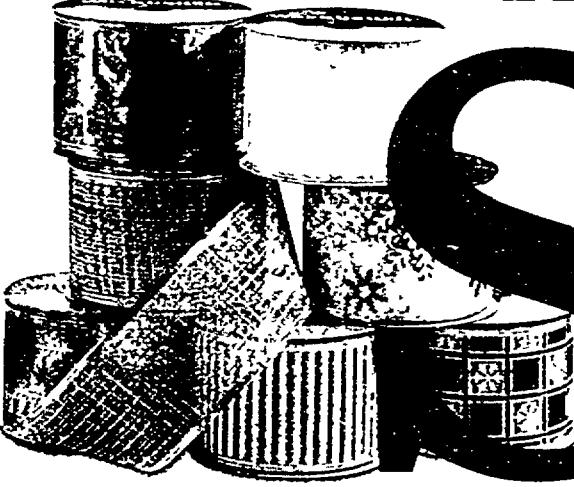

**60% OFF**

ENTIRE STOCK  
SANTA'S WORKBENCH<sup>®</sup>  
Holiday Decor & more

**sale**



**60% OFF**  
Trim-a-Tree  
Collections  
Ornaments, garlands,  
tree toppers & tree skirts in  
5 coordinated themes.  
Reg. 9.99-49.99 ea. Sale 3.99-19.99 ea.

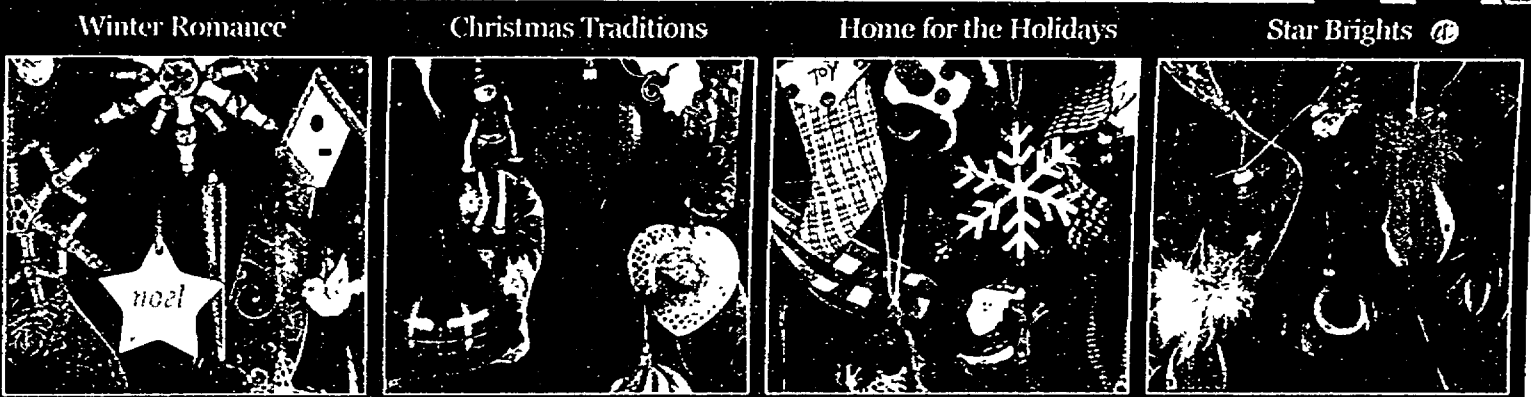

Save On All Your Scrapbooking Essentials!

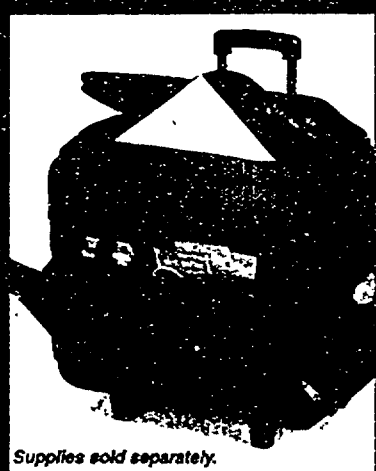

**50% OFF**  
JO-ANN SCRAP ESSENTIALS<sup>™</sup>  
SCRAPBOOK TOTE  
Easily take your scrapbook  
supplies wherever you go!  
Reg. 59.99 ea. Sale 29.99 ea.



**50% OFF** THE STACK<sup>™</sup>  
VALUE PACK PAPER  
120-180 sheets in 12"x12"  
Many designs  
Reg. 19.99 ea. Sale 9.99 ea.

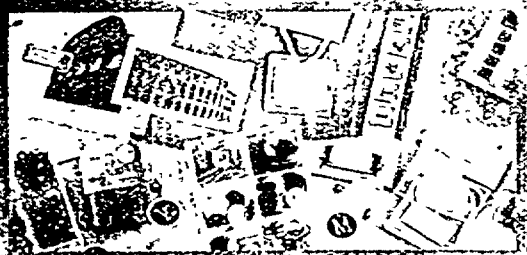

**50% OFF** JO-ANN SCRAP ESSENTIALS<sup>™</sup>  
EMBELLISHMENTS  
Brads, tags, charms, alphabets,  
eyelets, bookplates & other eccents.  
Reg. 1.99-12.99 ea. Sale 99¢-6.49 ea.

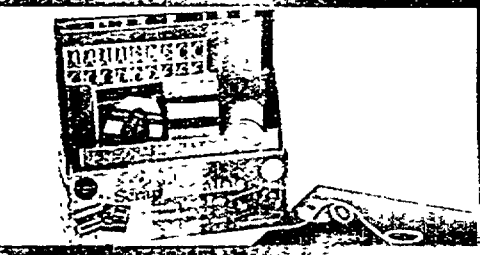

**50% OFF** JO-ANN SCRAP ESSENTIALS<sup>™</sup>  
SCRAPBOOK KIT  
10-page album, 30 card stock  
sheets, stickers, tags  
& embellishments  
Reg. 29.99 ea. Sale 14.99 ea.



**50% OFF** GARTNER<sup>®</sup>  
HOLIDAY STATIONERY  
Papers, seals & photo cards.  
Easy to use with your printer.  
Reg. 1.99-6.99 ea. Sale 99¢-3.49 ea.



**50% OFF** ENTIRE STOCK  
SCRAPBOOK ALBUMS  
Archive quality 8 1/2"x11" & 12"x12"  
in fabric or washable covers.  
Reg. 5.99-39.99 ea. Sale 2.99-19.99 ea.



**5 FOR \$1** OPEN STOCK  
PAPER  
8 1/2"x11" & 12"x12"  
Dozens of patterns & solids. Reg. 39¢-59¢ ea.

**40% OFF**

Coupon valid Sun.-Sat., Dec. 5-11, 2004  
The REGULAR PRICE  
of Any ONE Item\* **JO-ANN**

Limit one coupon per customer. Cannot be combined with any other discount or coupon. Reproductions not accepted. Must be surrendered at time of transaction. \*Offer excludes previous purchases; purchase of gift cards; classes; custom framing & floral services; iron; sewing machines & sewing machine department merchandise. A single cut of by-the-yard merchandise equals one item. Valid at any Jo-Ann store.



24 04346 02 001 040 6

**50% OFF**

Coupon valid Sun.-Sat., Dec. 5-11, 2004  
CUSTOM FRAMING **JO-ANN**  
total order Includes preservation glass, frame,  
mat & expert assembly.

We honor competitor's coupons! Plus, bring in any competitor's written quote, and we'll beat it by 10%. New orders only. Limit 1 coupon per visit. Cannot be used with any other discount or coupon. Reproductions not accepted. Must be surrendered at time of transaction. Valid at any Jo-Ann store with Custom Framing.



22 04346 99 001 000 8



Fill Your Holiday with Nature's Beauty!



WINTER ROSE COLLECTION

**60% OFF**

ENTIRE STOCK  
INTERIOR ACCENTS®  
FASHION STEMS  
Our most elegant  
collections of  
lifelike stems.  
Reg. 1.99-12.99 ea.  
Sale 79c-5.19 ea.



# Real Savings For the Season!

# 60% OFF

Holiday Floral

- Wintergreens
- Holiday Foliage
- Holiday Finished Arrangements
- Holiday Baskets & Containers

Reg. 49c-199.99 ea. Sale 19c-79.99 ea.

## ENTIRE STOCK SANTA'S WORKBENCH® Christmas Trees

Collection includes trees with lights & hinged branches for easy set-up. 4'-9' tall.  
Reg. 79.99-699.99 ea. Sale 31.99-279.99 ea.



4' OREGON FIR  
200 clear lights!  
SALE 31<sup>99</sup>

7.5' PENCIL PINE  
SALE 59<sup>99</sup>

7.5' MOUNTAIN SPRUCE  
SALE 79<sup>99</sup>

7' DOWNSWEPT SLIM MONTEREY PINE  
600 multi-colored or clear lights!  
SALE 79<sup>99</sup>

### SAVE 60% Exclusive Jo-Ann Styles!



6.5' ROCKY MOUNTAIN PINE  
560 clear lights! 67 pine cones!  
SALE 119<sup>99</sup>

7.5' WESTWOOD SPRUCE  
850 clear lights!  
SALE 159<sup>99</sup>

7.5' DOWNSWEPT RIDGE PINE  
1,000 multi-colored or clear lights!  
SALE 199<sup>99</sup>

9' CASHMERE FIR  
1,650 clear lights!  
SALE 279<sup>99</sup>

### Great Hostess Gifts!

**60% OFF**

ENTIRE STOCK  
SANTA'S WORKBENCH®  
ENTERTAINING ESSENTIALS

Tablecloths, cups, table settings, candy dishes & other favorites to make party planning fun & easy!  
Reg. 1.99-34.99 ea.  
Sale 79c-13.99 ea.



TRIVET & COASTERS  
6.99-12.99 EA.

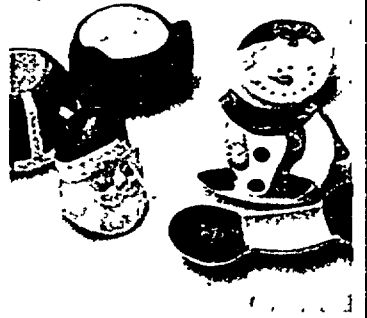

3-PC. CANDY DISHES 14.99 SET

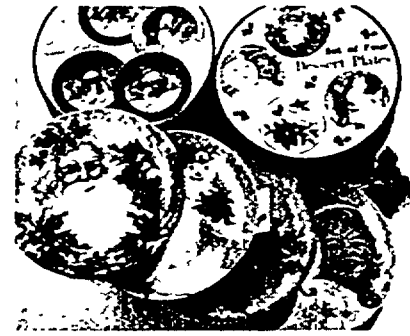

4-PC. NOSTALGIA PLATE SET IN PRINTED BOXES 19.99 SET

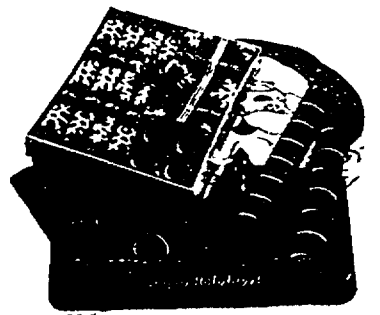

12-PC. PLACE MAT & NAPKIN SET 24.99 SET

### Gift Wrap Glitz!

**60% OFF**

ENTIRE STOCK  
SANTA'S WORKBENCH®  
HOLIDAY RIBBON

Hundreds of styles!  
Reg. 1.99-24.99 ea.  
Sale 79c-9.99 ea.



**60% OFF** ENTIRE STOCK  
SANTA'S WORKBENCH®  
COORDINATING BAGS & TINS  
Cookie tins, gift bags & canisters.  
Reg. 1.49-9.99 ea. Sale 59c-3.99 ea.

**60% OFF**

ENTIRE STOCK  
SANTA'S WORKBENCH®  
INDOOR DECOR & CANDLES

5 collections of wall hangings, tabletop decor & fabric dolls.  
Reg. 59c-129.99 ea.  
Sale 23c-51.99 ea.



**SAVE 60%**  
1<sup>99</sup> EA SANTA'S WORKBENCH®  
SCENTED MUG CANDLES  
In 4 scents. Reg. 4.99 ea.

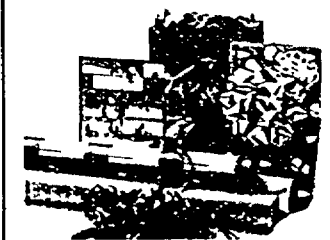

**60% OFF** ENTIRE STOCK  
SANTA'S WORKBENCH®  
GIFT WRAP  
Reg. 49c-19.99 ea. Sale 19c-7.99 ea.



**SAVE 60%**  
3<sup>99</sup> SET SANTA'S WORKBENCH®  
10-PK. GIFT BOX SET  
Sizes from large to small to fit all your gift needs.  
Reg. 9.99 set



**SAVE 60%**  
3<sup>99</sup> EA SANTA'S WORKBENCH®  
60-CT. BAG OF BOWS  
In all the colors of the season!  
Reg. 9.99 ea.

**60% OFF**

ENTIRE STOCK  
SANTA'S WORKBENCH®  
HOUSES & ACCESSORIES

4 collectible series, including miniature houses & charming accessories.  
Reg. 1.99-69.99 ea.  
Sale 79c-27.99 ea.



## Jo-Ann is your Christmas CraftQuarters!



**7<sup>99</sup> EA**  
WILTON®  
GINGERBREAD HOUSE KIT  
No-bake fun family activity!  
Reg. 12.99 ea.  
GREAT VALUE BAKEWARE  
Reg. 12.99 ea.

**30% OFF** ALL OTHER WILTON® CHRISTMAS BAKEWARE  
Reg. 1.49-9.99 ea. Sale 1.04-6.99 ea.



**50% OFF** READY-TO-FINISH ORNAMENTS  
Wood & plaster styles.  
Reg. 59c-4.99 ea.  
Sale 29c-2.49 ea.



**50% OFF** READY-TO-FINISH HOLIDAY WOOD, PLASTER, TIN & PAPER MACHE  
Reg. 1.49-12.99 ea. Sale 74c-6.49 ea.



**40% OFF** HOLIDAY BUTTONS  
Reg. \$1-2.99 card  
Sale 60c-1.79 card



**30% OFF** ENTIRE STOCK STICKERS  
Hundreds of choices from Mrs. Grossman's, Stickopotamus, Frances Meyer, Sandylion, Me & My Big Ideas, Creative Imaginations, Die Cuts With a View & Colorbok®.  
Reg. 1.29-19.99 ea. Sale 90c-13.99 ea.

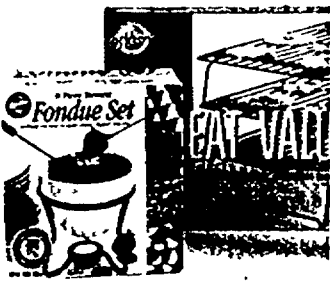

**50% OFF** READY-TO-FINISH MULTI-PACK GLASS ORNAMENTS  
Reg. 3.99 pk. Sale 1.99 pk.



**50% OFF** HOLIDAY TRIMS  
Reg. 1.19-7.99 ea.  
Sale 59c-3.99 ea.



**79c EA** SCRIBBLES® 1-OZ. FABRIC PAINT  
Reg. 99c ea.

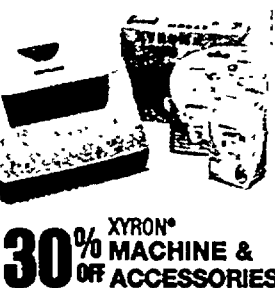

**30% OFF** XYRON® MACHINE & ACCESSORIES  
Reg. 1.99-119.99 ea.  
Sale 1.39-83.99 ea.



**25% OFF** ENTIRE STOCK JEWELRY-MAKING SUPPLIES  
Reg. 49c-39.99 ea. Sale 36c-29.99 ea.



# 40% OFF

ENTIRE STOCK  
**Sew Comfy Flannel & Flannel-Back Satin**  
Reg. 4.99-9.99 yd.  
Sale 2.99-5.99 yd.

**Micro Fleece Prints & Solids**  
Reg. 9.99-14.99 yd.  
Sale 5.99-8.99 yd.

**Plaid Flannel**  
Reg. 5.99-6.99 yd.  
Sale 3.59-4.19 yd.

**Snuggle Flannel Prints**  
Reg. 4.99-12.99 yd.  
Sale 2.99-7.79 yd.

**Fleece Prints, Panels & Embroideries**  
Excludes licensed designs.  
Reg. 9.99-16.99 yd.  
Sale 5.99-10.19 yd.



# 50% OFF

**Brocades**  
Reg. 9.99-16.99 yd. Sale 4.99-8.49 yd.  
**Royalty Velvet**  
Reg. 12.99 yd. Sale 6.49 yd.  
**Casa Collection**  
Reg. 5.99-7.99 yd. Sale 2.99-3.99 yd.  
**Glitz & Glamour Silky Prints & Solids**  
Reg. 9.99 yd. Sale 4.99 yd.

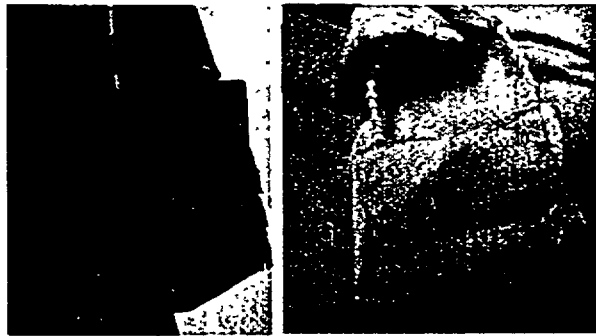

Casa Satin with Beaded Trim, left. Silky Solids, right.  
Handbags: Butterick 6907

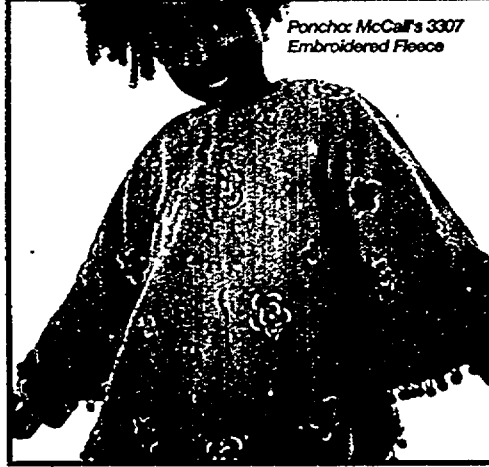

Poncho: McCall's 3307 Embroidered Fleece



## Quick & Easy Gift Ideas!

# 50% OFF

**Holiday Packaged Gifts**

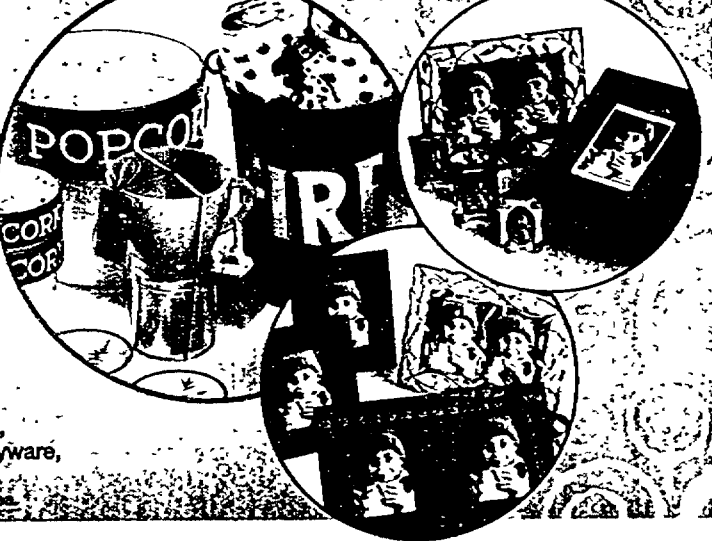

Featuring frames, candle sets, photo albums & storage, partyware, pet favorites & home accents.  
Reg. 4.99-29.99 ea. Sale 2.49-14.99 ea.

# 40% OFF

ENTIRE STOCK  
**Framed Art & Mirrors**

Reg. 5.99-229.99 ea.  
Sale 3.59-137.99 ea.

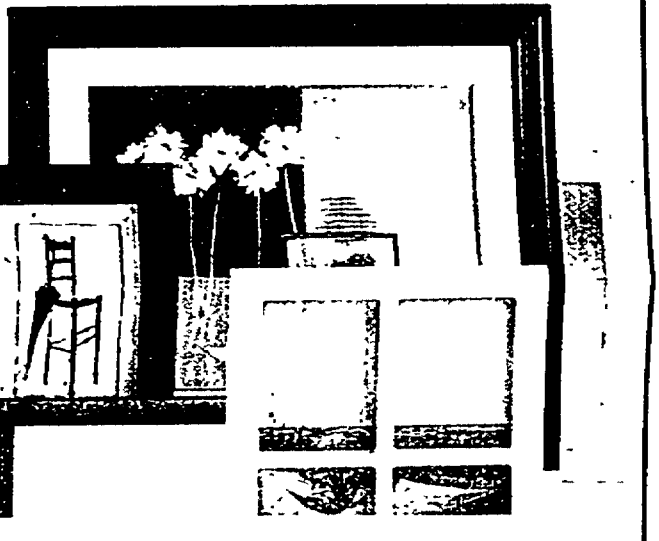

# 40% OFF

**INTERIOR ACCENTS® RENAISSANCE COLLECTION**  
Reg. 4.99-49.99 ea.  
Sale 2.99-29.99 ea.

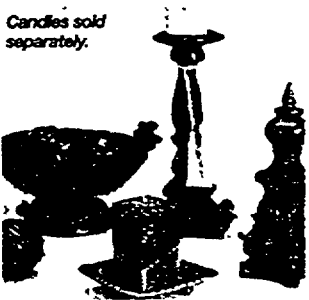

Candles sold separately.

# 40% OFF

**INTERIOR ACCENTS® HOME BASICS COLLECTION**  
Reg. 4.99-149.99 ea.  
Sale 2.99-89.99 ea.

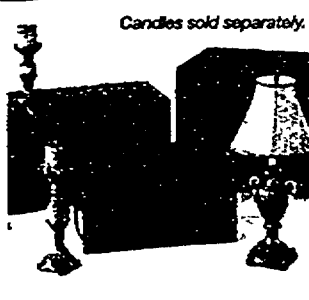

Candles sold separately.

# 30% OFF

**MARKET FRESH CANDLE COLLECTION**  
Reg. 9.99-16.99 ea.  
Sale 6.99-11.89 ea.



A Jo-Ann Exclusive!

# 30% OFF

ENTIRE STOCK  
**INTERIOR ACCENTS® BASIC CANDLES & HOLDERS**  
Reg. 5.99-19.99 ea.  
Sale 4.19-13.99 ea.



# 9.99 EA

**SPECIAL BUY 18" DECORATIVE PILLOWS**  
100% polyester fiberfill in an array of styles & colors.



# 7.99 YD

**SIGNATURE SERIES™ 54" DECORATOR FABRICS**  
• SOLIDS • MOIRE  
• SILKESSE Reg. 9.99 yd.



# 40% OFF

ENTIRE STOCK  
**LAMP SHADES & BASES**  
Mix & match to suit your decor.  
Reg. 2.99-129.99 ea.  
Sale 1.79-77.99 ea.

## The Best in Yarn, Priced Right!

# 3.99 EA

**PATONS® CHA CHA YARN**  
Hand wash, dry flat. Super bulky weight. Reg. 4.49 ea.

# 1.99 EA

**LION BRAND® WOOL-EASE® YARN**  
Machine wash & dry. 3 oz. Medium weight. Reg. 2.49 ea.

Jo-Ann Exclusives!

# 4.99 EA

**PATONS® EVITA YARN**  
Machine wash & dry. 1 1/2 oz. Super bulky weight. Reg. 5.99 ea.

# 4.99 EA

**PATONS® VOODOO YARN**  
Machine wash & dry. 1 1/2 oz. Super bulky weight. Reg. 5.99 ea.

# 2.49 EA

**LION BRAND® HOMESPUN® BABY YARN**  
3 oz. medium weight. Reg. 2.99 ea.

# 3.99 EA

**LION BRAND® BOUCLE YARN**  
Machine wash & dry. 2.5 oz. medium weight. Reg. 4.99 ea.

## Gifts That Are Sew-Simple!

# 30% OFF

**GINGHER DESIGNER SERIES "LINDSAY" SCISSORS**  
8" dressmaker shears & 4" embroidery scissors.  
Reg. 34.99 & 44.99 ea.  
Sale 24.49 & 31.49 ea.

# 9.99 EA

**KLASSE GOLD EMBROIDERY SCISSORS GIFT SET**  
Contains 4 1/2" embroidery scissors, 16 embroidery & 6 hand needles, & a thimble. Reg. 14.99 ea.

A Jo-Ann Exclusive!

# 15.99 EA

**LEISURE ARTS® BLOCK EXPLOSION BOOK**  
Find quick & easy quilt designs! 96 pages. Reg. 19.95 ea.

# SAVE \$10

**MUNDIAL® 8" DRESSMAKER SCISSORS**  
18-karat gold-plated handles. Reg. 29.99 ea.

Merchandise selection varies by store. Fabric contents & widths may vary. ©S



# SUPER

Sat. & Sun., Dec. 11 & 12 ONLY!

# up to 70% OFF



## holiday

**70% OFF** SANTA'S WORKBENCH®  
**Mega Ribbon Spools**  
10-YD. Reg. 5.99 ea. Sale 1.79 ea.  
25-YD. Reg. 12.99 ea. Sale 3.69 ea.

**75% OFF** SANTA'S WORKBENCH®  
**3-Yd. Narrow Ribbon Spools** Reg. 1.99 ea. Sale 49¢ ea.

**70% OFF** SANTA'S WORKBENCH®  
**120-Sq. Ft. Gift Wrap Rolls**  
Reg. 9.99 ea. Sale 2.99 ea.

**70% OFF** SANTA'S WORKBENCH®  
**Glass Ornament Sets**  
Reg. 9.99 set Sale 2.99 ea.

**50% OFF** ENTIRE STOCK  
**Packaged Tapes & Braids**  
Reg. 99¢-7.99 ea. Sale 49¢-3.99 ea.

**50% OFF** ENTIRE STOCK  
**Baskets**  
Reg. 3.99-119.99 ea. Sale 1.99-59.99 ea.

**29.99 EA** SANTA'S WORKBENCH®  
**4' Pre-Lit Oregon Fir Christmas Tree** Ⓜ  
200 clear lights! Reg. 79.99 ea.

## decor

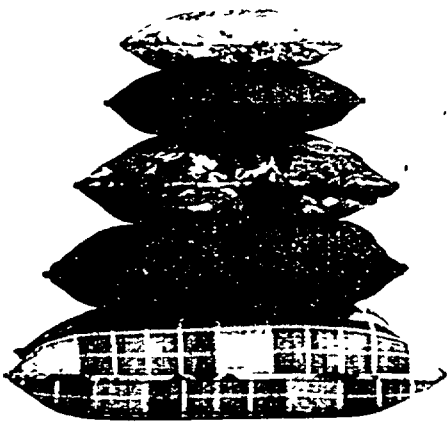

**50% OFF** ENTIRE STOCK  
**Home Decor Print & Solid Fabrics**  
Reg. 7.99-49.99 yd. Sale 3.99-24.99 yd.

**50% OFF** ENTIRE STOCK  
**Value Flatfold Fabrics**  
Reg. 1.96-14.96 yd. Sale 98¢-7.48 yd.

**50% OFF** Red Tag Decorator  
**Fabrics**  
Reg. 2.99-19.99 yd. Sale 1.49-9.99 yd.

**50% OFF** Decorative  
**Drapery Hardware**  
Reg. 4.99-34.99 ea. Sale 2.49-17.49 ea.

**50% OFF** Basic Wood & Fabric  
**Tabletop Frames**  
2"x3" to 8"x10" sizes.  
Reg. 1.99-6.99 ea. Sale 99¢-3.49 ea.

## crafts



*Pillows & Mantel Dressing: Simplicity 7846 'Tis the Season' Christmas Fabric*  
Stockings, from left to right: McCall's 2991, Embroidered Corduroy & 'Tis the Season' Print; McCall's 2991, Brocade; Butterick 3615, 'Tis the Season' Print; Butterick 5783, 'Tis the Season' Patchwork Print; Butterick 5783, Corduroy

**60% OFF** ENTIRE STOCK 'TIS THE SEASON'®  
**Christmas Fabrics**  
Reg. 3.99-14.99 yd./pnl.  
Sale 1.59-5.99 yd./pnl.

**60% OFF** Holiday Stitch &  
**Latch Hook Kits**  
Reg. 99¢-59.99 ea. Sale 39¢-23.99 ea.

**60% OFF** READY-TO-FINISH  
**Holiday Wood, Plaster, Tin & Paper Mache** Ⓜ  
Reg. 1.49-12.99 ea. Sale 59¢-5.19 ea.

**60% OFF** READY-TO-FINISH  
**Ornaments**  
Wood, plaster & paper mache, plus glass multi-packs.  
Reg. 59¢-4.99 ea./pk. Sale 23¢-1.99 ea./pk.

**4 FOR \$1** Craft Bags  
Reg. 59¢-69¢ ea.

**50% OFF** CARON®  
**Christmas Yarns**  
Glitter & Victorian Gold.  
8-oz. solids, 6-oz. ombres.  
Reg. 4.99 ea. Sale 2.49 ea.

**6.99 EA** WILTON®  
**Pre-baked Gingerbread House**  
Reg. 12.99 ea.

**40% OFF** ENTIRE STOCK  
**Floral Arranging Supplies**  
Reg. 79¢-19.99 ea. Sale 47¢-11.99 ea.

**30% OFF** ALREADY-REDUCED  
**STICKERED CLEARANCE**

Crafts, notions, home accents & floral.  
Excludes fabric.

## sewing

**50% OFF** COATS & CLARK®  
**Thread**  
Reg. 1.19-9.99 ea. Sale 59¢-4.99 ea.

**1.99 YD** Alova Suede Solids &  
**Corduroy Solids**  
Reg. 6.99 yd.

**50% OFF** Cozy Flannel Solids  
Reg. 3.99 yd. Sale 1.99 yd.

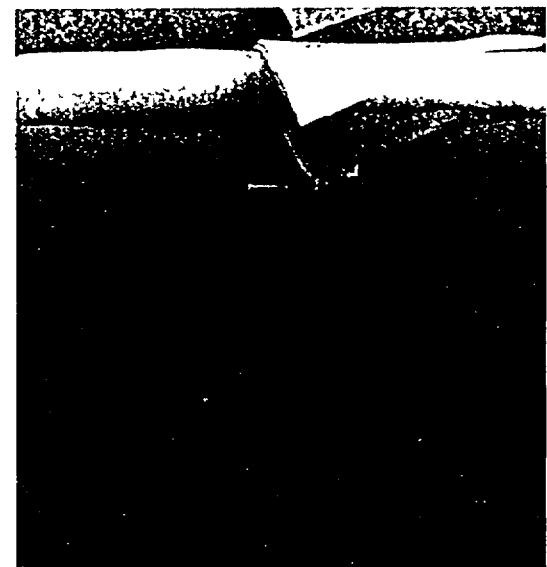

**50% OFF** Alpine Fleece Solids  
Reg. 6.99 yd. Sale 3.49 yd.

**50% OFF** OTT-LITE® TRUE COLOR™  
**13w Wing Shade Floor Lamp**  
Height adjusts 4' to 5'.  
Reg. 139.99 ea. Sale 69.99 ea.

**50% OFF** 3x Magnifier  
**Attachment**  
Extendable neck.  
Reg. 109.99 ea. Sale 54.99 ea.

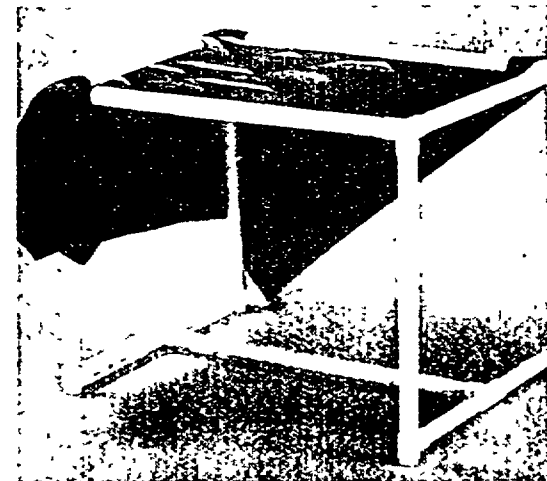

**50% OFF** Floor Quilt Frame  
Holds large quilt or bedspread.  
Reg. 99.99 ea. Sale 49.99 ea.

**30% OFF** Quilter's  
**Calico Prints**  
Reg. 2.99-7.99 yd. Sale 2.09-5.59 yd.



### The Jo-Ann Gift Card... the gift of creativity!

See Guest Services for details, or log on to [www.joann.com](http://www.joann.com), search: **giftcard**

Supplies & sewing machines not included.

### Win a Homespun Deluxe Dual Sewing Center Worth \$899<sup>99</sup>

or an online shopping spree  
at [www.joann.com](http://www.joann.com)!

Online contest only. Sweepstakes valid Dec. 2 - Dec. 31, 2004 exclusively online. No purchase necessary. Must be a legal U.S. resident 18 or older. Void where prohibited. Subject to official rules at [www.joann.com](http://www.joann.com).

Online Sweepstakes! search: **decsweeps**

### You Can Create It Clinic <sup>®</sup> Creative Kidz Event

**Holiday Scrapbook Pages**

Tuesday, Dec. 14,  
6:30-8:30pm

Saturday, Dec. 18,  
1-3pm

\$10 fee plus supplies

**Family Photo Frame**

Saturday, Dec. 18,  
10am-noon

\$2 fee, supplies included

For details on words with Creative University...



Sale Prices valid through Saturday, Dec. 11, 2004 (unless otherwise noted)

To find the store nearest you, call toll free 1-877-465-6266 or use the Store Locator at [www.joann.com](http://www.joann.com).

Holiday Shopping Hours: Sunday 10am-8pm  
Monday-Saturday 8am-10pm, Fri., Dec. 24, 8am-6pm  
Closed Christmas Day, Sun., Dec. 26, 7am-8pm Hours may vary.

Look for the symbol for items we carry only in our Jo-Ann superstores. 120604SA ©2004 Jo-Ann Stores, Inc. Merchandise selection varies by store. Fabric contents & widths may vary. If for any reason we are out of stock on advertised items, a comparable item will be offered at comparable savings. Seasonal items are limited to stock on hand & subject to prior sales. Savings are off regular prices. Regular and original prices are offering prices only, which may or may not have resulted in actual sales. Intermediate mark-downs may have been taken. Offers include some clearance items. Clearance merchandise will remain at a reduced price and will not be offered for sale at the original price again. Selection varies by store. Quantities limited to stock on hand. Special order restrictions apply. Printed in U.S.A. [www.joann.com](http://www.joann.com) experience the creativity online

# Holiday Savings on Workwear and Boots

FIELD & STREAM  
RUGGED BOOTS

ONLINE ITEM  
ID# 1062970

Wigwam 40°  
Below Socks...8.99

Thinsulate  
Men's 8" Waterproof Sport Boot  
• Nubuck leather upper  
• 200g Thinsulate insulation  
• Rubber lug outsole  
✓ Double ScoreCard Points

Save 35% OFF ORIG.

49<sup>98</sup>  
Orig. 79.99  
Now 59.99



## BOOTS



Men's 6" Steel Toe Boot  
• Nubuck leather upper  
• EVA midsole • Rubber lug outsole  
✓ Double ScoreCard Points

Save 25% OFF ORIG. 59<sup>99</sup>  
Orig. 79.99



Men's Quest Sedona Mid  
• Nubuck and suede upper  
• Compression-molded EVA midsole  
• Rubber lug outsole • Also available in low  
✓ Double ScoreCard Points

Save 33% OFF ORIG. 59<sup>99</sup>  
Orig. 89.99



—WATERPROOF/BREATHABLE—  
Men's Gore-Tex Hiker  
• Suede leather/nylon upper  
• New EVA midsole and Vibram outsole  
✓ Double ScoreCard Points

Save \$30 OFF ORIG. 69<sup>99</sup>  
Orig. 99.99



—STEEL TOE—  
Men's Pro 6" Pit Boss  
• Oiled, full-grain leather upper  
• Goodyear welt construction

Save \$10 OFF ORIG. 89<sup>99</sup>  
Orig. 99.99

ROCKY  
SHOES AND BOOTS, INC.

Thinsulate Ultra

—WATERPROOF/BREATHABLE—

Men's Timberwolf 1000

• 1000g Thinsulate insulation  
• Vibram outsole  
• Available in brown or Advantage Timber camo

Save \$80 OFF ORIG.

119<sup>99</sup>  
Orig. 199.99

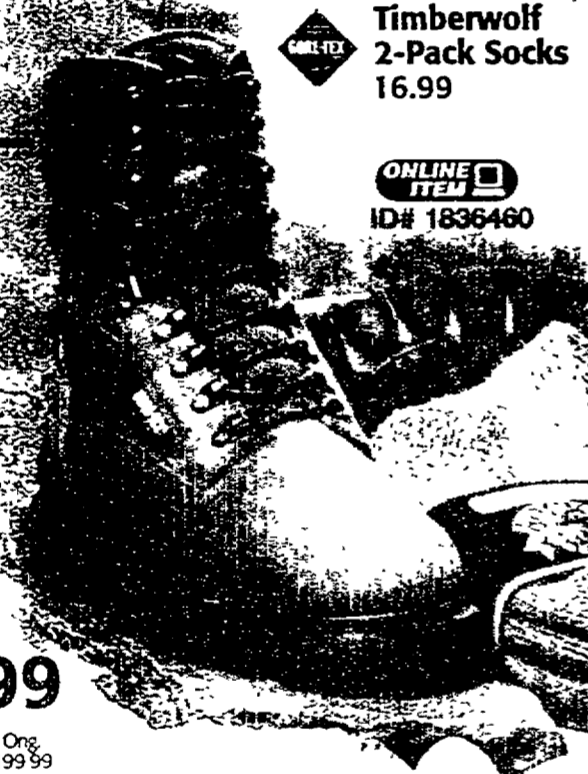

Timberwolf 2-Pack Socks 16.99

ONLINE ITEM  
ID# 1836460



—WATERPROOF—  
Men's Pac Boot  
• Molded waterproof shell • Suede leather upper • 200g Thinsulate insulation  
✓ Double ScoreCard Points

Save 25% OFF ORIG. 29<sup>99</sup>  
Orig. 39.99



—WATERPROOF—  
Men's Jasper Trac  
• Seam-sealed waterproof suede leather upper  
• 200g Thinsulate insulation • Polar-Trac outsole

Save \$10 OFF ORIG. 49<sup>99</sup>  
Orig. 59.99



Men's Kananaskis  
• Waterproof rubber foot  
• Waterproof leather upper  
• Removable felt liner

Save \$40 OFF ORIG. 59<sup>99</sup>  
Orig. 99.99



—DICK'S EXCLUSIVE—  
Men's Shadow Hunter  
• Full-grain leather upper • Gore-Tex waterproof/breathable membrane • 800g Thinsulate insulation • Rubber lug outsole

Save \$50 OFF ORIG. 94<sup>98</sup>  
Orig. 189.99  
Now 99.99

Carhartt

Jacket...69.98  
Reg. 84.99 (Shown)

Bib...74.98  
Reg. 89.99 (Shown)

ONLINE ITEM  
ID# 1858264

All Carhartt Jackets, Bibs and Sweat Jackets

Save

\$15



## WORKWEAR • RUGGED



All Northeast Outfitters Workwear and Work Accessories

• Choose from jackets, sweat jackets, bibs, hats and gloves  
✓ Double ScoreCard Points

Take an Extra 20% OFF



Men's Levi's® Jeans

• Choose from 505®, 550™, 560™ and carpenter styles in various washes  
• Not available in all stores  
Orig. 34.99-40.00  
Now 29.99

Save 30% OFF ORIG. 26<sup>99</sup>

Men's Northeast Outfitters Carpenter Jeans...24.99 Orig. 34.99  
• Not available in all stores

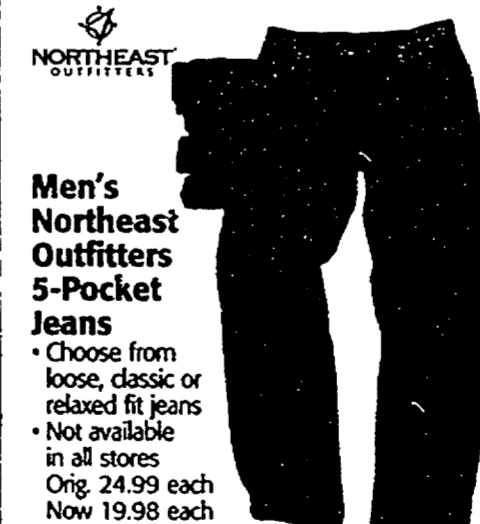

Men's Northeast Outfitters 5-Pocket Jeans

• Choose from loose, classic or relaxed fit jeans  
• Not available in all stores  
Orig. 24.99 each  
Now 19.98 each  
✓ Double ScoreCard Points

Save 40% OFF ORIG. 2 for \$30



Men's Northeast Outfitters Basic Flannels

• Available in a variety of plaids  
• Men's Tall sizes available  
Reg. 16.99-19.99 each  
✓ Double ScoreCard Points

Save \$50 OFF ORIG. 2 for \$20

✓ Double ScoreCard Points not available in all locations

DICK'S  
SPORTING GOODS

Shop us online at DicksSportingGoods.com or order by phone at 1.877.846.9997



# The Best Brands in Outerwear for A Warm Holiday Season

## OUTERWEAR

Men's or Women's  
Fleece Vest... 24.99  
Reg. 35.00



Men's Steens  
Mountain or Women's  
Benton Springs Fleece  
• 100% MTR fleece  
• Full-zip front • Drawcord at hem



Save 25% OFF ORIG. **29.99**  
Orig. 40.00



— WATER RESISTANT —  
Men's or Women's  
Falmouth Parka  
• Water-resistant Bergundtal nylon outer shell  
• Available in Men's Tall sizes



Save \$30 OFF ORIG. **49.99**  
Orig. 80.00



Women's or Men's  
Khumbu Fleece Jacket  
• Midweight fleece jacket with full front zip  
• Adjustable drawcord at hem



Save \$19 OFF ORIG. **79.98**  
Reg. 99.00



— WINDPROOF —  
Men's XLV Soft Shell Jacket  
• 4-way stretch windproof fabric  
• Omni-Bloc stretch soft shell



Save \$25 OFF ORIG. **99.99**  
Orig. 125.00



— WATERPROOF/  
BREATHABLE —

Women's  
Misty Flip  
or Men's  
Trickster Parka  
• Men's Tall sizes  
available at slightly  
higher prices

Save \$80 OFF ORIG.

**159.98**  
Orig. 240.00  
Now 169.99



— WATERPROOF/BREATHABLE —  
Women's or Men's Q1 Jacket  
• Waterproof, breathable HydroProof outer shell  
• Critically seam-sealed • Zip-out fleece liner  
✓ Double ScoreCard Points

Save \$60 OFF ORIG. **129.98**  
Orig. 190.00  
Now 149.99



— INTERCHANGE SYSTEM —  
Men's Bugaboo or Women's  
Bugall Parka  
• Zip-out liner • Water-resistant  
Alpha Grid outer shell



Save \$60 OFF ORIG. **139.98**  
Orig. 200.00  
Now 149.99

Girls' Papillion Parka... 79.99  
Orig. 110.00 Online ID#1453859



— WATER RESISTANT —  
Boys' White Point Parka  
• Water-resistant Square Rip outer  
shell with FahrenHot insulation

Save \$30 OFF ORIG. **69.99**  
Orig. 100.00



— WATERPROOF/BREATHABLE —  
Girls' or Boys' Q1 Jacket  
• Waterproof, breathable outer shell  
• Critically seam-sealed • Zip-out liner  
✓ Double ScoreCard Points

Save \$35 OFF ORIG. **89.99**  
Orig. 125.00



— DICK'S  
EXCLUSIVE  
Women's  
or Men's  
Scope  
Acclimate  
Parka

• Waterproof,  
breathable  
HyVent  
outer shell  
• Zip-out liner

Save \$49 OFF ORIG.

**179.98**  
Orig. 229.00  
Now 189.99



## ACCESSORIES

SCOTT



Classic Goggle  
• Ventilation system, dual lens, plush  
E150 face foam, G-7 Spectrathane  
engineered frame compound

Save 20% **19.98**  
Reg. 24.99

MEDALIST



Men's or Women's  
Polypropylene/Wool  
Crew or Pants  
• Merino/wool outer layer • Inner layer  
wicks away moisture • Big and Tall sizes  
available at a slightly higher price

Great Value **17.99**



Youth  
14.99

180°

Adult Ear Warmers  
• Available in a variety of styles  
for various outdoor activities



Great Value **19.99**

✓ Double ScoreCard Points not available in all locations



Men's, Women's and  
Kids' Insulated Ski Gloves  
• Waterproof, breathable glove  
• Insulated for warmth • Sizes S-XL

Save 20% **9.98**  
Reg. 12.99



Women's  
or Men's  
Columbia  
Ski Pants

• Water-resistant  
shell pants  
• Zap fleece in  
seat of pants  
and knees  
Sale  
59.99-99.99  
Orig.  
80.00-125.00

Save Up To



**25%\*** Kids' Columbia Ski Bib  
29.99-44.99 Orig. 40.00-60.00  
Online ID#1878592

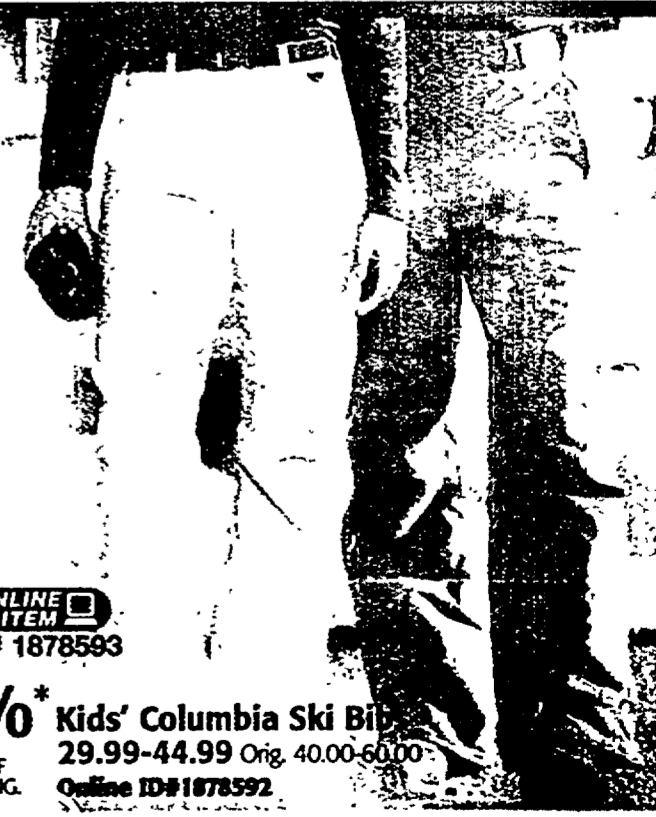

The Gift that Always Fits Purchase and redeem in-store or online.

\*Interim markdowns may have been taken

**DICK'S**  
SPORTING GOODS

EVERY SEASON STARTS AT

**DICK'S**  
SPORTING GOODS

**Gifts**  
That Score  
**Points**

Save Up To  
**50%**  
on Great  
Gifts

APPAREL

FITNESS

HUNTING

FOOTWEAR

GOLF

PAINTBALL

**Save \$75 OFF ORIG.**

**149<sup>98</sup>**

**DICK'S EXCLUSIVE—**  
**Women's Winter Harbor or Men's Hoodoo Parka**

- Interchange System parka
- Water-resistant Bergundal nylon outer shell
- Zip-out liner

Orig. 225.00  
Now 159.99

**3-IN-1 INTERCHANGE SYSTEM**

1. LINER
2. SHELL
3. JACKET

**4 WEEKS LEFT!**

**Men's Big Sizes...34.98** Orig. 49.99 Now 39.99  
Online ID# 1764969

**Kids...19.98**  
Orig. 34.99 Now 24.99

**—WATER RESISTANT—**  
**Men's or Women's Insulated Ski Bibs or Pants**

- Water-resistant nylon shell
- Attached insulation for warmth

**Save 35% OFF ORIG.** **24<sup>98</sup>**  
Orig. 39.99  
Now 29.99

**WOLVERINE**  
BOOTS & SHOES

**—WATERPROOF/BREATHABLE—**  
**Men's 8" Gore-Tex Field Boot**

- Cordura/leather upper
- 600g Thinsulate insulation

**Save \$60 OFF ORIG.** **89<sup>99</sup>**  
Orig. 149.99

**ONLINE ITEM**  
ID# 1845979

**—PEC DECK—**  
**PHE1000 Home Gym**

- Single-station home gym
- Pec deck, chest press, upper/lower pulleys, leg developer

**199<sup>98</sup>**  
Orig. 399.99  
Now 249.99

**—2.5hp MOTOR—**  
**445i Treadmill**

- 2.5hp Mach motor, 0-10mph
- 18"x50" deck, 0-10% incline
- 4-window LCD console with cooling fan
- EKG grip pulse
- Includes 1, 2, 3 lb. hand weights

**499<sup>98</sup>**  
Orig. 699.99  
Now 599.99

**Save \$200 OFF ORIG.**

**—SEMI-AUTO MARKER—**  
**TLR Paintball Kit**

- Semi-auto TLR marker with bottom line and gas through foregrip
- New-style drop forward
- 200-round loader with elbow
- 12 oz. CO<sub>2</sub> tank

**Save \$80** When Purchased as a Package

**169<sup>98</sup>** Reg. 189.99

If purchased separately a \$250 value

**—WATERPROOF—**  
**Men's Bugabootoo**

- 200g Thermolite insulation
- Also available in Women's style

**Save \$10 OFF ORIG.** **89<sup>99</sup>**  
Orig. 99.99

**Take \$100 Off All Table Games \$499.99 or more**

Online ID# 1878630  
**Take \$50 Off All Table Games \$299.99-\$499.98**

Online ID# 1878629  
**Take \$20 Off All Table Games \$199.99-\$299.98**

Online ID# 1878628



Excludes Vintage Professional Soccer, Laser Hockey, KS4000 Hockey, Black Lightning Hockey and 7' Billards Tables

**ONLINE ITEM**  
ID# 1451613

**—POWER—**  
**LIFT SYSTEM 71283 Portable Basketball System**

- 50" square acrylic backboard
- 3.5" round pole

**299<sup>98</sup>**  
Orig. 599.99  
Now 399.99

**SCHWINN**

**—FREE ASSEMBLY—**  
**Sting-Ray**

- Chopper-style bike • Custom, stretched chopper frame
- Super-wide 20"x4" slick rear tire, 24"x2" front tire

**Save \$10** **179<sup>98</sup>** Reg. 189.99

**84.98 Sale Price - 15.00 Mail-in Rebate**

**69.98 Final Cost** Reg. 99.99

**—10-MILE RANGE—**  
**Outfitter Radio Value Pack**

- Includes 2 NiMH rechargeable batteries, dual-pocket charging station and 2 headsets

If purchased separately a \$130 value

**Save \$60** After Rebate When Purchased as a Package



Shop us online at [DicksSportingGoods.com](http://DicksSportingGoods.com) or order by phone at 1.877.846.9997

# Holiday Savings on Workwear and Boots

## BOOTS

**FIELD & STREAM®**  
RUGGED BOOTS

**Thinsulate**  
INSULATION

**Men's 8" Waterproof Sport Boot**

- Nubuck leather upper
- 200g Thinsulate insulation
- Rubber lug outsole
- ✓ Double ScoreCard Points

**Wigwam 40° Below Socks...8.99**

**Save 35% OFF ORIG.**

**49<sup>98</sup>**  
Orig. 79.99  
Now 59.99



**NORTHEAST OUTFITTERS**

**Men's 6" Steel Toe Boot**

- Nubuck leather upper
- EVA midsole • Rubber lug outsole
- ✓ Double ScoreCard Points

**Save 25% OFF ORIG.**

**59<sup>99</sup>**  
Orig. 79.99



**Men's Quest Sedona Mid**

- Nubuck and suede upper
- Compression-molded EVA midsole
- Rubber lug outsole • Also available in low
- ✓ Double ScoreCard Points

**Save 33% OFF ORIG.**

**59<sup>99</sup>**  
Orig. 89.99



**—WATERPROOF/BREATHABLE—**

**Men's Gore-Tex Hiker**

- Suede leather/nylon upper
- New EVA midsole and Vibram outsole
- ✓ Double ScoreCard Points

**Save \$30 OFF ORIG.**

**69<sup>99</sup>**  
Orig. 99.99



**—STEEL TOE—**

**Men's Pro 6" Pit Boss**

- Oiled, full-grain leather upper
- Goodyear welt construction

**Save \$10 OFF ORIG.**

**89<sup>99</sup>**  
Orig. 99.99



**ROCKY®**  
STEEL AND BOOTS, INC.

**Thinsulate Ultra**  
INSULATION

**—WATERPROOF/BREATHABLE—**

**Men's Timberwolf 1000**

- 1000g Thinsulate insulation
- Vibram outsole
- Available in brown or Advantage Timber camo

**Timberwolf 2-Pack Socks 16.99**

**Save \$80 OFF ORIG.**

**119<sup>99</sup>**  
Orig. 199.99



**—WATERPROOF—**

**Men's Pac Boot**

- Molded waterproof shell • Suede leather upper • 200g Thinsulate insulation
- ✓ Double ScoreCard Points

**Save 25% OFF ORIG.**

**29<sup>99</sup>**  
Orig. 39.99



**—WATERPROOF—**

**Men's Jasper Trac**

- Seam-sealed waterproof suede leather upper
- 200g Thinsulate insulation • Polar-Trac outsole

**Save \$10 OFF ORIG.**

**49<sup>99</sup>**  
Orig. 59.99



**Men's Kananaskis**

- Waterproof rubber foot
- Waterproof leather upper
- Removable felt liner

**Save \$40 OFF ORIG.**

**59<sup>99</sup>**  
Orig. 99.99



**—DICK'S EXCLUSIVE—**

**Men's Shadow Hunter**

- Full-grain leather upper • Gore-Tex waterproof/breathable membrane • 800g Thinsulate insulation • Rubber lug outsole

**Save 50% OFF ORIG.**

**94<sup>98</sup>**  
Orig. 189.99  
Now 99.99



## WORKWEAR • RUGGED

**Carhartt**

**Jacket...69.98**  
Reg. 84.99 (Shown)

**Bib...74.98**  
Reg. 89.99 (Shown)

**ONLINE ITEM**  
ID# 1858264

**All Carhartt Jackets, Bibs and Sweat Jackets**

**Save \$15**



**NORTHEAST OUTFITTERS**

**All Northeast Outfitters Workwear and Work Accessories**

- Choose from jackets, sweat jackets, bibs, hats and gloves
- ✓ Double ScoreCard Points

**Take an Extra 20% OFF**

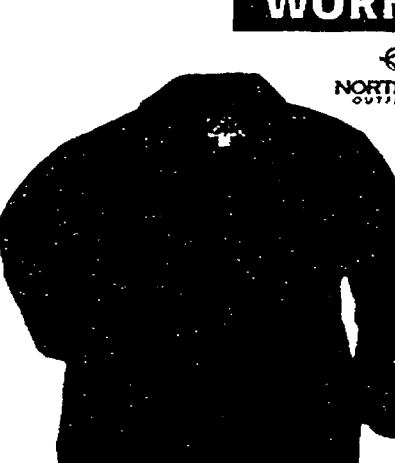

**Men's Levi's® Jeans**

- Choose from 505™, 550™, 560™ and carpenter styles in various washes
- Not available in all stores
- Orig. 34.99-40.00
- Now 29.99

**Save 30% OFF ORIG.**

**26<sup>99</sup>**



**Men's Northeast Outfitters Carpenter Jeans...24.99**  
Orig. 34.99

- Not available in all stores

**Men's Northeast Outfitters 5-Pocket Jeans**

- Choose from loose, classic or relaxed fit jeans
- Not available in all stores
- Orig. 24.99 each
- Now 19.98 each
- ✓ Double ScoreCard Points

**Save 40% OFF ORIG.**

**2 for \$30**

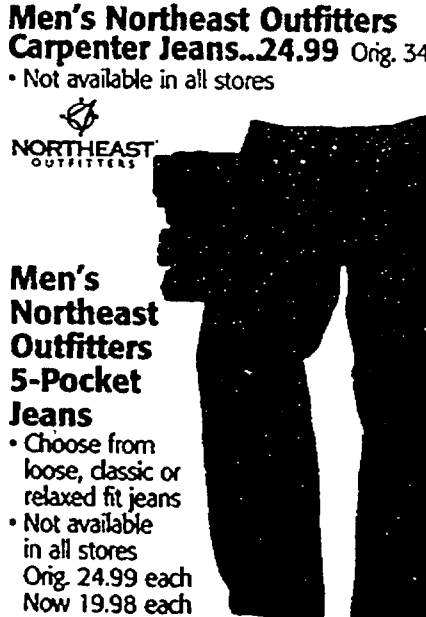

**NORTHEAST OUTFITTERS**

**Men's Northeast Outfitters Basic Flannels**

- Available in a variety of plaids
- Men's Tall sizes available
- Reg. 16.99-19.99 each
- ✓ Double ScoreCard Points

**Save 50% OFF ORIG.**

**2 for \$20**



✓ Double ScoreCard Points not available in all locations

**DICK'S**  
SPORTING GOODS

Shop us online at [DicksSportingGoods.com](http://DicksSportingGoods.com) or order by phone at 1.877.846.9997



# The Best Brands in Outerwear for A Warm Holiday Season

## OUTERWEAR

Men's or Women's  
Fleece Vest... 24.99  
Reg. 35.00

Columbia  
Sportswear Company



Men's Steens  
Mountain or Women's  
Benton Springs Fleece

- 100% MTR fleece
- Full-zip front • Drawcord at hem

Save 25% OFF ORIG. **29.99**  
Orig. 40.00

ONLINE ITEM  
ID# 1866822

Columbia  
Sportswear Company



WATER RESISTANT  
Men's or Women's  
Falmouth Parka

- Water-resistant Bergundtal nylon outer shell
- Available in Men's Tall sizes

Save \$30 OFF ORIG. **49.99**  
Orig. 80.00

ONLINE ITEM  
ID# 85117



Women's or Men's  
Khumbu Fleece Jacket

- Midweight fleece jacket with full front zip
- Adjustable drawcord at hem

Save \$19 OFF ORIG. **79.98**  
Reg. 99.00

ONLINE ITEM  
ID# 1874345

Columbia  
Sportswear Company  
TITANIUM



WINDPROOF  
Men's XLV Soft Shell Jacket

- 4-way stretch windproof fabric
- Omni-Bloc stretch soft shell

Save \$25 OFF ORIG. **99.99**  
Orig. 125.00

ONLINE ITEM  
ID# 1472498

ONLINE ITEM  
ID# 1872891

Columbia  
Sportswear Company

WATERPROOF/  
BREATHABLE

Women's  
Misty Flip  
or Men's  
Trickster Parka

- Men's Tall sizes available at slightly higher prices

Save \$80 OFF ORIG.

**159.98**  
Orig. 240.00  
Now 169.99



WATERPROOF/BREATHABLE  
Women's or Men's Q1 Jacket

- Waterproof, breathable HydroProof outer shell
- Critically seam-sealed • Zip-out fleece liner
- ✓ Double ScoreCard Points

Save \$60 OFF ORIG. **129.98**  
Orig. 190.00  
Now 149.99

ONLINE ITEM  
ID# 1874345



INTERCHANGE SYSTEM  
Men's Bugaboo or Women's  
Bugall Parka

- Zip-out liner • Water-resistant Alpha Grid outer shell

Save \$60 OFF ORIG. **139.98**  
Orig. 200.00  
Now 149.99

ONLINE ITEM  
ID# 1874345



WATER RESISTANT  
Boys' White Point Parka

- Water-resistant Square Rip outer shell with FahrenHot insulation

Save \$30 OFF ORIG. **69.99**  
Orig. 100.00

ONLINE ITEM  
ID# 1453859



WATERPROOF/BREATHABLE  
Girls' or Boys' Q1 Jacket

- Waterproof, breathable outer shell
- Critically seam-sealed • Zip-out liner
- ✓ Double ScoreCard Points

Save \$35 OFF ORIG. **89.99**  
Orig. 125.00

ONLINE ITEM  
ID# 1874345

DICK'S  
EXCLUSIVE  
Women's  
or Men's  
Scope  
Acclimate  
Parka

- Waterproof, breathable HyVent outer shell
- Zip-out liner

Save \$49 OFF ORIG.

**179.98**  
Orig. 229.00  
Now 189.99



## ACCESSORIES

SCOTT

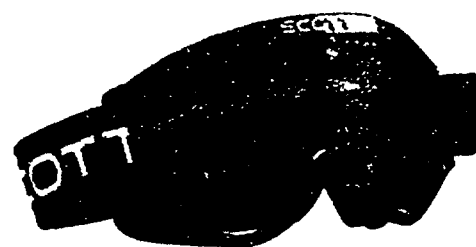

Classic Goggle

- Ventilation system, dual lens, plush E150 face foam, G-7 Spectrathane engineered frame compound

Save 20% **19.98**  
Reg. 24.99

MEDALIST



Men's or Women's  
Polypropylene/Wool  
Crew or Pants

- Merino/wool outer layer • Inner layer wicks away moisture • Big and Tall sizes available at a slightly higher price

Great Value **17.99**



Youth  
14.99

180's

Adult Ear Warmers

- Available in a variety of styles for various outdoor activities

Great Value **19.99**

ONLINE ITEM  
ID# 1874341



Men's, Women's and  
Kids' Insulated Ski Gloves

- Waterproof, breathable glove
- Insulated for warmth • Sizes S-XL

Save 20% **9.98**  
Reg. 12.99

Columbia  
Sportswear Company

Women's  
or Men's  
Columbia  
Ski Pants

- Water-resistant shell pants
- Zap fleece in seat of pants and knees

Sale  
59.99-99.99  
Orig. 80.00-125.00

Save Up To **25%\*** OFF ORIG.  
ONLINE ITEM  
ID# 1878592

**25%\*** Kids' Columbia Ski B...  
29.99-44.99 Orig. 40.00-60.00  
Online ID# 1878592

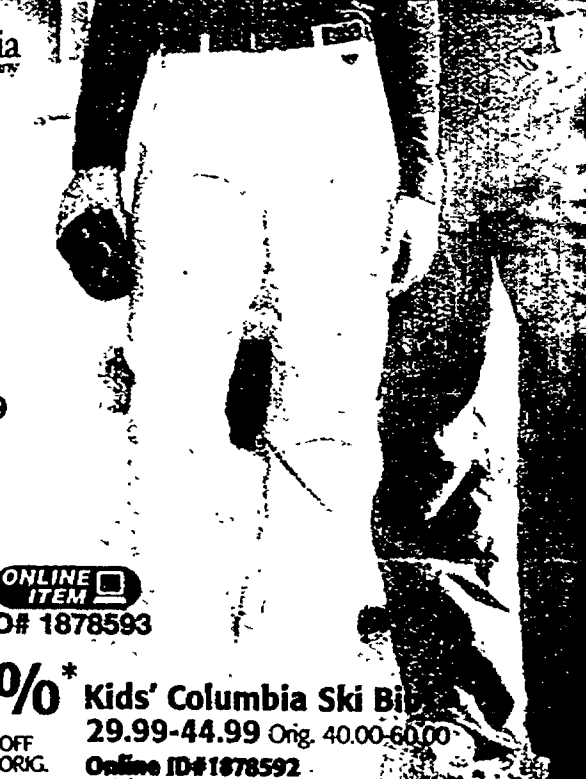

The Gift that Always Fits Purchase and redeem in-store or online.

\*Interim markdowns may have been taken

DICK'S  
SPORTING GOODS

# Huge Holiday Selection of Men's, Women's and Kids' Apparel

As we convert our merchandise selection in former Galyans' locations, there may be instances where we need to substitute advertised items.

**ATHLETIC APPAREL**

Save 20%  
On Nike and adidas  
Caps and Knit Caps  
ONLINE ITEM ID# 187511

ONLINE ITEM ID# 1878598

Entire Stock of Men's and Women's Fleece  
Choose from hoodies, pullovers and pants in basic and fashion colors  
Sizes S-XXL  
Sale 14.98-52.48  
Reg. 19.99-70.00

**Save 25%\***

ONLINE ITEM ID# 1884206

Entire Stock of Boys' and Girls' Fleece  
Choose from hoodies, pullovers and pants in basic and fashion colors  
Sizes XS-XL  
Girls' available in select stores  
Sale 12.99-29.99  
Reg. 19.99-45.00

**Save 33%\***

Women's Champion and Moving Comfort Jogbras  
Moving Comfort available in select stores  
Sale 20.98-29.98  
Reg. 27.99-39.99

**Save 25%\***

Entire Stock of Women's Ativa Apparel  
Choose from oversized hoodies, zip mocks, pants, tights, tops, bras, tanks and more  
Sizes XS-XL Reg. 16.99-39.99 each  
✓ Double ScoreCard Points

**Buy One Get One 50% OFF†**

Entire Stock of Women's adidas and New Balance Running Apparel and Bodywear  
Sale 14.98-41.18  
Reg. 19.99-55.00

**Save 25%\***

Kids' Russell or Fitness Gear Pants  
Fitness Gear pants feature elastic waist, internal drawstring, on-seam pockets and ankle zip  
Russell available in assorted fabrics and colors • Sizes XS-XL

**Save 60% OFF** 9.99  
Orig. 24.99

Kids' Fitness Gear and Ativa Fleece  
Choose from vests, jackets, hoods and pants  
Assorted colors • Sizes XS-XL  
Reg. 19.99-24.99 each  
✓ Double ScoreCard Points

**Buy One Get One FREE†**

Boys' Nike Polyfil Jacket  
Nylon outer shell  
Insulated for warmth

**Save 33% OFF ORIG.** 49.98  
Orig. 75.00

**CASUAL APPAREL**

ONLINE ITEM ID# 1831420

Columbia Sportswear Company  
Women's and Kids' Columbia Casual Apparel  
Choose from pants, tees, sweaters, mocknecks, hoodies • Sizes S-XL  
Available in select stores  
Sale 13.48-39.99  
Orig. 18.00-55.00

**Save 25%\*** OFF ORIG.

ONLINE ITEM ID# 1831420

Columbia Sportswear Company  
Men's Columbia Casual Apparel  
Choose from pants, sweaters, knits, wovens, fleece and hoodies  
Excludes GRT apparel  
Sale 12.99-39.99  
Orig. 18.00-55.00

**Save 25%\*** OFF ORIG.

✓ Double ScoreCard Points not available in all locations

# Great Gifts from the Best Brands

**UNDER ARMOUR**

**allseasongear™**  
Cold Gear's two-sided fabric construction helps maintain your body's natural heat to keep you warm without weighing you down with extra layers.

**turfgear™**  
Turf Gear's reinforced construction protects you from artificial turf damage, while it's second-skin fit wicks away moisture and helps regulate body temperature in extremely warm weather.

**allseasongear™**  
All Season Gear features a unique blend of Moisture Transport and temperature control, which allows the fabric to flex between the heat of the field and the coolness of the sidelines.

**loosegear™**  **ID# 1156997**

**Men's Cold Gear Mockneck**  
49.99  
Online ID# 1737066

**Women's Cold Gear Mockneck**  
49.99  
Online ID# 1737066

**NEW ARRIVAL**  
**Men's All Season Gear Microfleece Crew or Pant**  
59.99  
Online ID# 1594416

**Men's Turf Gear Long-Sleeve Turf Shirt**  
34.99  
Online ID# 525457

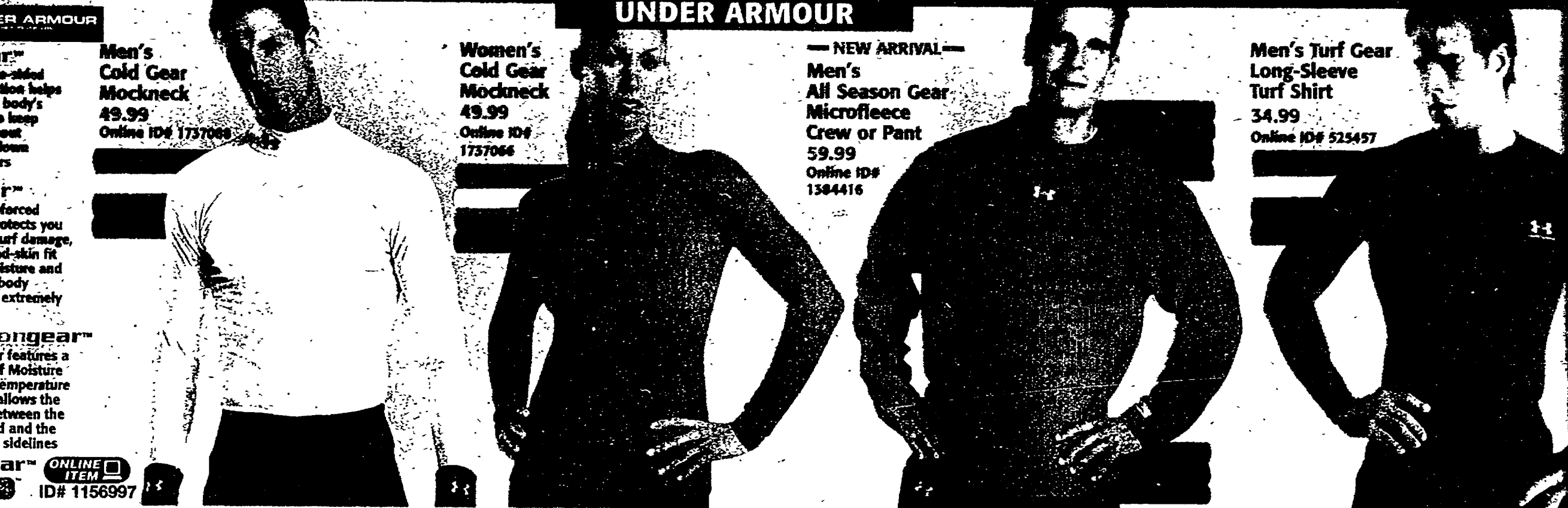

**MEN'S ATHLETIC**

**Men's Nike Pro Compression Performance Apparel**  
• Short-sleeve, long-sleeve and sleeveless tops, shorts, and leggings.  
Reg. 35.00-45.00

**Men's Nike Dri-FIT Performance Apparel**  
• Choose from long-sleeve, short-sleeve, and sleeveless top styles, as well as shorts and pants.  
Reg. 25.00-60.00

**Men's Fitness Gear and New Balance Running Apparel**  
Sale 12.98-35.98  
Reg. 19.99-59.99

**Men's adidas Galaxy Running Apparel**  
• Choose from short-sleeve and long-sleeve tops, shorts and pants.  
Sale 17.98-32.98  
Reg. 25.00-45.00

**Men's Nike or adidas Novelty Pants**  
• Feature mesh fabrication and embroidered logos.

**Men's Nike Speed Jacket**  
• Nylon outer shell  
• Insulated for warmth.

**Men's Russell Sweatless Sweats**  
• Sweatless technology wicks away moisture from skin for better performance.

**Men's Nike or adidas Basic Fleece Hoods or Pants**  
• Available in a variety of colors.

**Tech Wear**  **NIKE PRO**

**Tech Wear** 

**Save 33%\***  **ID# 1862173**

**Save 25%\*** 

**Save 29.98** Reg. 35.00

**Great Value 79.99**

**Save 25%\***

**Save Up to 33% 29.98** Reg. 40.00-45.00



**WINDWEAR**

**Entire Stock of Men's and Women's Windwear and Warmups**  
Choose from jackets and pants in various fabrications and colors.  
Save 25% on Nike, adidas and New Balance  
Includes Nike Dri-FIT  
Sale 18.98-59.98  
Reg. 26.00-85.00  
Save 50% on Fitness Gear and Ativa  
Sale 11.98-19.98  
Reg. 19.99-39.99

**Entire Stock of Boys' and Girls' Windwear**  
• Choose from jackets and pants in various fabrications and colors.  
Save 25% on Nike and adidas  
Sale 21.98-27.98  
Reg. 30.00-39.98  
Save 50% on Fitness Gear  
Sale 12.98-19.98  
Reg. 24.99-39.98

**Save 25% to 50%\***

**Save 25% to 50%\***  **ID# 1878617**



✓ Double ScoreCard Points not available in all locations

The Perfect Gift for the Holidays



\*Internet markdowns may have been taken





ONLINE ITEM ID# 710956

# FREE OR REDUCED SHIPPING ON SELECT FITNESS EQUIPMENT

www.DicksSportingGoods.com

Offer good through 12/03/04

Some exclusions apply. See web site for details.

## FITNESS

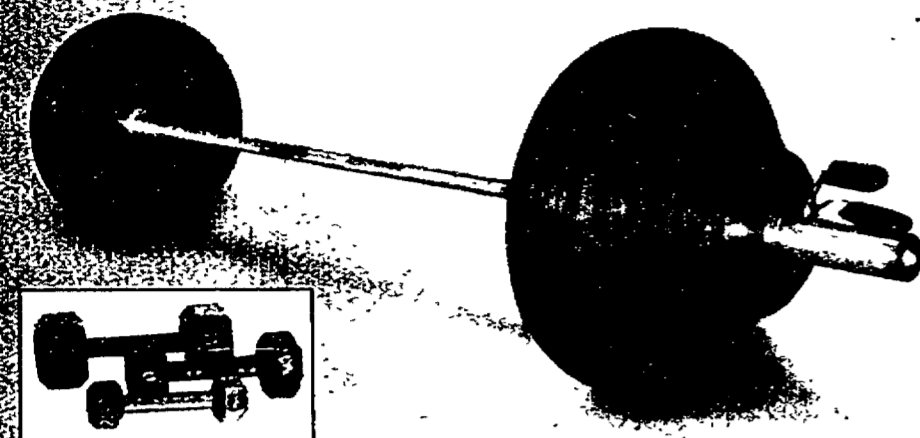

### WEIGHT SET SALE

**300 lb. Olympic Weight Set** (Shown) ..... **109.98** Reg. 149.99  
 ✓ Double ScoreCard Points Online ID# 1125026

**100 lb. Standard Weight Set** ..... **49.98** Reg. 59.99

**Olympic Plate Tree** ..... **39.98** Reg. 49.99  
 Online ID# 1386678

**Hex Dumbbells** (Shown) and **Cast Iron Plates**... **49¢/lb.** Reg. 59¢/lb.  
 • Plates sold in same-pound pairs

**40 lb. Adjustable Dumbbell Set** ..... **39.98**  
 Reg. 44.99 Online ID# 1344901

**30 lb. Chrome Dumbbell Set** ..... **39.98**  
 Reg. 44.99

**20 lb. Fitbell Set** ..... **24.98**  
 Reg. 29.99  
 ✓ Double ScoreCard Points

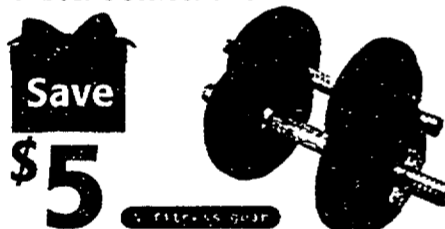

Save \$5

### All Weight Storage Racks

• Weights sold separately  
**Sale 19.98-79.98**  
 Reg. 24.99-99.99



Save 20% ONLINE ITEM ID# 1866039



**80 lb. Neva Tear Bag** **59.98**  
 Reg. 79.99 Online ID# 692900  
 Speed bag sold separately

HEAVY-DUTY STEEL  
**Heavy-Bag Stand** ONLINE ITEM ID# 1265069  
 • Heavy-duty stand with durable steel construction  
 • Adjustable speed-bag platform  
 ✓ Double ScoreCard Points

Save 50% OFF ORIG. **99.98**  
 Orig. 199.99 Now 129.99



LIFETIME GUARANTEE  
**Wavemaster**  
 • Portable, freestanding training bag  
 • Water-filled base

Includes Free instructional DVD a \$19.95 value

Great Gift **99.99**

**Utility Bench**  
 • Compact design  
 • Flat and multi-position decline positions  
 ✓ Double ScoreCard Points

Save \$10 **49.98**  
 Reg. 59.99

Save 50% OFF ORIG.

POWERHOUSE  
 —DUAL STATION—  
**GS-9 Home Gym**  
 • Two 200 lb. Quiet Iron weight stacks  
 • Military, bench and leg press  
 • Adjustable butterfly  
 • Curl bar

Save \$500 OFF ORIG. **499.98**  
 Orig. 999.99 Now 599.99  
 24 sq. ft. **Floorguard**... **49.99**  
 Online ID# 1257862

—FREE-MOTION BUTTERFLY—  
**PHE2000 Home Gym**  
 • Upper/mid/low pulleys and leg developer  
 • Adjustable backrest and press/row

Save 50% OFF ORIG. **299.98**  
 Orig. 599.99 Now 349.99  
 ONLINE ITEM ID# 1845978

—COMMERCIAL-GRADE CONSTRUCTION—  
**Ultimate Home Gym**  
 • 200 lb. weight stack  
 • Press/row  
 • Upper/mid pulleys  
 • Multi-position side pulley  
 • Available in select stores  
 ✓ Double ScoreCard Points

Save \$700 OFF ORIG. **799.98**  
 Orig. 1499.99 Now 899.99

—REMOVABLE BENCH—  
**Power 9 Olympic Bench/Rack System**  
 • Multi-position bar rests for bench, military, squat exercises  
 • Walk-in squat, lat bar and leg developer

Save \$100 OFF ORIG. **199.98**  
 Orig. 299.99 Now 229.99  
 ONLINE ITEM ID# 1390255

—MULTI-POSITION INCLINE—  
**PHC 1955 Olympic Bench**  
 • Olympic-width uprights  
 • Flat and multi-position incline backrest  
 • Dip station, walk-in squat and leg developer

Save \$80 OFF ORIG. **169.98**  
 Orig. 249.99 Now 189.99  
 ONLINE ITEM ID# 1383558

—REMOVABLE BENCH—  
**PHE9000 Smith/Rack**  
 • Smith/rack, pec deck, dual upper pulleys, lower pulley, arm curl, leg developer  
 ✓ Double ScoreCard Points

Save 50% OFF ORIG. **399.98**  
 Orig. 799.99 Now 499.99  
 ONLINE ITEM ID# 1845980

—MULTI-FUNCTION—  
**FG800 Deluxe Power Tower**  
 • Multi-station  
 • Use your own body weight to perform multiple strength exercises  
 ✓ Double ScoreCard Points

Save \$30 OFF ORIG. **99.99**  
 Orig. 129.99

ONLINE ITEM ID# 1828143



Save 50% OFF ORIG.

### —SPECIAL PURCHASE— CSE2 Elliptical

• Club-style design provides smooth elliptical motion  
 • 22 lb. flywheel is one of the heaviest in its class  
 • SCM Resistance System is quiet and friction-free for easy adjustment of 15 resistance levels

Save \$600 OFF ORIG. **599.98**  
 Orig. 1199.99 Now 699.99



Take 10% Off Polar Heart Rate Monitors  
 Online ID# 1894267

—LOW-IMPACT WORKOUT—  
**800 Elliptical**  
 • Electromagnetic resistance  
 • 2-window, 5-display console  
 • Reflex step  
 • EKG pulse sensor  
 • Cooling fans

Save \$100 OFF ORIG. **399.99**  
 Orig. 499.99  
 PRO-FORM ONLINE ITEM ID# 1395337

—8 PROGRAMS—  
**RL 545 Elliptical**  
 • Motorized resistance  
 • 8 programs with 2 heart rate-driven programs  
 • 250 lb. capacity  
 • 90-day warranty

Save \$300 OFF ORIG. **499.98**  
 Orig. 799.99 Now 599.99  
 REEBOK ONLINE ITEM ID# 1271287

—8 RESISTANCE LEVELS—  
**Edge 327 Upright Bike**  
 • Target Zone training with 6 programs  
 • Adjustable tension control • Built-in hand-pulse heart-rate sensors

Save \$50 OFF ORIG. **199.99**  
 Orig. 249.99  
 FitnessQuest ONLINE ITEM ID# 1411648

—8 RESISTANCE LEVELS—  
**Edge 491PR Recumbent Bike**  
 • 12 programs including 2 heart rate-driven programs

Save \$50 OFF ORIG. **349.99**  
 Orig. 399.99  
 FitnessQuest ONLINE ITEM ID# 1138419

—OVER 60 GYM-QUALITY EXERCISES—  
**Bowflex Sport**  
 • 5 lb.-210 lb. resistance upgradeable to 410 lb.  
 • Built-in squat platform and pulleys • No-time-limit warranty on bows

Save \$200 OFF ORIG. **799.99**  
 Orig. 999.99  
 BOWFLEX ONLINE ITEM ID# 1747525

—TOTAL-BODY WORKOUT—  
**Total Gym 1700 Club**  
 • Includes exercise mat, dip and press bars, Pilates bar and weight bars

Save \$50 OFF ORIG. **349.99**  
 Orig. 399.99  
 Endorsed by Chuck Norris & Christie Brinkley  
 ONLINE ITEM ID# 1733357

✓ Double ScoreCard Points not available in all locations



For the store location nearest you, please call 1.866.819.0038

# Great Gifts to Keep You Moving

## FITNESS

**SmartBoard console**

**Quiet Drive Motor**

**WARRANTY**  
12-Year Motor  
1-Year Parts  
90-Day Labor

**DICK'S EXCLUSIVE**  
**CST3 Treadmill**  
2hp continuous-duty  
Quiet Drive motor  
Comfort Zone belt  
and deck system  
SmartBoard  
electronic console  
Folds for easy storage

**ONLINE ITEM**  
ID# 1828138

**Save \$200 OFF ORIG.** **799<sup>98</sup>** Orig. 999.99  
Now 899.99

**Treadmill Mat...29.99**  
Online ID# 1186071

**330i Treadmill**  
2.25hp  
Mach motor  
0-10mph • 0-10% incline  
18"x45" treadbelt  
Cushioned deck  
Grip heart-rate monitor  
Cooling fan

**WARRANTY**  
Lifetime Frame  
3-Year Motor  
90-Day Parts  
and Labor

**Save \$100 OFF ORIG.** **399<sup>99</sup>** Orig. 499.99

**PRO-FORM**  
**ONLINE ITEM**  
ID# 1863081

**SPECIAL PURCHASE**  
**T-25 Treadmill**  
1.75hp continuous-duty motor  
0-10mph, 0-10% incline • 20"x55" treadbelt  
4-window LED console

**WARRANTY**  
Lifetime Frame  
10-Year Motor  
1-Year Parts  
90-Day Labor

**Save 50% OFF ORIG.** **599<sup>98</sup>** Orig. 1199.99  
Now 699.99

**ONLINE ITEM**  
ID# 1828141

**T-35 Treadmill**  
2hp continuous-duty motor  
0-10mph, 10% incline  
20"x55" deck  
10 pre-set programs  
EKG heart-rate monitor

**WARRANTY**  
Lifetime Frame  
10-Year Motor  
1-Year Parts  
90-Day Labor

**Save 50% OFF ORIG.** **699<sup>98</sup>** Orig. 1399.99  
Now 799.99

**ONLINE ITEM**  
ID# 1828142

**DICK'S EXCLUSIVE**  
**CST4 Treadmill**  
2.25hp continuous-duty  
Quiet Drive motor  
0-12mph, 0-12% incline  
20"x55" treadbelt  
SmartBoard console with 8 programs

**WARRANTY**  
15-Year Motor  
1-Year Parts  
and Labor

**Save \$300 OFF ORIG.** **999<sup>98</sup>** Orig. 1299.99  
Now 1099.99

**ONLINE ITEM**  
ID# 1828139

**LOW IMPACT**  
**Gazelle Freestyle**  
Aerobic exercise and resistance training in one easy workout  
Complete range of motion

Endorsed by Tony Little

**Save \$30 OFF ORIG.** **199<sup>99</sup>** Orig. 229.99

**FitnessQuest**  
**ONLINE ITEM**  
ID# 841755

**FOLDS EASY FOR STORAGE**  
**Ab Lounge 2**  
Works upper and lower abs  
Supports head, neck and back through entire exercise  
Rolled steel frame  
Supports up to 250 lb.

**Great Gift**

**99<sup>99</sup>**

**ONLINE ITEM**  
ID# 1739198

## ATHLETIC FOOTWEAR

**A. Men's NT Ultra**  
Basketball shoe • Full-grain leather upper  
Compression-molded EVA midsole  
Non-marking rubber outsole  
Orig. 59.99 Now 49.99

**B. Women's T-Lite II**  
Trainer • Synthetic leather upper  
Full-length Phylon midsole  
Solid rubber outsole  
Reg. 49.99

**Save Up To 33% OFF ORIG.** **39<sup>98</sup>**

**adidas** **NIKE**

**A. Men's Air Max Assail**  
Running shoe • Breathable mesh upper  
PU/Phylon midsole • BRS 1000 waffle design outsole  
Orig. 74.99 Now 64.99

**B. Women's Response Trail**  
Trail running shoe  
Synthetic leather and mesh upper  
Discontinued style  
Orig. 79.99 Now 59.99

**ONLINE ITEM**  
ID# 137250

**Save Up To 35% OFF ORIG.** **49<sup>98</sup>**

**NIKE** **adidas**

**Your Choice**

**Save Up To 33% OFF ORIG.** **39<sup>98</sup>**

**adidas** **NIKE**

**Your Choice**

**Save Up To 35% OFF ORIG.** **49<sup>98</sup>**

**NIKE** **adidas**

**Men's Air Monarch II**  
Trainer • Available in wide widths  
Also available in black in select stores

**Save \$10 OFF ORIG.** **49<sup>98</sup>** Reg. 59.99

**ONLINE ITEM**  
ID# 1876056

**Kids' Flight Hops**  
Basketball shoe  
Leather upper  
Speed lacing system

**Save 20% OFF ORIG.** **34<sup>99</sup>** Orig. 44.99

**NIKE**

**Men's Attest**  
Running shoe  
Breathable mesh upper

**Save 20% OFF ORIG.** **39<sup>98</sup>** Reg. 49.99

**NIKE**

**Women's or Men's Gel So**  
Running shoe  
Available in wide widths

**Save 20% OFF ORIG.** **49<sup>98</sup>** Orig. 64.99  
Nov 54.99

**asics**

**Men's Uprise**  
Basketball shoe  
Synthetic upper

**Save \$10 OFF ORIG.** **74<sup>98</sup>** Reg. 84.99

**ONLINE ITEM**  
ID# 1876057

**Men's Shox Elevate**  
Basketball shoe  
Color selection varies by store

**99<sup>99</sup>**

**NIKE**

**Women's Shox Bella**  
Running shoe  
Color selection varies by store

**99<sup>99</sup>**

**NIKE**

**Men's or Women's Shox 2:45**  
Running shoe  
Color selection varies by store

**109<sup>99</sup>**

**NIKE**

## IN-LINE

In-line skates available in select stores

**Launch Ramp Set**  
Contains two launch ramps and a table top connecting module  
Build your own skate park for in-line, bikes and skateboards

**Save \$20 OFF ORIG.** **79<sup>99</sup>** Orig. 99.99

**TEN EIGHTY**

**Youth Twist**  
Expandable skate adjusts 4 sizes

**Save 33% OFF ORIG.** **39<sup>99</sup>** Orig. 59.99

**NEW COLOR FOR 2005**

**ONLINE ITEM**  
ID# 1822213

**EXPANDABLE**  
**ROLLERBLADE**

**Youth Skate Attack Xpander Combo**  
Skate adjusts 4 sizes  
Skate bag, knee, elbow and wrist guards

**Save 50% OFF ORIG.** **39<sup>99</sup>** Orig. 79.99

**ULTRA**

**Prowler**  
2-piece boot structure  
ABEC-5 bearings  
76mm wheels  
Double ScoreCard Points

**Save 50% OFF ORIG.** **39<sup>98</sup>** Orig. 79.99  
Now 49.99

**10 FEET**



The Perfect Fit for Business Gifts or Fundraising



See store for details or call our Gift Card Specialist at 1.800.690.7655 x3819

✓ Double ScoreCard Points not available in all locations



## GAMES

Table game selection varies by store

Check Out Our  
Department of Air  
Hockey Pushers  
and Pucks

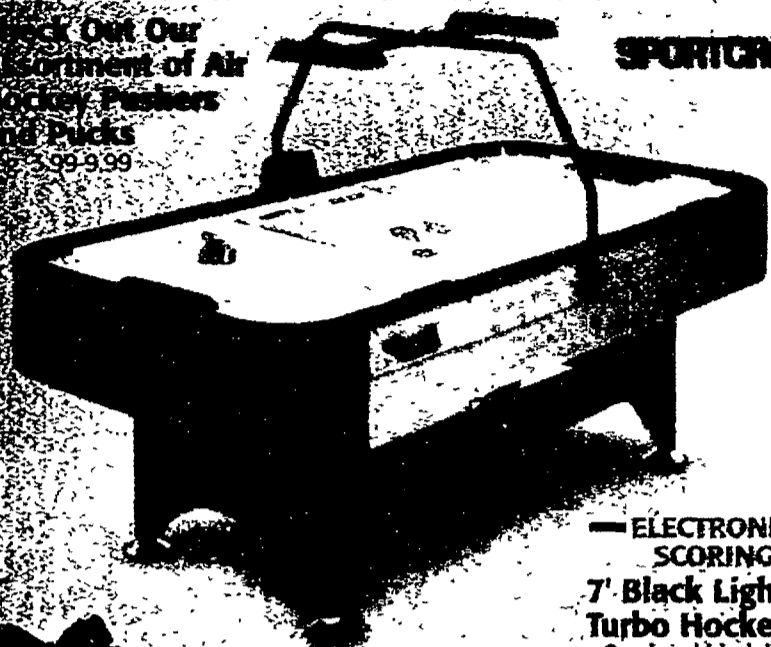

**SPORTCRAFT**

Save \$200 OFF ORIG. **299.98**  
Orig. 499.99  
Now 349.99

**ELECTRONIC SCORING**  
**7' Black Lightning Turbo Hockey Table**  
• Overhead black lights  
• Aluminum inner rail  
• Electronic scoring  
• Routed playfield  
• 84"x44"x31" • #34040

**LIGHT AND SOUND EFFECTS**  
**KS4000 Turbo Hockey Table**

• Overhead scoring with sound effects and black-light feature  
• Lights in goals and inner rails  
• 96"x49.5"x32.5" • #34042

**SPORTCRAFT**

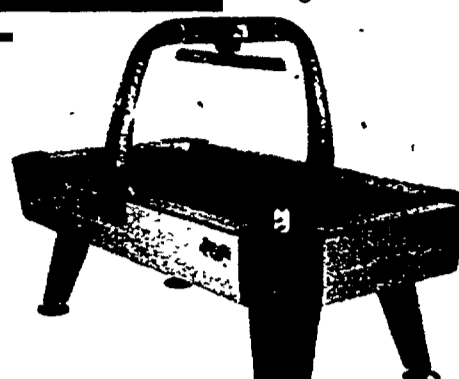

Save \$100 OFF ORIG. **699.99**  
Orig. 799.99

**NEW AND IMPROVED**  
**Vintage Soccer II Table**

• Easy to assemble  
• Ball bearings for smoother spin and faster shots  
• Solid oak finish  
• 56.25"x30.88"x34"  
• #TBL00011

**HG**

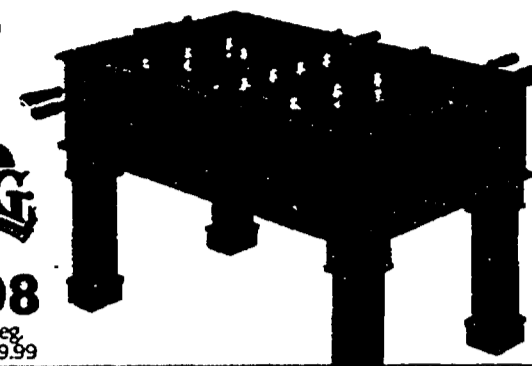

Save \$50 **349.98**  
Reg. 399.99

**CONVERTS EASILY**  
**8' Laser Hockey/ Table Tennis Table**

• 8' air-powered turbo hockey table converts to regulation 5'x9' table tennis table  
• Electronic hockey scoring with sound effects • 2 motors • #36014

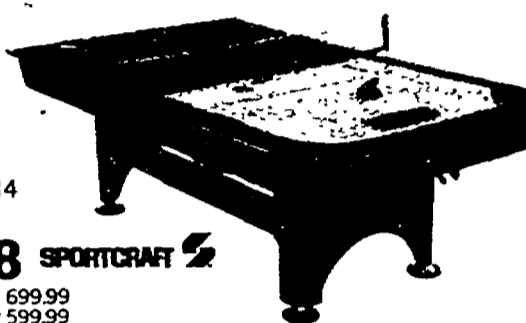

Save \$200 OFF ORIG. **499.98** **SPORTCRAFT**  
Orig. 699.99  
Now 599.99

**NEW AND IMPROVED**  
**Professional Soccer Table**

• Ball bearings offer smooth spin and continuous action  
• 54"x30"x34" • #TBL00010

**HG**



Save \$50 **249.98**  
Reg. 299.99

## SAVE ON TABLE TENNIS TABLES

Save \$100 • Marquis ..... **399.98** Reg. 499.99

Save \$150 • Power Serve ..... **349.99** Orig. 499.99

Save \$25 • QuickPlay ..... **174.98** Reg. 199.99

Save \$50 • Classic Series ..... **99.98** Orig. 149.99 Now 129.99

**ZIGA**

**SPORTCRAFT**



**NEW AND IMPROVED**  
**Bank Shot**

• 2-player option for one-on-one play  
• Electronic timing and scoring  
• 84"x84"x43"  
• #27095

**ONLINE ITEM**  
ID# 1887021



Save \$80 OFF ORIG. **119.99**  
Orig. 199.99

**7 GAMES IN 1**  
**Multi-Game**

• Features foosball, turbo hockey, bowling, shuffleboard, checkers, backgammon and chess  
• 47"x23.5"x32.75"  
• No rainchecks • #36041

**SPORTCRAFT**



Save \$80 OFF ORIG. **119.99**  
Orig. 199.99

**Bocce Set (Shown)**  
— OR —  
**Horseshoe Set**  
Online ID# 1229823



Your Choice  
Save \$10 **59.98**  
Reg. 69.99

**SPORTCRAFT**

**FEATURES 28 GAMES**  
**Aurora Electronic Dartboard**

• 8-player scoring  
• 167 total variations  
• Includes 12 darts

**HG**

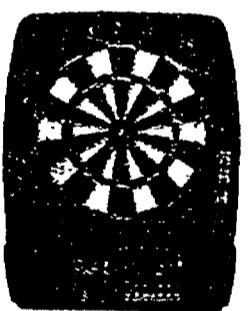

Save \$50 OFF ORIG. **49.98**  
Orig. 99.99  
Now 59.99

**Bristle Dartboard with Cabinet**

• Regulation-size dartboard  
• Self-healing bristle-fiber construction  
• Internal dart-storage shelves

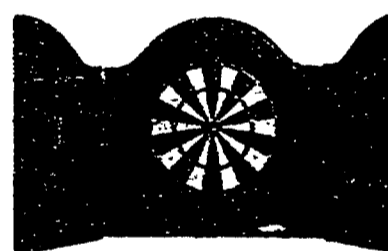

Save \$10 **59.98**  
Reg. 69.99

**HG**

**Madison Bristletech Dartboard**

• Exclusive Bristletech target allows play with steel-tip or soft-tip darts

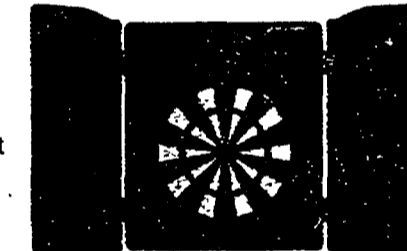

Save \$10 **89.98**  
Reg. 99.99

**Harco**



**Pool Cue with Case**  
**19.98** Reg. 24.99

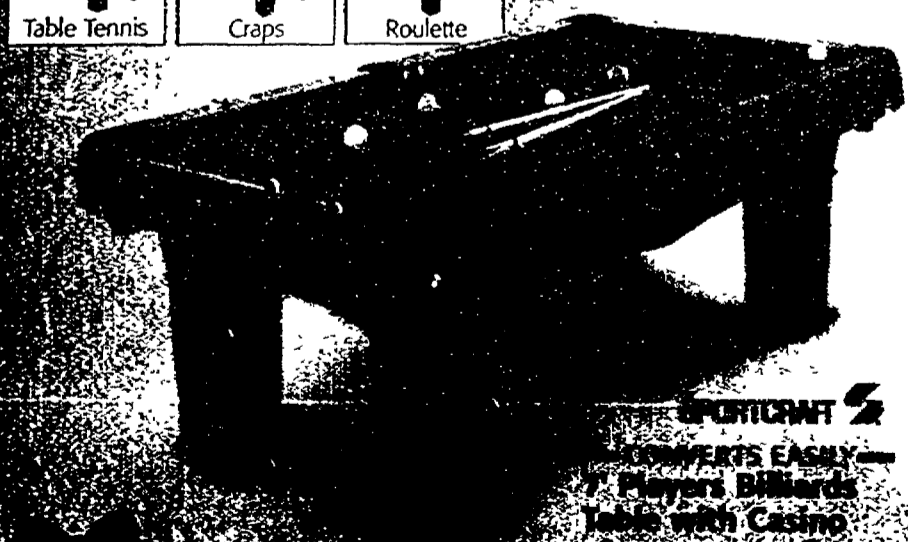

**SPORTCRAFT**  
**CONVERTS EASILY**  
**Players Billiards Table with Casino**  
Converts easily for billiards, table tennis, roulette or craps  
• Regulation 5'x9' table tennis top  
• Embossed drop pockets  
• Includes game accessories

Save \$100 OFF ORIG. **499.99**  
Orig. 599.99

**Executive Poker Set**

• Includes 300 professional-size chips  
• Aluminum finish case with security lock and lined interior  
• Play book • #60616Z

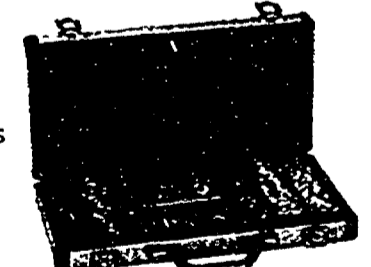

Save \$20 **79.98**  
Reg. 99.99 **ONLINE ITEM**  
ID# 1876696

**Deluxe Poker Set**

• Metal, velvet-lined case with locks  
• 300 casino-style poker chips  
• 2 casino-quality poker decks  
• #ALM300 or #GMT-12018



Save 20% **39.98**  
Reg. 49.99 **ONLINE ITEM**  
ID# 1876695

**Texas Hold 'em Poker Set**

• Includes playing cards, 100 poker chips, felt mat, dealer button and instructions for tournament and family-style play

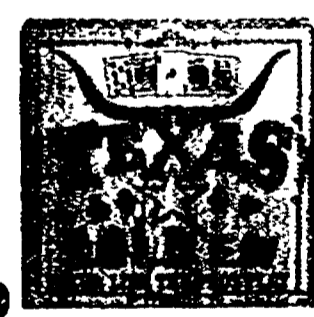

Great Gift **14.99**

**Entire Stock of Men's and Women's Bowling Shoes**  
Sale **23.98-31.98**  
Orig. 39.99-49.99  
Now 29.99-39.99



Save Up To **40%** OFF ORIG.

✓ Double ScoreCard Points not available in all locations

## BOWLING

**Entire Stock of Bowling Bags**

• Choose from single-ball, double-ball, roller bags and more  
Sale **11.98-47.98**  
Reg. 14.99-59.99



Take **20% OFF** **ONLINE ITEM**  
ID# 1870054

**Brunswick's BONE**  
**Polyester Bowling Ball**

• Choosing from several styles and colors  
• Available in 6, 8, 10, 12 and 14 lb.

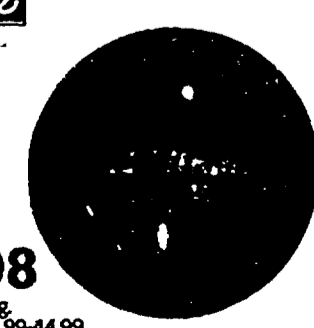

Save Up To **20%** **34.98**  
Reg. 39.99-44.99

**DICK'S**  
SPORTING GOODS

Shop us online at [DicksSportingGoods.com](http://DicksSportingGoods.com) or order by phone at 1.877.846.9997



# Holiday Savings on Winter Sports and Paintball

## SCOOTERS • SNOWBOARDS • HOCKEY

— 180 LB. CAPACITY —

### Ion 150 Electric Scooter

- 150W motor
- 5-hour charge time
- Speeds up to 12mph

Save 50% Off Orig. After Rebate

**129.98 Sale Price**  
- 30.00 Mail-in Rebate  
**99.98 Final Cost**  
Orig. 199.99 Now 149.99



ONLINE ITEM  
ID# 1879601

— JR. SNOWBOARD —

### Youth Tagger Jr. Snowboard Package

- Includes Tagger snowboard, Force boots and MX-1 binding

**199.98**

Save \$40 When Purchased as a Package

If purchased separately a \$239.99 value



Lamar

### Men's Mission Snowboard Package

- Includes Mission snowboard, Justice boots and MX-5 binding

**249.98**

Save \$40 When Purchased as a Package

If purchased separately a \$289.99 value



Lamar

### Youth Voyager Snowboard Package...179.98

Orig. 279.99 Now 219.99



Element snowboard

### Men's Element or Women's Siren Snowboard Package

- Includes snowboard, boots and binding
- Orig. 299.99 Now 229.99
- Double ScoreCard Points

**189.98**

Save \$110 OFF ORIG.



— 275 LB. CAPACITY —

### XTR SE 450 Electric Scooter

- 450W chain-driven motor
- Speeds up to 16mph

**299.98**  
Orig. 499.99 Now 349.99

Save \$200 OFF ORIG.



### Men's Movement Snowboard Package

- Includes Movement or Stroke snowboard, Legion boots and FF2000 binding

**299.98**

Save \$40 When Purchased as a Package

If purchased separately a \$339.99 value



FF2000

### Men's Lithium Snowboard Package

- Includes Lithium snowboard, Lamar Justice boots and Dimension binding

**249.98**

Save \$40 When Purchased as a Package

If purchased separately a \$289.99 value



MORROW

### CCM Gold Medal Figure Skate

— OR —

### DBX 1100 Figure Skate

- Available in Youth, Men's and Women's

### Your Choice

Save 20% OFF ORIG.  
**19.99**  
Orig. 24.99



CCM

### All Hockey Helmets \$69.99 or more

Save \$10 OFF ORIG.



ONLINE ITEM  
ID# 1878635

### All Regular Price Hockey and Soccer Goals \$39.99 or more

Save \$10 OFF ORIG.

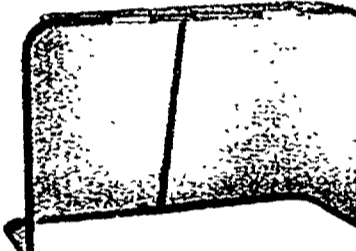

ONLINE ITEM  
ID# 1874339 POWER BOLT

### Mini Hockey Set

- Includes folding mini-hockey goal, 1 goalie and 2 player mini hockey sticks and 2 foam balls

Great Gift **29.99**



ONLINE ITEM  
ID# 1060700

### Wheeled Hockey Team Bag

- Wheeled bag with 600D polyester construction
- Skid bars and reinforced frame

Save 33% OFF ORIG.  
**59.98**  
Reg. 89.99

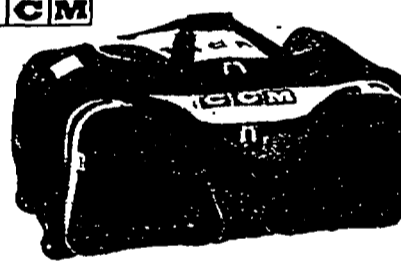

ONLINE ITEM  
ID# 1737661

### All Easton Hockey Sticks \$69.99 or more

Save \$10 OFF ORIG.

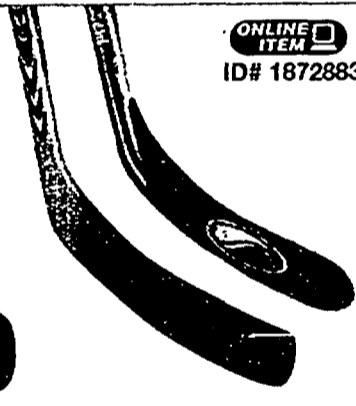

ONLINE ITEM  
ID# 1872883

### Your Choice

Save 20% OFF ORIG.  
**39.99**  
C/S 49.99



CCM  
BAUER

Men's Intruder or Silver Comp Hockey Skates  
• Extra stiffeners for ankle support  
• Sizes 6-12

### 20 oz. Aluminum Tank...29.98

Reg. 39.99  
Online ID# 1327744

spyder KING/MAIN

### Victor II

- Semi auto

Save \$30 OFF LIST  
**69.98**  
List 99.99 Now 79.99



ONLINE ITEM  
ID# 1376540

### VL Quantum Loader

29.99  
Online ID# 1450267

spyder KING/MAIN

### TLX

- Semi auto

Save \$40 OFF LIST  
**99.98**  
List 139.99 Now 119.99



ONLINE ITEM  
ID# 1800394

### 4-in-1 Deluxe Hauler...19.99

Online ID# 1827807

spyder KING/MAIN

### Rodeo

- Semi auto

Save \$20 OFF LIST  
**149.99**  
List 169.99



ONLINE ITEM  
ID# 1446600

### Replacement Barrel...39.99

Online ID# 1435680

TIPMANN

### 98 Custom

- Tournament grade

Save \$40 OFF ORIG.  
**159.98**  
Orig. 199.99 Now 179.99



ONLINE ITEM  
ID# 1304220

### Includes heavy-duty reusable paintball case - a \$9.99 value

### 1500-Count Paintballs

- .68 caliber paintballs
- Available in assorted colors
- Double ScoreCard Points

Great Gift **34.99**



ONLINE ITEM  
ID# 1883347

### 2000-Count Whack Paintballs

- .68 caliber premium paintballs
- 2-tone shell with brilliant fill
- Includes reusable bucket

Sale **39.98**  
Reg. 44.99



NELSON

✓ Double ScoreCard Points not available in all locations



ONLINE ITEM  
ID# 1732454

If purchased separately a \$150 value

1000-Count DBX Paintballs  
**19.99**  
Online ID# 1883346

Save \$50 OFF ORIG.  
**99.98**  
Reg. 119.99

— 9 oz. CO2 TANK —  
**Piranha R6 Player Pack**  
• Semi-auto Piranha R6 marker with bottom line  
• Squeegee  
• X-Ray single-lens goggle system  
• 200-round hopper with elbow

For the store location nearest you, please call 1.866.819.0038

**DICK'S**  
SPORTING GOODS

# Guaranteed Low Prices on Outdoor Gifts

## CAMPING • TECHNOLOGY

**RATED TO 15°F**  
**A. Catamount Mummy Bag**  
 • 2-layer, offset quilt construction eliminates cold spots  
 • Thermolite Quallo insulation keeps you warm even when wet  
 • Includes stuff sack

**OR**  
**RATED TO 20°F**  
**B. Adirondack Sleeping Bag**  
 • Ripstop shell and taffeta lining  
 • 2-layer, offset quilt design eliminates cold spots  
 • Thermolite Quallo insulation keeps you warm even when wet  
 • Includes stuff sack



**Save \$50 OFF ORIG.**  
**49<sup>99</sup>**  
 Orig. 99.99

**Northeast Outfitters Rectangular Fireplace... 79.98**  
 Reg. 89.99

**NORTHEAST OUTFITTERS Outdoor Fireplace**  
 • Perfect size for the backyard or campsite  
 • Heat-resistant paint  
 • Includes wheels  
 • Double ScoreCard Points



**Save \$10 OFF ORIG.**  
**49<sup>98</sup>**  
 Reg. 59.99

**Ground Mat... 29.99**

**DIGITAL CAMERA/BINOCULARS**  
**CaptureView 8x22**  
 • Full-function binoculars and 1.3 megapixel digital camera with 16MB memory  
 • Up to 60 seconds of video with internal memory or more with optional SD card (not included)  
 • Includes USB cable, CD-ROM imaging software, carry case and neck strap

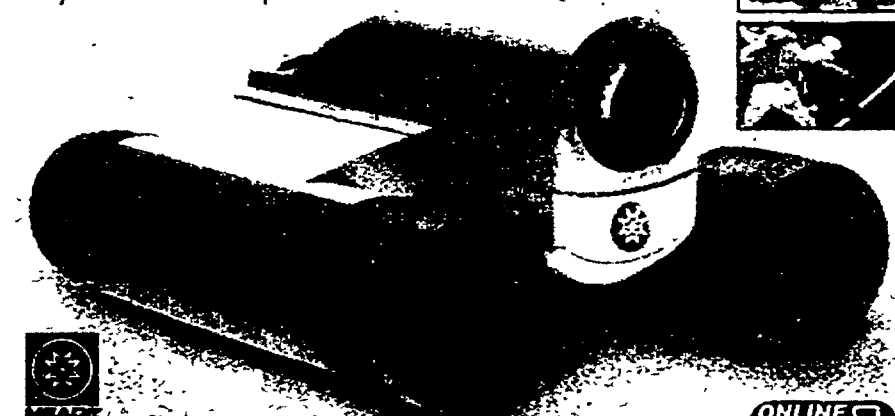

**Save \$30 OFF LIST**  
**99<sup>99</sup>**  
 List 129.99

**CaptureView 8x22 VGA 69.99** List 99.99 Online ID# 1348452

**Coleman ONLINE ITEM ID# 1770358**  
 Includes 110V air pump a \$29.99 value  
**Queen Double-High Air Bed with Pump**  
 • Inflated size 77"x61"x18"  
 • Comfortsmart coil system



**Save 25% OFF ORIG.**  
**59<sup>98</sup>**  
 Reg. 79.99

**All Quest Sleeping Bags**  
 • Choose from -25°, -10° and 0° bags  
**Sale 24.98-59.99**  
 Orig. 49.99-119.99  
 ✓ Double ScoreCard Points



**Save 50% OFF ORIG.**

**Coleman ONLINE ITEM ID# 1757610**  
**Oversized Patio Fireplace and Grill**  
 • Wood-burning fireplace and charcoal grill  
 • 24" cooking grate  
 • Weather-resistant porcelain lid



**Save \$10 OFF ORIG.**  
**89<sup>98</sup>**  
 Reg. 99.99

**MOTOROLA ONLINE ITEM ID# 1789494**  
**T5500 Radio 2-Pack**  
 • 22-channel FRS/GMRS radios  
 • 38 privacy codes

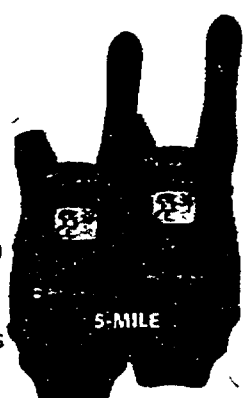

**Save 20% OFF ORIG.**  
**39<sup>98</sup>**  
 Reg. 49.99

If purchased separately a \$180 value  
**MOTOROLA ONLINE ITEM ID# 1789497**  
**T5950 NiCD Radio Value Pack**  
 • Includes 2 rechargeable batteries, charging station and 2 ear buds

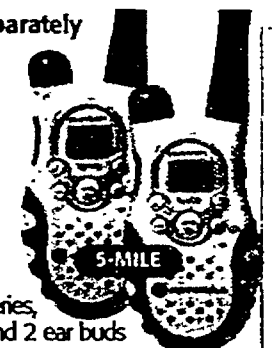

**Save \$130 After Rebate When Purchased as a Package**  
**64.98 Sale Price**  
**-15.00 Mail-in Rebate**  
**49.98 Final Cost** Reg. 89.99

**MOTOROLA ONLINE ITEM ID# 1789501**  
**T7100 NiCD Radio 2-Pack**  
 • 22-channel FRS/GMRS radios  
 • Includes 2 NiCd rechargeable batteries and charging stations



**Save \$30 After Rebate**  
**84.98 Sale Price**  
**-15.00 Mail-in Rebate**  
**69.98 Final Cost** Reg. 99.99

**Coleman**  
**RATED TO 30°F**  
**Addison Sleeping Bag**  
 • 4 lb. Thermotech fill  
 • Zip Plow eliminates zipper snags

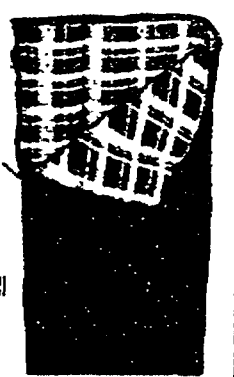

**Save 25% OFF ORIG.**  
**14<sup>98</sup>**  
 Reg. 19.99

**Coleman**  
**RATED TO -5°F**  
**Mountain Lodge Sleeping Bag**  
 • Heavy-duty 10 oz. cotton duck outer  
 • Yard-dyed cotton flannel liner  
 • 6 lb. of DuPont Holofoil 808 insulation  
 • Includes wrap and pillow



**Save \$40 OFF ORIG.**  
**59<sup>98</sup>**  
 Orig. 99.99 Now 69.99

**Eureka! All Eureka Getaway Tents Sale**  
 59.99-99.99  
 Orig. 119.99-199.99



**Save 50% OFF ORIG.**

**GARMIN WATER-RESISTANT eTrex GPS Unit**  
 • 12 parallel channels  
 • 500 waypoints with name and graphic symbol  
 • Trip computer for distance, time and speed



**Save \$20 OFF ORIG.**  
**99<sup>99</sup>**  
 Orig. 119.99

**8MB OF MEMORY**  
**SporTrak Sportsman's GPS Bundle**  
 • 12 parallel channels  
 • 500 waypoints and 20 routes  
 • 8MB of built-in maps and memory  
 • Quadriilar antenna - WAAS enabled  
 • Includes belt clip case, topographical software and PC cable

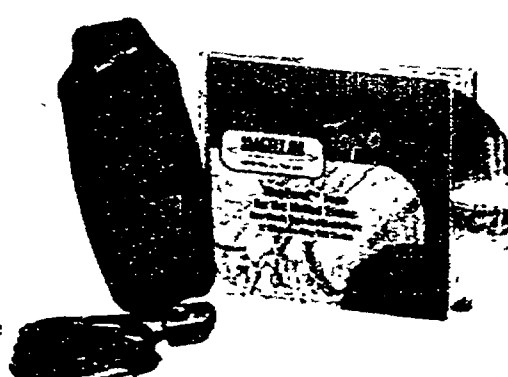

**Save \$150 After Rebates When Purchased as a Package**  
**259.99 Reg. Price**  
**-30.00 Instant Rebate**  
**-30.00 Mail-in Rebate**  
**199.99 Final Cost**

**MAGELLAN** If purchased separately a \$350 value

**4.5 gal. Peanut Oil... 24.99**  
**12-PIECE SET**  
**Deluxe Turkey Fryer**  
 • 30 qt. aluminum pot with accessories  
 ✓ Double ScoreCard Points

**Save 25% OFF ORIG.**  
**59<sup>98</sup>**  
 Reg. 79.99

**Santa Fe 4000 Internal Frame Pack**  
 • 4000 cu. in.  
 • Sliding back panel adjusts to fit most users  
 • Multiple compartments  
 • Dual-density shoulder and waist belts



**Save \$40 OFF ORIG.**  
**79<sup>98</sup>**  
 Orig. 119.99 Now 99.99

**1 lb. Propane Cylinder 1.99**  
**Portable Buddy Heater**  
 • Portable propane-powered heater  
 • Auto shut-off safety switch

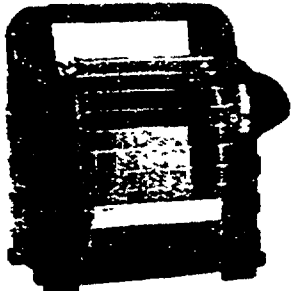

**Great Gift**  
**89<sup>99</sup>**

**SIMMONS ONLINE ITEM ID# 1382398**  
**Pro Sport 8-17x25 Compact**  
 • 8-17 power quick-focus zoom  
 • Lightweight and compact  
 • Rubber armor coating  
 • Includes carrying case and straps



**Save 50% OFF ORIG.**  
**39<sup>98</sup>**  
 List 79.99 Now 49.99

**Bushnell ONLINE ITEM ID# 1885354**  
**WATERPROOF/FOGPROOF 10x42 Scout**  
 • Superior multi-coated optics  
 • Lightweight  
 • Wide field of view  
 • Rubber armor coating



**Save \$70 OFF LIST**  
**89<sup>98</sup>**  
 List 159.99 Now 99.99

**Bushnell ONLINE ITEM ID# 501289**  
**400-YARD RANGE Yardage Pro Sport**  
 • Laser rangefinder  
 • 4-power magnification

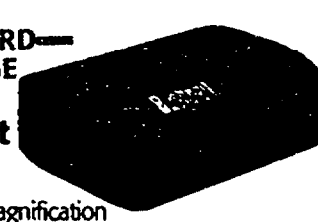

**Save \$30 OFF ORIG.**  
**149<sup>99</sup>**  
 Orig. 179.99

✓ Double ScoreCard Points not available in all locations

**DICK'S SPORTING GOODS**

Shop us online at [DicksSportingGoods.com](http://DicksSportingGoods.com) or order by phone at 1.877.846.9997

# Gifts for Your Favorite Outdoor Enthusiast

## FIREARMS

**ROSSI**

**INCLUDES BARREL —**  
**Youth Matched Pair**  
 • 22 LR/410 ga. or 22 LR/20 ga.  
 • Interchangeable barrels

**Save \$90**  
 OFF LIST  
**99<sup>98</sup>**  
 List 189.99  
 Now 139.99

**RUGER**

**10/22 Semi-Auto**  
 • 22 carbine  
 • 10-shot .22 LR rotary magazine  
 • Hardwood stock

**Save \$20**  
**149<sup>98</sup>**  
 Reg. 169.99

**DICK'S EXCLUSIVE**

**Special 500**  
 • 12 ga. 28" or 20 ga. 26"  
 • Honey satin-finish stock and forearm • Twin-bead vent-rib barrel  
 • Ambidextrous safety • 6-shot capacity • Modified choke tube

**Save \$30**  
**189<sup>98</sup>**  
 Reg. 219.99

**Omega**  
 • .50 caliber in-line • 28" stainless barrel  
 • Patented pivoting action • 209 primer ignition  
 Capable of 150 grains of Pyrodex • Easy-to-clean Tru-Glo sights  
 • Hardwoods camo

**Save \$50**  
**399<sup>98</sup>**  
 Reg. 449.99

**Stoeger**

**Condor O/U or Uplander Nickel S/S**  
 • 12 or 20 ga. • 3" chambers • 2 chokes • Ventilated recoil pad  
 • Hardwood, oil-finished, hand-checked stock

**Save \$120**  
 OFF LIST  
**279<sup>98</sup>**  
 List 399.99  
 Now 329.99

**Beretta**

**SPECIAL PURCHASE —**  
**Whitewing O/U**  
 • 12 ga. 28" or 20 ga. 26"  
 • Matte-finish barrel with silver-etched receiver  
 • 3 interchangeable chokes

**Save \$150**  
 OFF LIST  
**899<sup>98</sup>**  
 List 1049.99  
 Now 999.99

**Daisy**

**Backyard Shooting Kit**  
 • Model 7840 Daisy Buckmaster BB/pellet rifle  
 • Shatterblast sashooter target system  
 • Rapid loader • 250-count pellets  
 • Sound Blaster target • Shatterblast targets • Shooting glasses

**Save \$50**  
 When Purchased as a Package  
**59<sup>98</sup>**  
 Reg. 69.99

## HUNTING GEAR • SAFES

Firearms and accessories sold separately

**Remington**

**HIGH VELOCITY**  
 All Purpose Load

**Remington Gun Club**  
 25 PLASTIC SHOTSHELLS

**STOCK UP ON AMMO WITH CASE DISCOUNTS**

	CASE PRICE <sup>1</sup> (PER BOX)	SALE	REG.
All-Purpose Shot Shells	2.23	2.48	2.99
Game Loads	2.68	2.98	3.79
Gun Club Shot Shells	3.13	3.48	4.49
Clay Targets	3.40	3.78	3.99

<sup>1</sup>Case price is price per box when you buy ten boxes or more

**Remington**

**UMC**

**UMC 9mm** .....5.98 Reg. 7.99  
 • Box of 50

**UMC .380 Auto or .38 Special**.....6.98 Reg. 8.99  
 • Box of 50

**UMC .45 ACP or .40 S&W** .....9.98 Reg. 12.99  
 • Box of 50

**Remington**

**.22 LR Shooting Gallery Gift Set**.....12.98  
 Reg. 14.99

**.22 Thunderbolts**...7.98 Reg. 8.99  
 • Brick of 500

**6500-Count Soft-Air BBs**...9.98  
 Reg. 11.99

**Smith & Wesson**

**M4505 Soft-Air Gun Kit**  
 • Spring-operated Spin-Up system  
 • 162 FPS velocity • 10-round ammo clip  
 • Includes sticky target and 100 plastic BBs

**Save 25%** **24<sup>98</sup>**  
 Reg. 34.99

**Remington**

**Stealth Cam Camo**...79.98  
 Reg. 89.99

**STEALTH CAM**

**ALL-WEATHER HOUSING Stealth Cam**  
 • Infrared motion detector wildlife scouting camera  
 • Uses 35mm film

**Save 25%** **59<sup>98</sup>**  
 Reg. 79.99

<sup>1</sup>Double ScoreCard Points not available in all locations

**Save \$40** OFF LIST  
**79<sup>98</sup>**  
 List 119.99  
 Now 89.99

**ADJUSTABLE STORAGE**  
**8-Gun Cabinet**  
 • 8-gun storage up to 54" tall  
 Online ID# 964927

**Save \$120** OFF ORIG.  
**329<sup>98</sup>**  
 Orig. 449.99  
 Now 369.99

**ELECTRONIC LOCK**  
**16-Gun E-Lock Safe**  
 • Solid steel • 5 large locking bolts • Removable carpeted shelf for added storage  
 Online ID# 1866921

**Save \$100** OFF ORIG.  
**499<sup>98</sup>**  
 Reg. 599.99

**FIRE PROTECTION TO 1400°F**  
**20-Gun Fire Safe**  
 • Convertible to hold 13 guns with adjustable shelving for accessory storage  
 Online ID# 1866922

**Multi-Plier 400 Tool**...29.98  
 Reg. 34.99 (Shown)  
 Online ID# 753888

**ONLINE ID# 1870030**

**GERBER**

**All Gerber Multi-Tools**

**Take \$10 OFF**

• Choose from Summit, Hunter's View, Comfort Zone and River's Edge

**All Remaining Tree Stands**

**We've Taken Up To \$120** OFF LIST

**AIRLINE APPROVED —**  
**Aluminum Double-Gun Case**  
 • 53"x13"x4 1/2"  
 • High-density foam • 4-lock system  
 • Firearms sold separately  
 ✓ Double ScoreCard Points

**Save 50%** **49<sup>98</sup>**  
 Orig. 99.99  
 Now 59.99

**NORTHEAST OUTFITTERY**

• Choose from jackets, bibs and more

**All Insulated Hunting Clothing**

**Save Up To 50%** OFF ORIG.  
 Online ID# 1881038



## DICK'S RIGHT PRICE PROMISE

With DICK'S RIGHT PRICE PROMISE you get guaranteed low prices. We've shopped the competition, but if you find a lower price we'll match it. Find a lower price after the sale and we'll refund the difference...that's our promise. (See store locations for complete details.)

**HOLIDAY STORE HOURS:**  
 Sun. 9am - 9pm  
 Mon. thru Thurs.  
 9am - 10pm  
 Fri. & Sat. 8am - 10pm  
 (Lansing: Sun. & Mon. 8am - 10pm)

**INDIANA**  
 Fort Wayne: 260.434.0181  
 Coliseum Boulevard: 260.470.4224  
 Mishawaka: 574.243.4789  
 Evansville: 812.402.9100  
 Avon: 317.271.7850  
 Greenwood Park Mall: 317.882.1079  
 Allseville Road: 317.578.3586  
 Clay Terrace: 317.818.3467  
 Lafayette: 765.449.0914

**Washington**  
 Square Mall: 317.890.8902  
 Plainfield: 317.839.2316  
 Castleton Square Mall: 317.576.0300  
 Traders Point: 317.956.1400  
 Greenwood Crossing: 317.851.1400

**MICHIGAN**  
 Troy: 248.572.2879  
 Taylor: 734.374.0429  
 Westland: 734.523.0984  
 Utica: 586.254.2653  
 Rochester Hills: 248.608.9696  
 Northville: 248.735.8180  
 Saginaw: 989.793.3346  
 Lansing: 517.702.1300  
 Novi: 248.596.3400  
 Okemos: 517.853.0400  
 Mesquite: 231.798.8003

**ILLINOIS**  
 Rockford Area: 815.397.7115  
 Champaign: 217.352.4173  
 Normal: 309.454.1602  
 Springfield: 217.726.6451

**WISCONSIN**  
 Green Bay: 920.490.8488  
 Appleton: 920.954.9266  
 Racine: 262.554.8117  
 East Madison: 608.241.2764  
 West Madison: 608.829.1313  
 Middleton: 608.828.1400

**For the store location nearest you, please call 1.866.819.0038**

We reserve the right to limit quantities. Not responsible for typographical errors. All savings shown off regular or original prices. For percentage-off discounts, interim markdowns may have been taken. Sorry, Women's Columbia casual apparel is not available in our Champaign, Racine, Troy, Taylor, Westland, Utica, Appleton and Green Bay locations.

SALE EFFECTIVE: **NOV 28 29 30 1 2 3 4**

You can e-mail us with any comments regarding service at [customer.service@dcs.com](mailto:customer.service@dcs.com) or call our toll-free number at 1.866.677.4771

For the store location nearest you, please call 1.866.819.0038

**DICK'S**  
 SPORTING GOODS



EVERY SEASON STARTS AT

**DICK'S**  
SPORTING GOODS

# Great Gifts for Your Favorite Golfer

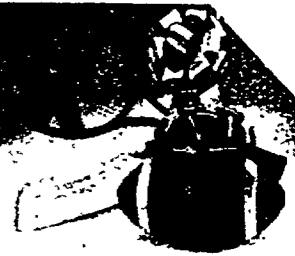

Men's 1/4 Zip Fleece  
24.98 Reg. 49.99

2-Piece Rainsuit  
29.98  
Orig. 59.99  
Now 49.99

Windshirt  
19.98 Reg. 39.99

Windvest  
14.98 Reg. 29.99

Double ScoreCard Points

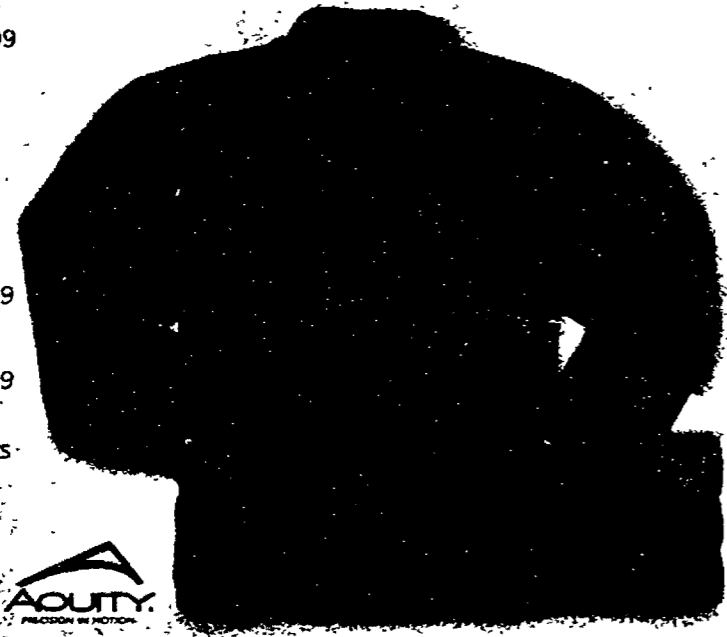

Save



**50%**  
OFF ORIG.

All Acuity Golf Outerwear

## GOLF

TaylorMade

ONLINE ITEM ID# 1195211

**TITANIUM**  
**A. Men's or Women's R540 Driver**  
• Tunable weight cartridge  
• Graphite shaft • Men's right- and left-handed  
• Women's right-handed Orig. 399.99

OR

ADAMS

**B. Men's Redline Driver**  
• 460cc clubhead  
• Graphite shaft  
• Men's right-handed  
Orig. 299.99  
2004 Golf Digest "Hot List" Recommended Driver

ONLINE ITEM ID# 1882258

Save Up To **\$240** OFF ORIG.

Your Choice

**159<sup>99</sup>**

Save UP TO **60%** OFF ORIG.



DICK'S EXCLUSIVE

**A. Raw Distance**

- Soft and durable ionomer cover
- Titanium-enhanced core offers excellent distance
- 12-ball pack Reg. 19.99 each



A

**B. MC Lady**

- Super-soft core
- Explosive distance with soft feel
- 12-ball pack Reg. 19.99 each

PRECEPT

B

Buy One Get One

**FREE**†

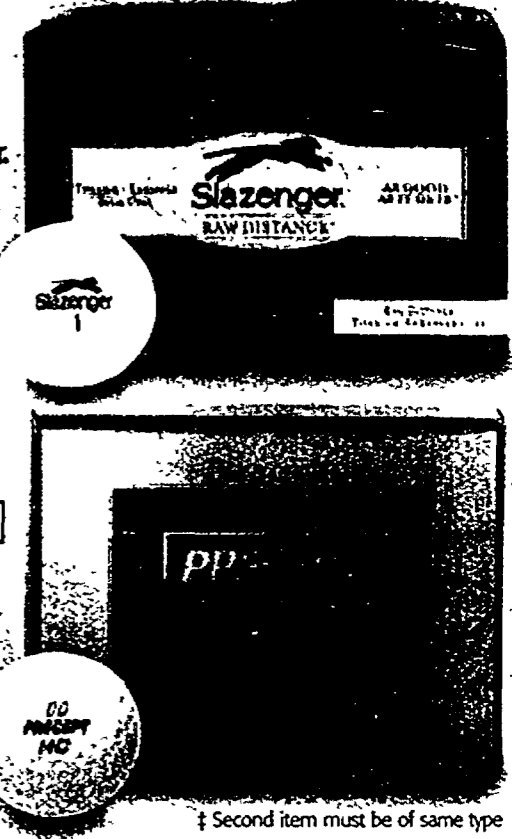

† Second item must be of same type



All Men's Acuity and Women's Ativa Golf Apparel  
✓ Double ScoreCard Points  
Sale 14.98-54.98 Reg. 19.99-69.50

Save Up To **25%**



Men's FootJoy WinterSof Gloves  
19.98 Reg. 21.99  
Online ID# 931247



1-YEAR WATERPROOF WARRANTY

Men's or Women's Terrains  
• Soft and comfortable leather upper  
• Duramax rubber outsole with SoftSpikes XP deats  
• Closeout styles #57654 and #98375

Save 25% **59<sup>98</sup>**  
Reg. 79.99

2003 Golf Digest Editors' Choice Fairway Wood of the Year

Callaway

VFT TECHNOLOGY  
**Men's Steelhead III Fairway Wood**  
• Steel clubface with Variable Face  
• Thickness technology  
• Steel shaft  
• Men's right- and left-handed



Save \$60 OFF ORIG. **119<sup>99</sup>**  
Orig. 179.99

TaylorMade

TITANIUM  
**Men's R580 Driver or Fairway Wood**  
• 400cc driver  
• Pull-Face construction provides a thin face in a larger clubhead  
• High launch angle and high spin  
• Graphite shaft  
• Men's right-handed

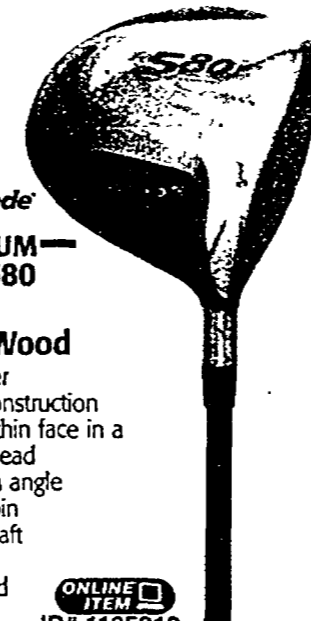

ONLINE ITEM ID# 1195212  
Save UP TO **50%** OFF ORIG. **199<sup>99</sup>**  
Orig. 329.99-399.99



Free Personalization on Select Styles of Titleist Golf Balls  
• Available on Pro V1, Pro V1x, DT SoLo, NXT and NXT Tour  
• See store for details  
• Offer ends 12/8/04

Special Offer

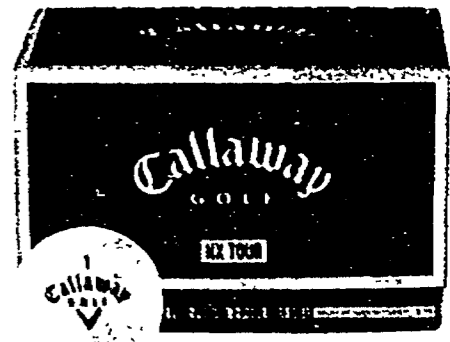

Callaway  
**HX Tour**  
• 3-piece construction  
• Thin cover maximizes distance, while providing bite around the greens for short-game control  
• 12-ball pack

ONLINE ITEM ID# 1446318  
Great Gift **39<sup>99</sup>**



Take an Extra \$20 Off All Golf Bags \$109.99 or more  
Online ID# 1878644  
Take an Extra \$10 Off All Golf Bags \$59.99-\$109.98  
Online ID# 1878657



ONLINE ITEM ID# 1866756  
All Golf Travel Covers and Carts \$49.99 or more  
Take an Extra **\$10 OFF**

Kids' Cadet Pro Jr. Set  
89.99  
Orig. 129.99

Acuity

10-PIECE JUNIOR SET  
**Kids' Cadet Pro II Deluxe Jr. Set**  
• Oversized driver and cavity-back irons with graphite shafts  
• Kids' right- and left-handed  
✓ Double ScoreCard Points

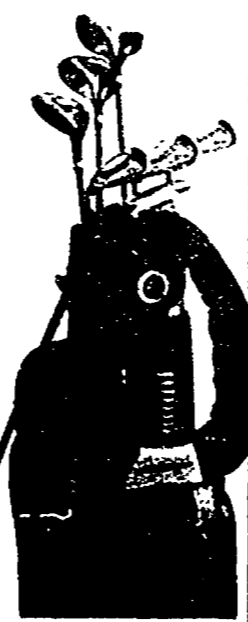

Save \$40 OFF ORIG. **109<sup>99</sup>**  
Orig. 149.99

Acuity

ONLINE ITEM ID# 1710552

16-PIECE SET  
**Men's or Women's XP Deluxe Combo**  
• Driver and stainless-steel fairway woods with graphite shafts  
• 4-SW irons  
• Alignment putter  
• Includes deluxe cart bag and head covers  
• Men's and Women's right- and left-handed  
✓ Double ScoreCard Points



Save \$120 OFF ORIG. **179<sup>98</sup>**  
Orig. 299.99  
Nov 199.99



ONLINE ITEM ID# 1875918  
**TOP-FLITE**  
**36 GOLF BALLS— XL 2000 Super Titanium**  
• Titanium cover  
• Tungsten-enhanced core for explosive distance with soft feel  
• Double 18-ball packs

Save 33% OFF ORIG. **19<sup>99</sup>**  
Orig. 29.99



**TAZ Long and TAZ Spin**  
• Durable, responsive urethane-blended cover for distance with a snap-velocity core  
• 12-ball pack

ONLINE ITEM ID# 1866009  
Save 33% OFF ORIG. **19<sup>99</sup>**  
Orig. 29.99

✓ Double ScoreCard Points not available in all locations

Shop us online at DicksSportingGoods.com or order by phone at 1.877.846.9997

Le  
de TOUR  
FRANCE

OFFICIAL TIMEKEEPER



\$299





\$395

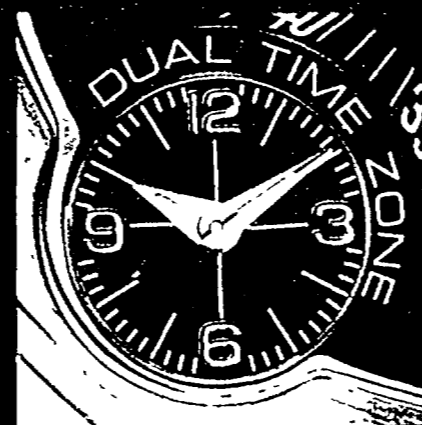
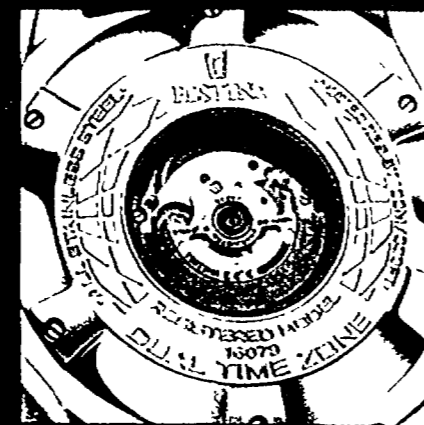

FESTINA

Front Cover: The Tour de France Special Edition. Stainless steel chronograph,

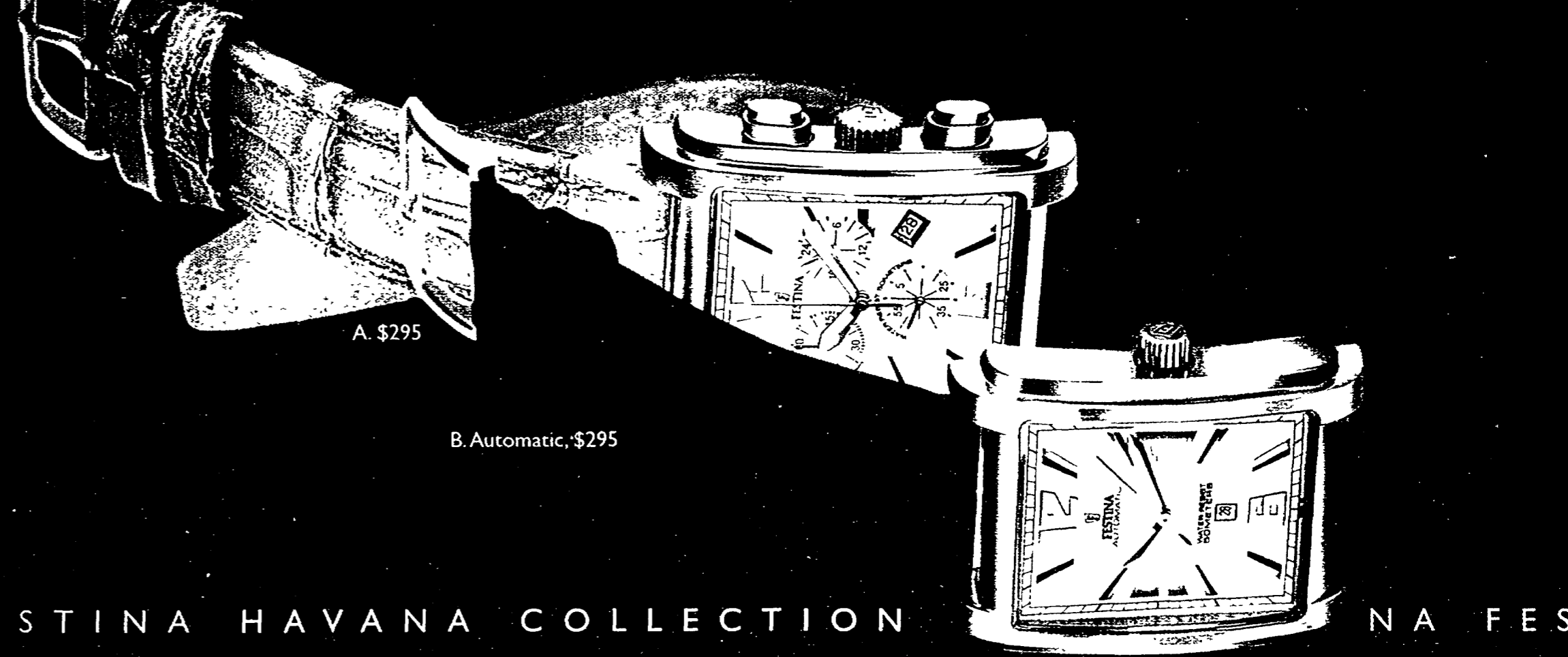

A. \$295

B. Automatic, \$295

TINA FESTINA FESTINA HAVANA COLLECTION NA FES

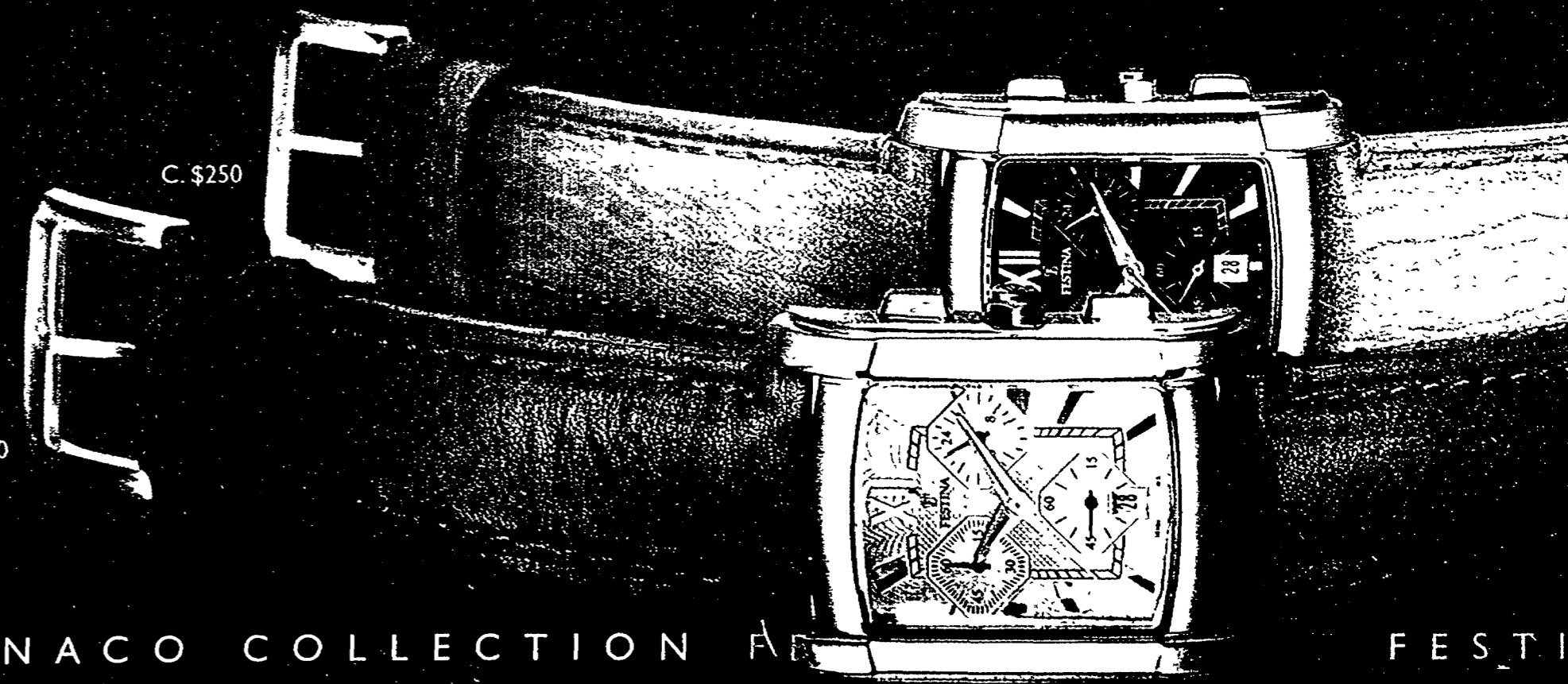

C. \$250

D. \$250

FESTINA MONACO COLLECTION FESTI

The Havana Collection. A. Stainless steel chronograph with leather strap,





\$250

ON FESTIN

TIN

\$250

\$250

\$250

\$195



**Jewelry  
Design**

43155 Main Street • Suite 304  
Novi, Michigan 48375-1774  
248-347-4653 • Fax: 248-3745665

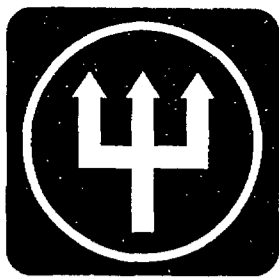

# WÜSTHOF®

Precision Forged Perfection - Solingen, Germany - Since 1814

## HOLIDAY GIFT SALE!

HOLLOW-GROUND SANTOKU KNIVES FROM **WÜSTHOF**-A True Cooking Phenomenon!

Chef's everywhere have finally discovered "that one great knife." Alternating "hollows" on each side of the super-sharp blade reduce drag allowing the knife to glide effortlessly as you cut. Chopping, mincing, dicing and slicing. By far, the most versatile knife in the well-equipped kitchen. *Get yours today and see what all the excitement is about!*

### CLASSIC *Santoku Knives*

Precision-forged, hi-carbon, stain-resistant steel with traditional, triple-rivet handles & full tang construction. Available in NEW 5" and the now-famous original 7" blade lengths. Each individually gift boxed.

*New!*

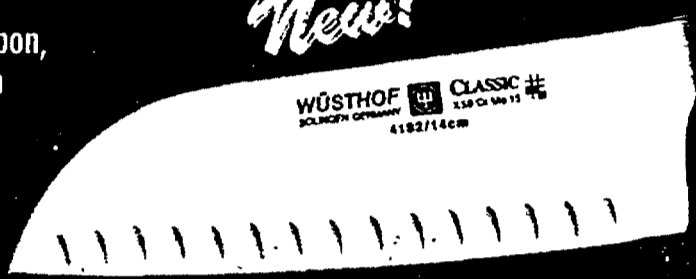

**\$74.99**

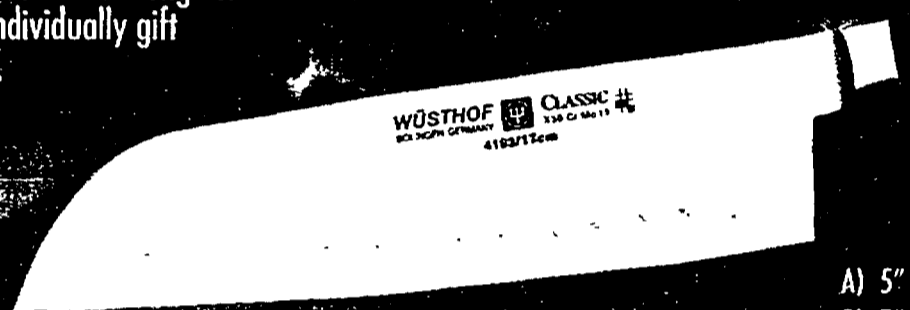

**\$89.99**

A) 5" Santoku Knife (#4182) Regularly \$100 SALE: \$74.99  
B) 7" Santoku Knife (#4183) Regularly \$120 SALE: \$89.99

## SAVE OVER \$200 ON OUR BEST-SELLER! CLASSIC 8 PIECE KNIFE BLOCK SET

Five essential knife styles, kitchen shears and honing steel in our 17 slot knife block (6 steak knife slots in the base) with room to expand. (Plenty of room for either or both of the Santoku knives above).

**\$299.99**

- Contains:
- 3 1/2" paring knife,
  - 4 1/2" utility knife,
  - 6" sandwich knife,
  - 8" bread knife,
  - 8" cook's knife,
  - 9" steel, come-apart shears,
  - 17 slot block #8800

Regularly \$510.00  
SALE: \$299.99

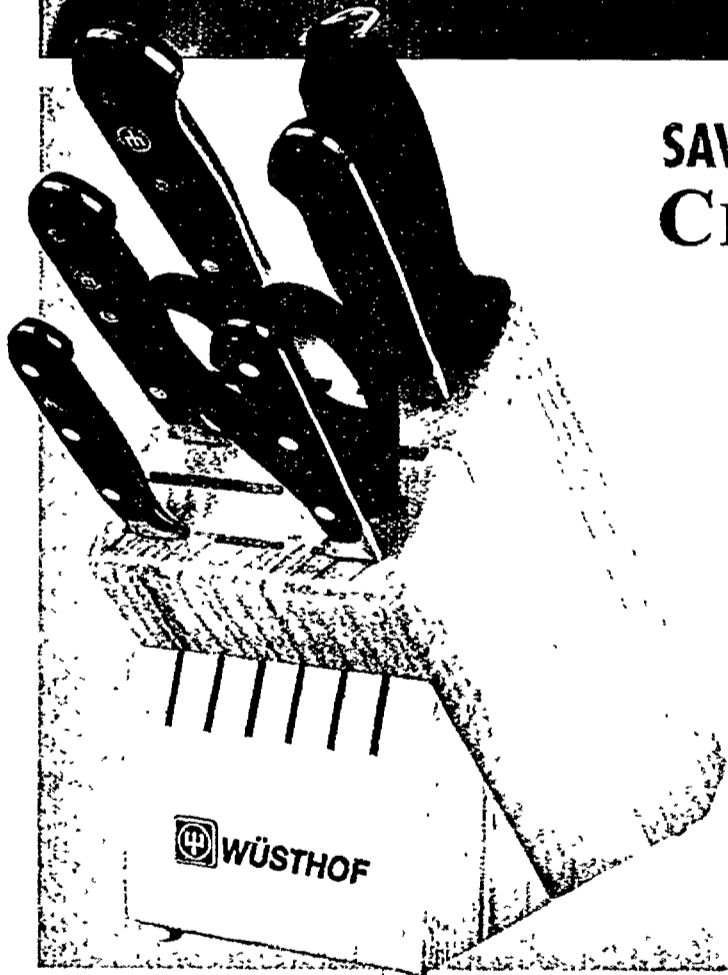
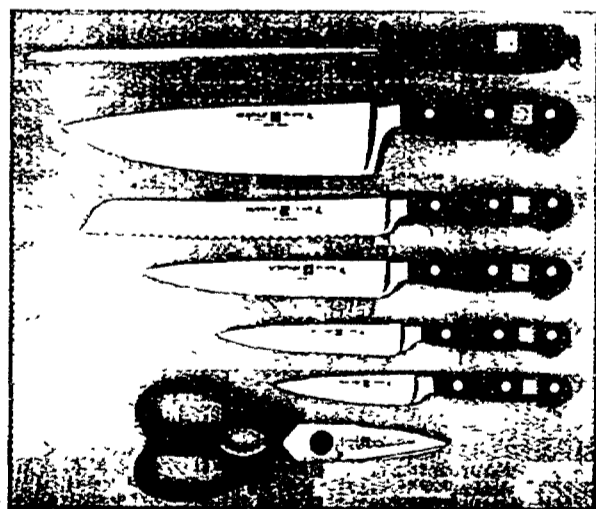

WÜSTHOF - Trident of America, Inc. 333 South Highland Avenue, Briarcliff Manor, NY 10510 Tel: 914.923.6000 Fax: 914.923.6514 www.wusthof.com



The Kitchen Witch

134 East Main Street  
Northville, Michigan 48167  
"A Unique  
Kitchen Shop"  
(248) 348-0488  
Fax (248) 348-3046



Some items may not be available in all stores. Special orders are cheerfully accepted. Prices valid through January 31, 2005.

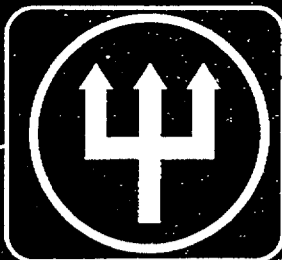

WÜSTHOF

# CLASSIC OPEN STOCK VALUES

\$29<sup>99</sup>

\$39<sup>99</sup>

\$34<sup>99</sup>

\$34<sup>99</sup>

\$34<sup>99</sup>

## Cook's Knives:

THE kitchen workhorse and the PROFESSIONAL CHEF'S best friend. These tools are what precision-forged cutlery is all about. Solid. Hefty. Five sizes to choose from. Each a perfectly balanced chopping and dicing machine.

- A) **NEW!** 4 1/2" "Multi-Prep" Cook's Knife (#4582-7/12) Regularly \$75 SALE: \$49.99
- B) 6" Cook's Knife (#4582/16) Regularly \$86 SALE: \$64.99
- C) **BEST SELLER!** 8" Cook's Knife (#4582/20) Regularly \$120 SALE: \$89.99
- D) 9" Cook's Knife (#4582/23) Regularly \$128 SALE: \$99.99
- E) **PROFESSIONAL!** 10" Cook's Knife (#4582/26) Regularly \$136 SALE: \$109.99

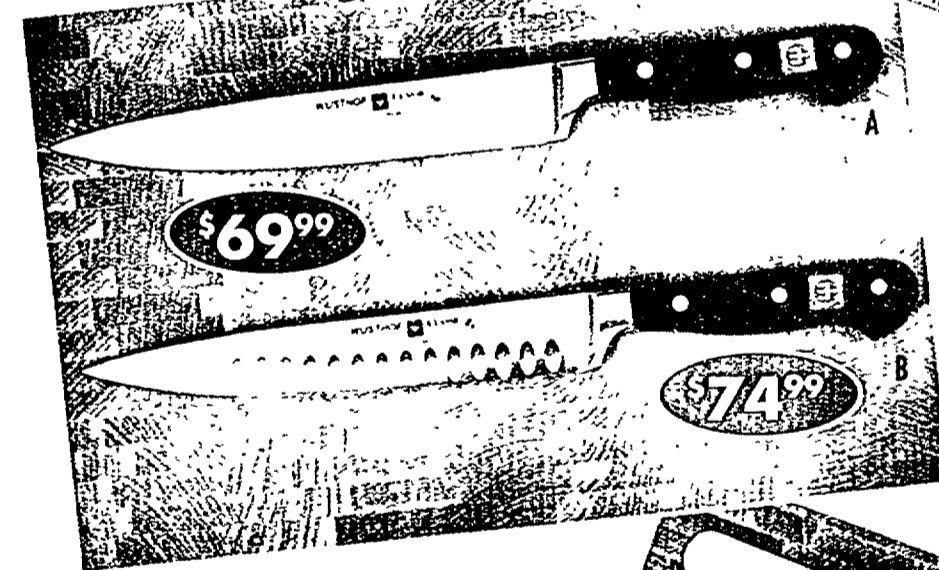
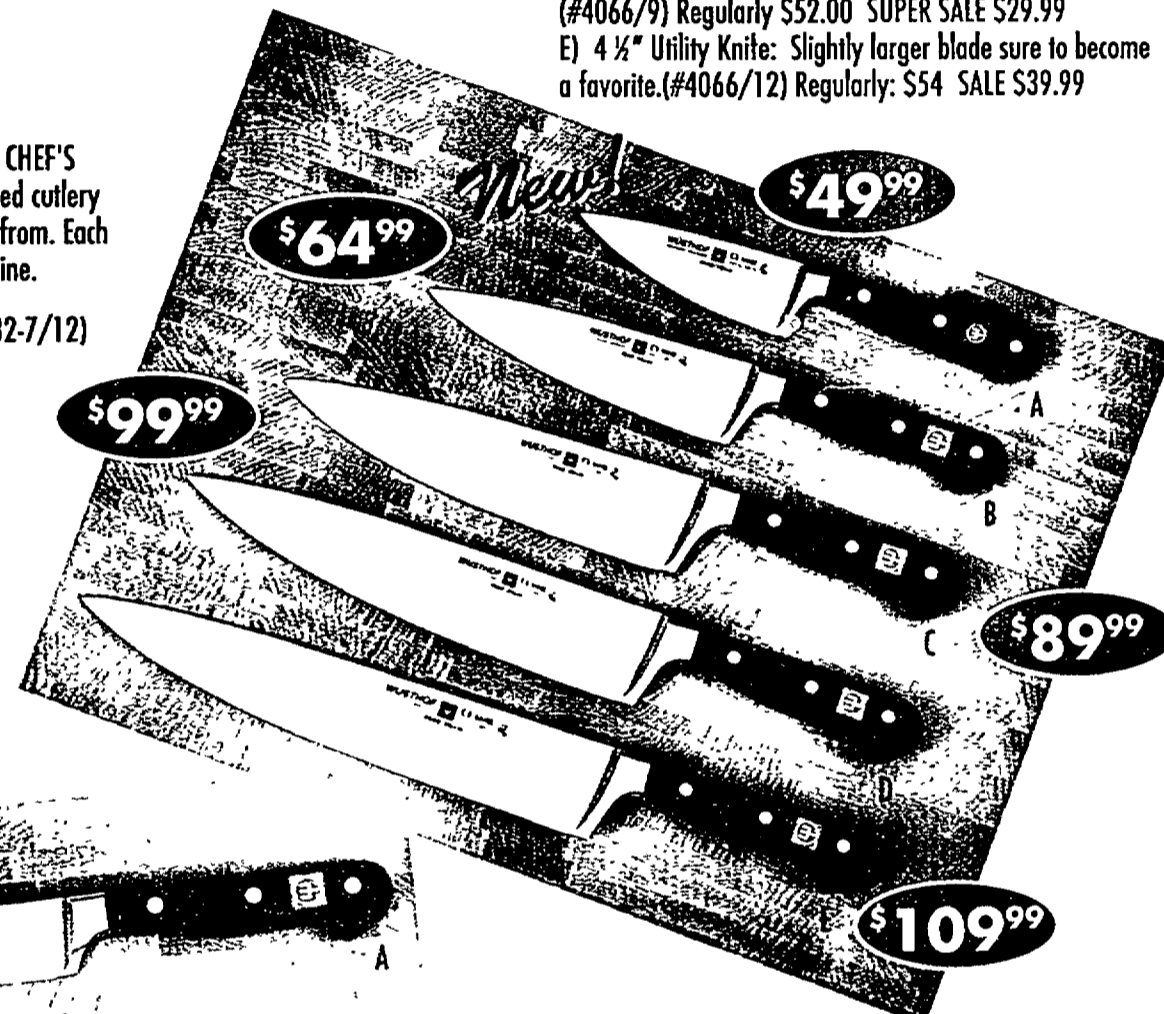

## "SUPER SLICER" & Bread Knives

Only a serrated edge will pierce the crustiest of loaves without crushing the soft interior. Choose the size based on the breads you love the most.

The unique "WAVY EDGE" serration and blade shape of the 10" Super Slicer allows this knife to carve and slice meats without shredding...AND slice breads, cakes and other delicate baked goods too!

- A) 10" Super Slicer (#4532-7/26) Regularly \$120 SALE: \$79.99
- B) 8" Bread Knife (#4149) Regularly \$89 SALE: \$64.99
- C) 9" Bread Knife, larger handle/wider blade (#4150) Regularly \$105 SALE: \$74.99



GREAT SAVINGS WHEN YOU CHOOSE FROM ANY OF OUR BEST SELLING OPEN STOCK ITEMS!

## Paring and Utility Knives:

- You can never own too many of these useful knives.
- A) 2 3/4" "Bird's Beak" Peeling Knife: For garnishing and working on curved fruits and veggies. (#4062) Regularly \$52 SALE \$34.99
- B) 2 3/4" Trimming Knife: Mini-boning knife shape gets into those tight spots where other knives cannot. (#4002) Regularly \$52 SALE \$34.99
- C) 3" Serrated Parer: Perfect for around the bar, always sharp. (#4003) Regularly \$55 SALE \$34.99
- D) 3 1/2" Paring Knife: Our benchmark paring knife and perennial best-seller. (#4066/9) Regularly \$52.00 SUPER SALE \$29.99
- E) 4 1/4" Utility Knife: Slightly larger blade sure to become a favorite. (#4066/12) Regularly: \$54 SALE \$39.99

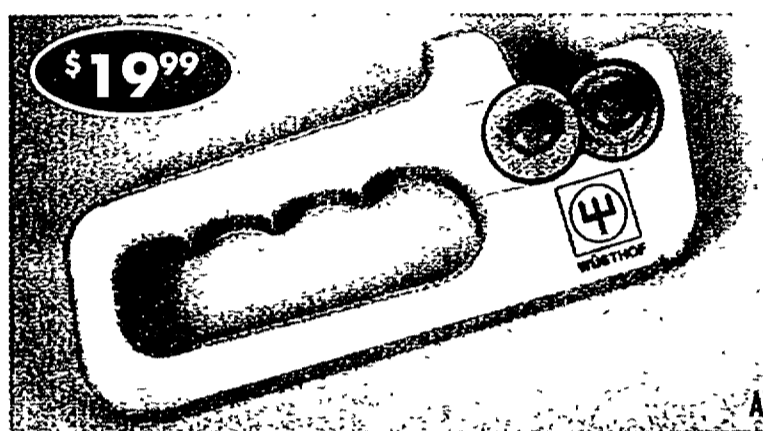

At last, professional quality knives for the left-handed user. Serrations ground on the "opposite" side of the blade are the key to the design. Each is individually gift-boxed. A great gift for the Southpaw on your Holiday list.

- A) Left-Handed 9" Bread Knife (#4150-1) Regularly \$105 SALE: \$74.99
- B) Left Handed 10" Super Slicer/Carver (#4532-1) Regularly \$120 SALE: \$79.99
- C) Left-Handed 5" Serrated Utility/Tomato/Bagel Knife (#4110-1) Regularly \$73.00 SALE: \$49.99

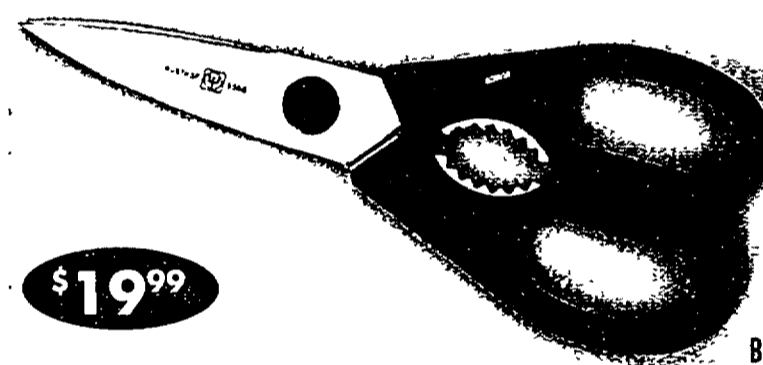

Great, practical and useful gifts for every kitchen. Choose from:

- A) Hand-held Ceramic Sharpener (#2900) Regularly \$25
- B) Come-Apart (for sharpening and cleaning) Kitchen Shears (#5558) Regularly \$30
- C) 9" Honing Steel (#4463/23) Regularly \$30
- D) Garlic Press w/fine & coarse screens (#4290) Regularly \$36



**YOUR CHOICE  
\$19.99**

## Carving & Slicing Knives:

Each with an 8" blade, choose from Fine Edge or super-sharp Hollow Ground styles. "Carving" knives are also a must for breaking down larger fruits and vegetables! Slice wafer thin with the Hollow version.

- A) 8" Carving Knife w/fine edge (#4522/20) Regularly \$96 SALE: \$69.99
- B) 8" Carver/Slicer w/Hollow Ground Edge (#4524/20) Regularly \$105 SALE: \$74.99

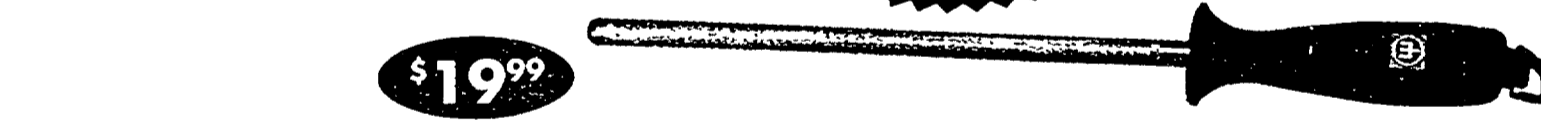

## STEAK SETS

### Steak Sets-GREAT GIFTS!

Our top-of-the-line CLASSIC four-piece set. Same precision-forged single-piece construction found on ALL of our CLASSIC Series knives. The "Filet Mignon" of steak knife sets. (#9731) Regularly \$216 SALE: \$159.99

4 piece, all stainless-steel steak knives in satin-finished aluminum gift chest. Our best value in a presentation steak set. (#8460-9) Regularly \$90 SALE: \$49.99



8 piece, all stainless-steel steak knives in Rosewood gift box. An impressive gift for the steak lover on your Holiday list. (#9468) Regularly \$140 SALE: \$89.99

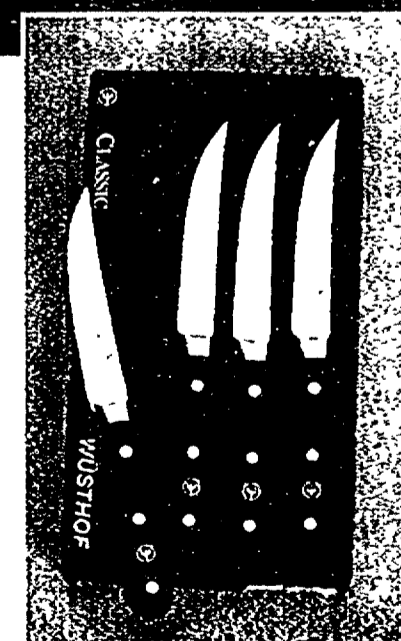





*New!*

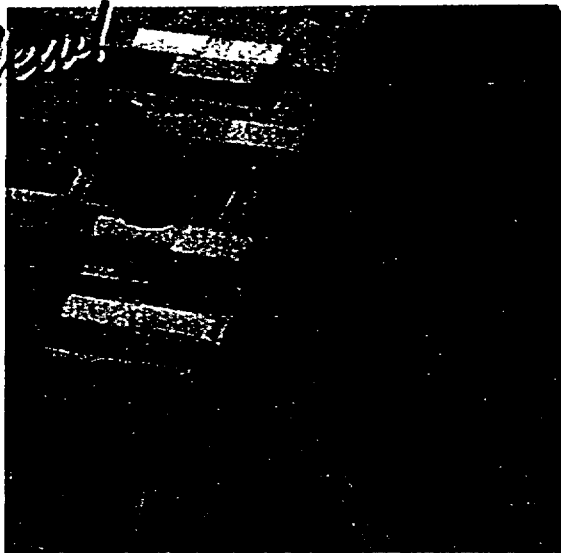

**\$69<sup>99</sup>**

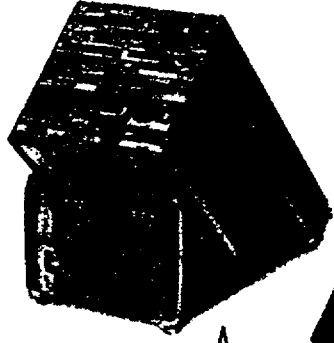

A

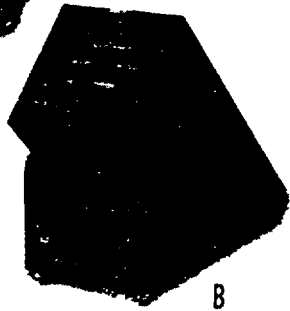

B

**Luxurious. Unique.**  
**NEW! BAMBOO KNIFE STORAGE BLOCKS**  
 Beautiful and richly-grained, these blocks add a simple touch of elegance.

- A) 22 Slot Bamboo Block (#7278) Regularly \$100 SALE: \$69.99
- B) 17 Slot Bamboo Block (#7277) Regularly \$70 SALE: \$49.99

**\$49<sup>99</sup>**

**CLASSIC TWO PIECE ASIAN-STYLE GIFT SET**

A perfect way to start your knife collection. Contains the popular 7" Hollow Ground Santoku knife and 3" "Flat Cut" paring knife.  
 Classic Two Piece Asian Set (#9280)  
 Regularly \$172 SALE: \$109.99

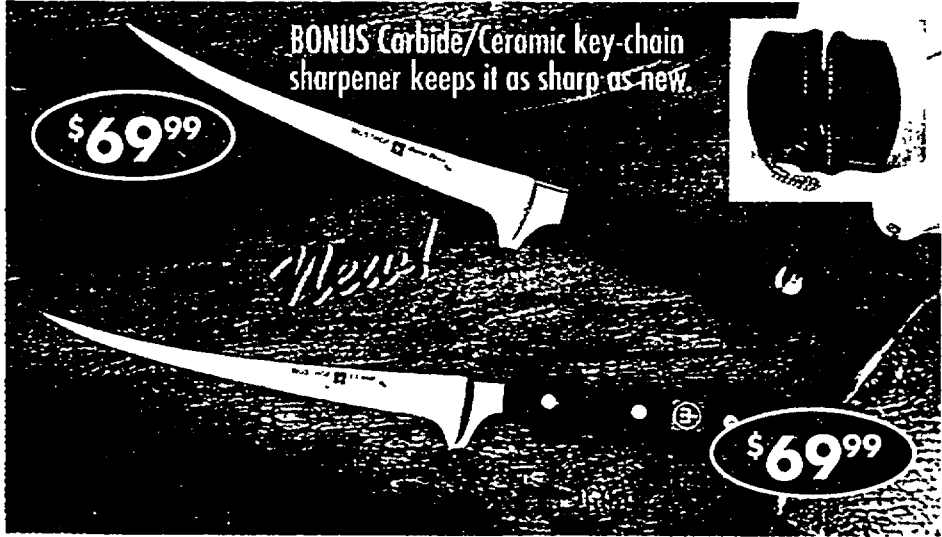

**BONUS** Carbide/Ceramic key-chain sharpener keeps it as sharp as new.

**\$69<sup>99</sup>**

**\$69<sup>99</sup>**

**NEW! 7" FILLET KNIFE GIFT SETS W/BONUS TWO STAGE SHARPENER**

Razor sharp. Super thin and flexible. Choose from **CLASSIC** or **NEW! GRAND PRIX II**. Each comes gift-boxed with its own leather belt scabbard. Bonus Carbide/Ceramic keeps them as sharp as new.

- A) NEW! **CLASSIC 7" Fillet Knife Gift Set (#4622WS)** Regularly \$100 SALE: \$69.99
- B) NEW! **GRAND PRIX II 7" Fillet Knife Gift Set (#4625WS)** Regularly \$100 SALE: \$69.99

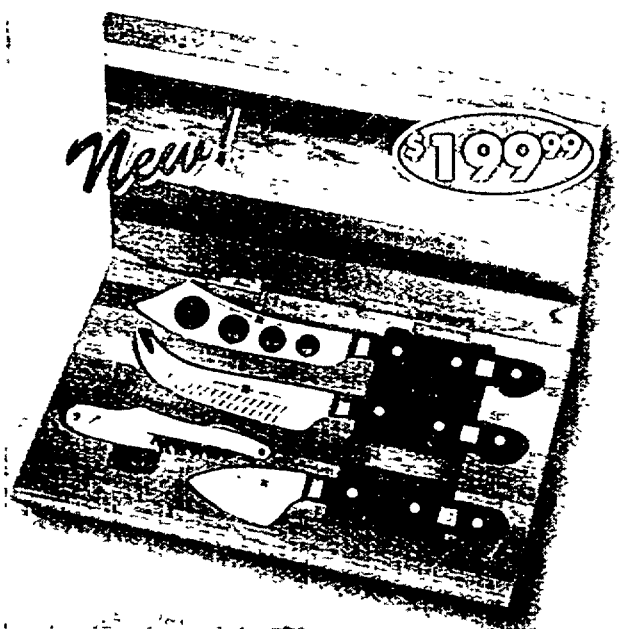

**\$199<sup>99</sup>**

**NEW! CLASSIC Four Piece Cheese & Wine Lovers Set in Bamboo Gift Box**

With three stylishly designed blades for hard, soft and parmesan cheeses, this set is sure to impress. Waiters-style corkscrew completes the presentation. Beautifully presented in rich bamboo. (#2100-9)  
 Regularly \$260 SALE: \$199.99

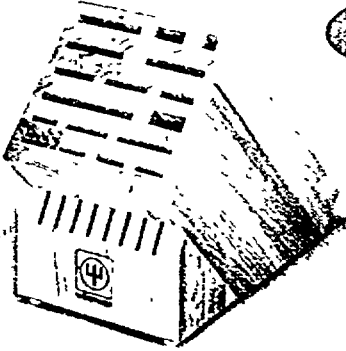

**\$79<sup>99</sup>**

**25 SLOT SOLID AMERICAN OAK "MEGA BLOCK"**

Our largest block will hold up to four cook's knives, 8 steak knives, shears and much, much more. (#7259) Regularly \$100 SALE: \$79.99

**\$49<sup>99</sup>**

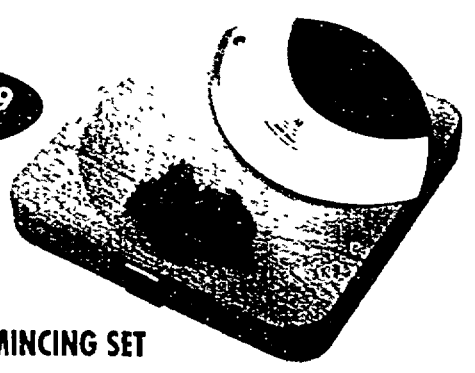

**TWO PIECE MINCING SET**

With an 8" (across) Mezzaluna and cutting board/bowl (shaped-to-size), small to medium chopping and fine mincing jobs are performed with ease. (#9881) Regularly \$80 SALE: \$49.99

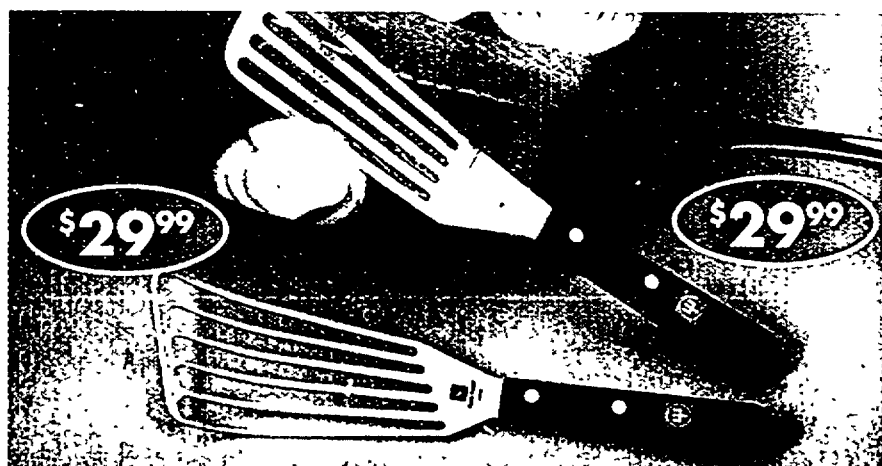

**\$29<sup>99</sup>**

**\$29<sup>99</sup>**

**SLOTTED SPATULAS**

Leave pan juices and oils behind with these chef's favorites. The offset style is THE spatula for turning delicate fish. Both are great on the grill too.

- A) 4" Narrow Slotted Spatula (#4434) Regularly \$42 SALE: \$29.99
- B) 5" Offset Slotted Spatula (#4433) Regularly \$42 SALE: \$29.99

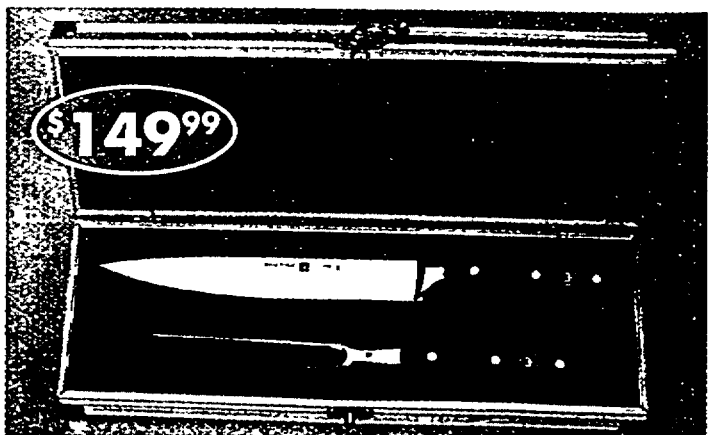

**\$149<sup>99</sup>**

**CLASSIC TWO PIECE PRESENTATION CARVING SET**

Our top-of-the-line set. Satin-finished aluminum gift chest gives this set that true "Special Occasion" feel. Contains 6" carving fork and 8" Carving knife. (#9740-9) Regularly \$220 SALE: \$149.99



# LORENZO

Artistic Expressions in Sterling & 18 Karat Gold

Contemporary designs  
pairing sterling silver  
and 18K gold with  
the world's most  
exquisite gems.





L402A Concave trillion cut amethyst earrings \$275

L402B Matching amethyst pendant on a sterling silver link chain \$295

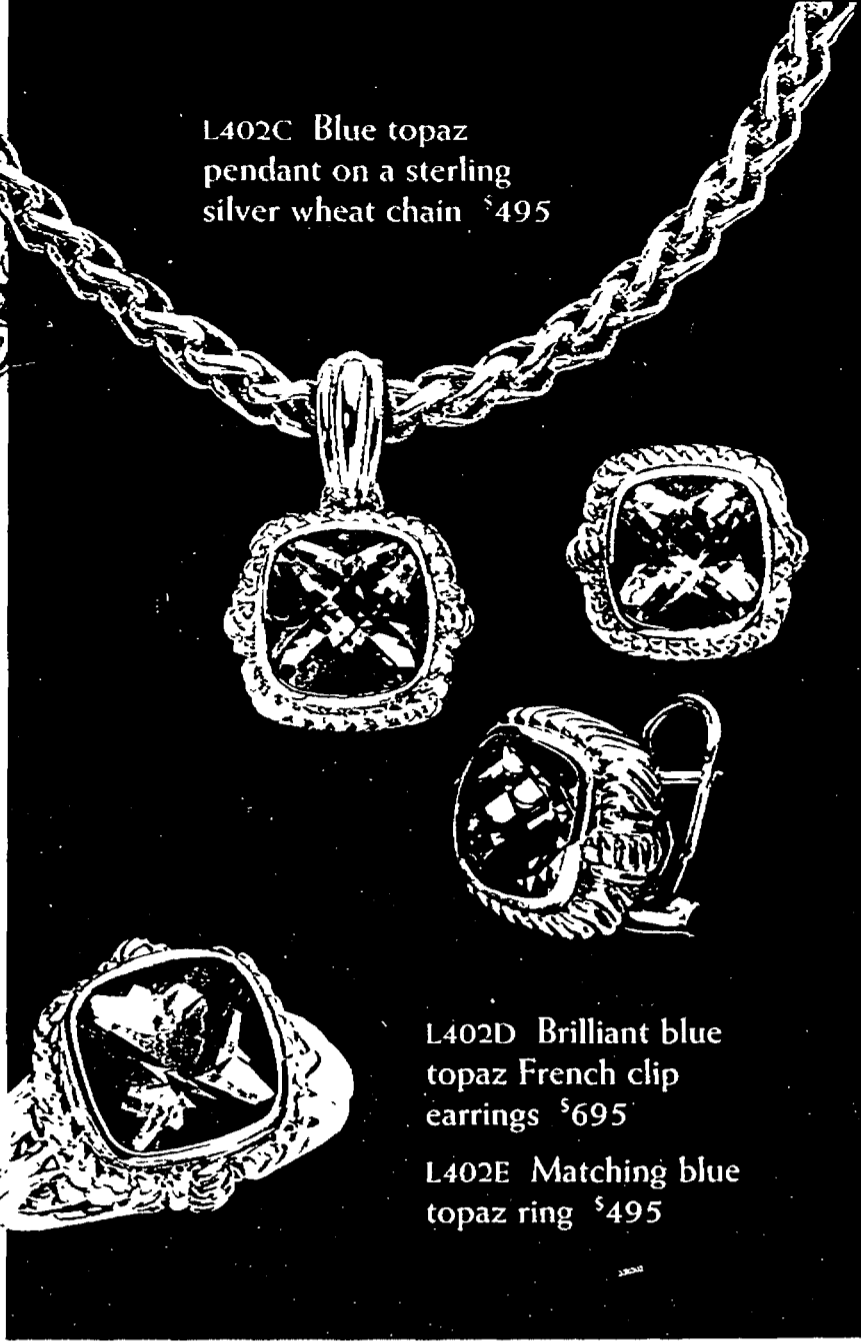

L402C Blue topaz pendant on a sterling silver wheat chain \$495

L402D Brilliant blue topaz French clip earrings \$695

L402E Matching blue topaz ring \$495

Dream in Black & White,  
Wake to Brilliant Color...

# LORENZO

Artistic Expressions in Sterling & 18 Karat Gold



L402F Vibrant square cut citrine earrings \$250

L402G Matching citrine ring \$225

L402H Bypass bracelet in faceted amethyst \$495

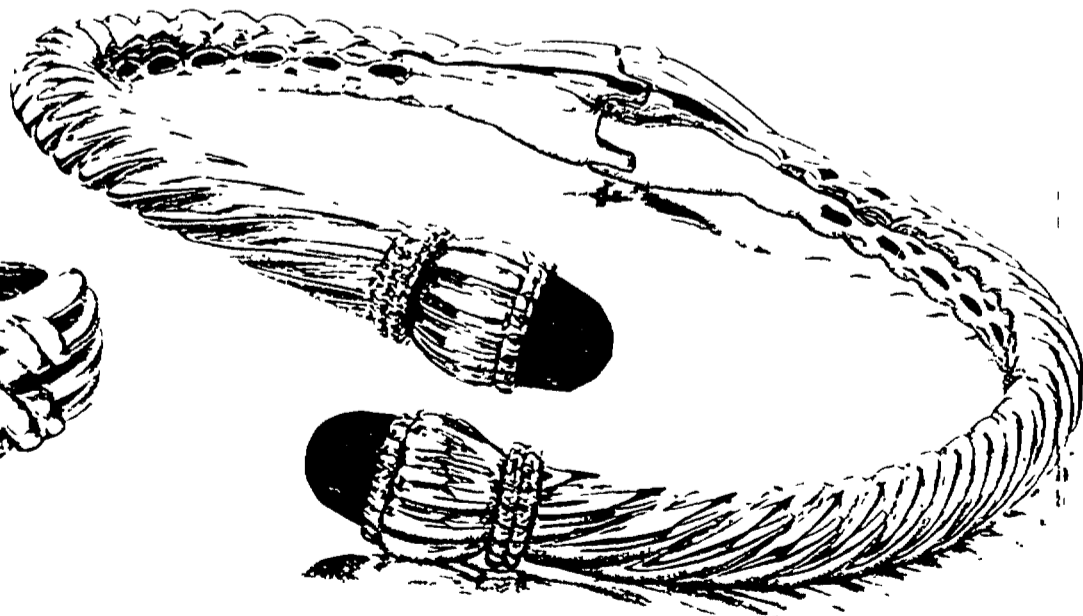

On the cover: L401A Faceted citrine bead necklace \$595  
L401E Necklace in onyx \$475

L401B Matching citrine bracelet \$495  
L401D Bracelet in onyx \$395

L401C Matching citrine drop earrings \$250  
L401F Earrings in onyx \$195



When Sterling and  
18K Gold is all you need...

SENZA PIERRA  
*by*  
LORENZO

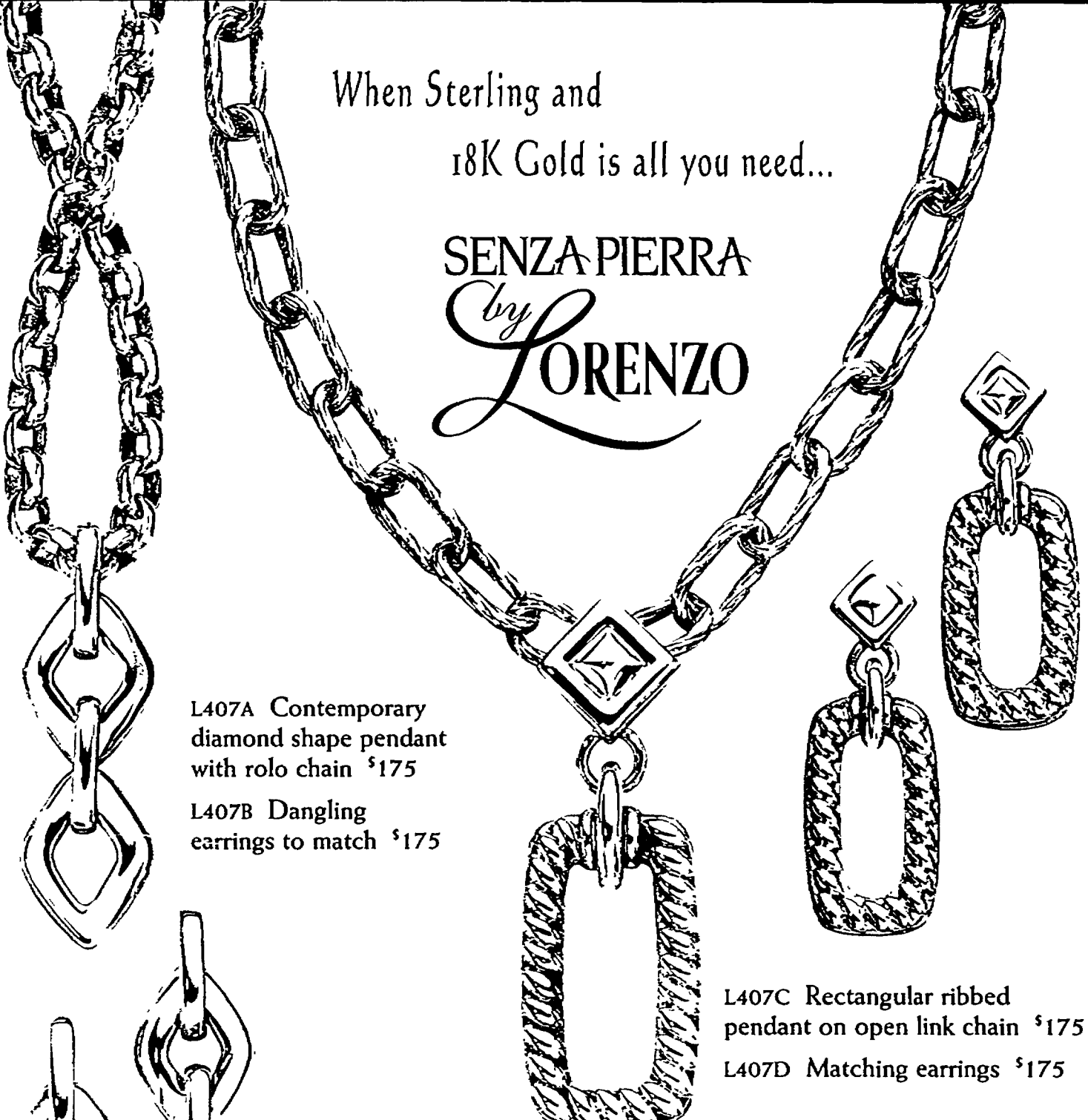

L407A Contemporary  
diamond shape pendant  
with rolo chain \$175

L407B Dangling  
earrings to match \$175

L407C Rectangular ribbed  
pendant on open link chain \$175

L407D Matching earrings \$175

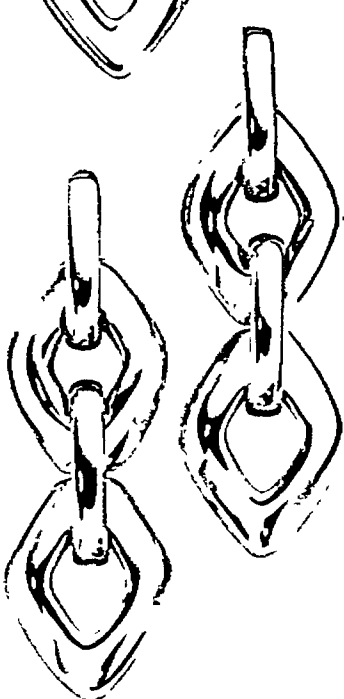

L407F Ring with 18K  
textured center \$275

L407G Bold modern  
ring \$195

L407H Criss cross  
ring \$195



L407E Elegant hinged  
bangle bracelet \$395



Jewelry enlarged to show detail. All items are sterling silver and 18K gold, unless otherwise noted. We reserve the right to make corrections for errors. If advertised item is unavailable, we will try to offer a similar item at advertised price. Prices may vary due to fluctuations in the gold and diamond markets. SGS maintains all rights pertaining to usage and reproduction in any form of this catalog. ©2004. Printed in USA.

L408A Elegant garnet,  
amethyst and peridot  
chandelier earrings \$295

L408C Colorful earrings  
in pear shape garnet  
and citrine \$250

L408E Garnet ring with  
textured design \$225

L408E

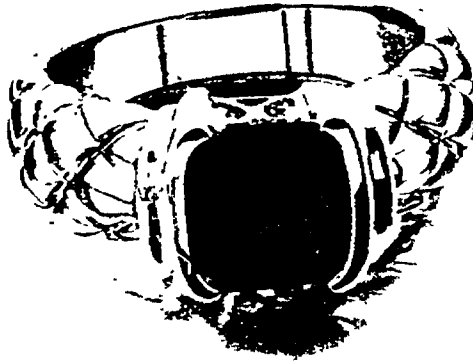

L408C



L408A

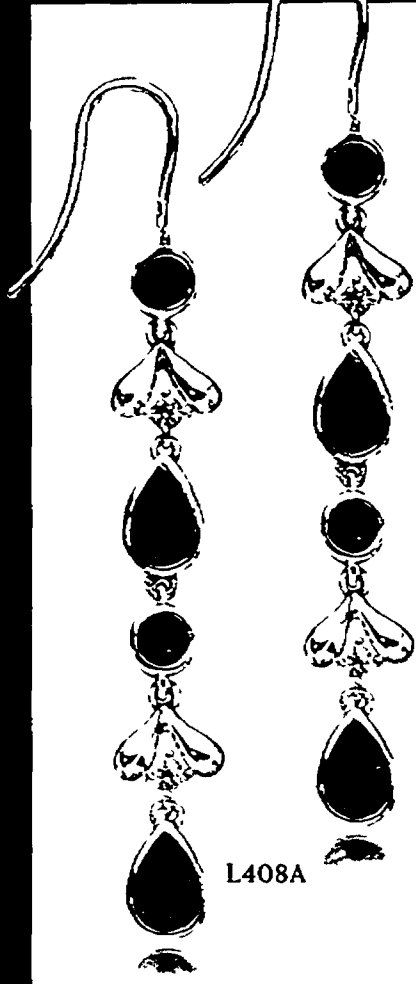

*"Your Family Diamond Store Since 1933  
Celebrating 71 Years of Quality, Integrity, and Style"*

*Orin*  
  
*Jewelers* INC.  
Since 1933



GARDEN CITY  
29317 Ford Road  
at Middlebelt  
734.422.7030

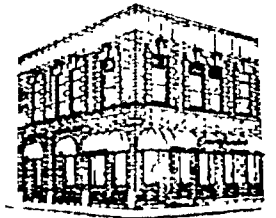

NORTHVILLE  
101 E. Main  
at Center Street  
248.349.6940

[www.orinjewelers.com](http://www.orinjewelers.com)

**FREE Shipping on orders of \$49 or more @ homedepot.com**  
Offer good through 1/5/05. Some restrictions apply.



**You can do it. We can help.™**



**NEW**  
Husky® Quick Change  
Folding Lock-Back Knife  
Includes 5 blades and leather belt pouch.  
**\$14<sup>97</sup>** (354228)



**FREE Laser Level**  
by Mail with Purchase. A \$19<sup>99</sup> Value.

Black&Decker® 12-Volt GelMax™ Drill Kit  
Includes 3/8" drill, (6) 1" screwdriving bits,  
magnetic bit holder, rechargeable battery,  
charger and case. CD120GK (359124)  
**\$49<sup>97</sup>**

**6-in-1  
Roadside  
Companion**

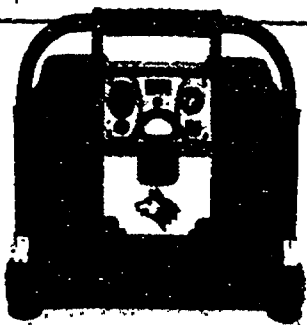

Husky® Portable  
Power System  
Works as 450 AMP jumpstarter, 400 watt  
power inverter, 260 PSI air inflator and  
more. HSK037HD (386989)  
**\$89<sup>99</sup>**

# PERFECT GIFTS

## One Convenient Place



**You Save  
Over \$83<sup>1</sup>**

**\$169**

**18-Volt Cordless Super Combo II**

Includes 1/2" drill with bits, 5-1/2" circular saw with  
carbide-tipped blade, edge guide and wrench,  
reciprocating saw with tool-free blade change and 2  
general purpose blades, Tuff-Sucker™ wet/dry vac with  
crevice tool, brush and squeegee, flashlight, 2  
rechargeable batteries, 1-hour charger and case.

HP518MK2 (200706)  
<sup>1</sup>Total savings based on individual retail  
price of all tools in combo kit.

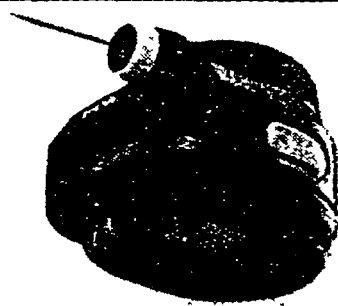

**NEW**  
Ryobi® AIRgrip™  
Laser Level  
Patented, non-marring AIRgrip™ vacuum  
base. Includes mounting pins, 2 AA batteries  
and padded custom case. ELL001 (367457)  
**\$39<sup>96</sup>**

Husky® 1750 PSI  
Residential Electric  
Pressure Washer  
Heavy-duty induction  
motor. 1.6 GPM  
and 36" bayonet  
connection gun/wand.  
Built-in foamer/soap tank.  
**\$169** (360722)



**Visit our Easy to Find  
Location in Midland**

**Grand Re-Opening in Roseville**

**Give the Perfect Gift: The Home Depot Gift Card**



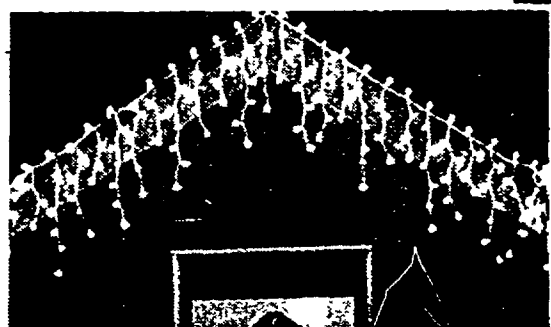

**300 Light Count,  
Icicle Light Set (844071)  
\$487**

**A. 300 Light Count,  
18' Garland Light Cluster  
Clear or Multi. (501336)(507931)  
\$797**

**B. 150 Light Count,  
4'x6' Holiday Net Light  
Clear or Multi. (843476)(842854)  
\$497**

**A. 300 Light Count,  
Miniature Holiday Light Set  
Clear or Multi. (842806)(845973)  
\$486**



**FREE  
How to Clinics**

- **Saturday, Dec. 4, 9am**  
Kid's Workshop:  
Snowman Napkin Holder
  - **Tuesdays 7pm**  
Power Tools 101: You Can  
Try It Before You Buy It
  - **Thursdays 7pm**  
You Can Install a  
Garage Door Opener
  - **Fridays 7pm**  
You Can Install Track Lighting
  - **Saturdays 10am**  
You Can Refinish Furniture
  - **Saturdays 2pm**  
You Can Enhance Your  
Home with Holiday Lighting
  - **Sundays 2pm**  
You Can Have Fun  
with Color and Faux
- No clinics Dec. 24-26, 30 or 31**



**A Variety of  
Artificial Trees To Choose From**

SIZE	13'	9'5"	7'5"	7'	6'5"
VARIETY	Pine	Mountain Spruce	Kodiak Fir	Pine	Oregon Pine
LIGHTS	Clear	Clear	Frosted & Clear	Clear or Multi	Clear or Multi
TIP CT.	4828	2074	2848	1400	750
LIGHT CT.	1900	1000	1000	650	450
SKU	288916	281620	281616	281632, 281626	233045, 281599
PRICE	<b>\$499</b>	<b>\$199</b>	<b>\$149</b>	<b>\$84<sup>96</sup></b>	<b>\$68<sup>74</sup></b>

\*When purchased with your Home Depot Consumer Credit Card. Additional terms apply. See page 30 for details.

# LIGHT UP THE HOLIDAYS

More great values to enjoy for years

48" Deer or Grazing Doe Holiday Yard Ornament  
3D decorative stationary fixture that lights up. Pre-wired with clear lights. (155551) (154829)

**\$3498**

60" Deer or Grazing Doe Holiday Yard Ornament (1332911) (1842958) **\$5998**

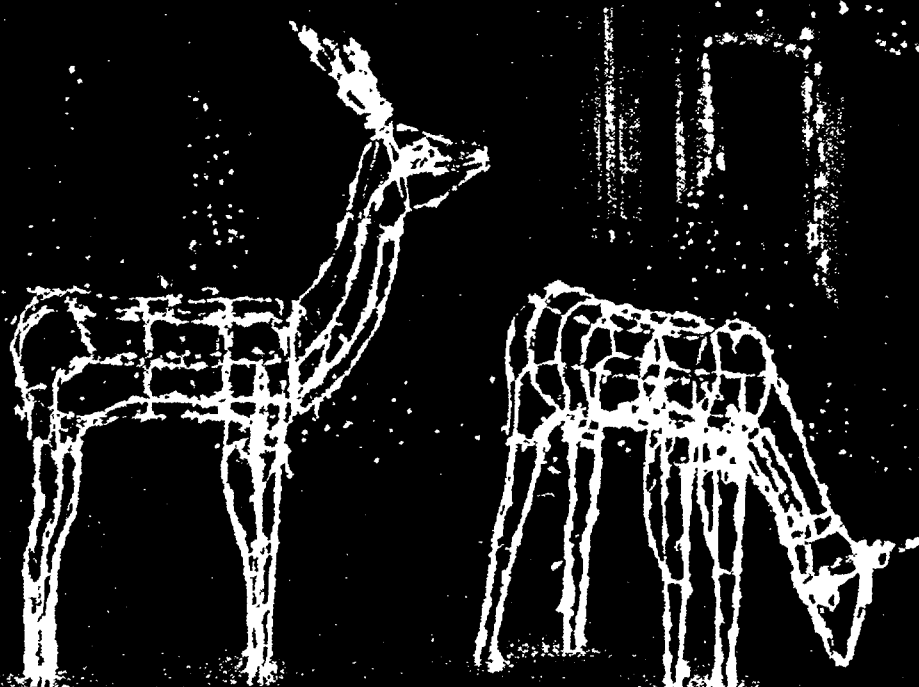

## 8' Inflatable Light-Up Snowman

For outdoor use only. Choose from a Snowman or Santa. Self-inflates with outdoor fan. Fan, light bulbs, yard stakes, stand and tethers included. (341625) (341365)

**\$3782**

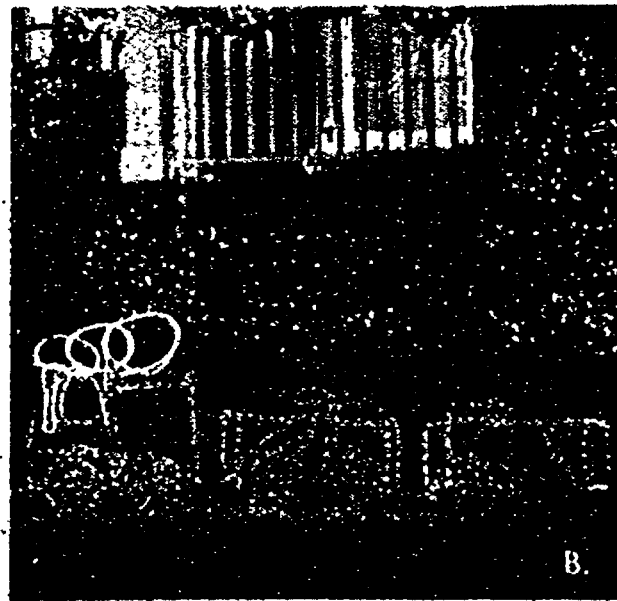

A. 3 Deer with Sleigh Holiday Ornament  
600 lights. Ideal for outdoor display. (285984)

**\$9998**

B. 3D Rope Light Holiday Train  
Train appears running with animated smoke. (305693)

**\$7998**

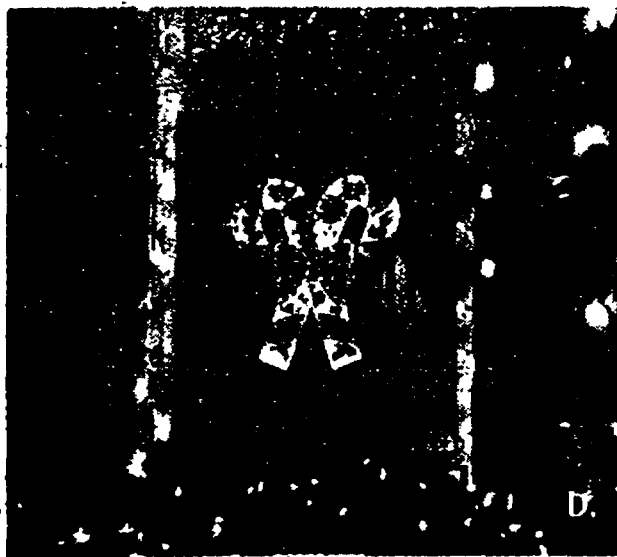
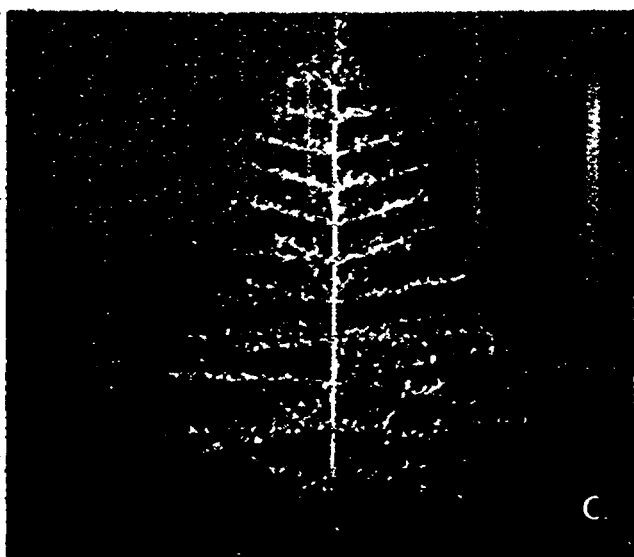

C. 7' Brilliant Tree Holiday Yard Ornament  
3D decorative stationary fixture that lights up. Pre-wired with 1000 clear lights. (186938)

**\$5998**

D. 20" Assorted Holographic Holiday Window Decorations  
Choose from Santa, a candy cane or snowman. (329134)

**\$998**

Product availability may vary by store location.

You can do it. We can help.



812 - 72, 106, 115, 120, 121, 139, 156, 157, 231, 246, 304, 310, 314, 320, 322, 323, 325, 342, 366, 369, 371-1212-4

Saturdays at 2pm

**FREE** How-to Clinic

You Can Enhance Your Home With Holiday Lighting

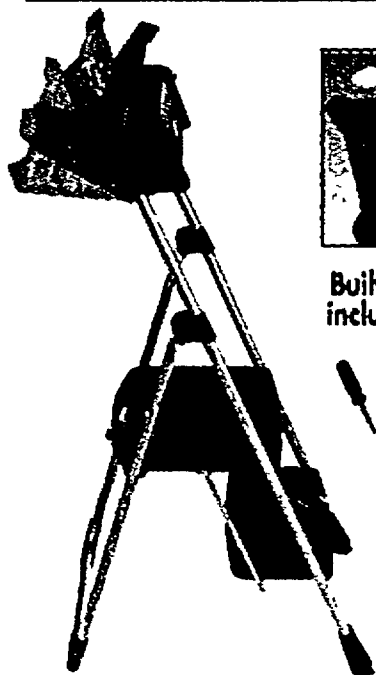

Built-in toolbox includes 5 tools



Lid converts to paint tray with tool holder

**LADDERS**

**NEW 2-Step Project Ladder**  
Bonus tool kit includes 12' tape measure, 8 oz. hammer, 4-1 screwdriver, level, fastener kit.

**\$29** (330886)

**Special Buy**  
**16' Fiberglass Extension Ladder**  
Ideal for builders and electricians. Heavy-duty, non-conductive material. 250 lb. load capacity.

**\$119** (636244)

**24' Fiberglass Type 1A Extension Ladder**  
300 lb. Capacity.

**\$195** (605443)



**EXTERIOR**

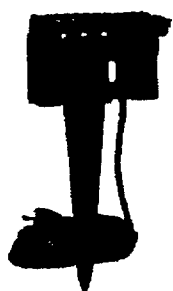

**Green Folding 3-Outlet Stake** (368712)

**\$1297**

**Triple Outlet Stake with Timer** (182208)

**\$1497**



**All-Metal Stake Light**  
Removable stake for wall or ceiling mount.

(786556)

**\$497**

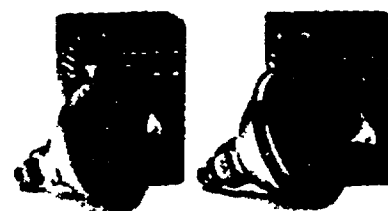

**100 Watt Colortone® Outdoor Flood Red or Green** (267105)(267078)

**\$399**



**50' 16-3 Green Outdoor Extension Cord** (809543)

**\$621**

# HOLIDAY HOOK-UP MADE EASY



**New 3-Flood Light String with 36' Cord**

Accent trees and shrubs, or your house. 10' of cord in between each light. (182197)

**\$1997**



**INTERIOR**



**Basic Plug-In Timer**  
24 hour timer with 2 on/off settings per day. (283122)

**\$495**



**9-Outlet Christmas Tree Cord**  
9' cord. Connects up to 9 strings of lights.

**\$497** (665379)



**9' Green Switch Cord**  
Includes foot switch. Switch plate is an "on" / "off" switch operated with foot.

**\$497** (185684)



**Green Indoor Extension Cords Value Pack**  
Pack includes one of each: 6', 9' and 15' cords.

3 pack **\$497** (185795)



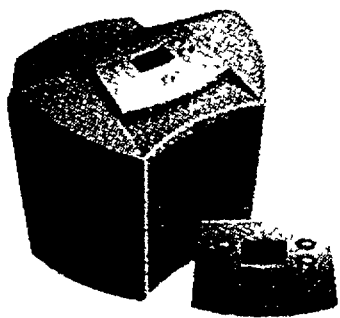

**Holmes**

Ceramic Disc Heater with Electronic Controls Includes remote Sets the temperature where you are in the room.

**\$5997** (404606)

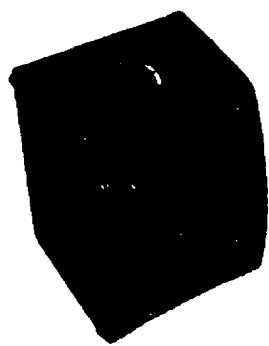

**Holmes**

Ceramic Heater Ceramic element technology. Cool touch housing. 3 year warranty.

**\$1799** (681852)

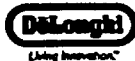

Baseboard Heater Advanced X-shaped element heats air twice for faster, more efficient heating.

**\$5999** (407223)

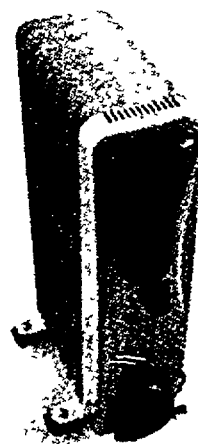

**PELONIS USA LTD.**

Oil Filled Radiator Heater Cool touch housing. Cord wrap. 1 year warranty. 1500 watts/5200 BTU.

**\$3499** (682101)

**Job-Site Heaters**

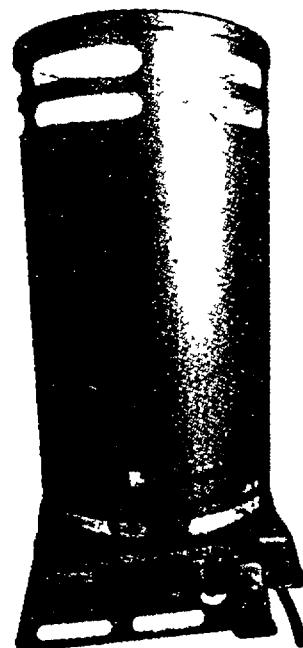

**SPC**

200,000 BTU Convection Propane Heater Compact and lightweight. Pilot light ignition. No electricity required. Hose and regulator included.

**\$119** (659475)

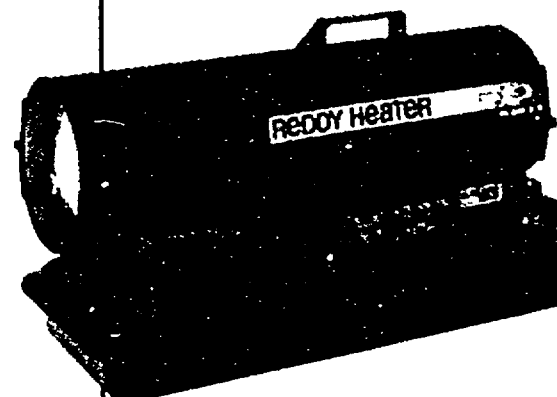

**DESA INTERNATIONAL**

60,000 BTU Kerosene Forced Air Heater Heats up to 1400 sq. ft. 5 gallon tank. Flame-out control system shuts heater down in the event of loss flame or lack of fuel.

**\$179** (415835)



**LASKO**

Widespread oscillation **30" Tower Heater with Remote Control**

All new elevated tower heater quickly circulates warmth where it's needed most - at seated height.

**\$5999** (162874)



**LASKO**

Ceramic Oscillating Tower Heater with Remote Easy-to-use timer promotes energy savings. (452723)

**\$4997**

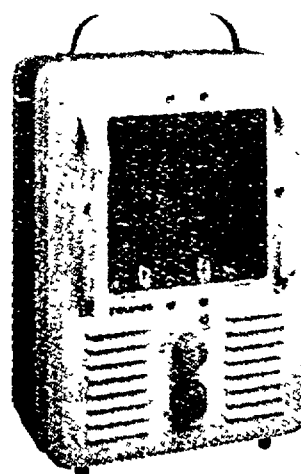

**KING OF FANS**

Workman Utility Heater 1300/1500 watts. Includes two heat settings and one fan only setting. (682105)

**\$1799**

**HEATING INNOVATIONS**

Perfect for any room

Reasonable quantities of stock on hand. Product availability may vary by store. Shop early for best selection. See store for details.

**You can do it. We can help.**



# THE BEST SELECTION



## *Charmglow.*

Select from our full line of mantels, heaters and fireplaces. Redesigned with a decorative flair, they are sure to please the whole family.

### **33" Electric Fireplace with Cognac Cherry Finish Wall Mantel and Base**

4,500 BTUs. Heats up to 400 sq. ft. Built-in thermostat with remote control. 51-1/2"W x 51-1/2"H.

No assembly required. (440641)

# \$699

Only \$22 per month\*



## **Truck Rental**

### **Haul It Home Today**

Rent a truck and take your purchases home today.

The Home Depot® makes it easy to get your supplies and equipment home with easy-driving rental trucks with the convenience of automatic transmissions.

Renting a truck is easy. You pay only \$19 for the first 75 minutes.

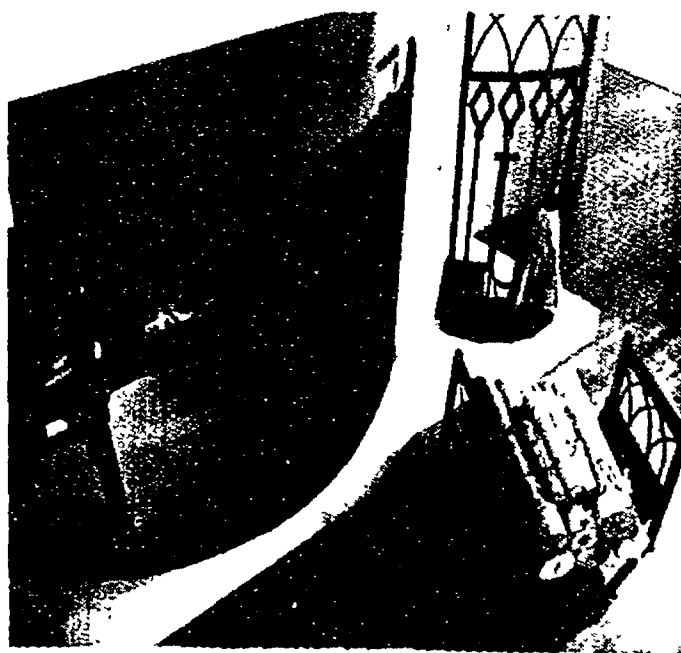

**3-Panel Black Finish Wrought Iron Fire Screen with Deco Frame (440117)**

**\$6998**

**5-Piece Black Finish Wrought Iron Fire Set with Deco Frame (492890)**

**\$4998**

**Black Finish Log Rack (492965)**

**\$3998**



**34" 3-Panel Hammertone Charcoal Finish Fire Screen (207052)**

**\$7998**

**30" 5-Piece Hammertone Charcoal Finish Fire Set (207139)**

**\$6998**

# OF FIREPLACES

Warm Up Your Wish List

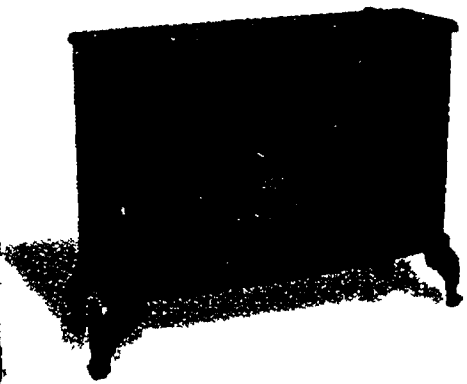

**Vent-Free 30,000 BTU  
Natural Gas Stove**  
Heats up to 1000 sq. ft.  
Hand-painted logs  
included. Cool Touch  
housing. (373591)

**\$299**

Only \$13 per month\*

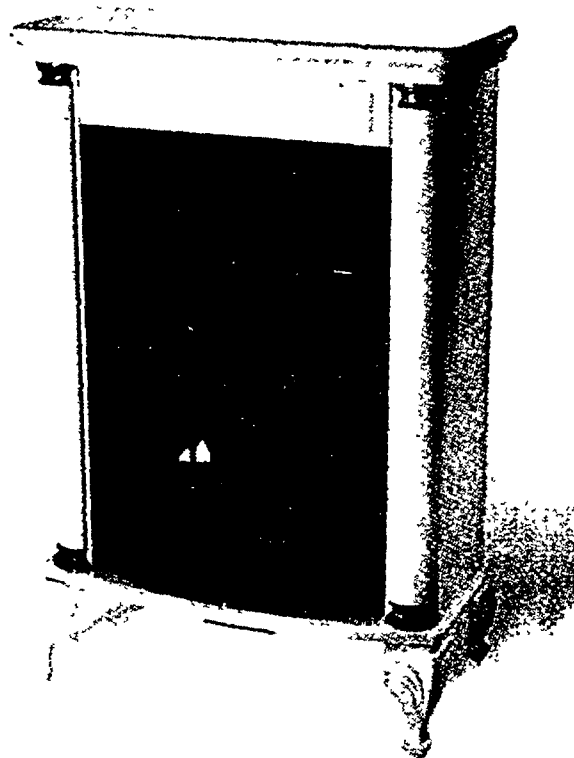

**Vent-Free  
25,000 BTU  
Natural Gas Fireplace**

Heats up to 700 sq. ft.  
Hand-crafted log set included.  
Cool Touch housing. (394782)

**\$349** Only \$13 per month\*

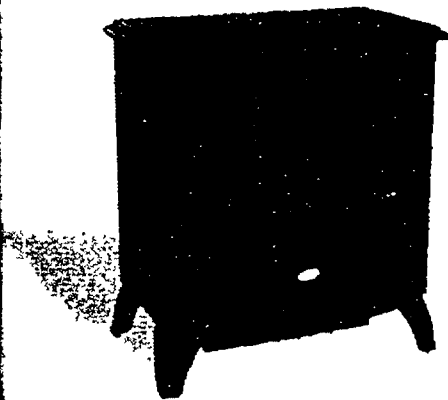

**Classic Electric  
Stove with Heater**  
5,115 BTU. 120 Volts.  
1,500 Watts. (451034)

**\$279**

Only \$13 per month\*

**Compact Electric Stove  
with Heater (409896)**  
**\$179**

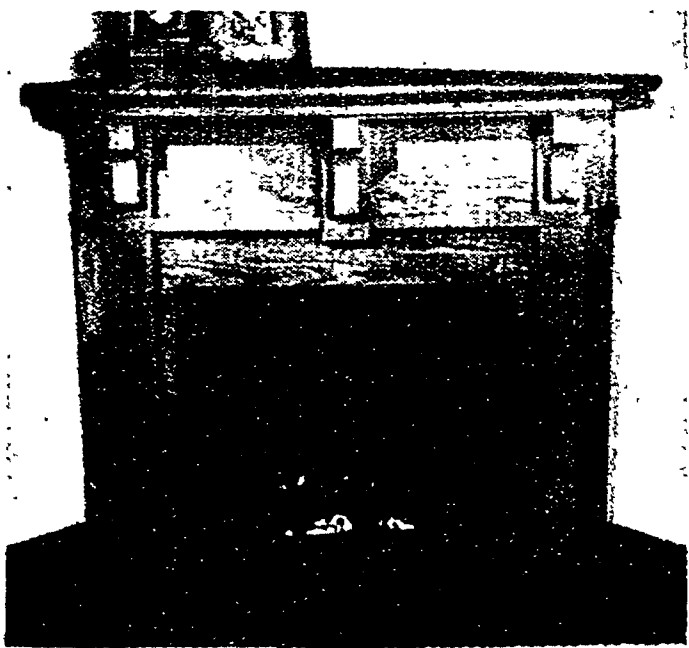

**26" Electric Fireplace with Harvest Oak  
Corner Mantel and Base**  
4,500 BTUs. Heats up to 400 sq. ft. Built-in  
thermostat with remote control. 47-1/4" W x  
46" H. No assembly required. (437223)

**\$589** Only \$19 per month\*

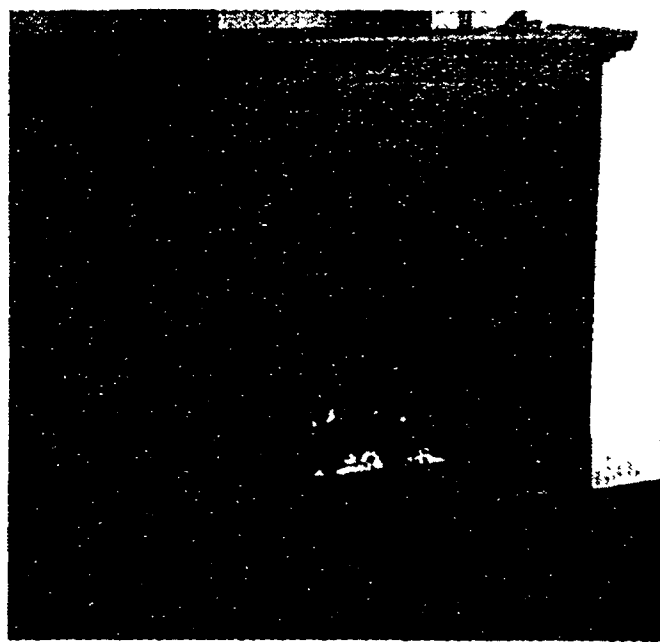

**33" Electric Fireplace with  
Harvest Oak Mantel and Base**  
4,500 BTUs. Heats up to 400 sq. ft.  
Built-in thermostat with remote control.  
51-1/2"W x 48-13/16"H. (437045)

**\$699** Only \$22 per month\*

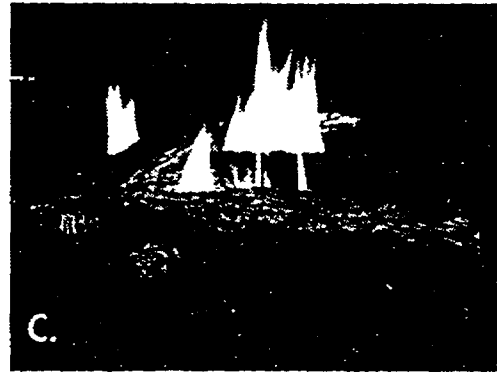
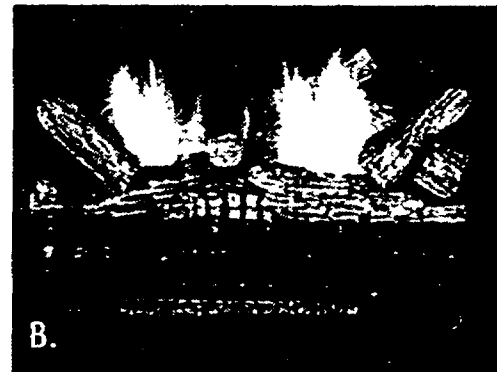
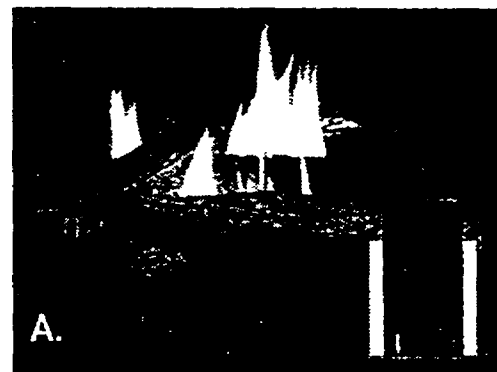

**A. Vent-Free 39,000 BTU  
Natural Gas Log Set  
with Remote Control**  
Dual flame burner.  
5 hand-painted logs. Remote  
control turns unit on/off and  
adjusts flame height. (607193)  
**\$359** Only \$17 per month\*

**B. 18" Rustic Pine Vent-Free  
35,000 BTU Natural  
Gas Log Set**  
Thermostatically controlled  
burner. 99% heat and energy  
efficient. (577547)  
**\$279** Only \$13 per month\*

**C. 21" Split Oak  
Vent-Free 39,000 BTU  
Natural Gas Log Set**  
5 hand-painted logs. (263248)  
**\$199**  
Propane (262634) **\$199**

Product availability may vary by store location.

**You can do it. We can help.**





## Grasp the Power

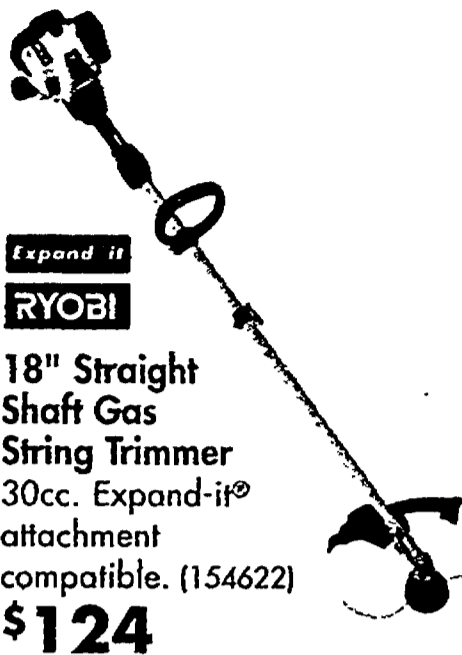

Expand it  
**RYOBI**

**18" Straight Shaft Gas String Trimmer**  
30cc. Expand-it® attachment compatible. (154622)  
**\$124**



**BLACK DECKER**  
**12-Volt, 12" Cordless Trimmer/Edger**  
Automatic feed spool, 0.065" line. (683958)  
**\$89.97**



**Homelite**  
**30cc Vac Attack II® 3-in-1 Gas Blower, Mulcher & Vacuum**  
200 MPH air speed. 420 CFM. (304735)  
**\$99**



**UNION**  
**Wet 'N Dry™ Leaf Rake**  
Effectively rakes both wet and dry leaves. (123511)  
**\$1774**



## Battery-Powered Kid's 2-Speed Gator

17"x26"x6' dumping bed with open tailgate. Working gear shift and horn. 12-volt rechargeable battery and recharger included. (503250)

**\$259**

Only \$13 per month\*



# THE GIFTS THEY REALLY WANT

Shop our huge selection of outdoor ideas

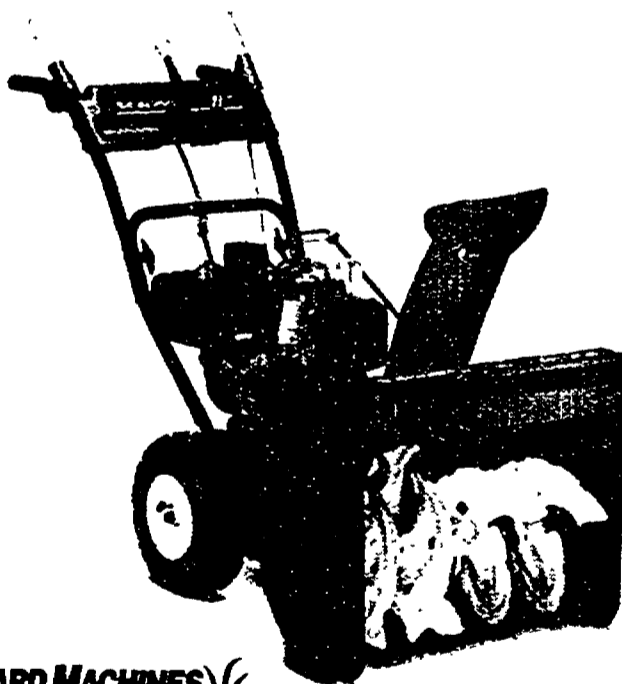

**YARD MACHINES**

## 8 HP 2-Stage Snow Thrower

Tecumseh® 4-cycle engine. Electric start. 24" clearing width. Up to 40' throw distance. 2 year limited warranty. (310468)

**\$699**

Only \$22 per month\*



**5.5 HP 2-Stage Self-Propelled Snow Thrower**  
4-cycle Tecumseh engine. 6 forward/2 reverse speeds. 20" clearing width. Up to 35' throw distance. (399315)

**\$599** Only \$19 per month\*

**TORO**

**7.5 AMP Power Shovel Plus Electric Snow Thrower**  
Multi-functional — clears snow and other debris. 12" clearing width. Up to 20' throw distance. (407979)

**\$119**



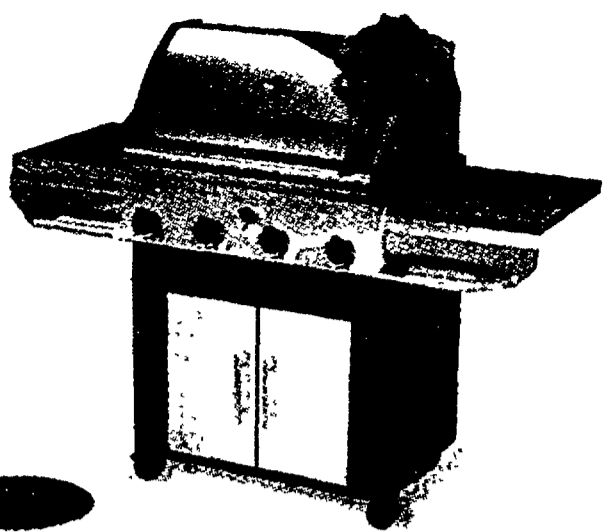

**Vermont Castings® 48,000 BTU Gas Grill**  
450 sq. in. primary cooking surface.  
160 sq. in. warming rack. 610 sq. in.  
total cooking surface. (418495)

**\$599** That's only **\$19** per month\*



**Vermont Castings® 36,000 BTU Gas Grill**  
400 sq. in. primary cooking surface. 120 sq. in.  
warming rack. 520 sq. in. total cooking surface.  
Porcelain cast-iron cooking grates. (418306)

**\$398** That's only **\$17** per month\*

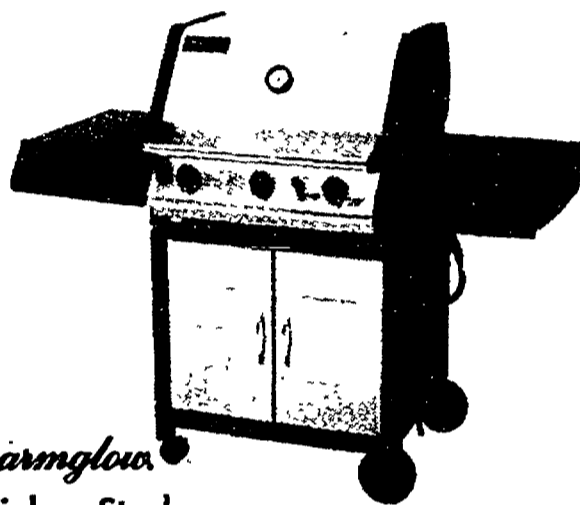

**Charmglow**

**Stainless-Steel  
45,000 BTU Gas Grill with Side Burner**  
492 sq. in. primary cooking surface.  
144 sq. in. warming rack.  
12,000 BTU side burner. (583591)

**\$299** That's only **\$13** per month\*



**Char-Broil**

**QuickSet®  
40,000 BTU Gas Grill**  
405 sq. in. primary cooking surface.  
510 sq. in. dual swing-away warming rack.  
915 sq. in. total cooking surface. (596039)

**\$169**

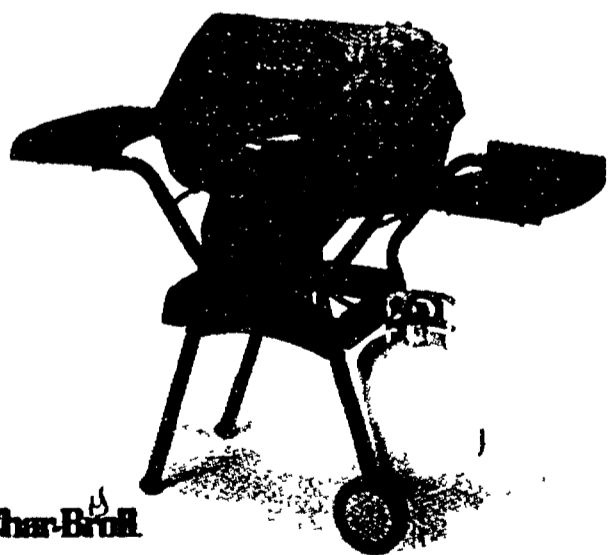

**Char-Broil**

**QuickSet® Cast  
Aluminum 35,000 BTU Gas Grill**  
340 sq. in. primary cooking surface. 240 sq.  
in. single swing-away warming rack. (623676)

**\$139**

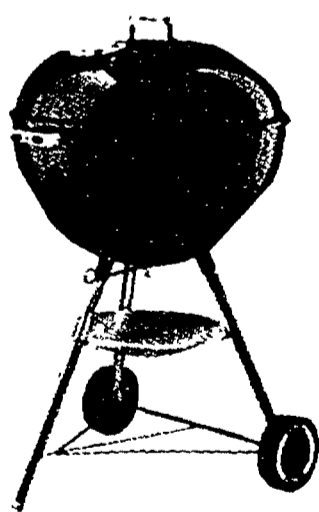

**weber**

**22.5" One-Touch®  
Silver Charcoal Grill**  
22.5" diameter cooking surface.  
Triple nickel-plated cooking grate. (682576)

**\$7970**

## Grill Accessories

**Charmglow**



**Stainless-Steel  
Electric Turkey Fryer**

No open flame. Thermostatically  
controlled. 28 qt. aluminum pot.  
Use to fry, steam or boil.  
Safety shutoff. (380894)

**\$9998**

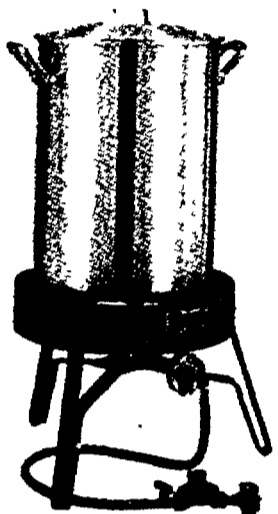

**7-Piece  
30 Quart  
All Purpose  
Turkey Fryer**

Steam/boil/fry. Accommodates  
up to an 18 lb. turkey. Perfect  
for boiling corn, cooking stew  
or chili. (680865)

**\$4998**



**3 Gallon  
Premium  
Quality  
Peanut Oil**  
100% pure  
peanut oil.  
(336173)

**\$2396**

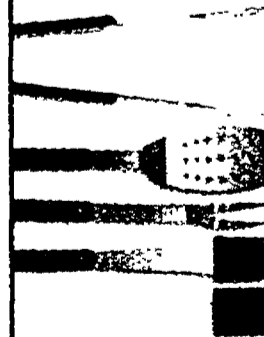

**4-Piece  
Stainless  
Steel BBQ  
Tool Set**  
(481375)

**\$1998**

Product availability may vary by store location.

**You can do it. We can help.**



72,101,64,67,106,115,120,127,131,139,143,156,157,158,164,169,185,206,207,208,235,237,246,247,262,276,288,300,304,310,314,317,320,322,323,325,342,366,369,371,382,383,391,12724

# YOUR SOURCE FOR THE BEST TOOLS

Just right for every budget

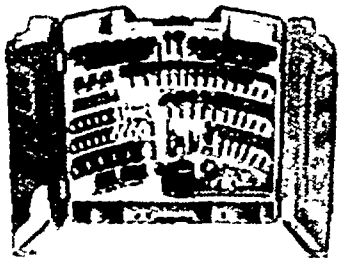

New Lower Price Dremel®  
220-Piece Mega Accessory Kit  
**\$29<sup>97</sup>** was \$34<sup>99</sup>  
(400217)



Special Buy Ryobi® 150-Piece  
Mega Mat Drilling  
and Driving Set  
**\$39<sup>97</sup>** A981501 (307492)

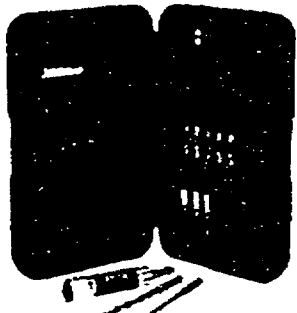

40-Piece Fast Change  
Drill/Drive System™  
**\$29<sup>97</sup>** (141649)



Special Buy  
Black & Decker® 129-Piece  
Accessory Set  
**\$19<sup>97</sup>** 71-999 (332338)



## Dremel 400 Series XPR™ Deluxe Rotary Tool Kit

Includes high performance rotary tool, XPR™ planer attachment, cutting guide attachment, flex-shaft attachment, lawn mower/garden tool sharpening attachment, 70 accessories and a deluxe XPR™ storage case with 2 removable accessory set to store 2 more. 400-4/70H (311258)

400 Series XPR™ Rotary Tool Kit **\$79<sup>97</sup>** 400-4/41H (310992)

**\$99<sup>99</sup>**

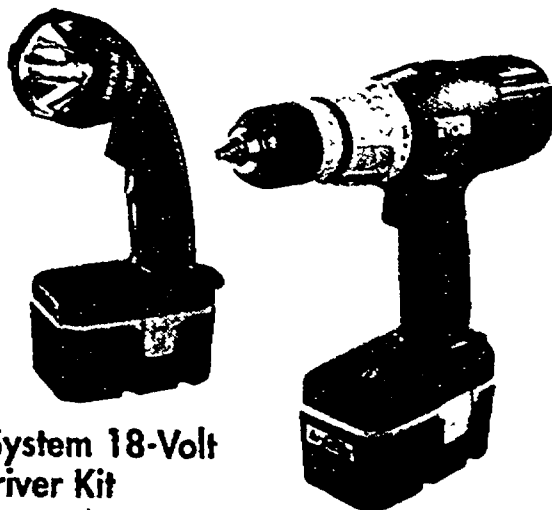

## One+ System 18-Volt Drill/Driver Kit

Includes 2 rechargeable batteries, 1-hour charger, 2 double ended bits, flashlight and case. Mag Tray™ magnetic storage tray for quick access to your driving bit.

**\$89<sup>97</sup>** (338116) P810

FREE Laser Level by  
mail with Purchase.  
See store for details.



## Black & Decker GelMax™ 18-Volt 4-Tool Combo Kit

Includes drill with bit storage, random orbit finish and detail sander, powered hand saw, hand vac, 2 rechargeable batteries, charger, magnetic bit-tip holder, (6) 1" bits, 3 blades, 10 sanding accessories and a tool bag.

**\$149** BDGC418B2 (219730)



Integrated light  
and tape  
measure



**Black & Decker® 6-Volt  
Pivot Plus™ Screwdriver**  
High-speed for drilling holes and  
low-speed for driving screws.  
**\$29<sup>66</sup>** PD600 (165861)



**Ryobi® 7.2-Volt Drill Kit**  
**\$29<sup>97</sup>** HP472K (756950)

**Ryobi® 9.6-Volt Drill Kit**  
**\$39<sup>97</sup>** HP496K (334725)

Free \$10 Gift Card by  
Mail to The Home Depot®

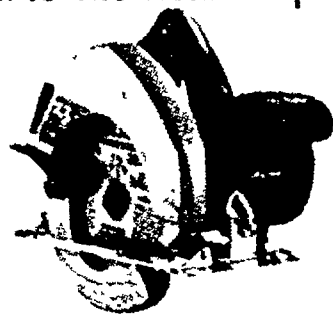

**Skilsaw® 7-1/4" Circular Saw**  
12 AMP, 4600 RPM. 2-point line  
of sight for straighter cuts. Safety  
lock-off reduces accidental starts.  
**\$38<sup>66</sup>** 5400-01 (343803)

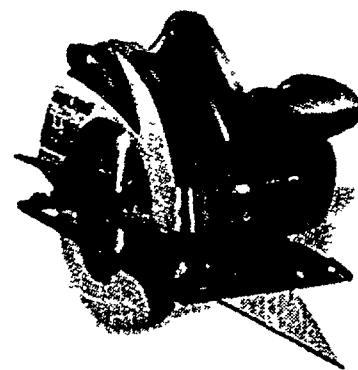

**Skilsaw® with Laser**  
Laser guidance makes cutting  
straight lines easier. 18-tooth  
carbide blade and case.  
**\$79** 5750-01 (382238)

**YOUR  
CHOICE  
\$87**  
was \$99  
or more

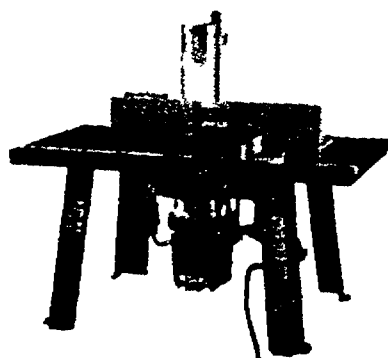

**Ryobi® Router Table Combo**  
R161RTA (402114)

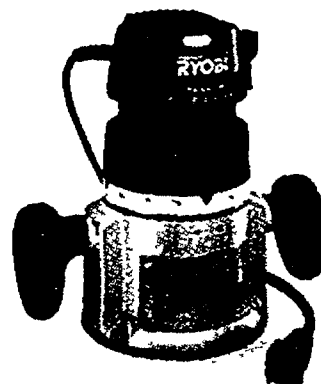

**2 HP 3-Base Router Combo**  
RE1803BK (314829)

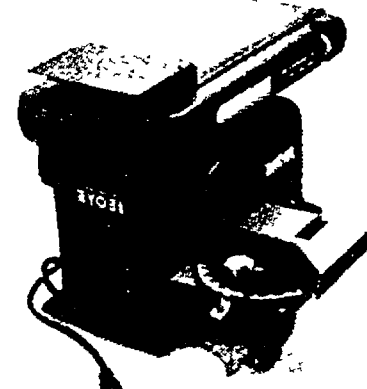

**Ryobi® 4"x36" Belt  
and 6" Disc Sander**  
BD4600 (281657)



**Ryobi® 10" Table  
Saw with Stand**  
BTS10S (418826)

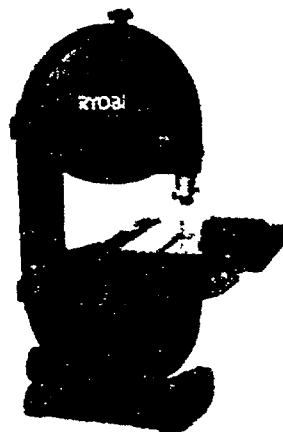

**Ryobi® 9" Precision  
Bench Top Band Saw**  
BS902 (496766)



**Ryobi® 10" Compound  
Miter Saw**  
TS1340 (179469)

**Skil® 18-Volt XDrive™ 6-Tool Combo Kit**

Includes drill with auxiliary handle, full-sized 7-1/4"  
Skilsaw® with laser guidance and 18-tooth carbide  
blade, reciprocating saw with 6" wood-cutting blade,  
flashlight, stud finder, laser level,  
bit size index, 2 rechargeable  
batteries, 1-hour charger  
and heavy-duty  
carrying bag.  
2887-17 (179911)

**\$187**

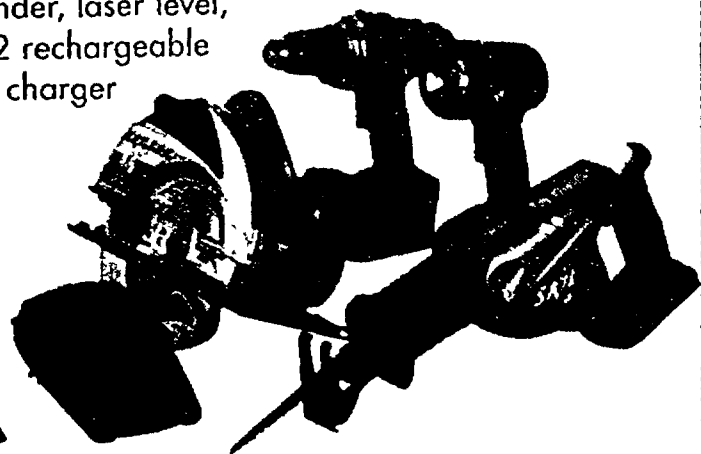

**Ryobi® "The Works" Cordless 18-Volt, 8-Piece Combo Kit**

Includes 1/2" drill, reciprocating saw, 5-1/2" circular saw  
with blade, jigsaw, chainsaw, flashlight, sonic measuring  
device, Tuffsucker™ wet/dry  
vac with tools, 28-piece bit  
set, 2 rechargeable-  
batteries, 1-hour  
charger and rolling  
duffle bag.

MK618K3  
(167144)  
**\$249**  
Only \$10  
a month\*



Product availability may vary by store location

**You can do it. We can help.**



Exclusively at The Home Depot®



**NEW RIDGID® 12-Volt Cordless Right Angle Impact Driver**

Compact right angled head that allows for close-quarters operation. R82233 (407459)

**\$169**



**Milwaukee Sawzall® Kit**

10 AMP. 3/4" blade stroke 2,800 strokes per minute.

**\$119** 6509-22 (132734)

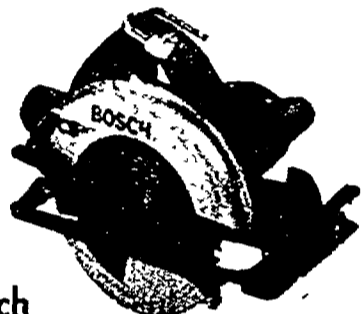

**Bosch 7-1/4" Sidewinder Circular Saw**  
Features DirectConnect™ that puts an end to costly cord cuts and pullouts

**\$139** CS20-XCB (556672)



**Special Buy**

**NEW EDITION**

**Home Improvement 1-2-3 Book**

Complete new edition with new products, new tools, new technologies and even a new chapter on HVAC.

(120423)

**\$1497** was \$1997

**RIDGID® 18-Volt X2™ 4-Piece Combo Kit**

Includes 1/2" hammer drill with auxiliary handle, depth-stop rod and screwdriver bit; reciprocating saw with 2 blades; 6-1/2" circular saw with 18-tooth carbide blade and edge guide; flashlight with bulb; 30-minute dual-port charger, 2 batteries and a contractor bag. R922 (369977)

**\$449** Only \$17 a month\*

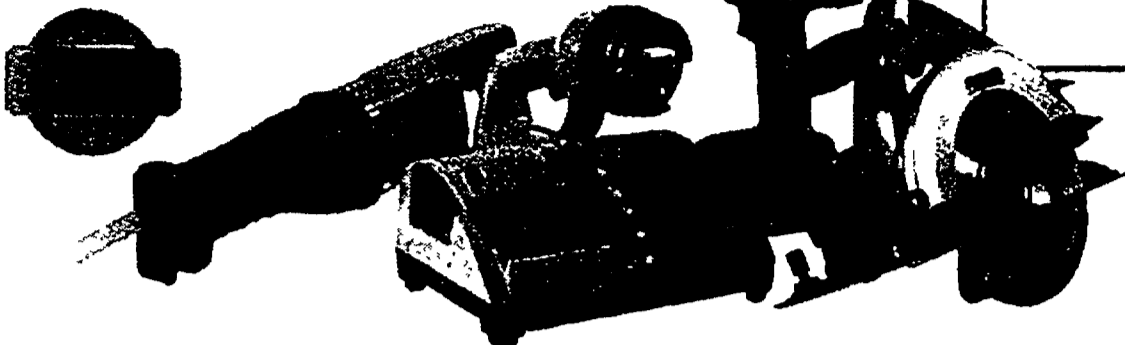

**Free Cordless Jigsaw AND Battery**

by mail with purchase. A \$278 value. See store for details



**No Downtime Guarantee!**

**Milwaukee® 18-Volt Lok-Tor™ Combo Kit**

Includes Hatcher™ Sawzall® with blade and a 6-position pivoting handle, 6-1/2" circular saw with 48-tooth blade, 1/2" hammer drill with side-handle, work light, 2 rechargeable batteries, charger and contractor bag. 0923-29 (284919)

**\$449** Only \$17 a month\*



**FREE 3-Bay Charger or Job-Site Radio**

by mail with purchase. Up to a \$160 value. See store for details.

**DeWalt® 18-Volt XRP™ 4-Pack Combo Kit**

Includes 1/2" hammer drill with 360° side handle and screwdriver bit, 6-1/2" circular saw with blade and rip fence, reciprocating saw with toolless blade change, heavy-duty flexible floodlight, 2 rechargeable XRP™ batteries with 1-hour charger and case. DC4KITA (371918)

**\$499**

Only \$16 a month\*

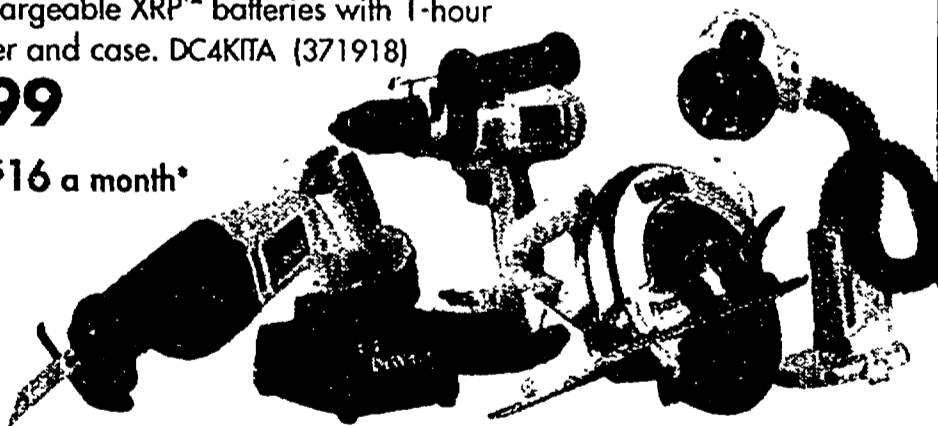

**Buy DeWalt® 6-Tool Kit, get 1 extra bare tool.\*\* Choose from 6 tools, up to a \$150 Value**

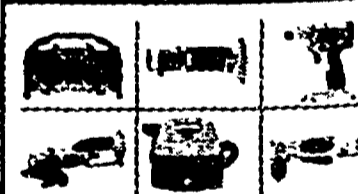

\*\*Via Manufacturer's Mail-in Rebate. See store for details.



**16-Piece Pilot Drill Bit Set**

**\$2497**

DW1956 (801670)

**FREE 23-Pc Screwdriving Set††**



**Bosch® 20-Piece Titanium Drill Bit Set**

**\$2994**  
61120 (153442)

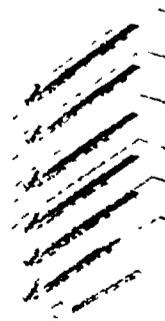

**Milwaukee® 7-Piece Blade Assortment**

**\$1797**  
49-22-1126 (789895)

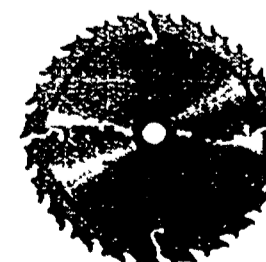

**RIDGID® 7-1/4 24-Tooth Framing Saw Blade**

**\$1297**  
R0724B (588791)

\*When purchased with your Home Depot Consumer Credit Card. Additional terms apply. See page 30 for details. ††By mail with purchase of 61120, a \$15 value. Offer valid until December 31, 2004. See store for details.

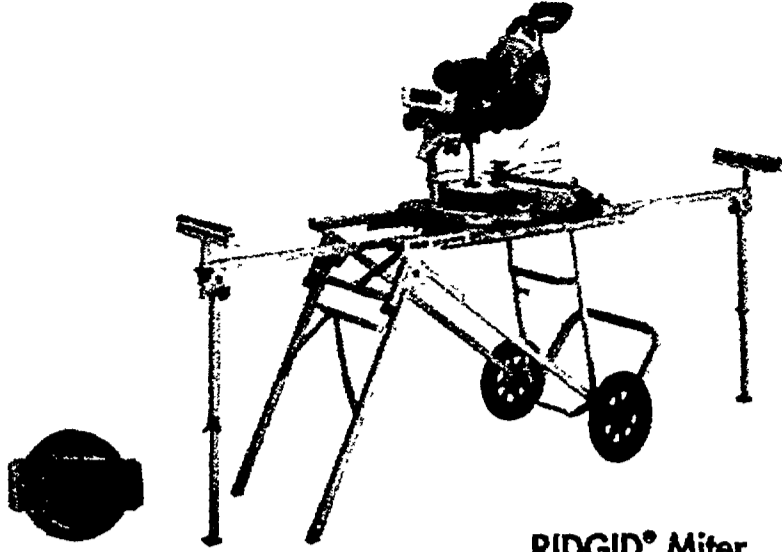

**RIDGID® 12" Sliding Dual Compound Miter Saw**  
Exactline™ laser alignment system for cutting accuracy.  
**\$569** MS1290LZ (295598)  
Only \$19 a month\*

**RIDGID® Miter Saw Utility Vehicle**  
Unfolds quickly, rolls around easily and can be stored vertically - without removing the saw.  
AC9940 (206676)  
**\$149** was \$199

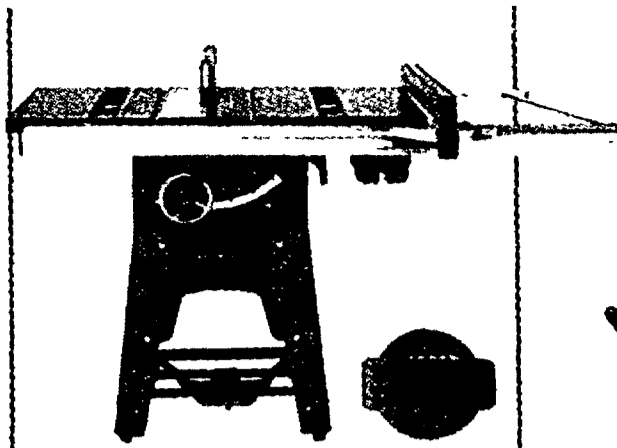

**RIDGID® 10" Cast Iron Table Saw**  
Totally enclosed fan cooled motor. Cab forward design.  
**\$569** TS3650 (105495)  
Only \$19 a month\*

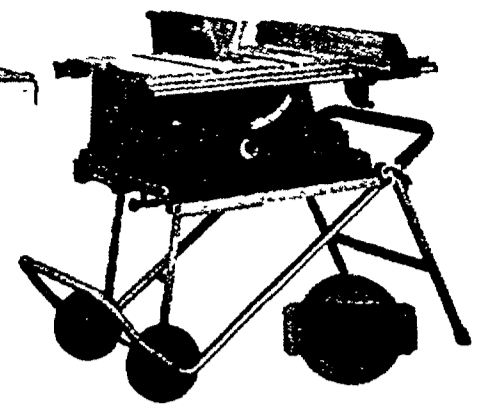

**RIDGID® Heavy-Duty 10" Portable Table Saw with Stand**  
15 AMP universal motor with soft start and overload reset.  
**\$499** TS2400LS (428833)  
Only \$16 a month\*

# AMERICA'S LARGEST TOOLBOX

The best place for the best brands

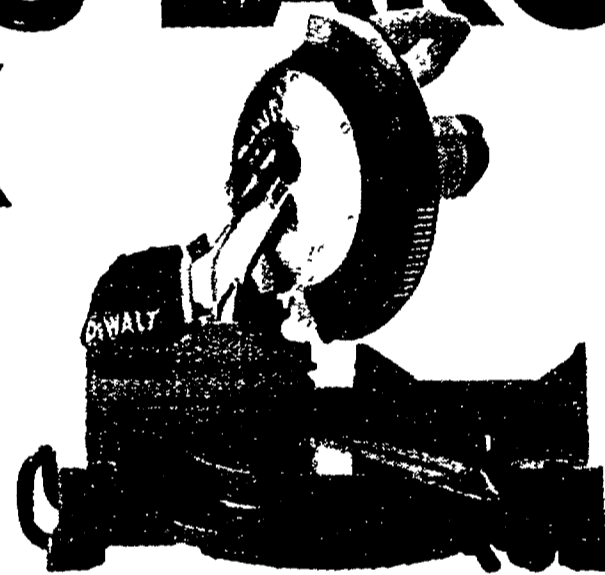

**\$50 Gift Card! to The Home Depot!**

**DeWalt® 12" Compound Miter Saw**  
15 AMP. Long-life stainless steel miter scale. Light-weight.  
**\$299** DW705S (771401)  
Only \$13 a month\*

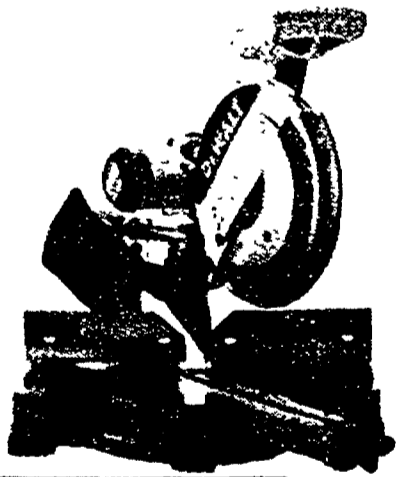

**\$75 Gift Card! to The Home Depot!**

**DeWalt® 12" Sliding Compound Miter Saw**  
15 AMP, 4000 RPM. Meters 50° to the left and 60° to the right.  
**\$599** DW708 (104389)  
Only \$19 a month\*

Buy DeWalt® 6-Tool Kit, get 1 extra bare tool.\*\* Choose from 12 tools, up to a \$250 Value



\*\*Via Manufacturer's Mail-in Rebate. See store for details.

**DeWalt® 18-Volt XRP™ 6-Tool Combo Kit**

Includes reciprocating saw with blade; hammerdrill with 360° side-handle and screwdriver bit; Circular saw with carbide blade and rip fence; impact driver; cut-off tool with side handle, depressed center wheel, type one cutting wheel, spanner wrench, 2 guards and matched flanges; flexible floodlight with 2 bulbs; 1-hour charger; 2 XRP™ rechargeable batteries and a contractor bag DC6KTGA (363136)

**\$599** Only \$19 a month\*

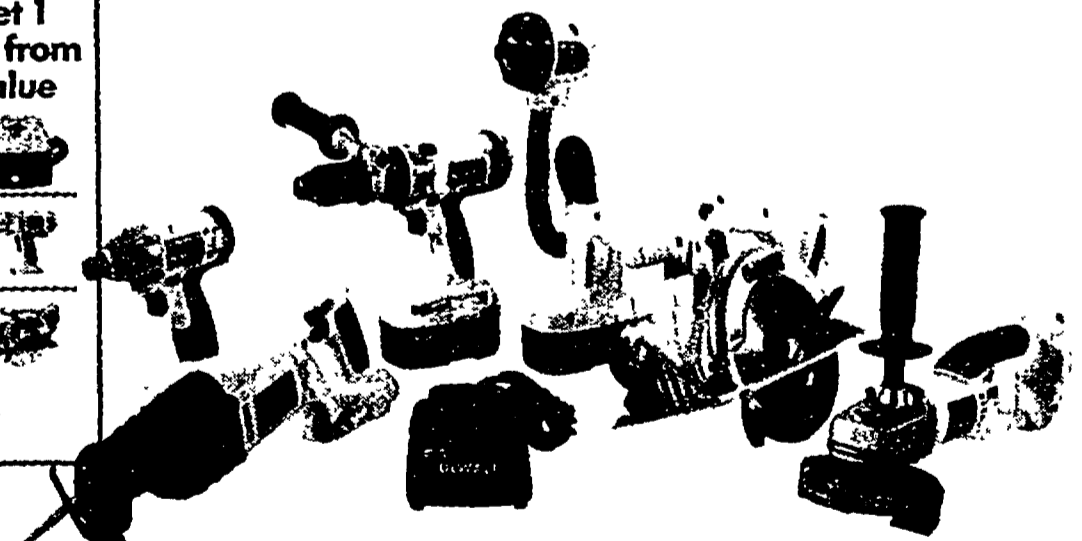

Product availability may vary by store location.

**You can do it. We can help.**



\*by Mail with Purchase. Offer valid 9/1/04 to 12/31/04



# IDEAL GIFTS FOR EVERYONE'S LIST

Case Included

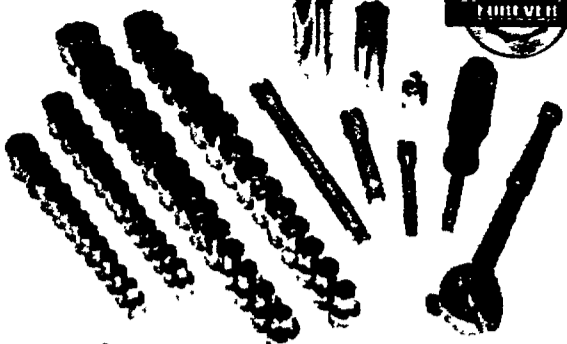

**Husky 60-Piece  
Ratchet and Socket Set**  
Polished chrome vanadium  
finish. Roundhead ratchet.

**\$39<sup>96</sup>** 64715 (172381)

Case Included



**Husky 90-Piece PRO  
Mechanic's Tool Set**  
Black chrome finish  
with high-visibility  
laser etched markings.

**\$139** 64717 (166119)

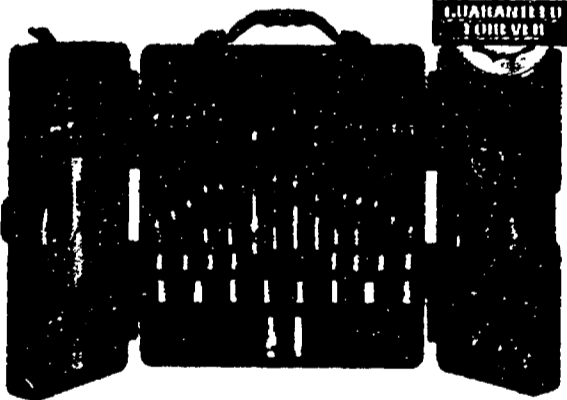

**Husky 160-Piece Tool Set**  
Includes hex key set, 16 oz. hammer,  
4-piece plier set, 8" adjustable  
wrench, utility knife, 44-piece driver  
bit set, 25' measuring tape, multi-  
position ratcheting screwdriver, 5  
screwdrivers, 10 combination wrench-  
es, 53-piece socket and ratchet set, 2  
storage trays and case.

**\$79<sup>96</sup>** 64721 (381576)



Includes 150-Piece  
hand tool and  
socket set



**Husky<sup>®</sup>  
6-Drawer  
Combo with  
150-Piece Mixed Tool Set**

Large storage capacity. Casters with brakes.  
91703/91843WT (477956)

**\$219**

Only \$10 a month\*

**Storage Gifts**

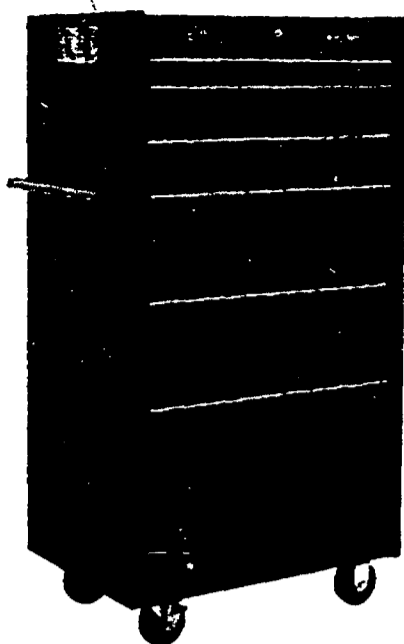

**Husky® 6-Drawer Tool Tower**  
Ball bearing drawers that can support heavy loads. Also available in pewter and orange through special order.  
92-2752-6 BK (526558)

**\$299**

Only \$13 a month\*



**Husky Heavy-Duty Pro Tool Bag**

Constructed of heavy-duty, water resistant SpunTuff™ material.

**\$3497** 45121 (412997)

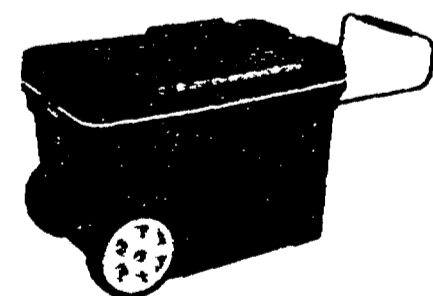

**Stanley® Mobile Contractor Chest**

Pull along tool box with easy rolling wheels and sturdy retractable handle.

**\$2996** 33023 (136684)

Utilizes 5/8" to 1-1/4" brad nails



**Arrow® 1-1/4" Heavy-Duty Electric Brad Nail Gun**  
Powerful 14 AMP and 10' cord.  
**\$5996** ET200 (297431)

Includes 10" curved jaw and needlenose



**Irwin® Vise-Grip® 2-Piece ProTouch™ Locking Pliers Set**  
Rubberized ProTouch™ grip.  
**\$1997** 77SG (110147)

Shock absorbing Endcaps

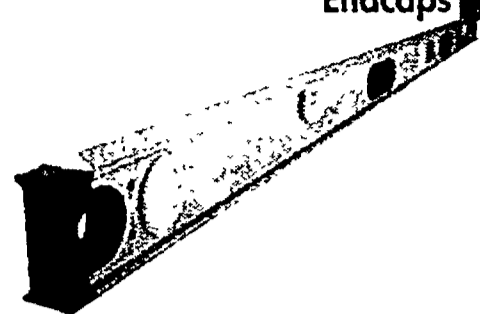

**Stanley® 72" FatMax™ Level**  
Aluminum structure for increased durability.  
**\$4496** 43-507 (310883)



**Stanley® Pro Stud Sensor and Tape Measure Combo**  
LED panel for depth indication.  
**\$2999** 90-708L (594722)

Includes 24-compartment organizer



**WorkForce® 50-Piece Home Tools'n Tote Set**  
Everything you need in a tote.  
**\$2497** 82045 (371173)

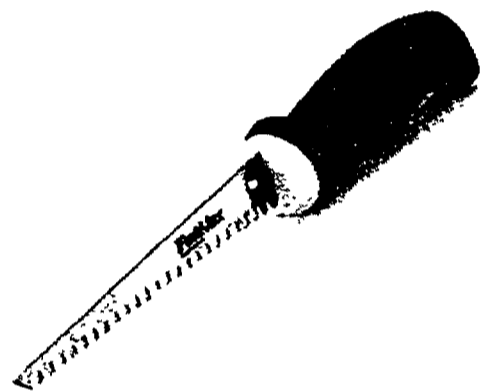

**Stanley® FatMax™ Jabsaw with Sheath**  
SharpTooth™ technology.  
**\$1299** 20-556A (796981)



**Strait-Line® 3-Piece Laser Set**  
Advanced tools to level, measure and locate. Includes 120' laser level, laser targeted sonic tape and accurate stud finder.  
**\$6997** 6045700 (185005)



**Strait-Line® 300' Rolling Tape**  
Measuring device simply rolls on surfaces to measure in 1/16" increments.  
**\$3497** 6041400CD (184397)

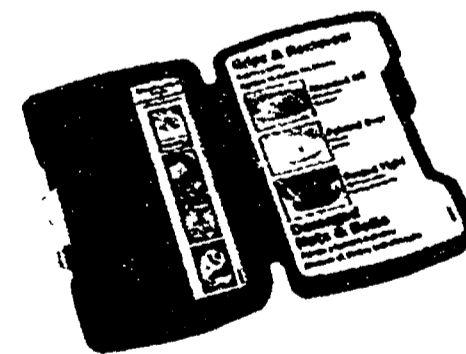

**Irwin® 5-Piece Bolt-Grip™**  
Grips and Removes rounded off, painted, rusted or damaged nuts and bolts.  
**\$1996** 394001 (437724)

Product availability may vary by store location.

**You can do it. We can help.**



# GIFTS MADE EASY

Surprise them with  
the perfect gifts



**THE HOME  
DEPOT GIFT  
CARD**, the  
perfect fit for the  
Do-It-Yourselfers  
on your list

Only at The Home Depot®

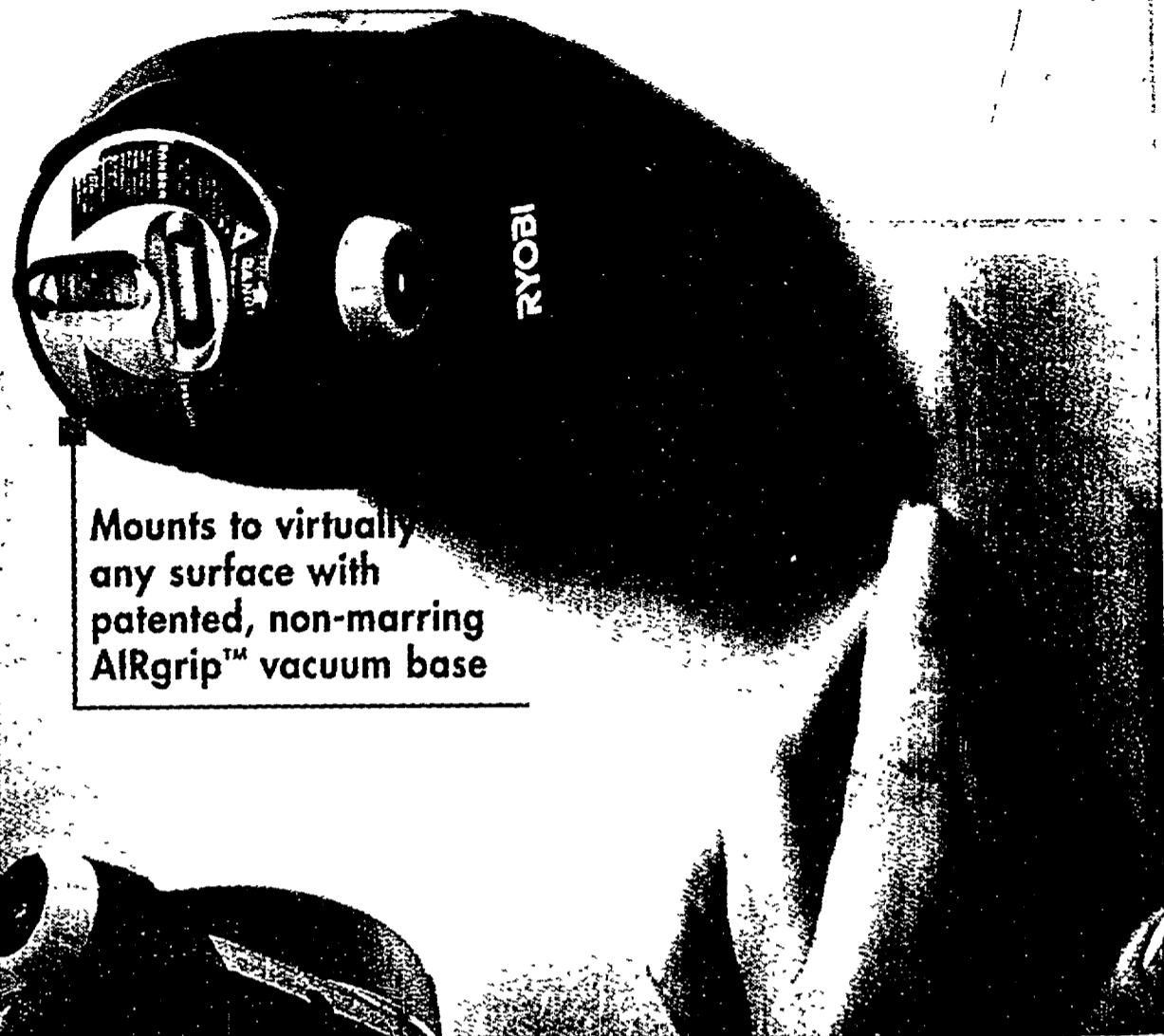

Mounts to virtually  
any surface with  
patented, non-marring  
AIRgrip™ vacuum base

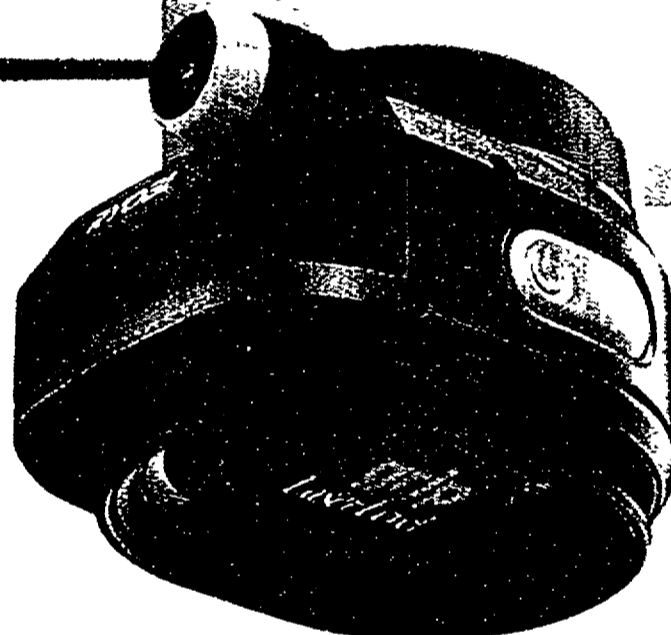

**NEW Ryobi® AIRgrip™ Laser Level**  
360° multi-directional rotating head with a 90°  
rotating lens great for level, plumb and angle  
use. Multi-use base with ability to mount base on  
tripod, secure to objects with straps or use  
mounting pins to secure to objects vacuum base  
will not operate on. Includes mounting pins,  
2 AA batteries and padded custom case.  
**\$39.96** ELL001 (367457)

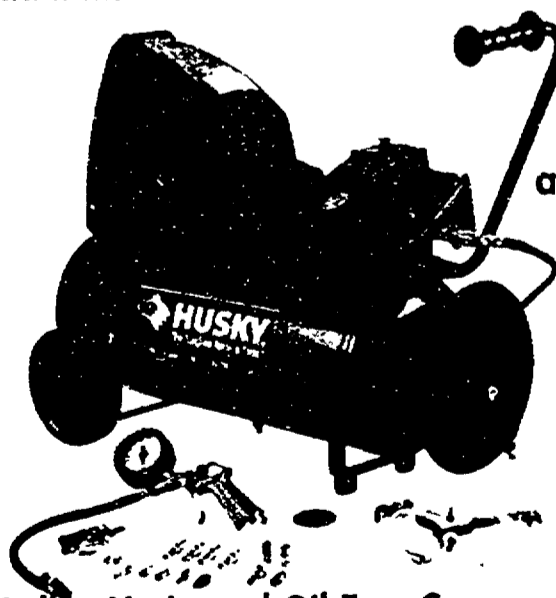

Includes  
21-Piece  
accessory Kit

**Husky® 8-Gallon Horizontal Oil-Free Compressor Kit**  
Powerful 2.75 Peak HP/1.5 Running HP motor. Integrated hose reel with  
16' hose.

**\$169** H27508UWK (171307)

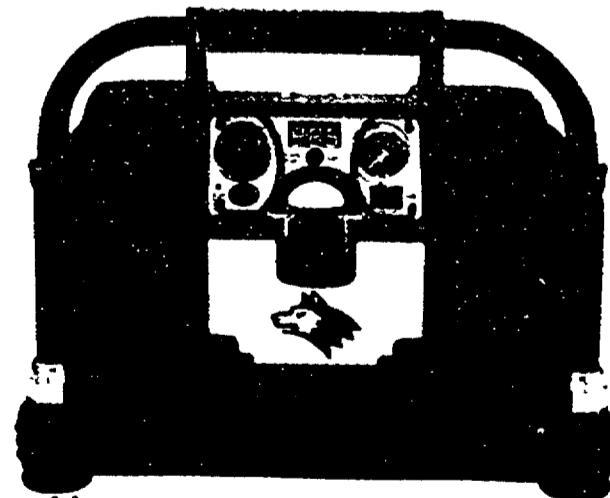

**Husky® Portable Power System**  
Works as 450 AMP jumpstarter, 400 watt power inverter, 260  
PSI air inflator, 12-volt power outlet, 3 LED area light and 120-  
Volt AC quick charger.

**\$89.99** HSK037HD (386989)



### Husky® SwitchGrip™ Dual Jaw Plier Combo

Ergonomic grips for comfort and performance. Spring-loaded jaws with locking handles. Forged chrome nickel jaws with precision machined teeth and cutting edges. 60155 (289009)

**\$10<sup>96</sup>**

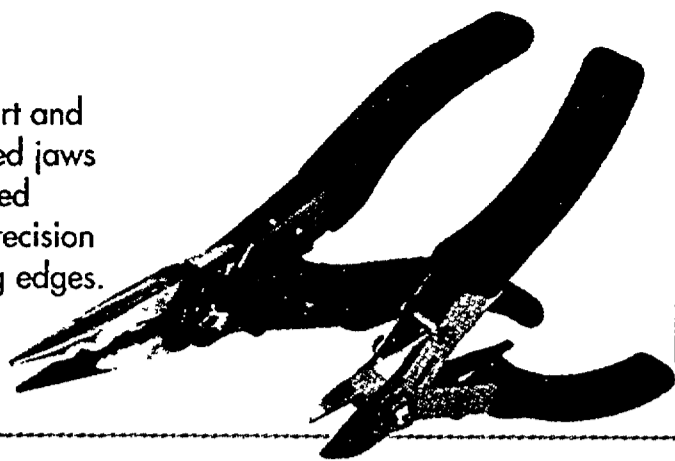

### Husky® Quick Change Folding Lock-Back Knife

Cuts vinyl tile, wallboard and auto hoses; trims carpet. Stainless steel mechanism. Aluminum handle with extra blade storage for 5 blades.

**\$14<sup>97</sup>** 12120 (354228)



Includes 5 blades  
and leather belt pouch

### Husky® Multi-Tool and Knife Combo

Includes 8-in-1 multi function pocket tool and a folding lock-back utility knife. Both with wooden handles and brass bolster.

**\$19<sup>96</sup>** 12816 (586054)

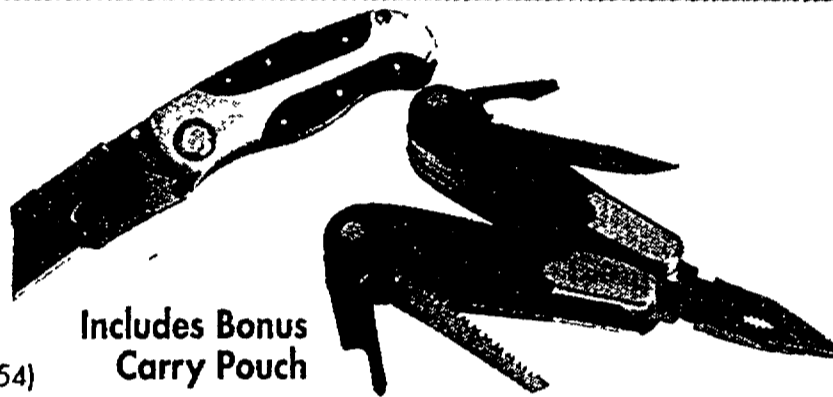

Includes Bonus  
Carry Pouch

### Husky® Easy Air To Go™ Fully Shrouded Compressor

Telescoping handle and wheels for easier mobility. 135 max PSI and 2.0 SCFM @ 90 PSI provides enough air for tasks such as brad nailing, paint spraying, inflation and many others. Y1010 (496555)

**\$119**



Also  
includes  
new  
deflation  
feature  
and kit

## Great Stocking Stuffers

### Husky® Cordless Rechargeable Spotlight

1-million candle power with 3-position control dimmer. HSK117S (331623)

**\$22<sup>97</sup>**

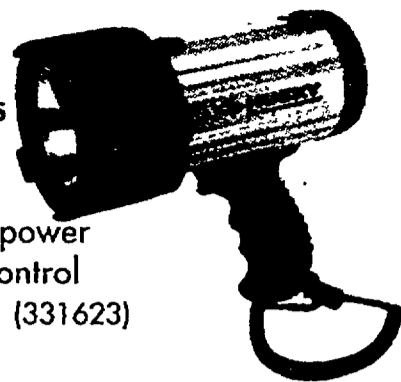

### Husky® Rechargeable Worklight

Rechargeable power base provides a 12-volt outlet.

**\$26<sup>97</sup>**

HSK142R (148532)

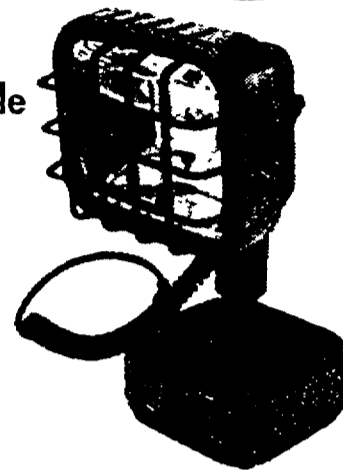

### Husky® Digital Electronic Flashlight

Rechargeable 3-LED area light.

**\$29<sup>97</sup>**

HSK155S (208042)

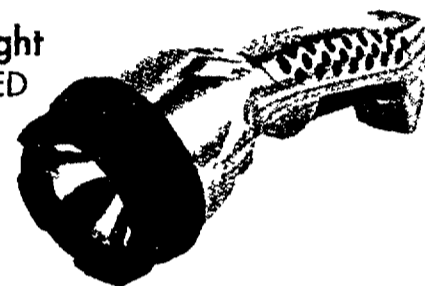

### Mag-Lite® Combo Pack with Holster

Anodized to prevent corrosion. Lifetime warranty.

**\$19<sup>97</sup>**

JX0101H (291391)

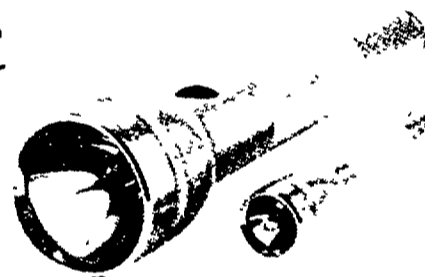

### AA Mini-Mag-Lite® with Holster

Includes spare bulb and anti-shock ring.

**\$7<sup>68</sup>**

JM2AHNR (122963)

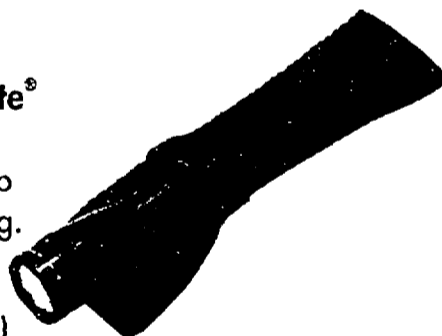

Use with white beam, red beam or emergency flasher

### Husky® 2-Way LED Flashlight

Super-bright, 5-LED main beam.

**\$9<sup>97</sup>**

HSK114S (148482)



Product availability may vary by store location.

**You can do it. We can help.**



Choose your favorite team†

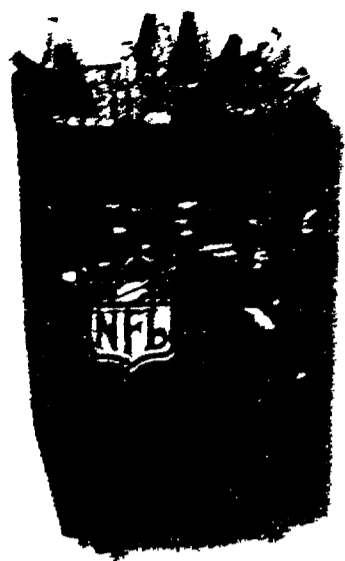

Only at  
The Home Depot  
"Rookie" Compact  
Beverage Center  
The perfect mini-fridge for  
a sports fan. 2.8 cu. ft.  
with removable rack for 30  
bottles or cans. Removable  
snack/ ice tray.  
† Panels sold separately.  
(266544)  
**\$199**



Choose  
your  
favorite  
team†



Skybox™ by Maytag™  
Personal Beverage Vendor  
Holds any combination of 64  
12-oz. cans or 32 12-oz. bottles.  
Available in black or platinum.  
† Stand and team panels are sold  
separately.  
MBV1976AAB/P (171860, 181602)  
**\$499**  
That's only \$16 per month.\*  
Skybox Stand† **\$6999**  
(181565, 181628)

Sports logo panels available for purchase online at: [homedepot.skyboxbymaytag.com](http://homedepot.skyboxbymaytag.com)

# GIFTS THEY'LL USE

Great ideas for every list



Special Buy  
Dirt Devil  
Platinum Force  
Combo Pack  
4 cleaners all  
in one pack:  
Bagless upright  
vacuum,  
rechargeable  
stick vac, hand  
vac and steamer.  
5-year warranty.  
(183317)

**\$129**



Special Buy  
3.6 Cu. Ft.  
Stainless-Style  
Mini-Refrigerator  
Black cabinet. Can  
storage rack included.  
MCBR360S  
**\$9999** (827342)

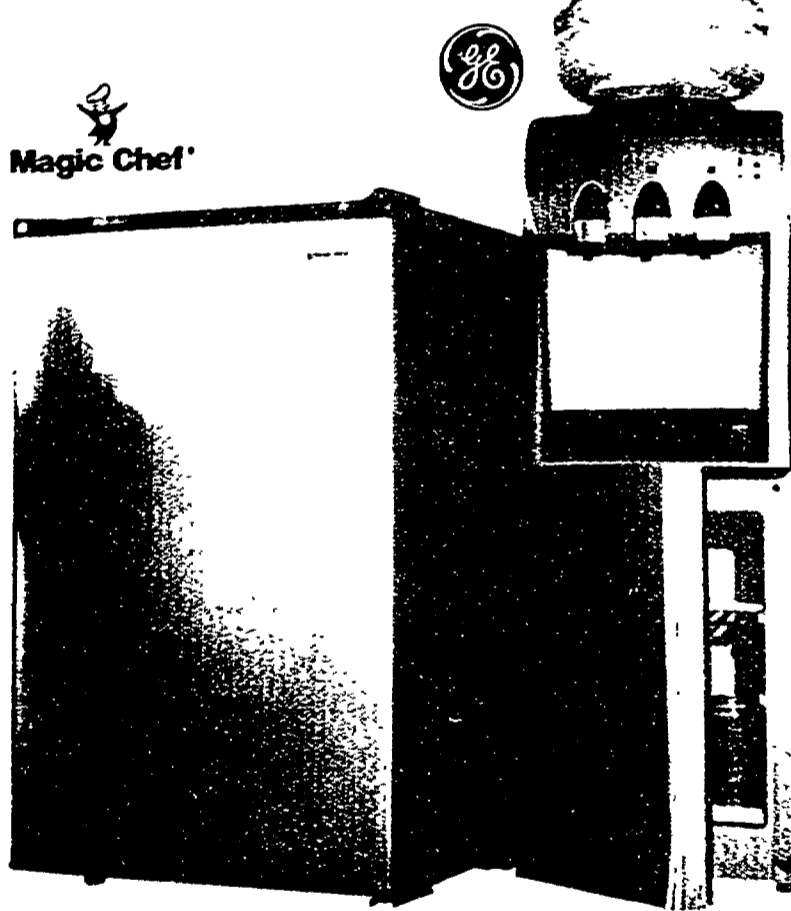

Tri-Temperature  
Water Dispenser with  
Refreshment Chiller  
Cold or hot water. Child-  
resistant hot water faucet.  
Water bottle sold  
separately. GXCF25FBS  
**\$165** (288219)

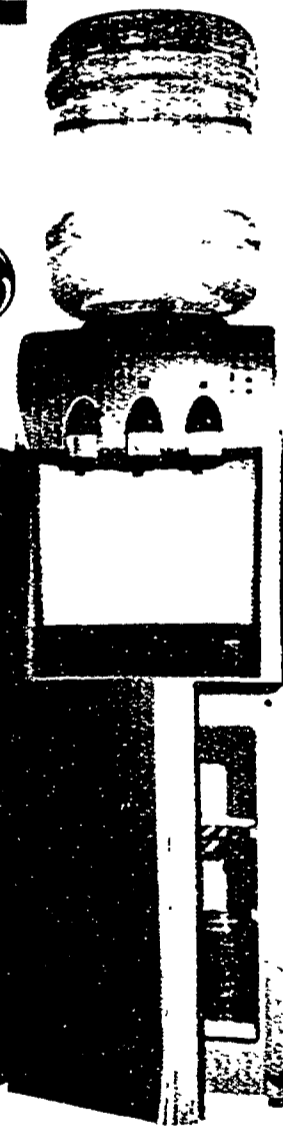

Special Buy  
Only at The Home Depot  
52-Bottle Wine  
Cooler with Bonus  
Wine Opener  
Adjustable temperature  
control. MCWC52B  
**\$149** (600068)

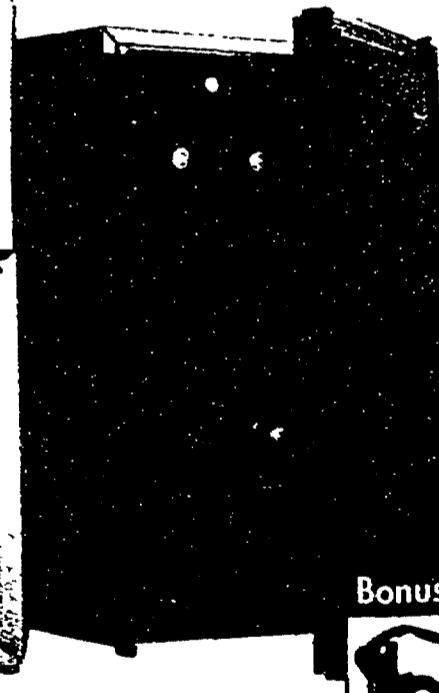

Bonus



www.homedepot.com 1-800-430-3323 325 342 366 369 371 382 383 391-122-4

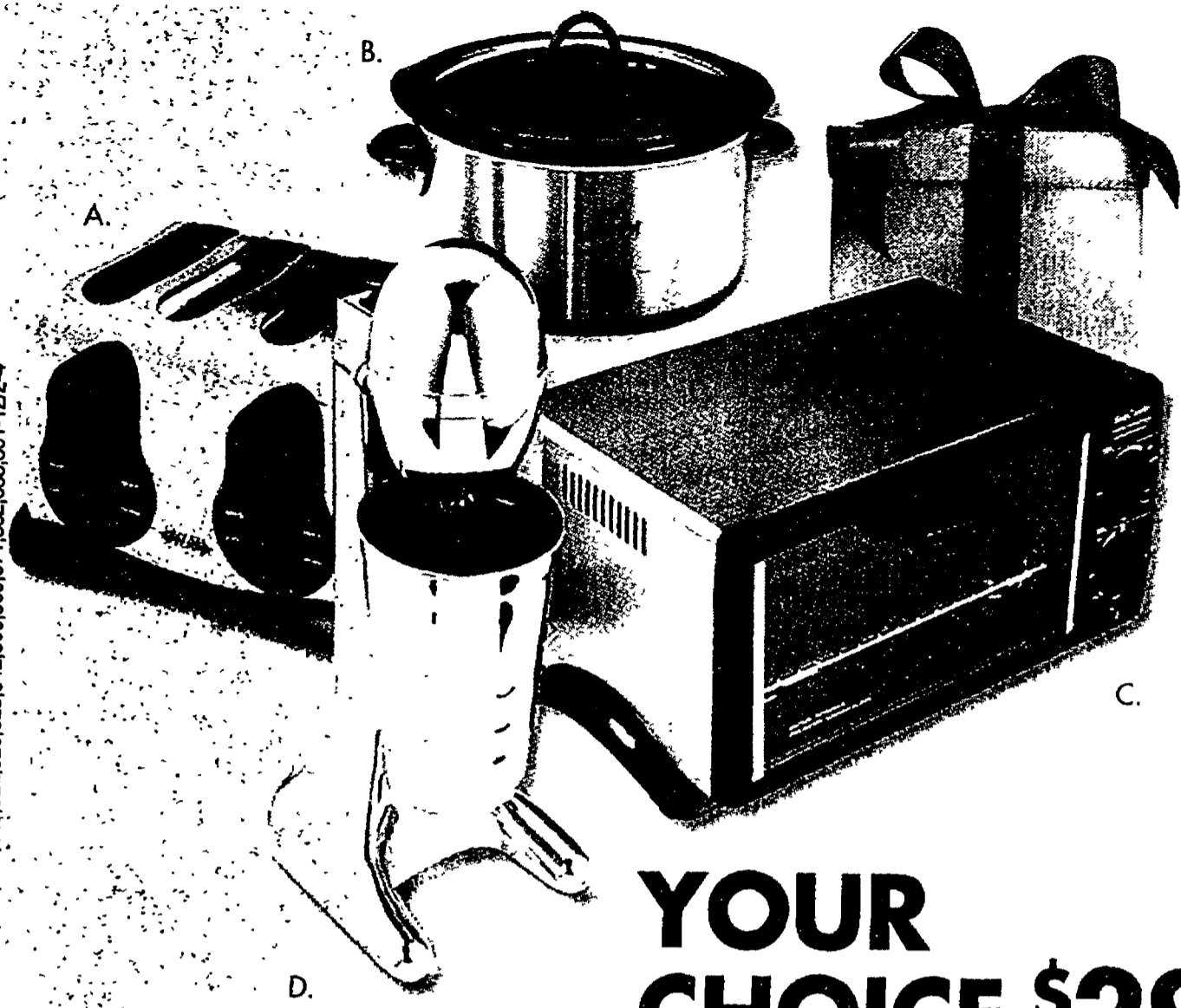

- A. **Aroma Stainless Steel 4-Slice Toaster**  
Extra wide toasting wells. Variable toast browning control.  
PTS204 (198395)
- B. **Rival 5 QT. Round Crock Pot® Slow Cooker**  
Round, removable stoneware with Rinse-Clean™ coating. Bonus "Little Dipper" Slow Cooker  
33511LD-C (262368)
- C. **Betty-Crocker 4-Slice Toaster Oven**  
Stainless steel with continuous-clean interior.  
BCF1620 (354247)
- D. **Hamilton Beach DrinkMaster® Chrome Classic**  
Enjoy thick shakes and soda fountain drinks at home.  
HB730C (344153)

# YOUR CHOICE \$29<sup>99</sup>

**Innovative vacuum does the work while you relax**

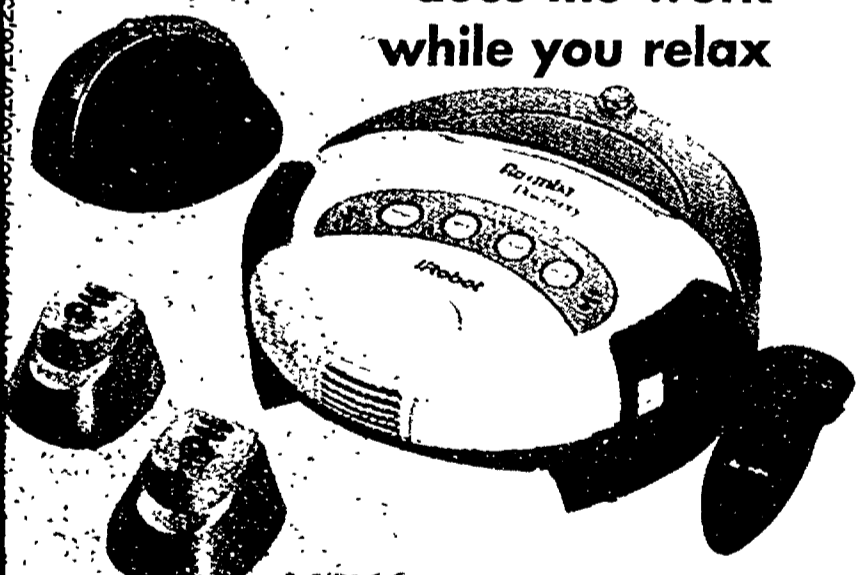

**NEW**  
**Roomba Discovery Robotic Vacuum**  
All the great features of the Roomba Red sold elsewhere but better. 3-hour charger. 2 virtual wall units. MAX cleaning mode for really dirty areas. (593465)

**\$249**



A.

**Electronic Controls with Programmable Timer**

Permanent IFD Filter with Ionizer. Never needs replacement. saves up to \$460 per year†.

A. **Portable Tower Air Purifier with Germicidal protection\***  
Ideal for a 225 sq. ft. room.  
**\$199** ea. (261818)

B. **Portable Tower Air Purifier†**  
Ideal for a 150 sq. ft. room.  
**\$149** ea. (389764)



B.

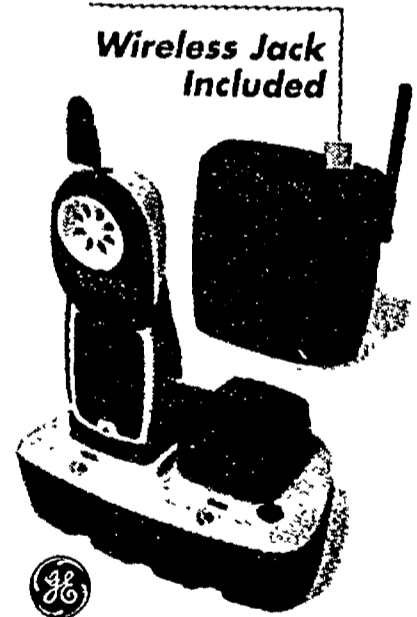

**Wireless Jack Included**



**900 MHz Heavy-Duty Shop Phone**  
Automatically selects the clearest channel. Includes an extra battery. Call waiting/Caller ID. (590824)  
**\$79<sup>99</sup>**

**You can do it. We can help.**



Product availability may vary by store location.

†Based on 10 years of usage.



# THE LOWEST PRICES

## Only at The Home Depot Super Capacity Top-Loading Washer

Commercial quality. 11 cycles and extra rinse option. FlexCare™ agitator. 4 water levels. SAV205DAWW (421094, Depot Direct 544372)

**\$399**

Only \$17 per month\*

## Super Capacity Dryer<sup>††</sup>

This commercial-quality dryer has a soft side too. The GentleBreeze™ drying system expertly cares for your delicates.

SDE305DAYW (421103, Depot Direct 546038)

**\$379**

Only \$17 per month\*

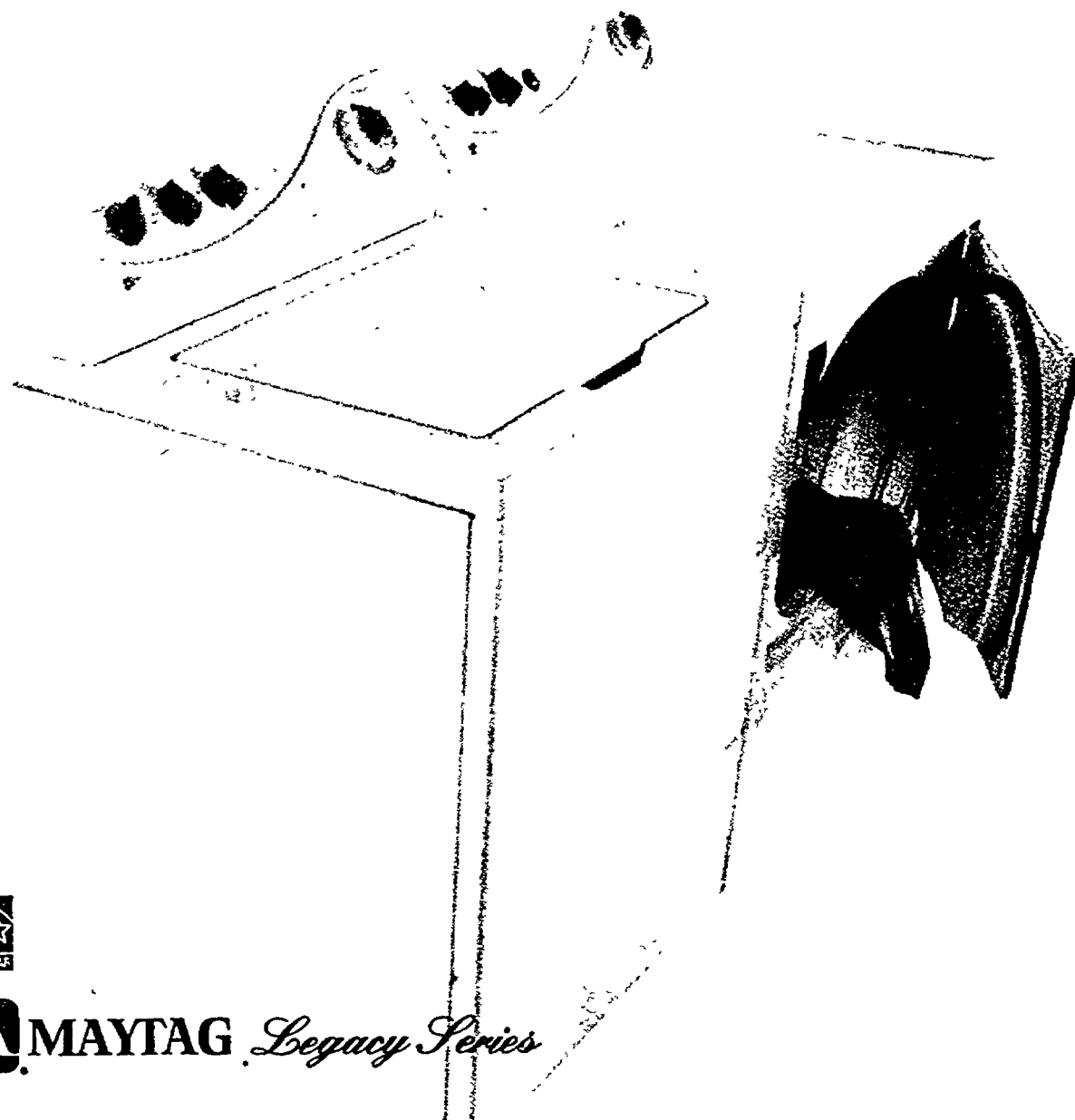

**MAYTAG** Legacy Series

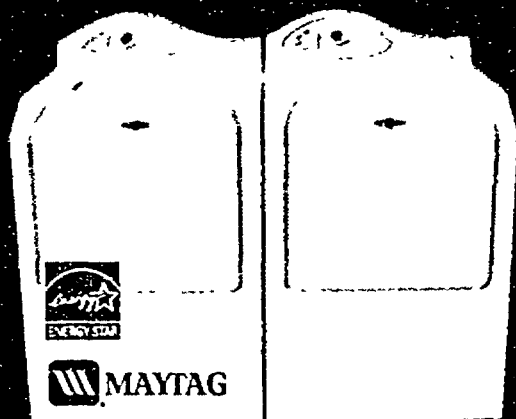

**Neptune® Washer**  
Saves up to \$100 per year in water and energy\*\*  
MAH55FIBWW (Depot Direct 185546)

**\$799** Only \$23 per month\*

**Neptune® Dryer<sup>††</sup>**  
Easy-to-use touchpad controls  
MADE5500AYW (Depot Direct 204396)

**\$699** Only \$22 per month\*

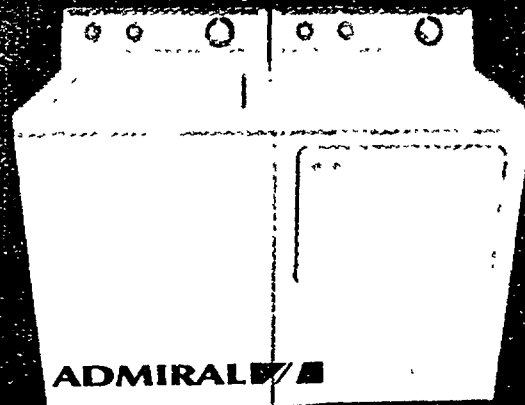

**Only at The Home Depot  
Super Capacity Washer**  
3.3 cu. ft. super capacity washer  
AAV7000AWW (583967, Depot Direct 573207)

**\$319** Only \$13 per month\*

**Super Capacity Dryer<sup>††</sup>**  
7.1 cu. ft. capacity  
(583075, Depot Direct 573210)

**\$299** Only \$13 per month\*

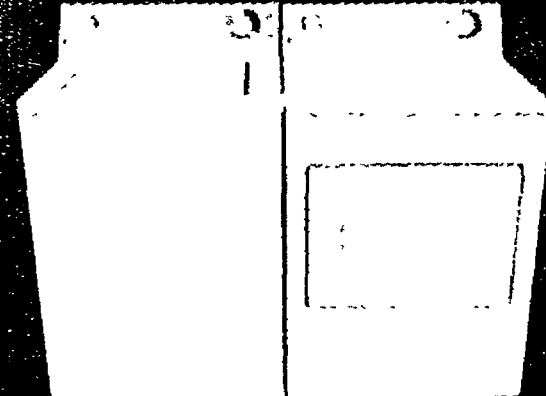

**Only at The Home Depot  
Super Capacity Washer**  
Electro-mechanical controls.  
(155570, Depot Direct 326177)

**\$259** Only \$13 per month\*

**Super Capacity Dryer<sup>††</sup>**  
Auto Dry. Uses thermostats to monitor air temperature.  
(575292, Depot Direct 561936)

**\$239** Only \$10 per month\*

# GUARANTEED



**Stainless Steel Dishwasher**  
Tall tub. Stainless steel interior. 5-level/7-tier wash system.  
MDB8750AWS  
(Depot Direct 478734)  
**\$769** Priced lower in store.  
Only \$23 per month\*



**JetClean® 3-Level Dishwasher+**  
7-tier JetClean® II wash system. QuietSeries 200 sound package.  
MDBH970AWW/B  
(280813, 280495, Depot Direct 361354)  
**\$499**  
Only \$16 per month\*



Only at The Home Depot  
**Built-In Dishwasher XtraClean™** wash system. "America's Most Dependable Washers!"\*\*\*  
GHDA960KWW/BB  
(550762, 550775, Depot Direct 554659, 554096)  
**\$349**  
Only \$13 per month\*



**Built-In Dishwasher**  
Standard wash system with 2 washlevels.  
(114206, 114174, 519480, Depot Direct 109917, 108937, 480021)  
**\$239**  
Only \$10 per month\*

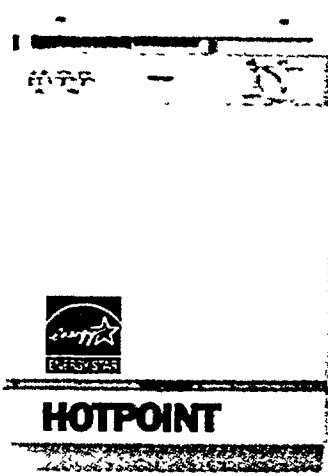

**Built-In Dishwasher**  
Trimless door design. Deluxe lower rack accommodates large plates and broiler pans.  
HDA3400GWW/BB/CC  
(Depot Direct 172774, 446097, 172888)  
**\$199**

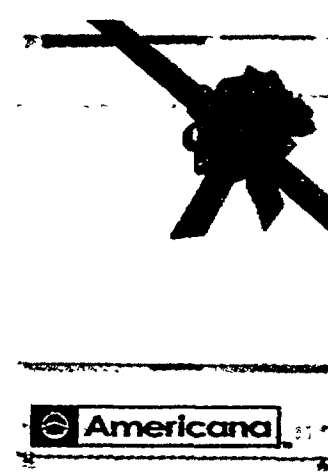

Only at The Home Depot  
**Built-In Dishwasher Trimless Door** for a seamless look. Deluxe lower rack with curved tines for larger items.  
AWD1000KWW  
(387282, Depot Direct 381286)  
**\$169**

## NEW!

**Stackable Front-Load Washer**  
TurboClean™ wash system cleans without an agitator. 2.41 cu. ft. capacity is largest in its class.  
MAH2400AWW  
(389674, Depot Direct 390029)

**\$699** Priced lower in store.  
Only \$22 per month\*

**Stackable Large Capacity Dryer††**  
Fits in tight spaces, under counters or stacked. Largest capacity in its class.  
MDE2400AYW  
(389725, Depot Direct 390059)

**\$499** Priced lower in store.  
Only \$16 per month\*

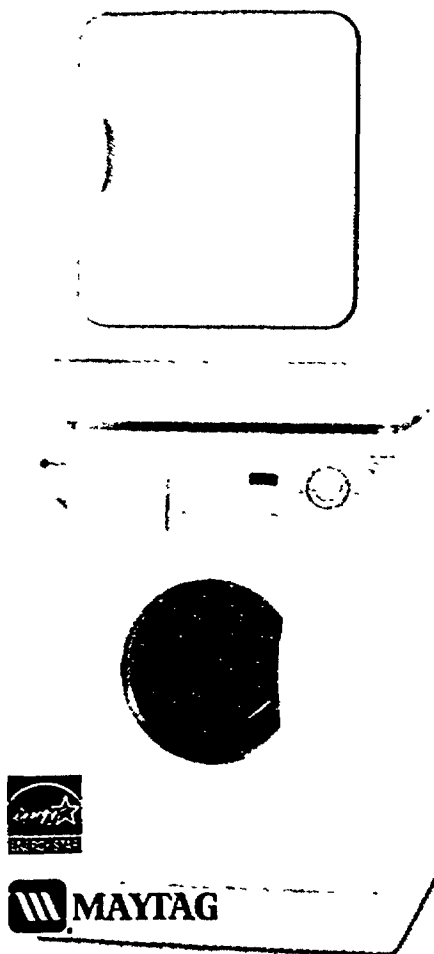

Only at The Home Depot  
**Jetclean® II Dishwasher+**  
Tall tub has the largest usable capacity.\*\*\*  
(581739, 581750, Depot Direct 581701, 581717)  
MDBH940AWW/B  
**\$349**  
Only \$13 per month\*  
\*\*\*As measured by usable rack volume, based on standard size dishwashers.

Product availability may vary by store location.

**You can do it. We can help.**



\*Stainless steel available at additional cost. \*\*Based on an independent national survey of consumers who have purchased a leading brand of washer from 2001-2004.

ap1 - 75,72,101,64,67,106,115,120,127,131,139,143,156,157,158,164,169,185,206,207,208,235,237,246,247,262,276,298,300,304,310,314,317,320,322,323,325,342,366,369,371,382,383,391-122-4

# OVER 2,000 APPLIANCES

Plus free delivery makes it easy\*\*

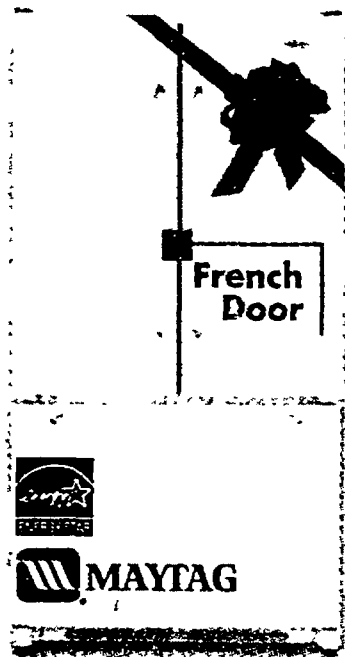

**24.8 Cu. Ft. French Door Refrigerator**  
PuriClean™ filter and dispenser. Spill-Catcher™ shelves. MFD2560HEW  
(Depot Direct 531953)

**\$1699**

Only \$43 per month.\*

Stainless steel available at additional cost. Select Maytag models priced lower in store.

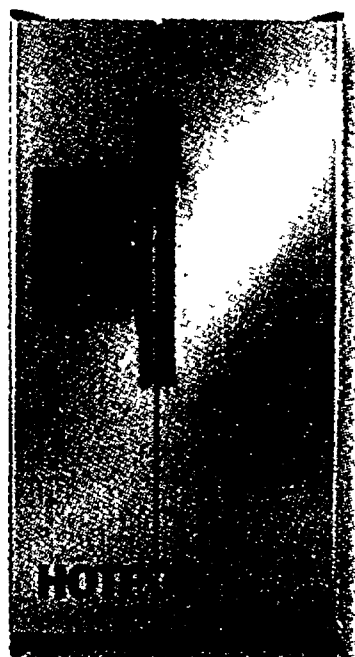

**Only at The Home Depot**  
**24.9 Cu. Ft. Silver Metallic Side-by-Side Refrigerator**

The look of stainless at an affordable price. Filtration system HSM25GFRSA (513653, Depot Direct 510675)

**\$899**

Only \$25 per month.\*

**MAYTAG**

**25.6 Cu. Ft. Side-by-Side Refrigerator**

Electronic cubed/crushed ice. PuriClean II retractable water and ice filter. QuietSeries 100 sound silencing system. Available in white, black, or bisque.

MSD2651HEW  
(Depot Direct 571725)

**\$999**

Only \$28 per month\*

Stainless steel available at additional cost. Select Maytag models priced lower in store.

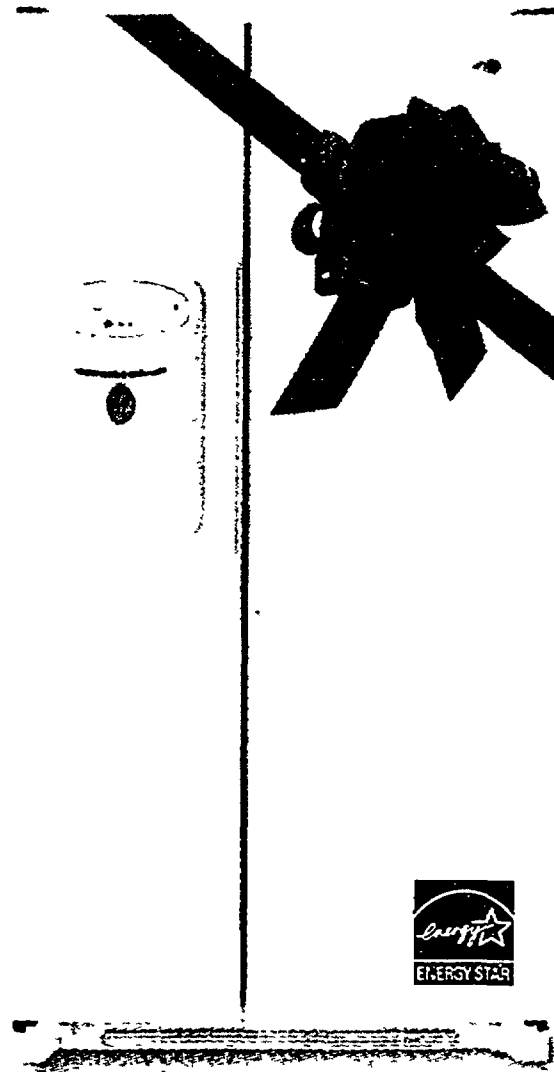

**MAYTAG**  
**25.6 Cu. Ft. Side-by-Side Refrigerator**  
Spill-Catcher shelves including glass crisper shelf. Sealed FreshLock crisper with humidity control. MSD2651HES  
(Depot Direct 571757)  
**\$1329**  
Only \$87 per month.\*  
Priced lower in store.

**GE**  
**22.2 Cu. Ft. Bottom Freezer Refrigerator**  
Full width sliding freezer basket. Factory installed icemaker. Gallon door storage. GBS22HCRWW.  
(Depot Direct 138625)  
**\$849**  
Only \$23 per month.\*  
Priced lower in store.

**GE**  
**17.9 Cu. Ft. Refrigerator**  
Upfront temperature controls. Adjustable glass shelves. Vegetable/fruit crispers. GTS18GBRWW.  
(513247, Depot Direct 504793)  
**\$399**  
Only \$17 per month.\*

\*\*Free Delivery And haul away on ANY appliance purchases of \$399 or more. A \$50 value. Offer valid through 2/21/05 by mail-in rebate with any appliance purchase totaling \$399 or more delivered through Depot Direct. Normal Depot Direct delivery terms apply. Delivery not available in some areas. Offer valid in U.S. and Puerto Rico. Not valid with any other offer. Offer only available at The Home Depot. See rebate form for redemption details. Maximum rebate value \$50.



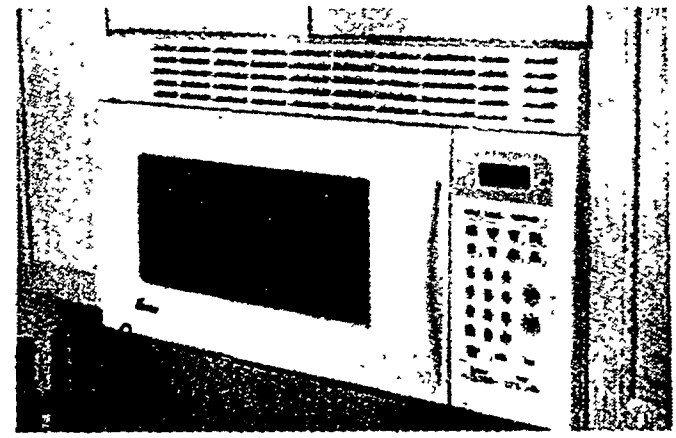
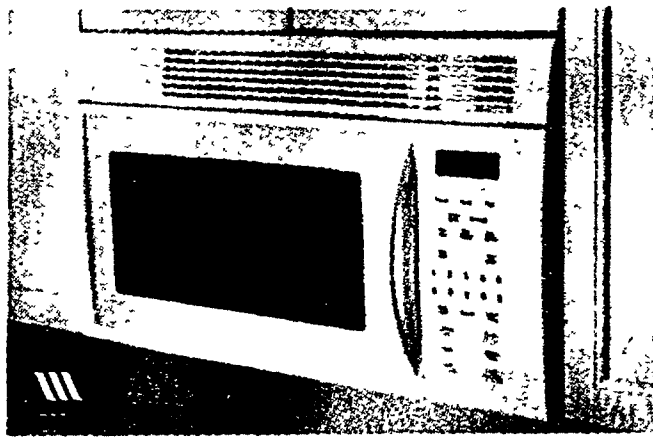
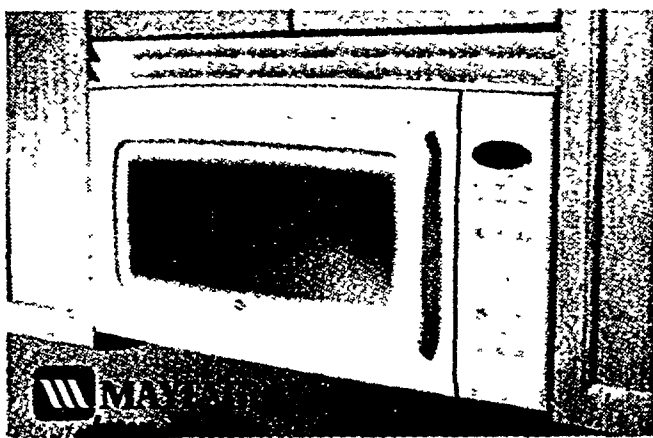

**2.0 Cu. Ft. Over-the-Range Microwave**  
1150 Watts. Auto-Cook options.  
Available in white, black or bisque.  
MMV4205AAW/B/Q (575351, 575348,  
Depot Direct 574987, 574929, 574996)

**\$299** Only \$13 per month.\*

Stainless steel available at additional cost.

**1.5 Cu. Ft. Over-the-Range Microwave**  
1000 Watts. Auto-Cook option.  
Available in white, black or bisque.  
MMV1153AAW/B (575326, 575285,  
Depot Direct 574901, 574691)

**\$199**

**Only at The Home Depot**  
**1.5 Cu. Ft. Over-the-Range Microwave**  
1000 Watts. 6 pre-programmed one-touch  
cooking pads. White, black, or bisque.  
MC0153UW/B (436240, 430618)

**\$149**

Stainless steel available at additional cost.

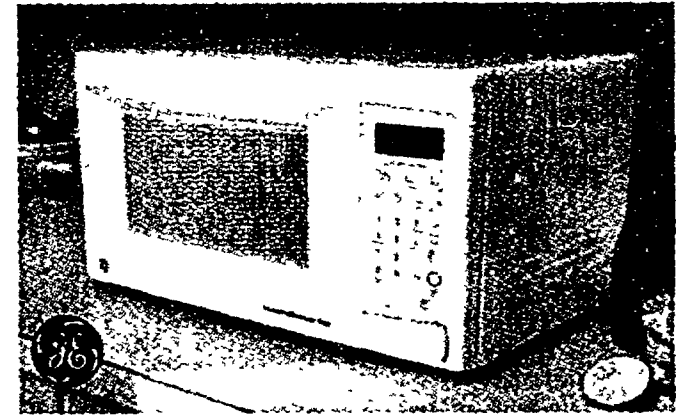
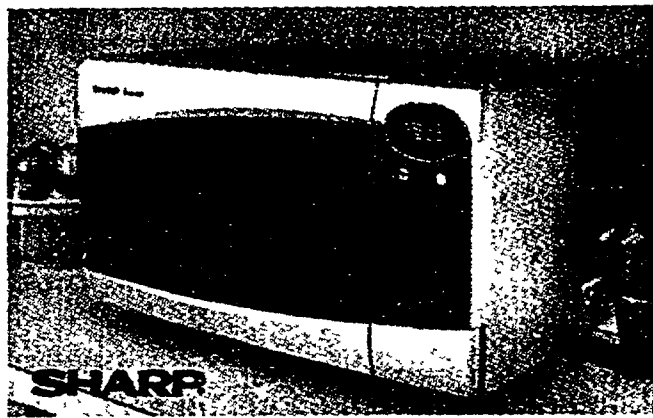
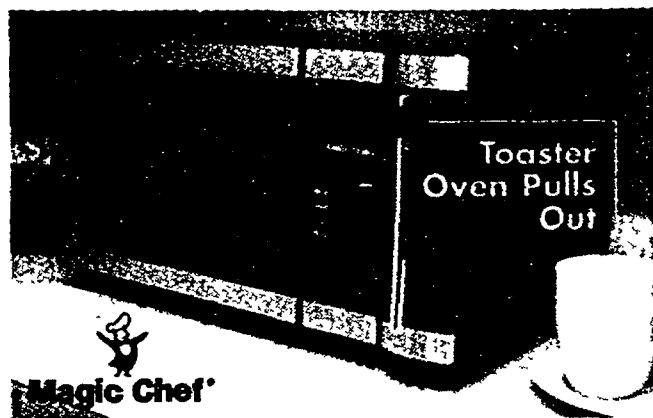

**Special Buy**  
**Only at The Home Depot**  
**.9 Cu. Ft. 1000 Watt Microwave**  
with Built-In Toaster  
10 power levels. Child safety lock on toaster.  
MCT9E1ST (382107)

**\$7999**

**1.0 Cu. Ft. 1100 Watt Silver Microwave Oven**  
11 variable power levels. Programmable  
for 3 cooking stages.  
R308JS (122227)

**\$6999**

**.8 Cu. Ft. 800-Watt Microwave**  
10-power levels. 3 menu 1-touch  
pre-programmed cooking options.  
JES831WF (276039)

**\$4999**

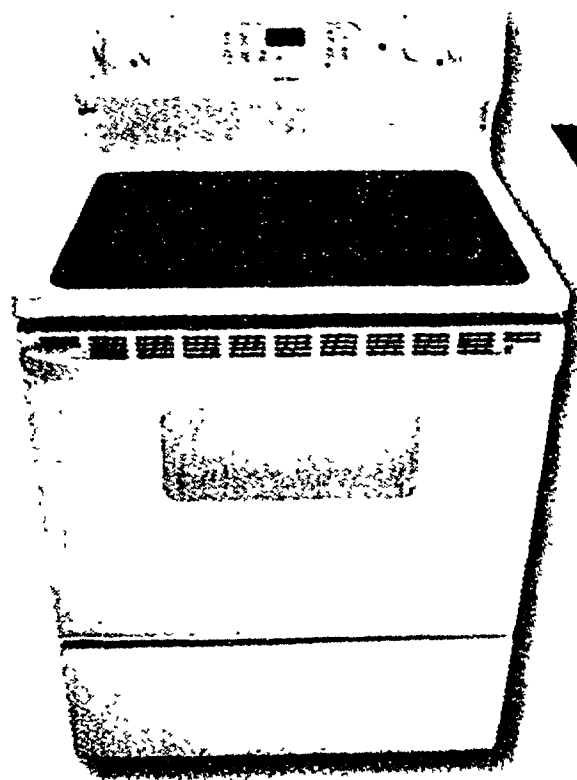

**HOTPOINT**  
**YOUR CHOICE**  
**\$399** Only \$17 per month.\*

**30" Self-Cleaning Electric Range**  
Radiant glass cooktop. Super-large oven  
capacity. Monochromatic styling.  
RGB740BEHWH (440055, Depot Direct 343825)

**30" Self-Cleaning Gas Range**  
Sealed burners. Extra-large oven  
capacity. Maximum output burner.  
RB787WHWW (130949, Depot Direct 523449)

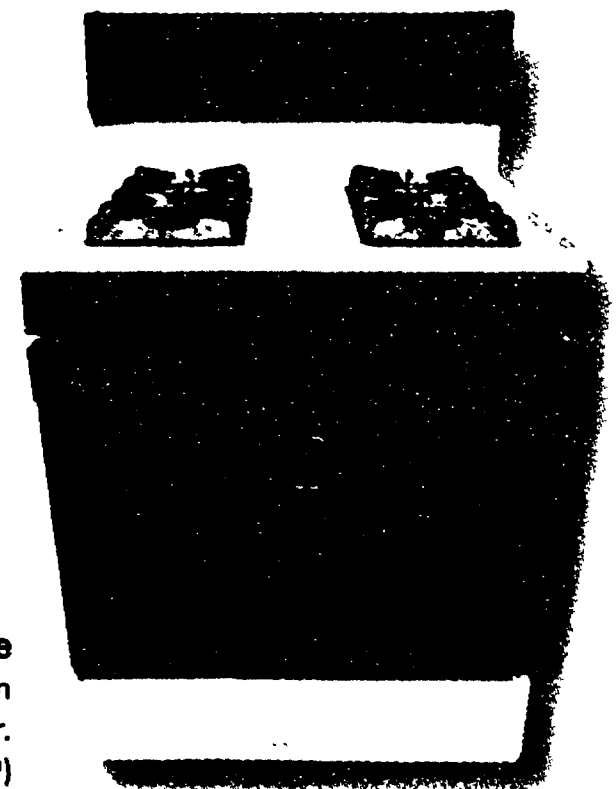

**You can do it. We can help.**



Product availability may vary by store location.

ap1 - 75,72,101,64,67,106,115,120,127,131,139,143,156,157,158,164,169,185,206,207,208,235,237,246,247,262,276,298,300,304,310,314,317,320,322,323,325,342,366,369,371,382,383,391-1212-4

# HAMPTON BAY<sup>®</sup>, AMERICA'S #1

Innovative collections at affordable styles

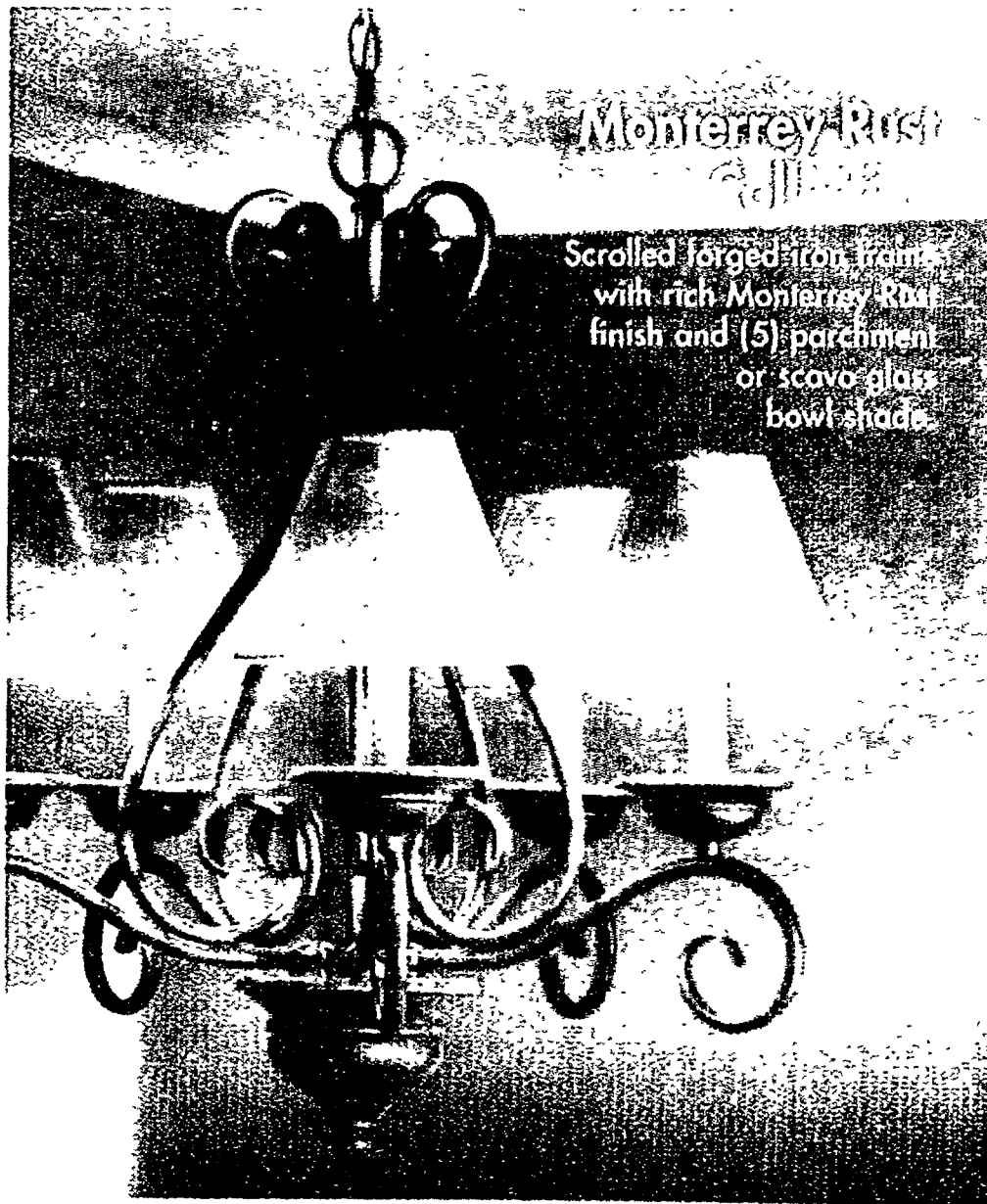
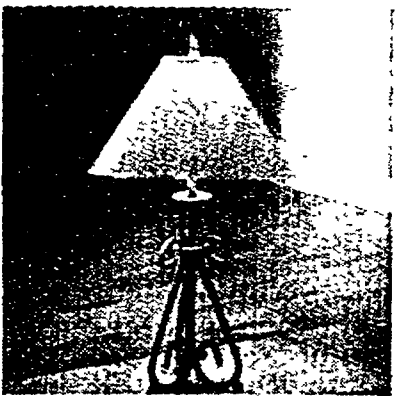
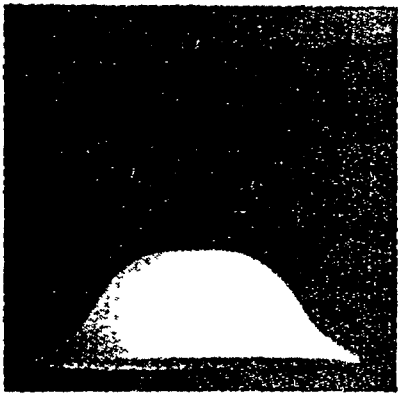

Monterrey Rust  
Scrolled forged iron frame with rich Monterrey Rust finish and (5) parchment or scavo glass bowl shade.

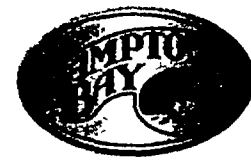

## 5-Light Chandelier

25-1/2"W x 25-1/2"H. (320072)

**\$187**

## Downlight Pendant

16"W x 16-1/2"H. (468781)

**\$68<sup>96</sup>**

## Wall Sconce

7"W x 12-1/2"H. (320067)

**\$29<sup>80</sup>**

2-Light Sconce (469790) **\$49<sup>87</sup>**

## Table Lamp

30-1/4"H. (393435)

**\$59<sup>97</sup>**

Floor Lamp (542091) **\$69<sup>78</sup>**

## Del Rio Collection

Aged crackle finish with etched marble glass shade.

### 5-Light Chandelier

27"W x 25"H.

(317977)

**\$149**

### Downlight Pendant

15-3/4"W x 13-3/4"H.

(453472)

**\$98<sup>85</sup>**

### Foyer Pendant

13"W x 20"H.

(338256)

**\$79<sup>87</sup>**

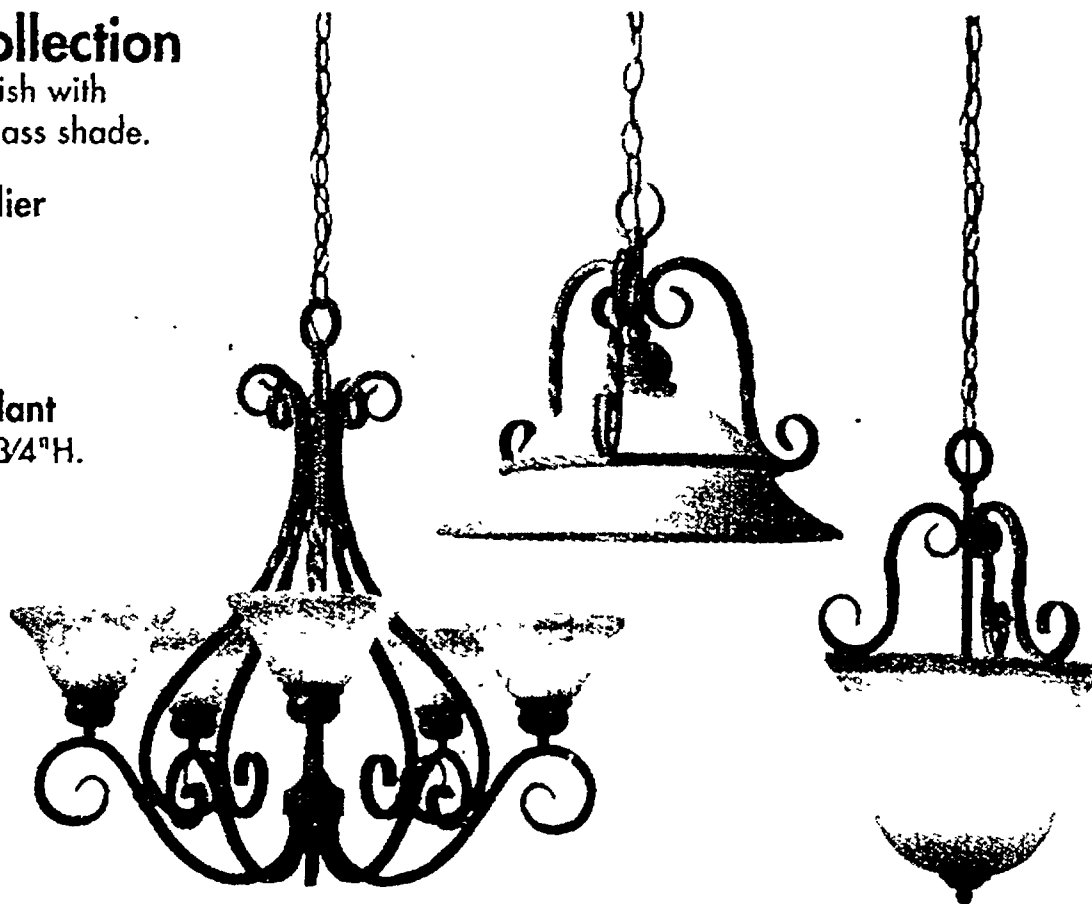

## Find Exactly What You Want

### Special Order

Select from the latest designs and finishes to complement any décor with our exclusive Hampton Bay<sup>®</sup> Gallery Collection. Ask an Associate to see our exciting selection.

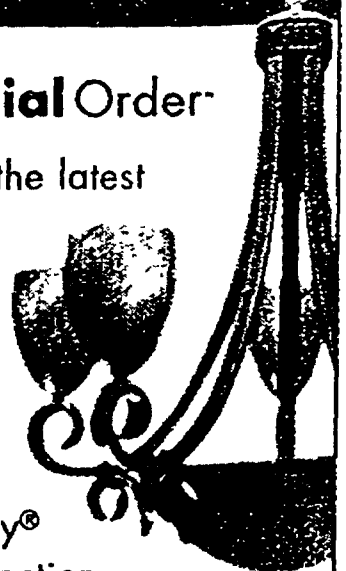

# CHOICE IN LIGHTING BRANDS

to update every room in your home

## Chrome & Nickel Finishes

The clean sheen of these finishes brightens and modernizes your decor. Choose from many updated styles.

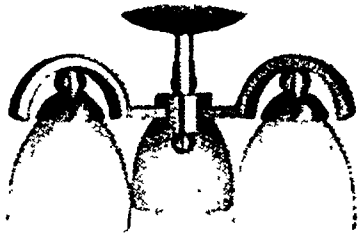

**Brushed Nickel Semi-Flush**  
9-1/8"H x 15-1/2"D  
**\$6972** (543174)

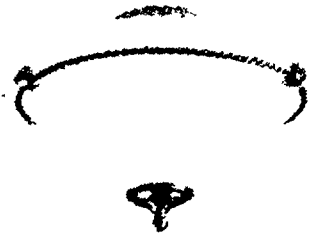

**Brushed Nickel Semi-Flush**  
13"W x 8-3/8"H  
**\$4986** (739823)



**Polished Chrome Flushmount**  
11-1/2"W x 3-3/4"H  
**\$2486** (400292)



**Satin Nickel Flushmount**  
8-1/2"W x 9-3/8"H  
(554297)  
**\$1983**

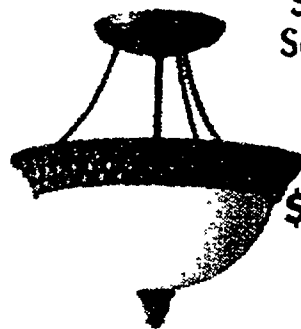

**Savannah Semi-Flush**  
13"W x 13-1/4"H  
(400287)  
**\$5986**



**Nutmeg Flushmount**  
13-1/4"W x 7-1/4"H  
**\$3789** (329011)

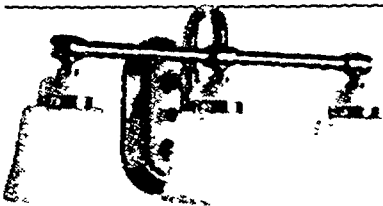

**Chrome & Porcelien 3-Light Bath Bar**  
21-1/4"W x 9-5/8"H  
**\$8962** (394542)



**Brushed Nickel 3-Light Bath Bar**  
22"W x 7-1/4"H  
**\$7998** (375195)  
Sconce (375179) **\$3982**

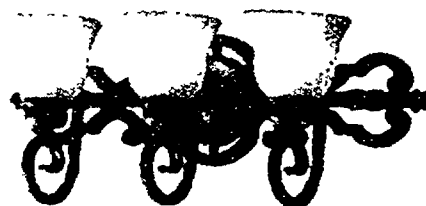

**Del Rio Aged Crackle 3-Light Bath Bar**  
27-1/2"W x 9-3/4"H  
**\$9997** (288984)

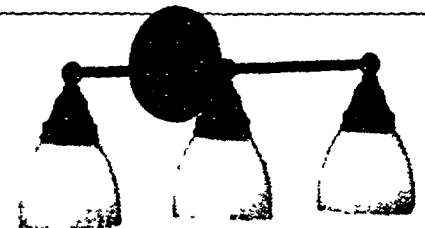

**Bronze 3-Light Bath Bar**  
22-3/4"W x 9-3/4"H  
**\$6987** (159052)  
Wall Sconce (159441) **\$2986**

2-Light (394537) **\$6992**  
Sconce (394514) **\$4998**

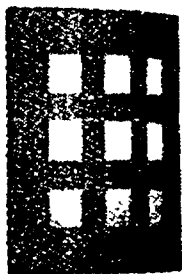

**Sonio Satin Nickel Wall Sconce**  
10"W x 10-3/4"H  
(361080)  
**\$5998**



**Polished Chrome Wall Sconce**  
5-1/8"W x 7"H  
(436327)  
**\$4468**  
3-Light (436879) **\$8897**  
2-Light (436788) **\$6589**

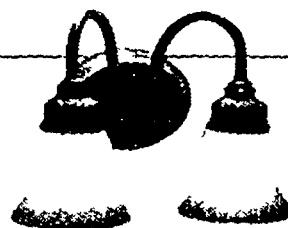

**Tuscan 2-Light Bath Bar**  
13-3/4"W x 9-5/8"H (828064)  
**\$6896**  
3-Light (828065) **\$9786**  
Wall Sconce (828048) **\$4786**



**Chesterfield Aged Bronze Wall Sconce**  
6-1/2"W x 8-1/2"H x ext 8-3/4"H (827866)  
3-Light (828045) **\$129** **\$4896**

Product availability may vary by store location.

You can do it. We can help.



ap1 - 75,72,101,64,67,115,120,127,131,139,143,156,157,158,164,169,185,206,207,208,235,237,246,247,262,276,298,300,304,310,314,317,382,383,12/24



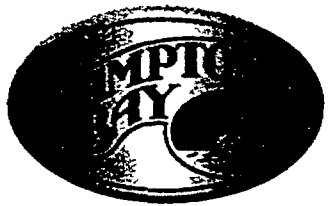

**New Pewter Torchiere with Reading Light**

Torchiere has metal shade; reading light has marbled glass shade. Includes bulbs. 70-3/4"H. (828067)

**\$7982**

**New Pewter Torchiere with Shade**

Pewter finish with metal and glass shade. Includes bulbs. 71-1/4"H. (828069)

**\$6973**

**Incandescent Torchiere**

A cobalt-blue glass accent with brushed steel shade. 70-3/4"H. (232856)

**\$3988**

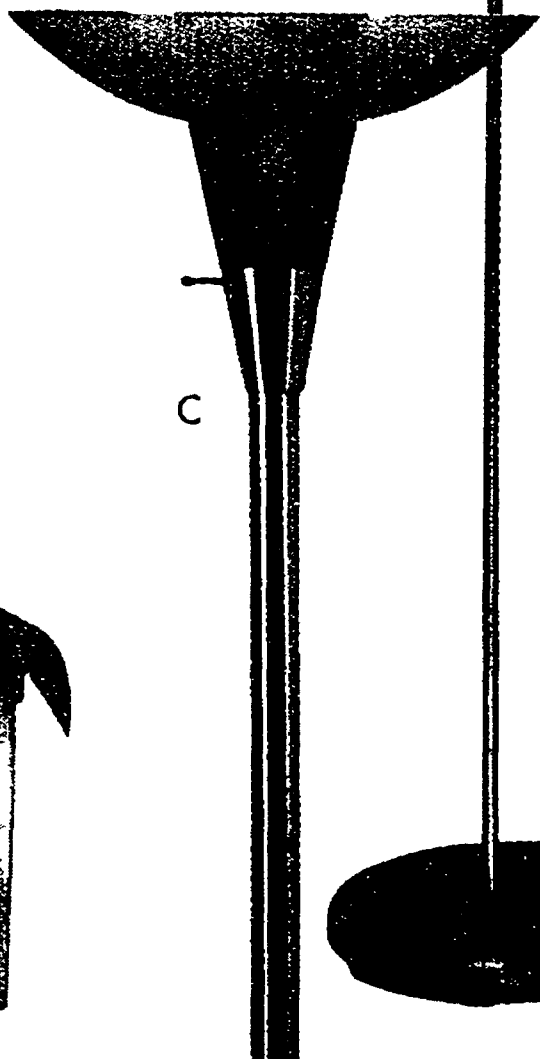
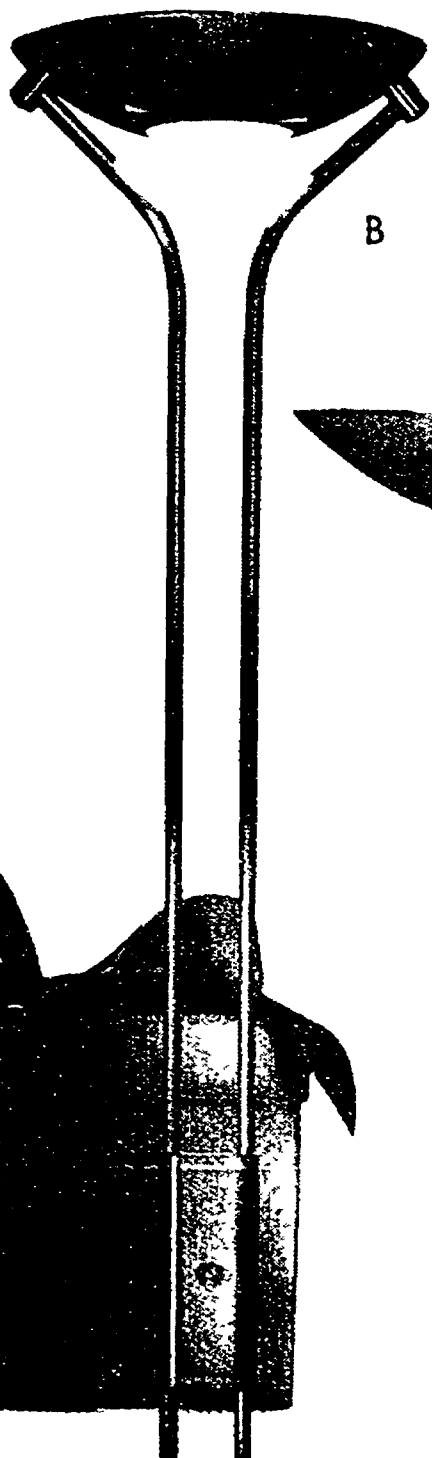
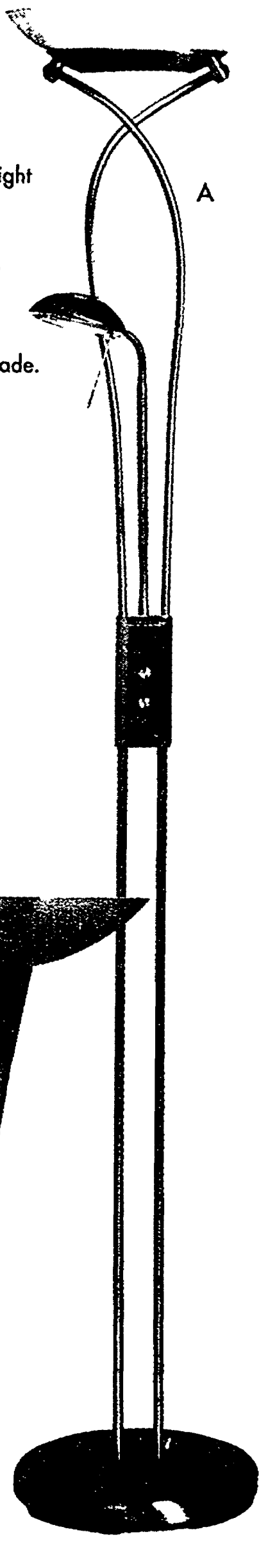

**STYLISH LIGHT,**  
Easy updates or gifts just in time



**New 6-Light Cable Track Kit**  
Brushed steel finish with 6 mesh shades. Cable spans up to 25' with 150-watt low-voltage transformer and mounting hardware. Includes bulbs. (186409)

**\$99**

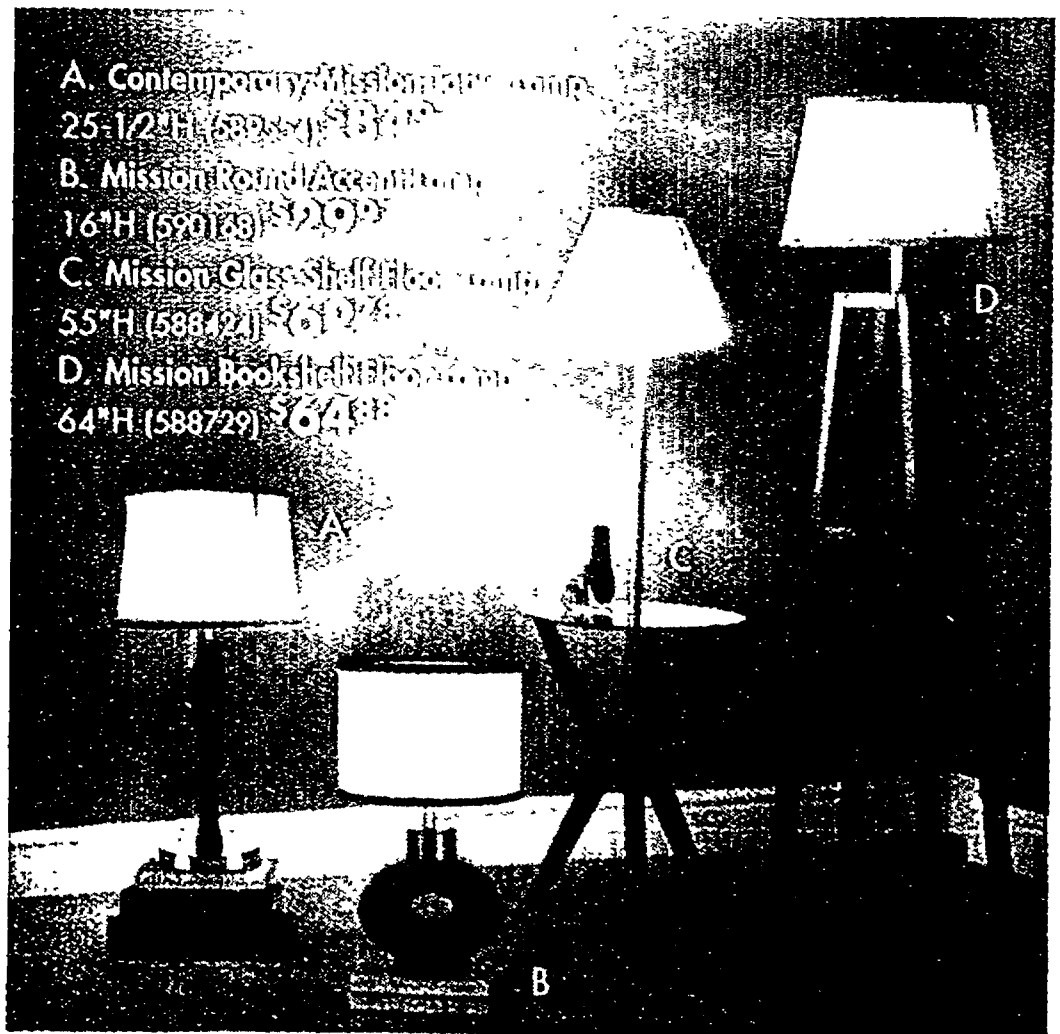

- A. Contemporary Mission Table Lamp, 25-1/2"H. (589841) \$129
- B. Mission Round Accent Lamp, 16"H. (590188) \$129
- C. Mission Glass Shelf Table Lamp, 55"H. (588421) \$129
- D. Mission Bookshelf Table Lamp, 64"H. (588729) \$129

# PRICED RIGHT

for the holidays

## Komet 5-Light Flexible Track Kit

Create custom shapes with easy-to-bend, platinum metallic finished track. Includes 5 frosted and 5 blue glass shades, plus MR16 halogen bulbs for bright-white directional lighting.

(447909)

Includes  
Interchangeable  
Shades

**\$169**

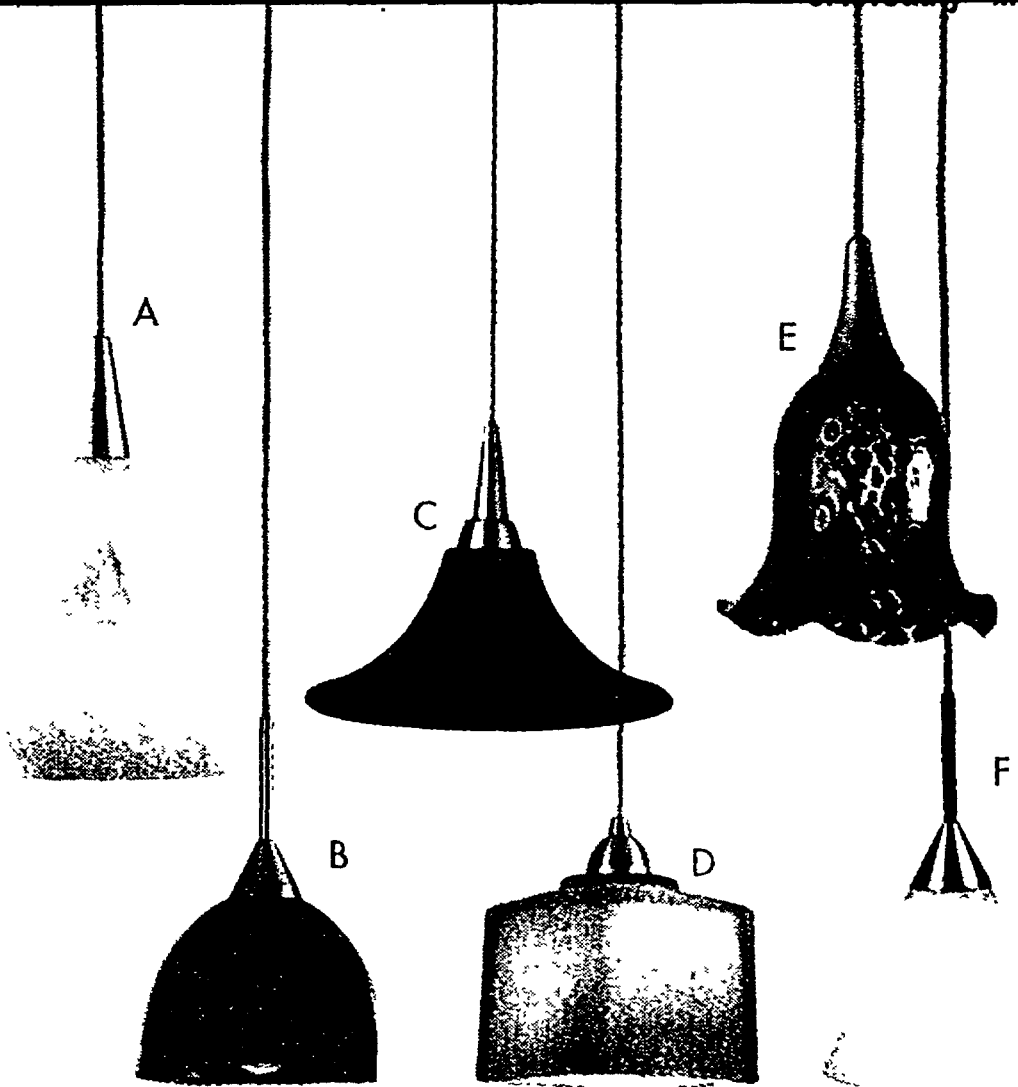
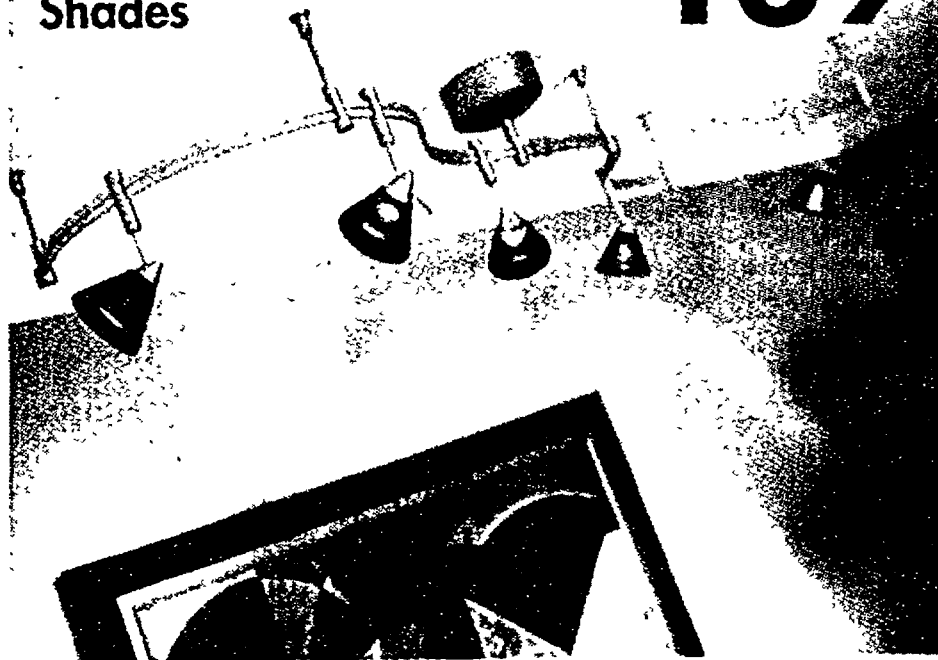

## Adjustable Glass Mini Track Pendants

A. Amber Cone  
3-1/2"W (343533) **\$34<sup>97</sup>**

B. Red Dome  
4"W (531696) **\$29<sup>97</sup>**

C. Italian Cone  
6-3/4"W (343552) **\$34<sup>97</sup>**

D. Amber Cube  
3-3/4"W (531684) **\$29<sup>97</sup>**

E. Campanella  
5-1/4"W (501900) **\$39<sup>96</sup>**

F. White Cone  
4"W (440724) **\$29<sup>96</sup>**



## Hang Your Pendants from Track Canopies or Sections

Platinum Finish Track  
Pendant Canopies

1-Light (170779) **\$19<sup>97</sup>**

3-Light (170904) **\$29<sup>96</sup>**

White Track Sections

2' (555218) **\$5<sup>97</sup>**

4' (555219) **\$9<sup>97</sup>**

8' (555235) **\$19<sup>97</sup>**

3-Wire Monopoint Connector

(555214) **\$9<sup>97</sup>**

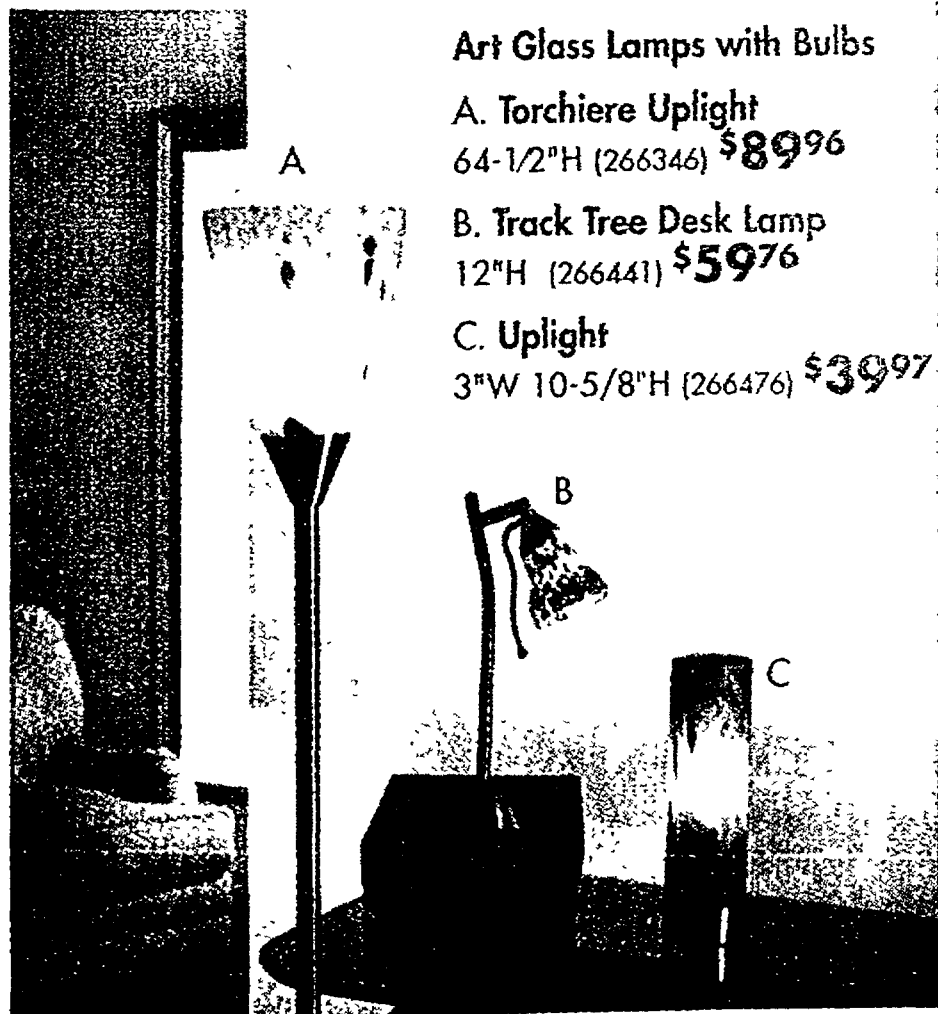

## Art Glass Lamps with Bulbs

A. Torchiere Uplight  
64-1/2"H (266346) **\$89<sup>96</sup>**

B. Track Tree Desk Lamp  
12"H (266441) **\$59<sup>76</sup>**

C. Uplight  
3"W 10-5/8"H (266476) **\$39<sup>97</sup>**

Friday at 7pm  
**FREE** How-to Clinic  
You Can Install  
Track Lighting

By the end of this seminar,  
you'll know: exactly which  
tools you'll need, basic safety  
practices, simple wiring tech-  
niques and how to install a  
mounting plate and track.

Product availability may vary by store location.

**You can do it. We can help.**



ap1 - 75,72,101,64,67,106,115,120,127,131,139,143,156,157,158,164,169,185,206,207,208,235,237,246,247,262,276,298,300,304,310,314,317,320,322,323,325,342,366,369,371,382,383,391-12/2-4



**Special Buy  
Platinum Force  
Combo Pack**  
4 cleaners all in  
one pack: Bagless  
upright vacuum,  
rechargeable stick  
vac, hand vac and  
Steamer. 5-year  
warranty. (183317)

**\$129**



# AMERICA'S LARGEST

Buy now and have it installed before



## Lookin' Good Texture

7-year stain and soil, 10-year wear  
warranties. 32 oz. face weight.  
12' width. In stock.  
(434943)

**\$129**  
sq. ft.

## 72 Hour Carpet Installation

 **Expert  
Installation**

Available on  
Select Carpets

### Your One Reliable Source for Selection and Installation

A flooring Associate will assist you  
in choosing the best carpet and  
colors for you home and lifestyle.  
Our trained experts provide  
estimates, confirm measurements  
and handle all aspects of  
installation so you don't have to.

- Reliable
- Quality Work
- Guaranteed
- Financing

Ask a Flooring Associate for details.  
Home Depot License: See page 30

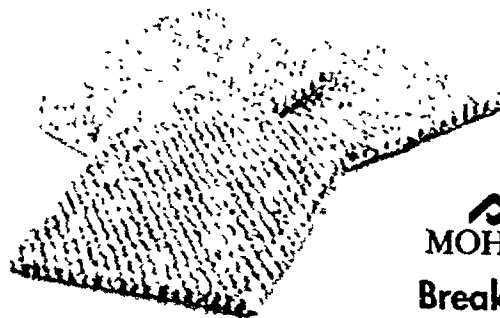

  
**MOHAWK**  
Breakpoint  
Loop Berber

10-year wear, stain and fade warranty.  
10-year anti-static warranty. Available in  
Parchment color. In stock.

**\$108** sq. ft. (577958)



  
**MOHAWK**  
Morocco  
Textured Berber

5-year stain and fade,  
10-year wear warranties. Available in  
Arrowheat color. 12' width. In stock.

**95¢** sq. ft. (416145)



  
**BEAULIEU  
of AMERICA**  
Thoroughbred  
Texture

5-year stain, 10-year  
wear warranties. Available in  
Chestnut color. 12' width. In stock.

**88¢** sq. ft. (595134)



**Sizzle**  
Patterned Loop

10-year quality assurance warranty.  
Available in Grand Slam color. 12' width.  
100% olefin. In stock.

**70¢** sq. ft. (591534)



# FLOOR STORE

the holidays



**\$89**

**New 5'x8' Cream  
Shag Area Rug**

(583386)

2'x8' (583378) **\$44<sup>99</sup>**

2'x3'4" (583372) **\$19<sup>99</sup>**

**\$229**

**New 5'3"x7'10"  
Bamboo Garden  
Area Rug**  
(352583)

2'11"x7'10"  
(352411) **\$98**

2'x3'4"  
(352381) **\$48**

**\$169**

**5'5"x7'7" Cameo  
Rose Area Rug**  
(786012)

1'11"x7'7"  
(497782) **\$69**

1'11"x3'4"  
(496170) **\$39**

**\$199**

**New 5'2"x7'6"  
Caldwell  
Area Rug** (339734)

1'11"x7'6"  
(339207) **\$79<sup>99</sup>**

1'11"x3'3"  
(339130) **\$39<sup>99</sup>**

**\$99**

**New 5'2"x7'6"  
Graffiti Area Rug**  
(340064)

1'11"x7'6"  
(340060) **\$34<sup>99</sup>**

1'11"x3'3"  
(339776) **\$19<sup>99</sup>**

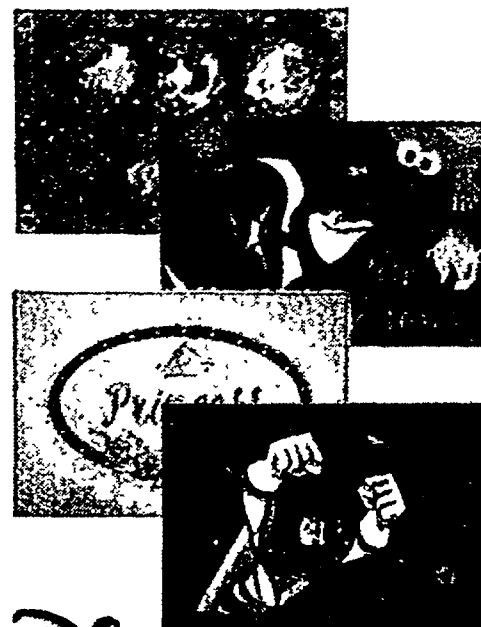

**Disney**

**4'11"x3'3"**

**Assorted Disney Rugs**

4 styles to choose from.

Durable nylon construction.

Foam, slip-resistant backing.

(209114) (209150) (209686) (210034)

**YOUR CHOICE**

**\$21<sup>97</sup>**

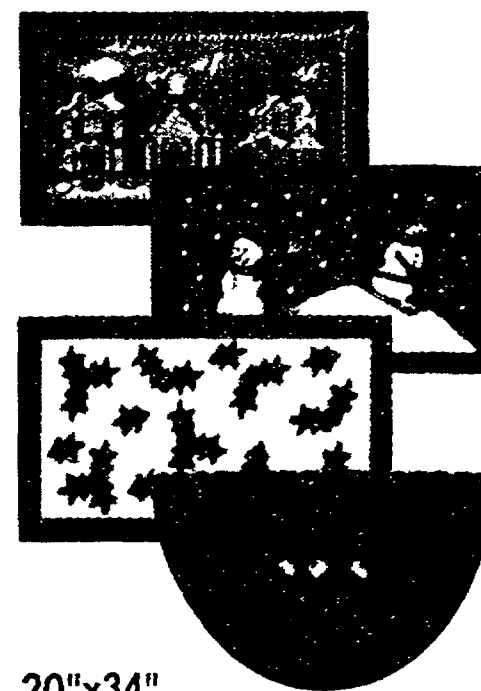

**20"x34"**

**Assorted Holiday Mats**

4 styles to choose from. Nonskid,  
latex backing. Washable nylon.

Only at The Home Depot.

(497172) (497186) (497205) (497419)

**YOUR CHOICE**

**\$9<sup>50</sup>**

**You can do it. We can help.**

Product availability may vary by store location.



- Auburn Hills.....(248) 393-1004
- Brighton.....(810) 229-0085
- Burton.....(810) 715-1700
- Canton.....(734) 844-7300
- Canton (South).....(734) 495-9414
- Caledonia Township.....(989) 723-7033
- Chesterfield Township.....(586) 948-1590
- Commerce.....(248) 624-0196
- Dearborn.....(313) 593-4644
- Dearborn Heights.....(313) 359-9600
- Detroit.....(313) 341-7750
- Farmington Hills.....(248) 737-3766
- Fenton.....(810) 714-2962
- Ft. Gratiot Township.....(810) 385-2932
- Flint Township.....(810) 230-8784
- Harper Woods.....(313) 245-9216
- Howell.....(517) 548-3742
- Lapeer.....(810) 245-3485
- Livonia.....(734) 458-4956
- Macomb Township.....(586) 463-3551
- Madison Heights.....(248) 591-7520
- Midland.....(989) 633-9381
- Mt. Pleasant.....(989) 779-1501
- Mundy Township.....(810) 232-7113
- North Flint.....(810) 230-6430
- Northland.....(248) 423-7777
- Northville.....(248) 347-9600
- Novi.....(248) 347-6746
- Orion Township.....(248) 393-9990
- Pittsfield Township.....(734) 975-1029
- Plymouth.....(734) 207-6147
- Pontiac.....(248) 253-8900
- Rochester Hills.....(248) 601-2643
- Roseville.....(586) 415-9620
- Saginaw.....(989) 249-1440
- Shelby Township.....(586) 992-0191
- Southfield.....(248) 423-0040
- Sterling Heights.....(586) 264-7866
- Taylor.....(734) 374-1901
- Troy.....(248) 816-8001
- Utica.....(586) 997-1411
- Warren.....(586) 757-3000
- West Saginaw.....(989) 781-3611
- White Lake Township.....(248) 698-4801
- Woodhaven.....(734) 671-4400

**EXPO** Troy.....(248) 689-3346  
 Utica.....(810) 726-1500  
 W. Bloomfield.....(248) 865-7590  
 Design Center



General merchandise prices may vary after 12/24/2004 if there are market variations (commodities excluded).

**\*Key Credit Terms**  
**No Payments, No Interest Credit Offers:**

■ Represents Stores with Tool Rental Centers. Tool Rental Center hours may vary from Store hours

**FINANCE CHARGES** accrue from the date of purchase and all accrued **FINANCE CHARGES** will be added to your Account for the entire promotional period if qualifying purchases, including premiums for optional credit insurance, are not paid in full before the end of the promotional period or if you fail to make any required payment on your Account when due. Deferred period may vary by offer. See specific offer for details.

With credit approval for qualifying purchases. See specific offer for qualifying terms. **APR** for purchases is **21%** and **15.48%** for purchases of \$2,000 or more on the Home Depot® Consumer Credit Card. The Default Rate **APR** for purchases of \$2,000 or more is **19%**. **Minimum Finance Charge** is **\$1.00**. **APR** for purchases is **17.99%** and **12.99%** for purchases of \$2,000 or more on the EXPO® Design Center Consumer Credit Card. The Default Rate **APR** for purchases of \$2,000 or more is **17.99%**. **Minimum Finance Charge** is **\$1.00**. See cardholder agreement for details. Offer is for individuals, not businesses.

**Estimated Monthly Payments:**

Payments shown are an estimate of your required minimum monthly payments, and assume that you have no existing balance, make no additional purchases, that you pay the minimum payment by the payment due date each month, and that you do not incur any additional fees. Actual minimum monthly payments may vary. These payments apply only to the Home Depot Consumer Credit Card.

We reserve the right to limit quantities to the amount reasonable for homeowners and our regular contractor customers. It is our policy to run truthful, accurate advertising. In the event of an error, we will make every reasonable effort to accommodate our customer. Details on any product warranty available at store. ©2004 Home TLC Inc.

Service provided by The Home Depot authorized independent installation professionals. Home Depot, U.S.A., Inc., license nos.: IA #91302-04; LEXINGTON/LAFAYETTE, KY #11517; MI #2102-119069; DETROIT #LIC2001-07767; MN #BC-20147263; OH-CLEVELAND HEIGHTS #3897, SHAKER HEIGHTS #4951; PA-PHILA #842, LANCASTER #2779, PLUMSTEAD #C04-2190; WI #940283. AE# 73054

# GET READY FOR

With help from



## Lifetime Warranty



**Superior Quality with Innovative Designer Colors**  
 Your richest color choices now come with a Lifetime Warranty!

FINISH	SKU	one gallon
Matte	(161264)	\$22 <sup>94</sup>
Eggshell	(220655)	\$24 <sup>94</sup>
Satin	(764066)	\$25 <sup>94</sup>
Semi-Gloss	(184348)	\$27 <sup>94</sup>

FREE How-to Clinic: You can have fun with colors and faux paint, Sundays at 2pm

# THE HOLIDAYS

America's largest color palette

Lifetime Guarantee



**BEHR® Premium Plus®  
Interior Enamel Paint**  
RATED THE BEST 2 YEARS IN A ROW!

FINISH	SKU	one gallon	SKU	five gallon
Flat	(135992)	\$18 <sup>97</sup>	(136433)	\$84 <sup>97</sup>
Flat Enamel	(366860)	\$19 <sup>97</sup>	(367484)	\$88 <sup>97</sup>
Eggshell	(347973)	\$19 <sup>97</sup>	(348031)	\$88 <sup>97</sup>
Satin	(894485)	\$20 <sup>97</sup>	(926948)	\$93 <sup>97</sup>
Semi-Gloss	(152390)	\$21 <sup>97</sup>	(152412)	\$97 <sup>97</sup>
Hi-Gloss	(985007)	\$23 <sup>97</sup>	(225583)	\$99 <sup>97</sup>

20-Year Warranty



**Glidden Evermore™  
Interior Latex Paint**  
Get a quality finish with extra covering power at a great value.

FINISH	SKU	one gallon	SKU	five gallon
Flat	(122178)	\$15 <sup>98</sup>	(122021)	\$70 <sup>98</sup>
Eggshell	(101137)	\$16 <sup>98</sup>	(101485)	\$75 <sup>98</sup>
Satin	(857599)	\$17 <sup>98</sup>	(968889)	\$79 <sup>98</sup>
Semi-Gloss	(968927)	\$18 <sup>98</sup>	(969001)	\$84 <sup>98</sup>
Hi-Gloss	(625179)	\$20 <sup>98</sup>		

12-Year Warranty



**Glidden America's Finest®  
Interior Latex Paint**  
Fast-drying latex formula offers easy application and cleanup.

FINISH	SKU	one gallon	SKU	five gallon
Flat	(561551)	\$9 <sup>97</sup>	(291613)	\$43 <sup>97</sup>
Satin	(562702)	\$11 <sup>97</sup>	(302445)	\$52 <sup>97</sup>
Semi-Gloss	(563213)	\$13 <sup>97</sup>	(303890)	\$61 <sup>97</sup>

**10% Off** All Custom DesignView Shadings and Cellular Window Treatments

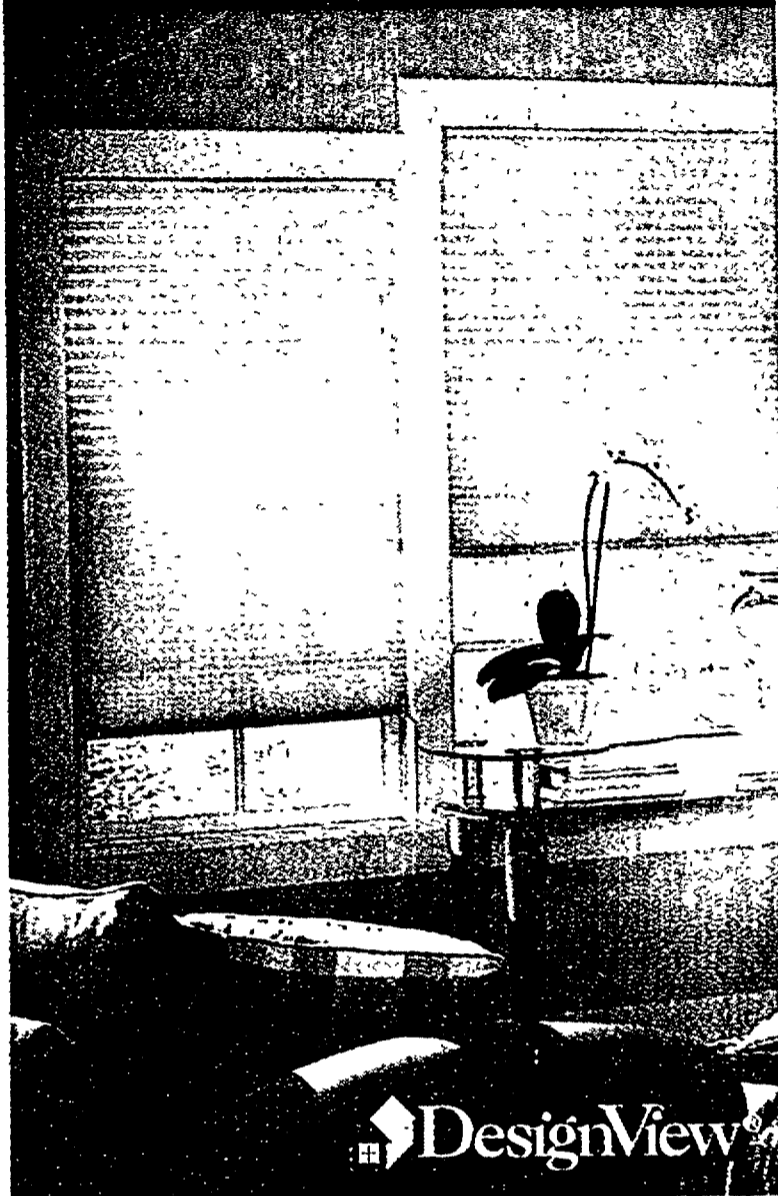

DesignView®

## Cellular Shades

These amazingly lightweight and versatile cellular shades are packed with energy efficient benefits you'll enjoy every season of the year. Discover an extensive selection of fabrics ranging from semi-opaque to blackout, offered in fabulous colors to achieve your specific needs for light control, insulation and decor perfection.

berber sand 0009

brownstone 0007

bayou 0031

coffee bean 0040

Offer valid 12/2/04 - 12/29/04 with the purchase of DesignView Shadings and Cellular Blinds. Offer valid in U.S. and Puerto Rico The Home Depot stores only. Free upgrade valance up to a \$149 value valid with the purchase of a DesignView 2" or 3" Custom Wood Blind only. Not valid at EXPO® Design Center. Promotion valid on special order product only, and does not apply to in-stock product or installation services. No credit if offer refused. See Store Associate for complete details.

You can do it. We can help.



72,101,64,67,115,120,121,131,135,136,137,138,139,140,141,142,143,144,145,146,147,148,149,150,151,152,153,154,155,156,157,158,159,160,161,162,163,164,165,166,167,168,169,170,171,172,173,174,175,176,177,178,179,180,181,182,183,184,185,186,187,188,189,190,191,192,193,194,195,196,197,198,199,200,201,202,203,204,205,206,207,208,209,210,211,212,213,214,215,216,217,218,219,220,221,222,223,224,225,226,227,228,229,230,231,232,233,234,235,236,237,238,239,240,241,242,243,244,245,246,247,248,249,250,251,252,253,254,255,256,257,258,259,260,261,262,263,264,265,266,267,268,269,270,271,272,273,274,275,276,277,278,279,280,281,282,283,284,285,286,287,288,289,290,291,292,293,294,295,296,297,298,299,300,301,302,303,304,305,306,307,308,309,310,311,312,313,314,315,316,317,318,319,320,321,322,323,324,325,326,327,328,329,330,331,332,333,334,335,336,337,338,339,340,341,342,343,344,345,346,347,348,349,350,351,352,353,354,355,356,357,358,359,360,361,362,363,364,365,366,367,368,369,370,371,372,373,374,375,376,377,378,379,380,381,382,383,384,385,386,387,388,389,390,391,392,393,394,395,396,397,398,399,400,401,402,403,404,405,406,407,408,409,410,411,412,413,414,415,416,417,418,419,420,421,422,423,424,425,426,427,428,429,430,431,432,433,434,435,436,437,438,439,440,441,442,443,444,445,446,447,448,449,450,451,452,453,454,455,456,457,458,459,460,461,462,463,464,465,466,467,468,469,470,471,472,473,474,475,476,477,478,479,480,481,482,483,484,485,486,487,488,489,490,491,492,493,494,495,496,497,498,499,500





**You can do it.  
We can help.™**

### Tree Service



■ We'll trim the trunk



■ We'll wrap the tree

### Florist Quality



**6-1/2" Poinsettia**  
A holiday decorating favorite  
Available in a variety of colors.  
(482919)  
**\$499**

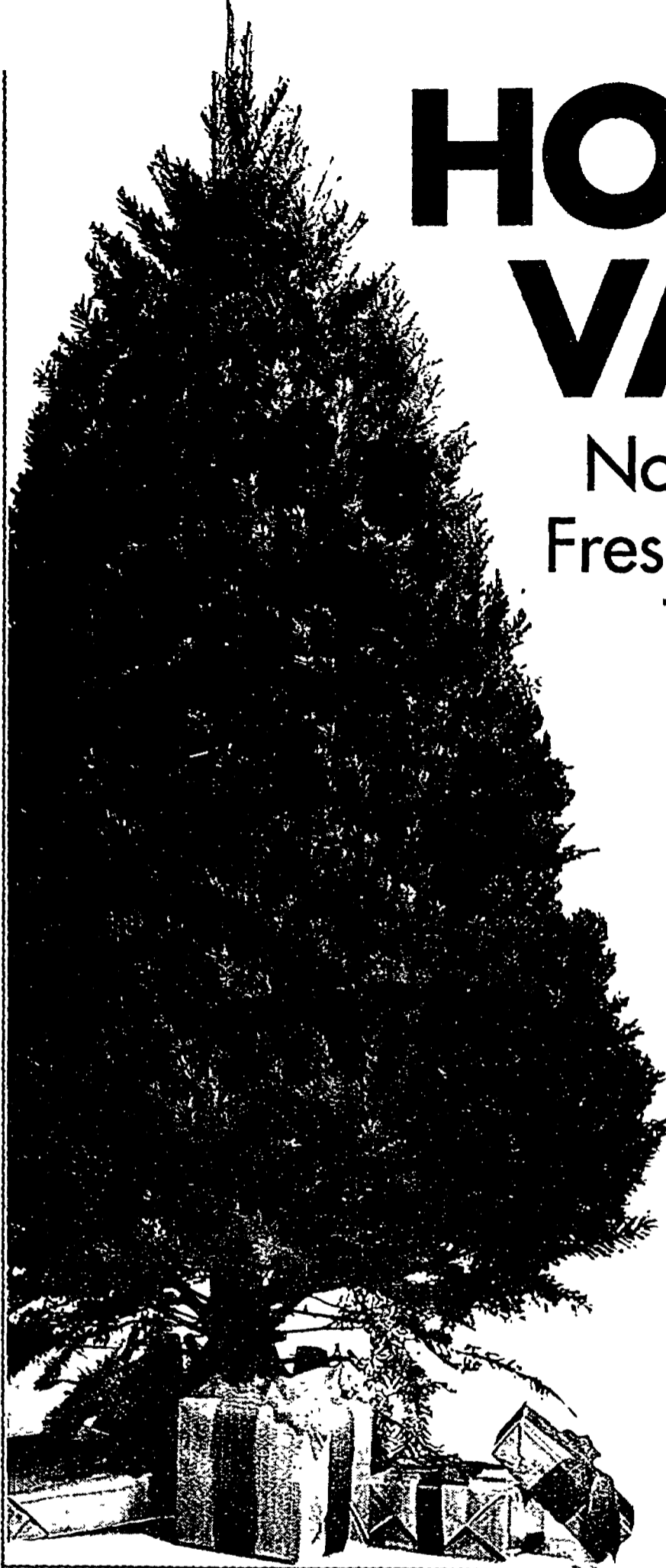

# HOLIDAY VALUES

**Nobody Sells More  
Fresh Cut Trees Than  
The Home Depot**

**6'-8' Douglas Fir**  
1" to 1-1/2" soft needles. Dense,  
cone-shaped appearance. (301132)  
**\$1996**

6'-8' Fraser Fir (912123) **\$3496**  
6'-8' Balsam Fir (554978) **\$2496**



**Never-Fail Small Tree Stand**  
Fits trees up to 7 ft. tall.  
**\$797** (677219)

Medium (547187) **\$1197**  
Fits trees up to 10 ft. tall.



**100 Light Count, Miniature  
Holiday Light Set**  
Available in clear, multi, red  
and blue bulbs. (846492)(846376)  
(158256)(158807)  
**\$162**



**Intermatic®  
Basic Plug-In Timer**  
TN111D86  
(283122)  
**\$495**



**24" Noble Fir Mixed  
Green Wreath**  
(794152)  
**\$1496**

**Give the Perfect Gift: The Home Depot Gift Card**

©2004 Potbelly Sandwich Works, Inc.



**Putting FREE SANDWICHES  
in the newspaper  
was getting messy,  
so we devised  
this handy postcard.**

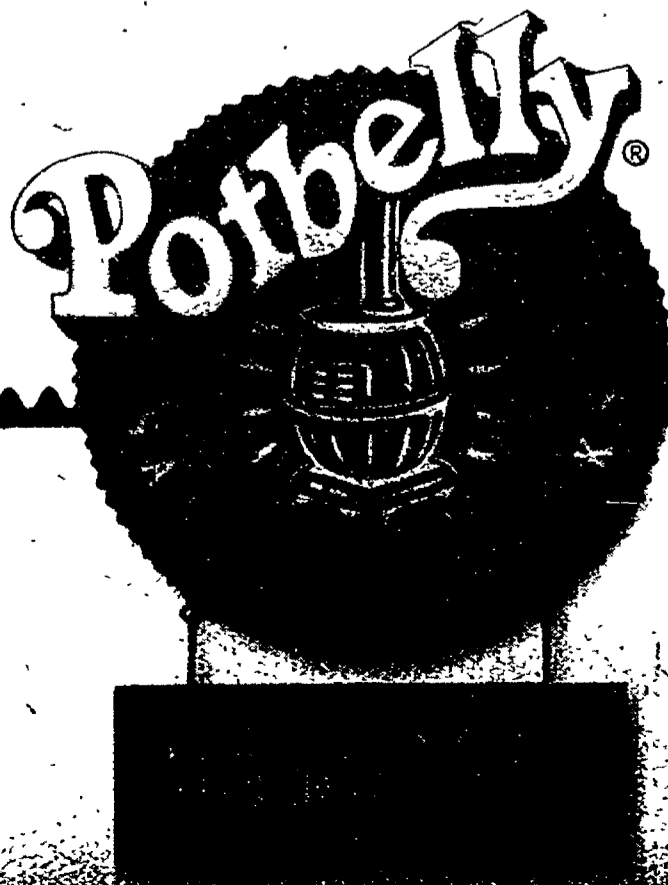

**NOW OPEN  
IN LIVONIA**

# Potbelly SANDWICH WORKS

ALL SANDWICHES ARE MADE TO ORDER AND SERVED WARM ON FRESH ROLLS WITH YOUR CHOICE OF MAYO, MUSTARD, HOT PEPPERS, LETTUCE, ONION, TOMATO, PICKLE, OIL & ITALIAN SEASONING.

## TURKEY BREAST

• WITH SWISS CHEESE

## ITALIAN

• CAPPICOLA, MORTADELLA, PEPPERONI, SALAMI & PROVOLONE CHEESE

## VEGETARIAN

• MUSHROOMS, SWISS, PROVOLONE & AMERICAN CHEESES

## A WRECK

• SLICED ROAST BEEF, TURKEY & SWISS WITH SWISS CHEESE

## PIZZA

• MARINARA SAUCE, PROVOLONE CHEESE, & ITALIAN SEASONING

• PEPPERONI OPTIONAL - ADD 50¢

## SMOKED HAM

• WITH SWISS CHEESE

## TUNA SALAD

• WITH SWISS CHEESE

## CHICKEN SALAD

• WITH PROVOLONE CHEESE

## MEATBALL SANDWICH

• MARINARA & PROVOLONE CHEESE

## ROAST BEEF

• THIN SLICED BEEF & PROVOLONE

## BIG JACK'S PBJ

• CREAMY PEANUT BUTTER

• ORANGE JELLY

## EXTRAS - 50¢ EACH

- MUSHROOMS
- CHEESE
- BACON
- OUNCE OF MEAT
- MARINARA

PEPPERS  
ON THE SIDE  
15¢

ALL \$3.79 + TAX

We're a new sandwich joint in town. A place that serves amazing sandwiches, hand-dipped shakes and even live, local music. And even better, we're giving you a...

# FREE SANDWICH!

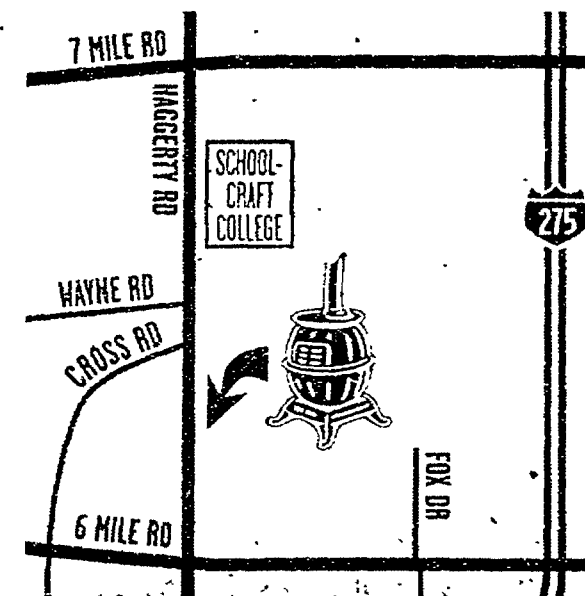

17374 HAGGERTY ROAD  
(Between 6 and 7 Mile)  
Ph: 734.432.0972

\* Usually the word free comes with a long list of disclaimers about how you really have to buy something else or mail in a card to get whatever was supposed to be free in the first place. Not this time. Bring this into the new Livonia Potbelly and you get a 100% free sandwich, with only the usual blah, blah, blah like: limit one per customer, you must be present to receive free food, and that old, legal favorite, offer expires 12/31/04. That's it. Now come in and enjoy that free sandwich.



# American Profile



## Pro Rodeo's Main Event

*It's a Wild Ride to the National Finals*  
Story on page 8

### INSIDE:

- Granville, N.D.
- Ben Franklin's legacy
- Oven-fried chicken
- Diet & diabetes
- Handy Hints
- Curing dental anxiety

ing Next Week:  
merican Profile  
p 'N' Save!  
COUPONS

HERO: Pastor Denny Bellesi pays it forward

280

# CMT HOMECOMING

Your story begins at home.

President Jimmy Carter talks about how a little town in Georgia prepared him for the world. And friend Willie Nelson performs live for the people of Plains, GA.

Premieres Dec 4th, 9/8c

27

A Man

Of

Incredible

Humanity

Got It

From

SOMEWHERE

ONLY ON  
CMT



# Ask American Profile

## Q Where is Tom T. Hall and what is he doing?

—Phil L., Indiana

The singer/songwriter from Olive Hill, Ky. (pop. 1,813), lives with his wife, who is known as Miss Dixie, in Franklin, Tenn. (pop. 41,842). Though Hall retired six years ago, he and his wife are still active musically. "We built an acoustic music studio on the farm and spend our time writing bluegrass songs and helping struggling young bands get a start in the music business," Hall, 68, says. The Halls recently received the International Bluegrass Music Association's distinguished service award for their work. The couple also has homes in Virginia and Florida and spends time traveling between them and writing songs along the way.



Miss Dixie and Tom T. Hall spend their days writing songs.

## A Year of Honors for Lou Rawls

Singer Lou Rawls, who turns 69 on Dec. 1, has received three major honors this year, but he's showing no signs of slowing down anytime soon. In August, he received an honorary doctorate from Wilberforce University, the nation's oldest, private historically black college that's just outside of Dayton, Ohio. "That was unbelievable," Rawls says. "Growing up in Chicago, I was aware of Wilberforce University because every year they would have the Tuskegee-Wilberforce football game. That was something we looked forward to." In September, he received a Lifetime Achievement Award at the Temecula Valley International Film and Music Festival in Temecula, Calif. (pop. 57,716). In October, he attended the grand opening of the Lou Rawls' Center for the Performing Arts at Florida Memorial College in Miami. "I still don't know how to deal with it," Rawls says. "It's something I consider a great honor and privilege." Rawls lives in Scottsdale, Ariz., with his wife, Nina. "I'm always touring," he says. "As long as they call, I'm in business. I'm in the process of getting together another album, but that takes time because I don't like to just rush in and do something without preparing." The father of three will release his 82nd album next year.



Soulful singer Lou Rawls



Katrina Elam's debut CD is out now.

## Q I am an old fan of Wallace Beery. Can you give me some information about him? I am interested in titles to some movies he was in long ago.

—Helen C., Maryland

The beloved character actor made some 220 movies, but none were as colorful as his own life. Born in Kansas City, Mo., in 1885, he joined the Ringling Brothers Circus at 16 as an elephant trainer. Two years later, he left after a leopard attacked and clawed his arm. From musical variety shows in New York, he segued to screen work in the Sweedie comedies, where he met first wife Gloria Swanson. In 1931, he won a best actor Oscar for *The Champ*, and went on to memorable roles in 1933's *Dinner at Eight* and 1934's *Treasure Island*. He died from a heart attack in 1949 at age 64. ☆

\* Cover photo by PRCA/Dan Hubbell

## We want to know what you think

Become a member of our American Profile Online Reader Advisory Panel. It's an easy way for you to tell us about features, stories and ideas to help us produce the best magazine we can.

To become a member, log on to <http://www.americanprofile.com/panel>.

## Q I went to a Country Gold concert that featured Katrina Elam. Can you tell me anything about her?

—Jason P., Iowa

The 20-year-old singer from Bray, Okla. (pop. 1,035), released her first album, called *Katrina Elam*, in October. A born performer, Elam showed the world that she could belt out a song when she took the stage at a local 4-H talent show at age 9. She never stopped singing after that, and moved to Nashville, Tenn., at age 17 to pursue a career. "It was weird going from a town where everybody knows each other to a place where nobody knows you at all," she says. Now she's got a single on the radio and is touring with Keith Urban. "I was doing a show in Kansas City, Mo., singing my single, and I looked out and saw a woman singing along! To think someone knew the words to my song already was so cool."

# American Profile

Celebrating Hometown Life

PRESIDENT & CEO

Richard G. Porter

PUBLISHER

Tracey Altman

EXECUTIVE EDITOR

Charlie Cox

Senior Editor: Stuart Englert

Editor: Richard McVey

Entertainment Editor: Beverly Keel

Assistant Editor: Candace Floyd

Art Director: Brenan Sharp

Photo Editor: David Mudd

Production Manager: Sam Payne

Traffic Coordinator: Susan Fisher

Manager of Internet Content: Matt Johnston

ADVERTISING SALES

New York 1-800-716-6271

Los Angeles 1-800-716-6271

Chicago 1-800-708-5669

Detroit 1-866-773-0388

Nashville 1-800-720-6323

Director of Marketing

Jeff Dunetz

Direct Response Advertising

Katherine Zito,

David Geller Associates, Inc.

1-877-543-5537

CIRCULATION SALES

Vice President/Publisher Relations: Jerry Lyles

Nashville 1-800-720-6323

CORPORATE AND EDITORIAL OFFICES

Nashville 615-468-6000

PUBLISHING GROUP OF AMERICA

President & CEO

Richard G. Porter

Chief Financial Officer & COO

Stephen C. Duggan

Vice President/Controller

Greg Coble

Network Administrator: Mike Olin

[www.americanprofile.com](http://www.americanprofile.com)

PUBLISHING GROUP OF AMERICA

American Profile is published by: Publishing Group of America, 341 Cool Springs Boulevard Suite 400, Franklin, Tennessee 37067 Phone: 1-800-720-6323. Mail editorial queries and contributions to Editor, American Profile, 341 Cool Springs Blvd., Suite 400, Franklin, TN 37067. Publishing Group of America, Inc. will not be responsible for unsolicited materials, and cannot guarantee the return of any materials submitted to it. ©2004 Publishing Group of America, Inc. American Profile™ is a trademark of Publishing Group of America, Inc. All rights reserved. Reproduction in whole or part of any article, photograph, or other portion of this magazine without the express written permission of Publishing Group of America, Inc. is prohibited.

Allow 4-6 weeks for delivery

Only \$6.95 Each Plus \$3.00 S&H

# A Great Sticking Stuffer!

1-800-851-5284

central

both



# HOLIDAY HEADQUARTERS

AT YOUR LOCAL  
**DOLLAR GENERAL**

OVER 7,000 Locations To Serve You!



**DOLLAR GENERAL**  
**\$10**  
SPECIAL PURCHASE

32"  
FIBER OPTIC  
TREE

32 CT. VALUE PACK  
CHRISTMAS CARDS  
YOUR CHOICE

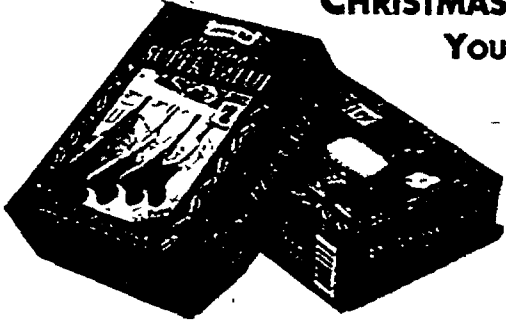

**DOLLAR GENERAL**  
**\$2**  
SPECIAL PURCHASE

**DOLLAR GENERAL**  
**\$1**  
SPECIAL PURCHASE

35 INDOOR MULTI LIGHTS

35 CT. MULTI OR CLEAR LIGHTS  
YOUR CHOICE



ASSORTED  
WIRE EDGE RIBBON OR  
40 SQ. FT. WRAPPING PAPER  
YOUR CHOICE



**DOLLAR GENERAL**  
**\$1**  
SPECIAL PURCHASE

**NOW ACCEPTING BANK DEBIT CARDS &**



NOVUS

**DOLLAR GENERAL**  
**\$3**  
SPECIAL PURCHASE

ASSORTED  
WEE TEEN  
DOLLS  
YOUR CHOICE  
SELECTION VARIES  
BY STORE



ASSORTED CHRISTMAS  
CHILDREN'S VIDEOS  
YOUR CHOICE

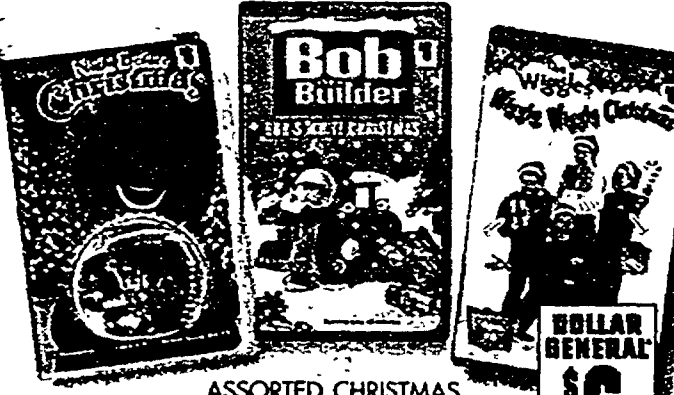

**DOLLAR GENERAL**  
**\$6**  
SPECIAL PURCHASE

ELECTRONIC KEYBOARD  
37 KEYS, LIGHT SYSTEM, STEREO SOUND



**DOLLAR GENERAL**  
**\$10**  
SPECIAL PURCHASE

BATTERY OPERATED  
SUPER RACING  
OVER 2 FEET OF TRACK!



**DOLLAR GENERAL**  
**\$10**  
EVERY DAY.

**DOLLAR GENERAL**  
**\$4**  
SPECIAL PURCHASE

38 oz.  
POPCORN  
TIN  
3 FLAVORS



16 CT. PEPPERMINT  
CANDY CANES OR  
8 OZ. CHOCOLATE COVERED CHERRIES  
YOUR CHOICE, VARIETIES MAY VARY BY STORE



**DOLLAR GENERAL**  
**\$1**  
SPECIAL PURCHASE

ASSORTED  
8 PK. FAMILY SOCKS  
OR MEN'S 5 PK. WHITE BRIEFS  
FRUIT OF THE LOOM® OR HANES®  
YOUR CHOICE



**DOLLAR GENERAL**  
**\$5**  
EVERY DAY.

**DOLLAR GENERAL**  
**\$6**  
SPECIAL PURCHASE

JERZEES  
FRUIT & LOGO

ADULT FLEECE  
TOPS OR BOTTOMS  
ASSORTED COLORS  
YOUR CHOICE



OTHER FLEECE:  
YOUTH \$5  
PLUS SIZE \$7.50

**DOLLAR GENERAL**  
**\$1**  
SPECIAL PURCHASE

ASSORTED CHRISTMAS  
KITCHEN TOWELS,  
OVEN MITTS OR  
POTHOLDERS  
YOUR CHOICE



**DOLLAR GENERAL**  
**\$3**  
EVERY DAY.

COOKIE PAN OR  
BAKE/ROAST PAN  
YOUR CHOICE



**DOLLAR GENERAL**  
**\$8**  
EVERY DAY.

2 PK. CAMERA  
WITH FLASH  
SINGLE USE



DG GUARANTEE 8 PK.  
AAA OR AA  
ALKALINE BATTERIES  
YOUR CHOICE



**DOLLAR GENERAL**  
**\$2.50**  
EVERY DAY.

All items sold on a first come basis. All styles & colors shown may not be available in all stores. Early sell out possible on special purchase items. We reserve the right to limit quantities. No rain checks available. Not responsible for typographical errors. ©2004 Dollar General Intellectual Property, LP. All Rights Reserved.

Health

# Diet & Diabetes

## Chefs discuss menu choices and challenges

Cooking for a living is demanding work that involves long hours in the kitchen, tasting food to make sure dishes are properly prepared, and little time to eat wholesome meals. So when a professional chef is diagnosed with diabetes, the challenge is to adapt without trading good health for the pleasures of a rewarding career.

"I can tell you coping with it isn't difficult, but it is all up to you," says Harry Brockwell, 66, a retired restaurant owner and caterer who lives in Westlake Village, Calif. (pop. 8,368).

Brockwell, who was diagnosed with diabetes in 1980, says living with diabetes boils down to personal responsibility. That's why

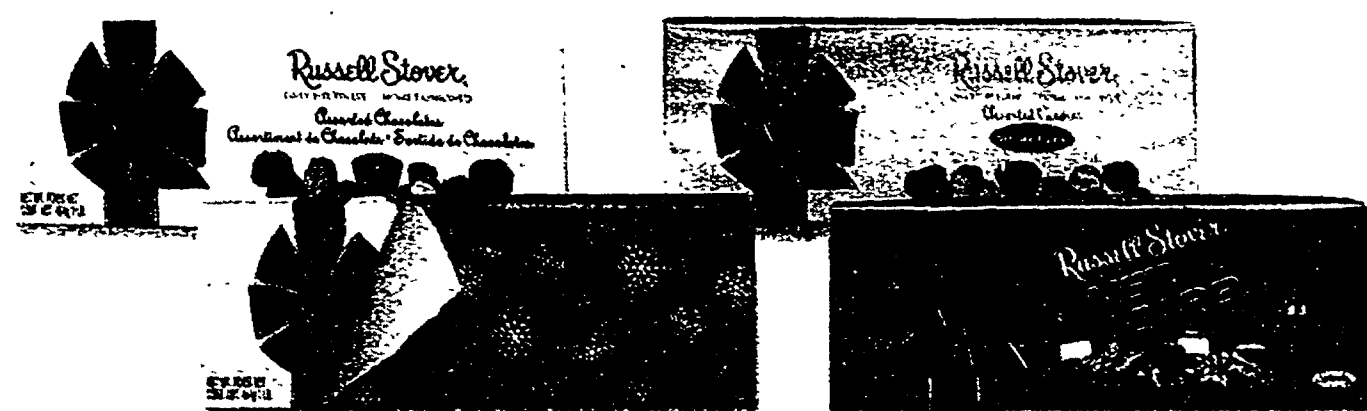

Russell Stover has been making the holidays sweeter since 1923. Just a few of our many handcrafted classic, sugar free and net carb gift ideas.



Elvis and Elvis Presley are Registered Trademarks with Elvis Presley Enterprises, Inc. © 2004 Elvis Presley Enterprises, Inc.  
TM & © Warner Bros. Entertainment, Inc. (6/04)

# Russell Stover

Shop for your favorites at [www.russellstover.com](http://www.russellstover.com)  
Free Shipping with your purchase of \$30 or more.

© Russell Stover Candies 2004

each day, he takes his medication, checks his blood sugar, walks two miles and builds meals around fresh fruits, vegetables and lean meats. And when it comes to cravings, he says, indulge them, but be reasonable.

"I walk by an ice cream place and it calls my name," Brockwell says jokingly. "If you're craving something, have it but eat a small portion."

The 18.2 million people in the United States with diabetes have the same nutritional needs as everyone else. However, because their bodies don't produce or properly use insulin, a hormone needed to convert sugar, starches and other foods into energy, what they eat—and in what quantities—is particularly important. Eating well-balanced meals in the correct amounts can keep blood glucose levels close to normal. That can reduce the chances of developing diabetes-related side effects such as heart disease, stroke, high blood pressure, blindness and nerve damage.

### Making smart choices

Having diabetes doesn't prevent chef Michael Tibbs from preparing the steak and seafood meals that his customers order at Farley's Restaurant in Scranton, Pa.

"For me, having diabetes and being healthy is all a matter of attitude," says Tibbs, 46, who was diagnosed with the disease at age 22. "I'm not going to let diabetes stop me from doing what I love, and I love to cook."

In the kitchen, Tibbs balances the business of sampling what he prepares into his daily calorie count. To curb the urge to snack, he always eats breakfast and includes plenty of protein in all meals.

Eating out, even for a chef, can require some forethought. "Choose places that fit in your meal plan," Tibbs says, explaining how that may mean trading a fried fish restaurant for one where it's broiled or steamed.



Photo: Getty Images

"I choose chicken instead of pasta, and I plan ahead so I know what I'm eating fits into my plan," he adds. "Passing on alcohol eliminates empty calories."

The goal, he says, is to balance food and exercise so that the calories eaten and burned average out. "At one time, I'd have ordered an appetizer, soup, entrée and dessert," Tibbs says. "Now I just order the entrée. Diabetes is really about making smart choices." ☆

*Mardy Fones is a freelance writer in Nashville, Tenn.*

**L**iving well with diabetes doesn't require special cooking or a restrictive diet. Both Brockwell and Tibbs recommend these tips for healthful cooking and eating:

- Read food labels to avoid excess sugar, fat and carbohydrates.
- When baking, substitute applesauce for refined sugar.
- Use bouillon instead of heavy cream when making sauces.
- Select low-fat cheeses and use them in modest quantities.
- Flavor dishes with lemon or orange juice instead of butter.
- Season salads, vegetables and meats with fresh herbs and spices.
- Include small quantities of flaxseed oil, which contain heart-healthy omega 3 fatty acid, to soups and casseroles.
- Try new food preparation techniques, such as smoking meats and roasting vegetables.
- Make salad dressings with flavored vinegars, a touch of low-fat ricotta cheese and fresh garlic, plus small quantities of healthful oils such as peanut or olive oil.
- Include whole grains, which are believed to help reduce bad cholesterol, such as barley and oatmeal to soups and casseroles.

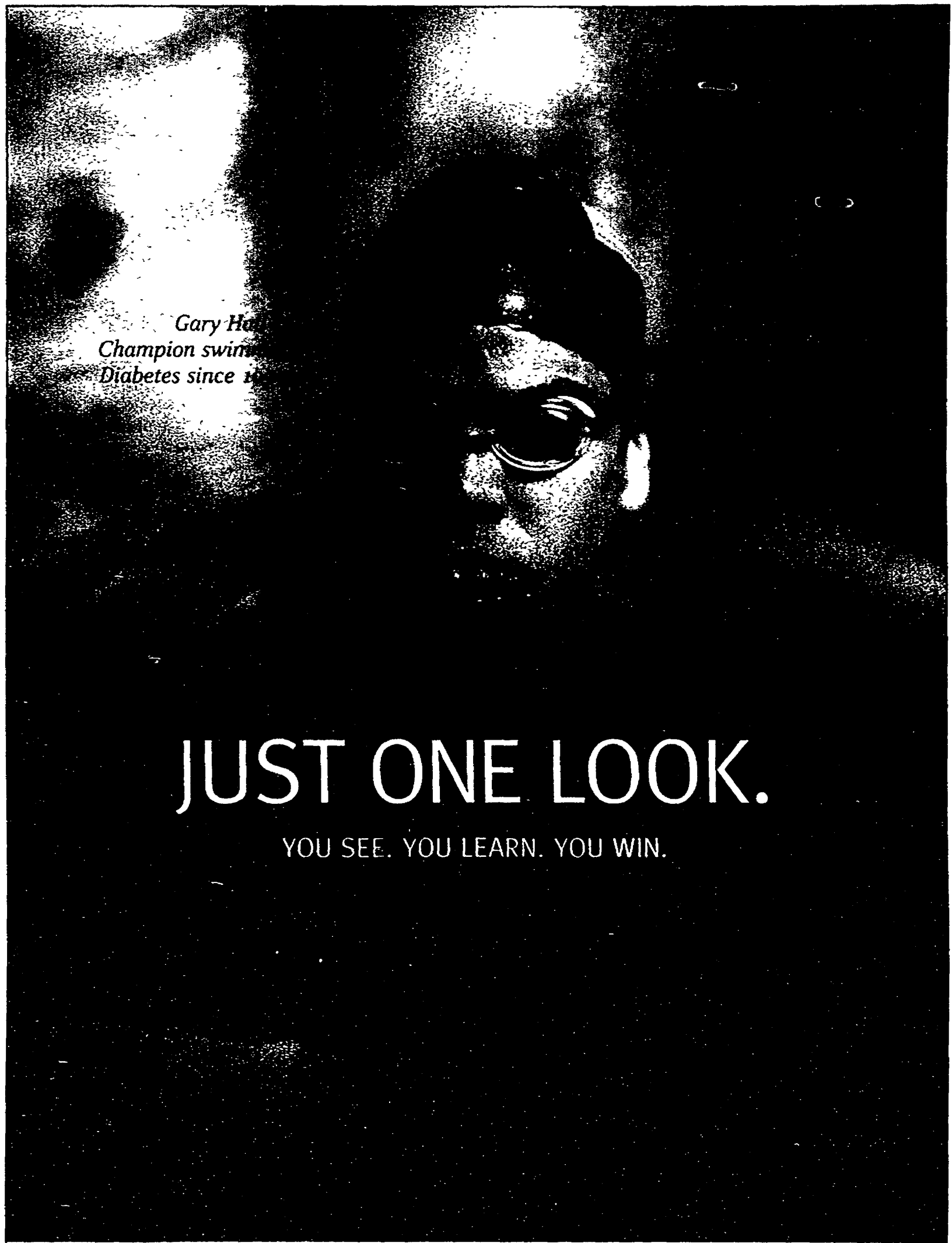

Gary Hall Jr.  
Champion swimmer  
Diabetes since 1998

# JUST ONE LOOK.

YOU SEE. YOU LEARN. YOU WIN.

With every test, the OneTouch® UltraSmart® meter helps Gary Hall Jr. learn more about his diabetes. Charts and graphs make it simple to see patterns and trends.

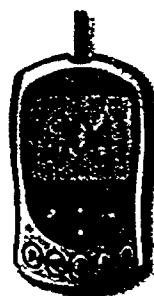

Patterns

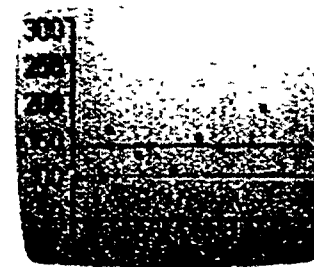

Trends

[www.OneTouchUltraSmart.com](http://www.OneTouchUltraSmart.com)  
or 1-800-227-8862  
for more information





Photo: Las Vegas News Bureau

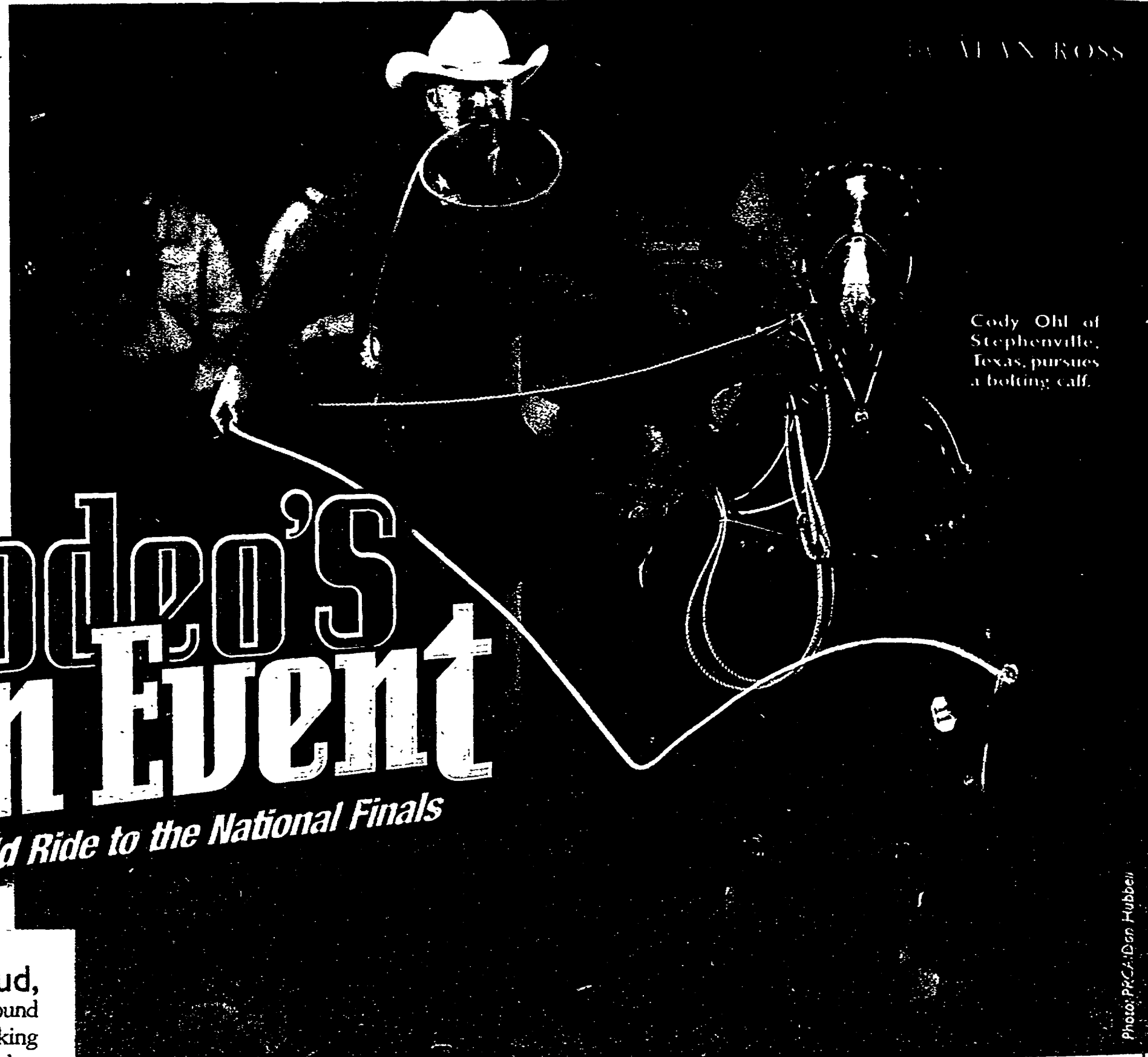

Cody Oll of Stephenville, Texas, pursues a bolting calf.

# Pro Rodeo's Main Event

*It's a Wild Ride to the National Finals*

Their names — Howdy Cloud, Blue Stone, Buster Record and Rope Myers—sound like a roll call from the silver screen era of smoking six-shooters and singing cowboys. And while they may not fill movie theaters with a ruthless pursuit of law and order, these Hollywood-sounding cowhands are showing up more and more on television, upholding one of the West's most venerable traditions: the sport of rodeo.

After years in the saddle, any of the 7,500 Professional Rodeo Cowboys Association (PRCA) competitors who contend for prize money and a shot at a world-champion title can tell you, it's a wild ride to the Wrangler National Finals Rodeo (NFR).

"What I'd hoped would happen 30 to 35 years ago is finally becoming a possibility now," says Shawn Davis, 64, production manager for the PRCA's three nationwide tours, plus the prestigious National Finals, the sport's equivalent of baseball's World Series. "We have nearly 700 sanctioned rodeos annually in 41 states and four Canadian provinces. There's a beginning and an end and a tremendous excitement level. Now we have a way of following a leader and knowing who's going on to compete at the NFR."

For rodeo athletes, the National Finals is the sport's crown jewel. Culminating each December at the Thomas & Mack Center in Las Vegas, the NFR pits the year's top 15 money earners in seven events: bareback bronc riding, steer wrestling, saddle bronc riding, barrel racing, tie-down roping, team roping,

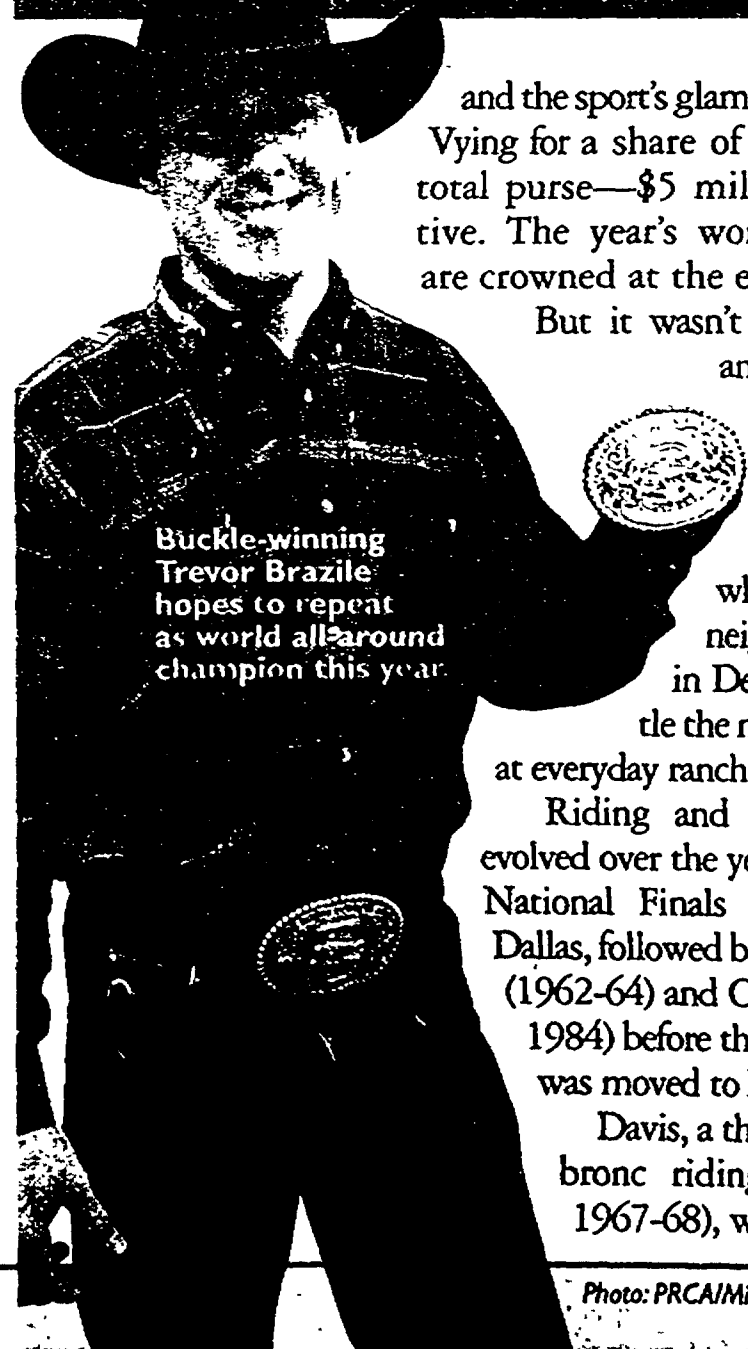

Buckle-winning Trevor Brazile hopes to repeat as world all-around champion this year.

and the sport's glamour event: bull riding. Vying for a share of the season's largest total purse—\$5 million—is the incentive. The year's world champions also are crowned at the event.

But it wasn't always Vegas glitter and big bucks for rodeo cowboys. The sport's origins took root, the PRCA claims, as far back as 1864, when hands from two neighboring ranches met in Deer Trail, Colo., to settle the matter of who was best at everyday ranching chores.

Riding and roping competitions evolved over the years. In 1959, the first National Finals Rodeo was held in Dallas, followed by stints in Los Angeles (1962-64) and Oklahoma City (1965-1984) before the championship event was moved to Las Vegas in 1985.

Davis, a three-time world saddle bronc riding champion (1965, 1967-68), who still coaches rodeo

at the College of Southern Idaho in Twin Falls, says the sport has changed considerably from the time when he was competing.

"When I was growing up, it was more like the original Wild West," recalls Davis, "when the cowboys would come into town, go to the rodeo, and then party and have a great time until the next one down the road a week. Their lifestyle has changed, too. More of them are family-oriented, and the younger guys work out like athletes and plan their careers. The participants before and through my era were more there for a good time and not as serious about their future."

## Man with a plan

Two-time defending PRCA world all-around champion Trevor Brazile is a man with a plan. Having won his first world all-around title in 2002, Brazile mapped out a goal to repeat in 2003, carefully selecting which rodeos to enter and working to improve his performance in the three roping events he concentrates on.

(Continued on page 10)

Photo: PRCA/Mike Copeman

Photo: PRCA/Dan Hubbell

GRAB LIFE BY THE HORNS

DODGE



## TIME TO PUT ANOTHER NOTCH IN THE TOOL BELT.

**DODGE RAM HEAVY DUTY.** As if an available best-in-class 610 lb-ft of torque and 16,300 lb towing capability\* isn't enough, Ram Heavy Duty was just named Highest Ranked Heavy-Duty Full Size Pickup in Initial Quality by J.D. Power and Associates. But that's all in a day's work, coming from the longest-lasting family of pickups. For more info, visit [www.dodge.com](http://www.dodge.com) or call 1-800-4ADODGE

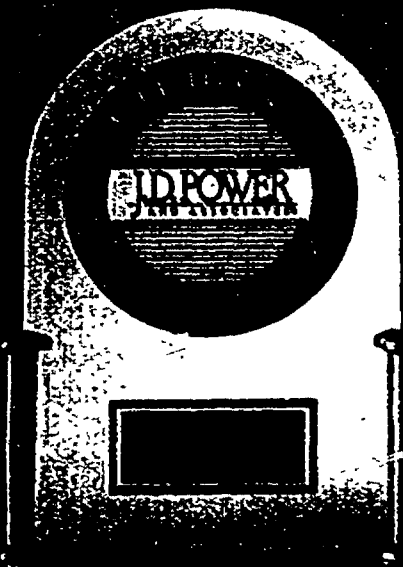

Chrysler Financial

RAM HD

(Continued from page 8)

"What I've learned most," says Brazile, 28, from Decatur, Texas, "is if you set your goals to make the finals, you might make the finals. But if you set your goals to win the world, you're definitely going to make the finals."

That a rodeo cowboy's life is tough is a given. The rigors of travel as well as tension of competition make for wear and tear on all competitors. Jim Shoulders, one of the sport's living legends from the 1940s and '50s, recalls the early days of rodeoing and the incessant demands of touring.



"You got a lot of freight tied up in yourself—a whole lot of miles—if you rodeoed," says Shoulders, 76, a 16-time world champion from Henryetta, Okla. "These guys talk about staying in condition and lifting weights. I've had people ask me how I stayed in shape. I say, 'Learn to get a good night's sleep in about 30 minutes.' That's what you had to do, because you spent so much time on the road getting to the rodeos."



Photo: PRCA/Kerri Tuckness

Legend Jim Shoulders

But as the saying goes, the more things change the more they stay the same. With respect to rodeo, Shoulders replies: "The rules basically are the same: You ride with one hand, and whoever rides the best bronc or the best bull and makes the best ride gets the money."

Not that there haven't been significant changes since Shoulders' era. The seven-time world bull riding champion is crystal clear about the sport's biggest transformation.

Barrel racer Jackie Dube celebrates a winning score.

"Starts with an 'm' and ends with a 'y,'" he says. "They call it money. I always said that if (legendary saddle bronc rider) Casey Tibbs was riding today, he'd be getting the money. But some of them making a living rodeoing back then couldn't get on their high school rodeo team today."

In the first of his five world all-around champion years, 1949, Shoulders took home \$21,495. By comparison, 2003 all-around titlist Brazile earned \$294,839, thanks in part to corporate sponsorships from beer, boot and blue jean manufacturers.

Still, incomes of full-time rodeo athletes haven't kept pace with those of professional baseball, football and basketball players, whose annual earnings have rocketed into the multi-millions.

"We're getting a lot of benefit out of television," says Davis, referring to the PRCA's contracts with the ESPN and OLN networks.

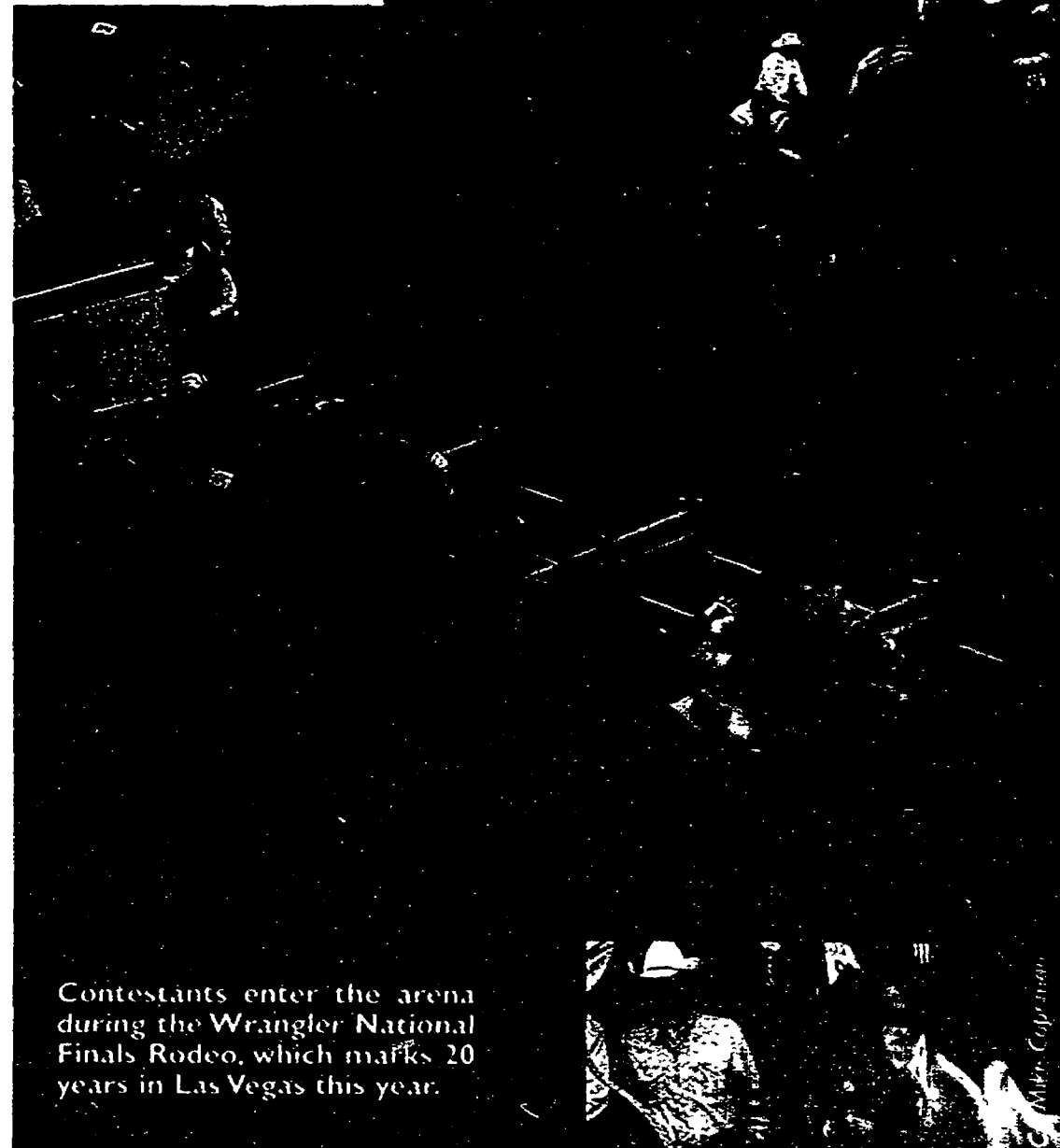

Contestants enter the arena during the Wrangler National Finals Rodeo, which marks 20 years in Las Vegas this year.

### Pay to play

One peculiarity of rodeo, unlike other professional sports, is the requirement that contestants pay entry fees to participate in each event—after they've fueled their trucks and hauled their horses to a distant county fairground.

"It's absurd," says Joe Beaver, 39, an eight-time world champion from Huntsville, Texas. "We're making tons of money for towns and rodeos, and we're getting just a very, very small share of it back. The expense to make the money is unbelievable."

Yet, despite its flaws, pro rodeo is making large strides, thanks to that most persuasive of media.

"If it's not on TV, it don't work," Shoulders adds. "I think it's a product worth selling and worth looking at."



A rambunctious bull takes Zack Brown of Chico Hills, Calif., for a ride.

As for what the future holds for pro rodeo, Davis says, "If they'll continue with the present (PRCA) commissioner's plan and organize it so it can be developed as a sport with a following, there's an excitement level coupled with the heritage of the West that is very hard to duplicate."

Brazile applauds the direction the PRCA is taking, bringing the top cowboys in front of a TV audience on a consistent basis: "I think that's improving our fan base."

This week, rodeo fans will once again turn their attention to Las Vegas and the much-awaited National Finals Rodeo. Among rodeo's superstars taking center stage will be Brazile, who will attempt to repeat as world all-around champion for the third consecutive year.

"The mental part is so hard," he says. "You've got so many outside factors that can drain you. But you have to keep going, no matter what. Our season doesn't wait on circumstances and for everything to be lined up perfect."



Photo: PRCA/Dan Hibbet



Office of National Drug Control

**~~"Because you don't take the time to meet my friends, you don't know that Krystal and Stefany are a couple of friends from school that I get high with."~~**

Get to know their friends, and you won't have to wonder if you're getting the whole story. You'll know that you are. Monitoring is important, because if you don't, your **PARENTS.** kids are four times more likely to do drugs. It isn't easy. But it's worth it. THE ANTI-DRUG

To learn more, call 1-800-788-2800. Or visit [theantidrug.com](http://theantidrug.com)



An Elvis impersonator was among 180,000 fans who attended the revered 10-day event last year.

Rodeo's No. 1 cowboy pauses before offering a final thought. "It doesn't matter what you've done at the previous rodeos," he says. "You've got to start new every time." ✨

*Alan Ross is a freelance writer from Bisbee, Ariz.*

The Wrangler National Finals Rodeo is scheduled Dec. 3-12. For more information, log on to [www.prorodeo.com](http://www.prorodeo.com).

#### Rate This Story

How did you like this story? Log on to [www.fox.com](http://www.fox.com)

## Hometown Hero

# Pay It Forward

"Dream with me," Pastor Denny Bellesi asked members of his church's Missions Outreach team. And they did, giving him \$10,000 in church funds and the go-ahead for a project that would reach far beyond one pastor and one parish.

The year was 2000, and Bellesi, founding pastor of Coast Hills Community Church in Aliso Viejo, Calif. (pop. 40,166), had just watched *Pay It Forward*, a movie about a boy challenged by a teacher to change the world. "I was about to begin a series on stewardship," he says. "The timing was perfect."

That November, Bellesi handed out \$100 each to 100 members of his church. Referring to the biblical parable of the talents, he told them, "You must use this money to further God's kingdom, and you must give an accounting and report in 90 days." Through the program designated "The Kingdom Assignment," parishioners applied their talents and turned the \$10,000 into more than \$500,000—and helped scores of people in the process.

Parishioner Terry Zwick matched the \$100 with \$100 of her own money and asked friends celebrating a birthday at a restaurant to do the same. When she left the party, Zwick not only had \$1,800, but also the name of a woman who was in need of financial help. Zwick helped the woman pay her rent and purchase Christmas gifts for her children.

Zwick also went beyond the initial project by overseeing the development of Hope's House, a shelter that helps families get back on their feet.

"From all the positive attention and great excitement from the Kingdom Assignment, it gave me an already prepared platform to share our dream for a women and children's shelter," she says.

When Bellesi arranged the second Kingdom Assignment in 2001, he invited parishioners to sell something and bring the money to the church, a project that raised \$120,000 for the county's poor.

by CAROLE MARSHALL  
Photos by John Hayes

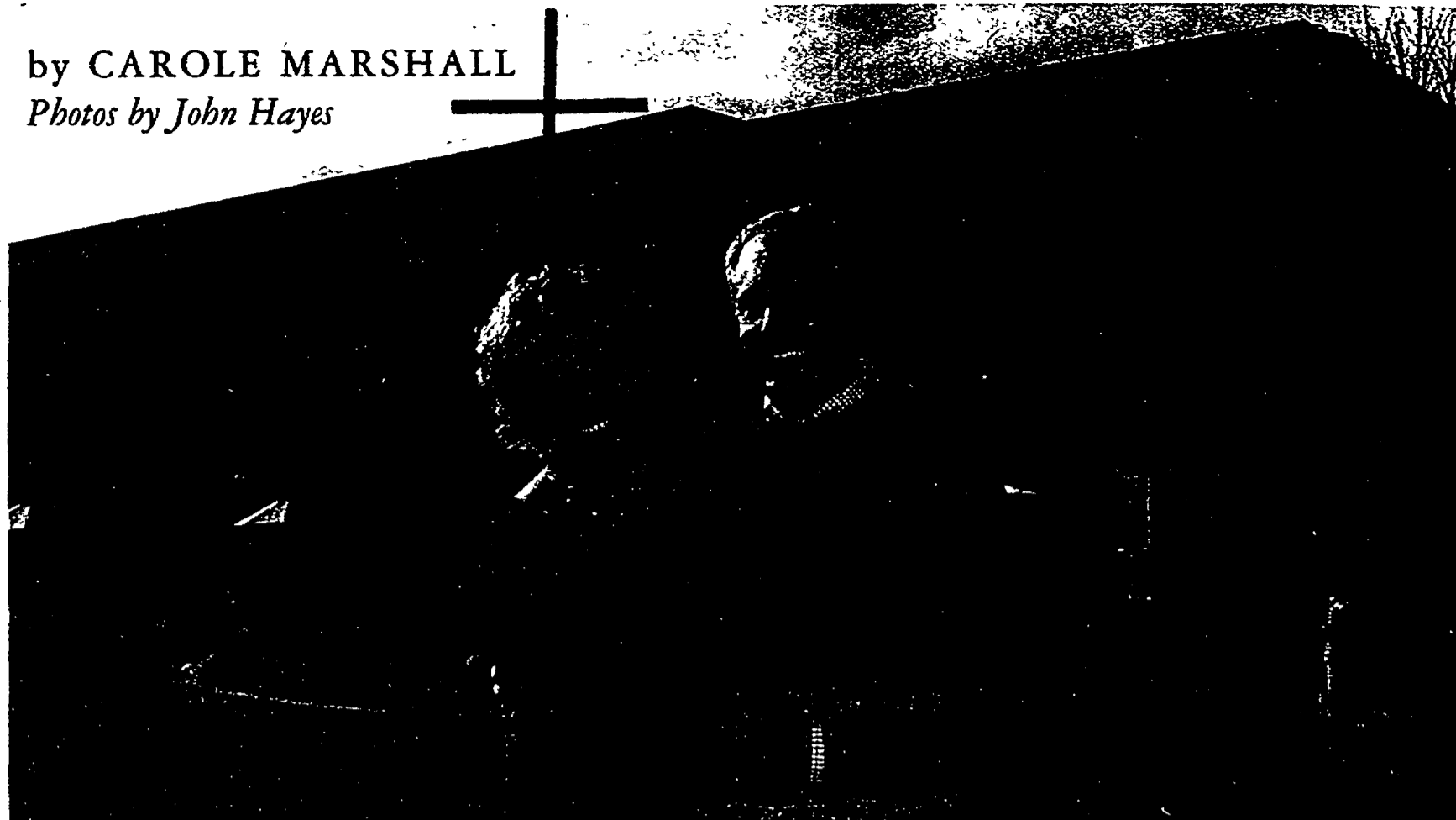

Pastor Denny Bellesi and wife Leesa multiply charity and compassion at the Coast Hills Community Church in Aliso Viejo, Calif.

Church members Lou and Tamara Spampinato sold clothing, lamps and a dresser. "It's enabled my husband and me to really use this as a teaching experience for our two children as well," Tamara says.

Also as part of the second assignment, Bellesi again handed out \$100 each to 100 church members. Some chose immediately to invest their \$100 in good works by buying food certificates or aiding specific families. Others figured a way to multiply their money to provide toys for a children's hospital, goodies for senior center residents and camp scholarships for disadvantaged children.

One of the most affecting accomplishments was purchasing and repairing a home for a single mother, made possible through donations of materials, services and the real estate agent's commission that went toward the home's selling price. "I think the point is to empower the people to think outside the box in their endeavors to advance God's kingdom," Bellesi says.

For the third Kingdom Assignment at Coast Hills Community Church, Bellesi asked for his parishioners to offer their time—to give 90 minutes in 90 days to someone the Scripture refers to as "the least of these."

"Giving doesn't take a lot of money," Zwick says. "All it takes is compassion for someone in need."

Indeed, compassion is part of her husband's make-up, Leesa Bellesi says. He is a "humble servant," she says of her husband of 30 years.

"When people work together, they are building upon a combination of gifts and talents that opens the floodgates for more results, if and when they work together and in cooperation to accomplish a common purpose," Denny Bellesi says.



The Bellesis talk and pray with a church beneficiary.

The Bellesis have written two books—*The Kingdom Assignment* and *The Kingdom Assignment 2*—based on some of the experiences of the first two assignments. A third book is in the works. "With the books, we've gotten people all over the world doing Kingdom Assignments," Leesa says.

Today, Bellesi and his church members are continuing on with their charitable ways.

"Our people have taken this from success to significance," Bellesi says. "It has become a total lifestyle for our church." ☆

Carole Marshall is a frequent contributor to American Profile.

Log on to [www.kingdomassignment.com](http://www.kingdomassignment.com) for more information.

### Rate This Story

How did you like this story? Log on to [www.kingdomassignment.com](http://www.kingdomassignment.com) to rate it.

Members of the congregation have used their gifts and talents to spread the wealth and inspirational message of kindness.



# "My 8-pound Oreck XL®. It cleans the air as you vacuum your floors!"



**SAND DISAPPEARS. PET HAIR IS GONE. DUST AND DUST MITES ARE HISTORY AND YOU'LL BREATHE EASIER KNOWING IT'S AN ORECK XL.**

Hi, I'm David Oreck. It's common knowledge that household dust carries germs, pollen, dander, mold spores, bacteria — things you don't want your family breathing in. That's why I've created the 8-pound Oreck XL. It's the standard by which all other vacuums will be judged.

Because in performance, ease of use, reliability, durability and value for your money, it stands alone. Add in a 50% improvement in air filtration and it's easily one of the most advanced vacuum cleaners money can buy. It picks up everything in one sweep, and then traps

99.99% of all harmful allergens down to 0.3-

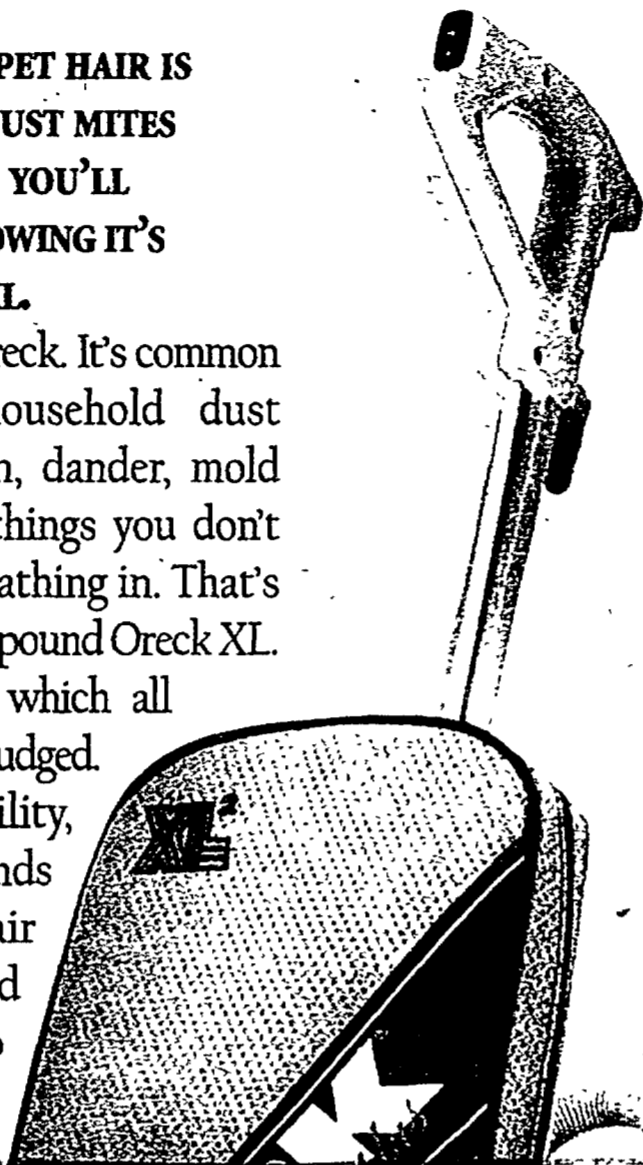

**SAVE TIME AND ENERGY THE ORECK WAY.**

My 8-pound Oreck XL lets you breeze through housework. Stairs are a snap. You glide from room to room. And you'll use 1/3rd the electricity of-virtually any other brand. In fact, an Oreck XL might actually pay for itself over its lifespan in energy savings.

**3 FREE TUNE-UPS AND A 10-YEAR HOUSING WARRANTY.**

My Oreck XL guarantee is so incredible, you'll wish your car had it. Odds are you'd go through three other vacuums in the time you own one Oreck XL. I'll also give you 3 free tune-ups to keep it running like new. That's a \$90 savings. Who else offers all that? But that's not all.

**TRY IT FREE AND THIS \$130 IRON IS YOUR FREE GIFT.**

My Cordless Iron is yours to keep when you try my amazing 8-pound vacuum in your own home free for 30 days. There's no obligation. I pay all shipping! Even the phone call is free.

**Free \$130 Iron!**  
Just for trying my



## NEW

### INTRODUCING THE BOSE® WAVE® MUSIC SYSTEM.

**PERFORMANCE** everyone can recognize.

**SIMPLICITY** everyone can appreciate.

**ELEGANCE** that speaks for itself.

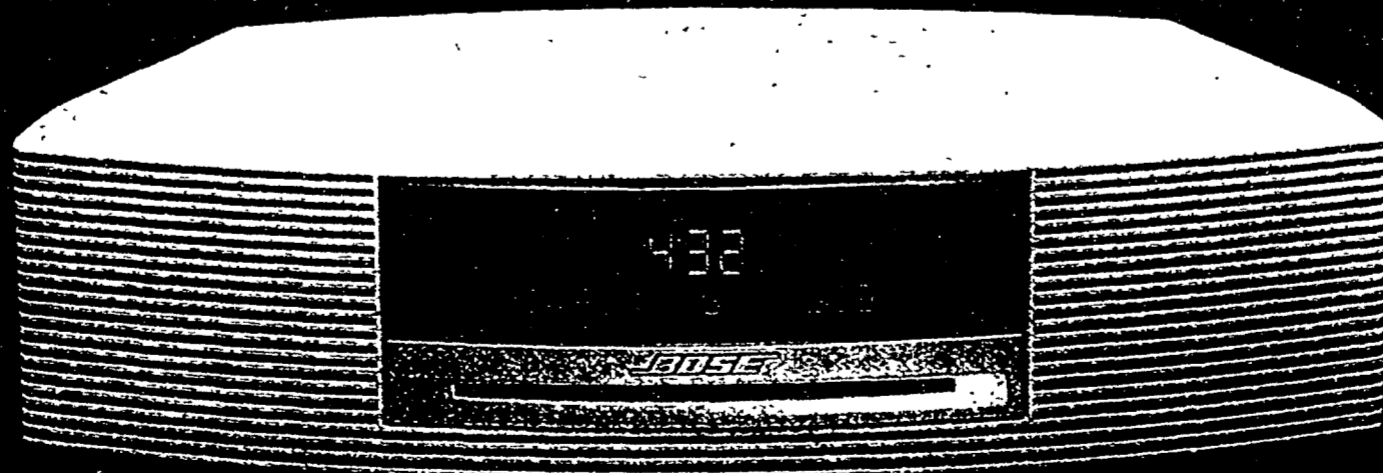

**BOSE**  
Better sound through research.



## Hometown Hero

# Pay It Forward

"Dream with me," Pastor Denny Bellesi asked members of his church's Missions Outreach team. And they did, giving him \$10,000 in church funds and the go-ahead for a project that would reach far beyond one pastor and one parish.

The year was 2000, and Bellesi, founding pastor of Coast Hills Community Church in Aliso Viejo, Calif. (pop. 40,166), had just watched *Pay It Forward*, a movie about a boy challenged by a teacher to change the world. "I was about to begin a series on stewardship," he says. "The timing was perfect."

That November, Bellesi handed out \$100 each to 100 members of his church. Referring to the biblical parable of the talents, he told them, "You must use this money to further God's kingdom, and you must give an accounting and report in 90 days." Through the program designated "The Kingdom Assignment," parishioners applied their talents and turned the \$10,000 into more than \$500,000—and helped scores of people in the process.

Parishioner Terry Zwick matched the \$100 with \$100 of her own money and asked friends celebrating a birthday at a restaurant to do the same. When she

by CAROLE MARSHALL  
Photos by John Hayes



Pastor Denny Bellesi and wife Leesa multiply charity and compassion at the Coast Hills Community Church in Aliso Viejo, Calif.

Church members Lou and Tamara Spampinato sold clothing, lamps and a dresser. "It's enabled my husband and me to really use this as a teaching experience for our two children as well," Tamara says.

Also as part of the second assignment, Bellesi again handed out \$100 each to 100 church members. Some chose, immediately to invest their \$100 in good works by buying food certificates or aiding specific families. Others figured a way to multiply their money to provide toys for a children's hospital, good-

ies for senior center residents and camp scholarships.

Indeed, compassion is part of her husband's make-up, Leesa Bellesi says. He is a "humble servant," she says of her husband of 30 years.

"When people work together, they are building upon a combination of gifts and talents that opens the floodgates for more results, if and when they work together and in cooperation to accomplish a common purpose," Denny Bellesi says.

## THE NEW BOSE® WAVE® MUSIC SYSTEM.

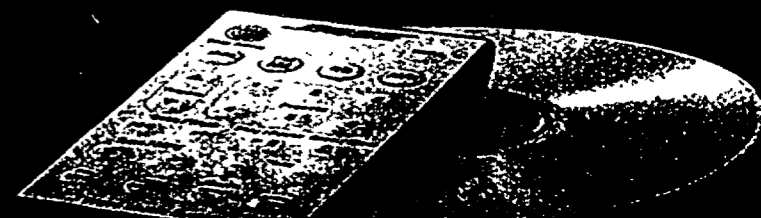
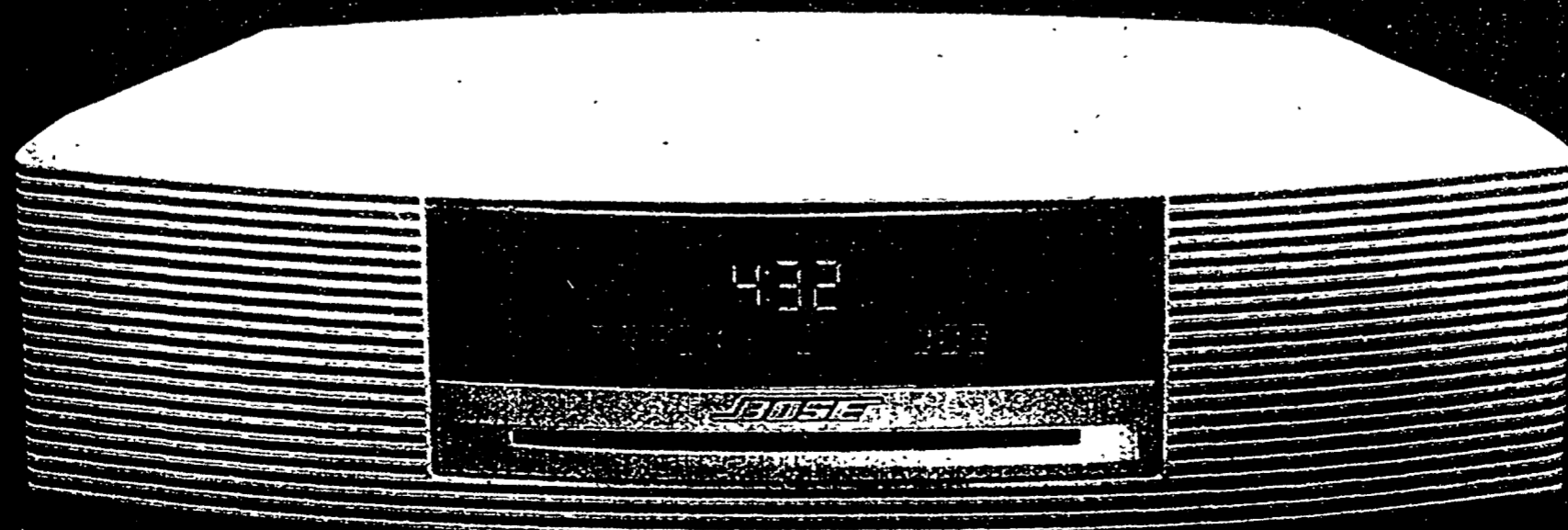

# "My 8-pound Oreck XL®. It cleans the air as you vacuum your floors!"



**SAND DISAPPEARS. PET HAIR IS GONE. DUST AND DUST MITES ARE HISTORY AND YOU'LL BREATHE EASIER KNOWING IT'S AN ORECK XL.**

Hi, I'm David Oreck. It's common knowledge that household dust carries germs, pollen, dander, mold spores, bacteria — things you don't want your family breathing in. That's why I've created the 8-pound Oreck XL. It's the standard by which all other vacuums will be judged.

Because in performance, ease of use, reliability, durability and value for your money, it stands alone. Add in a 50% improvement in air filtration and it's easily one of the most advanced vacuum cleaners money can buy. It picks up everything in one sweep, and then traps 99.99% of all harmful allergens down to 0.3

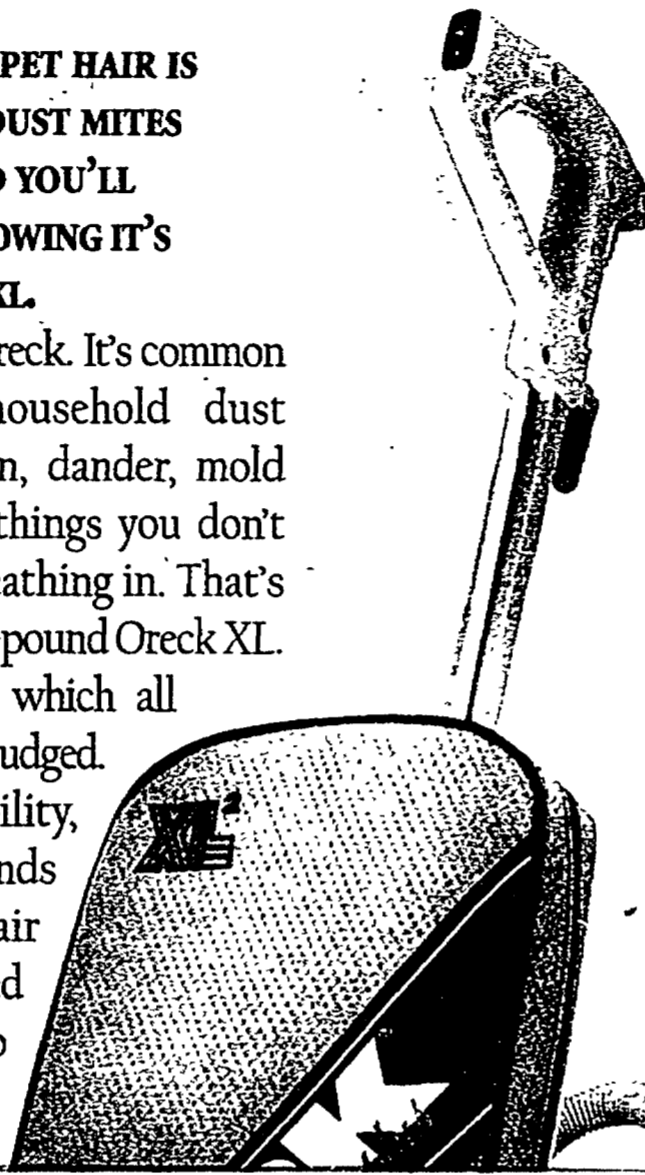

**SAVE TIME AND ENERGY THE ORECK WAY.**

My 8-pound Oreck XL lets you breeze through housework. Stairs are a snap. You glide from room to room. And you'll use 1/3rd the electricity of-virtually any other brand. In fact, an Oreck XL might actually pay for itself over its lifespan in energy savings.

**3 FREE TUNE-UPS AND A 10-YEAR HOUSING WARRANTY.**

My Oreck XL guarantee is so incredible, you'll wish your car had it. Odds are you'd go through three other vacuums in the time you own one Oreck XL. I'll also give you 3 free tune-ups to keep it running like new. That's a \$90 savings. Who else offers all that? But that's not all.

**TRY IT FREE AND THIS \$130 IRON IS YOUR FREE GIFT.**

My Cordless Iron is yours to keep when you try my amazing 8-pound vacuum in your own home free for 30 days. There's no obligation. I pay all shipping! Even the phone call is free.

**Free \$130 Iron!**

**Just for trying my**

**ITS HERITAGE** *Popular Science* called the original Bose Wave radio "a sonic marvel." The *Chicago Tribune* said its sound was "superb." And *Forbes ASAP* magazine placed it on their "All-Time A-List" of technology breakthroughs that have changed the world. Now, the award-winning predecessor has been engineered to a new standard of performance, simplicity, and elegance.

## ITS NEW PERFORMANCE

- Reproduces one-half octave lower musical notes.
- Produces even greater instrument clarity and definition.
- Plays the newer MP3 CDs as well as conventional CDs and of course, FM/AM radio.
- It may well become the primary music system in your home.

## ITS NEW SIMPLICITY

- No buttons!
- It is completely and conveniently controlled by a small, elegant remote control.

## ITS NEW ELEGANCE

- The original model has been repeatedly praised for its distinctive design. The new model has carried this design to an unprecedented level with the absence of all buttons.

**IT COMES WITH A 30-DAY EXCITEMENT GUARANTEE.** During this risk-free trial period please compare, side by side, the sound of your new Bose Wave music system to that of larger and more expensive sound systems owned by you or your friends. You will appreciate our request when you make this comparison.

**FREE shipping with your order.**

**TO ORDER OR FOR INFORMATION CALL 1-800-901-0231, ext. TD737**  
Be sure to ask about our financing options.

For information on all our products:  
**www.bose.com/td737**

**BOSE**  
Better sound through research.

## Hometown Hero

# Pay It Forward

"Dream with me," Pastor Denny Bellesi asked members of his church's Missions Outreach team. And they did, giving him \$10,000 in church funds and the go-ahead for a project that would reach far beyond one pastor and one parish.

The year was 2000, and Bellesi, founding pastor of Coast Hills Community Church in Aliso Viejo, Calif. (pop. 40,166), had just watched *Pay It Forward*, a movie about a boy challenged by a teacher to change the world. "I was about to begin a series on stewardship," he says. "The timing was perfect."

That November, Bellesi handed out \$100 each to 100 members of his church. Referring to the biblical parable of the talents, he told them, "You must use this money to further God's kingdom, and you must give an accounting and report in 90 days." Through the program designated "The Kingdom Assignment," parishioners applied their talents and turned the \$10,000 into more than \$500,000—and helped scores of people in the process.

Parishioner Terry Zwick matched the \$100 with \$100 of her own money and asked friends to do the same.

by CAROLE MARSHALL  
Photos by John Hayes



Pastor Denny Bellesi and wife Leesa multiply charity and compassion at the Coast Hills Community Church in Aliso Viejo, Calif.

Church members Lou and Tamara Spampinato sold clothing, lamps and a dresser. "It's enabled my husband and me to really use this as a teaching experience for our two children as well," Tamara says.

Also as part of the second assignment, Bellesi again handed out \$100 each to 100 church members. Some chose immediately to invest their \$100 in good works by buying food certificates or aiding specific families. Others figured a way to multiply their

Indeed, compassion is part of her husband's make-up, Leesa Bellesi says. He is a "humble servant," she says of her husband of 30 years.

"When people work together, they are building upon a combination of gifts and talents that opens the floodgates for more results, if and when they work together and in cooperation to accomplish a common purpose," Denny Bellesi says.

## THE NEW BOSE® WAVE® MUSIC SYSTEM.

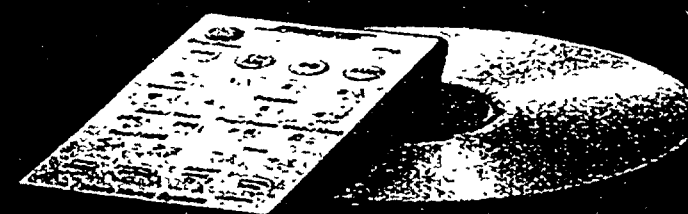
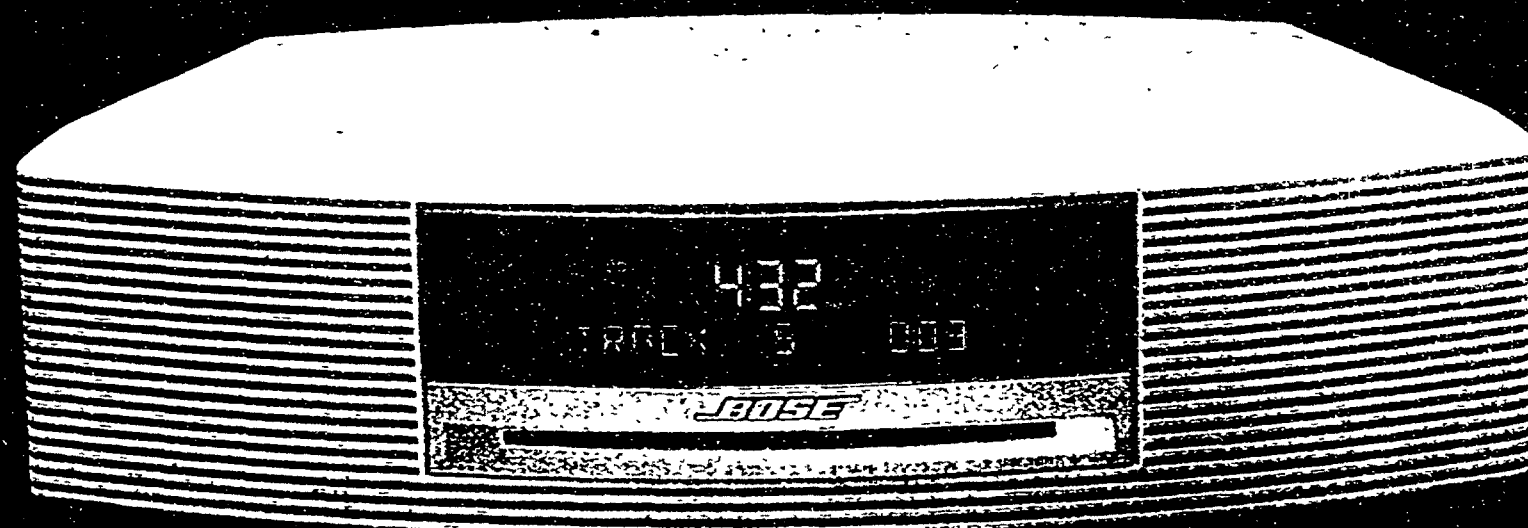

FREE  
shipping with  
your order.

TO ORDER OR FOR INFORMATION CALL  
**1-800-901-0231**, ext. TD737

Be sure to ask about our financing options.

For information on all our products: [www.bose.com/td737](http://www.bose.com/td737)

**BOSE**  
Better sound through research



# "My 8-pound Oreck XL®. It cleans the air as you vacuum your floors!"

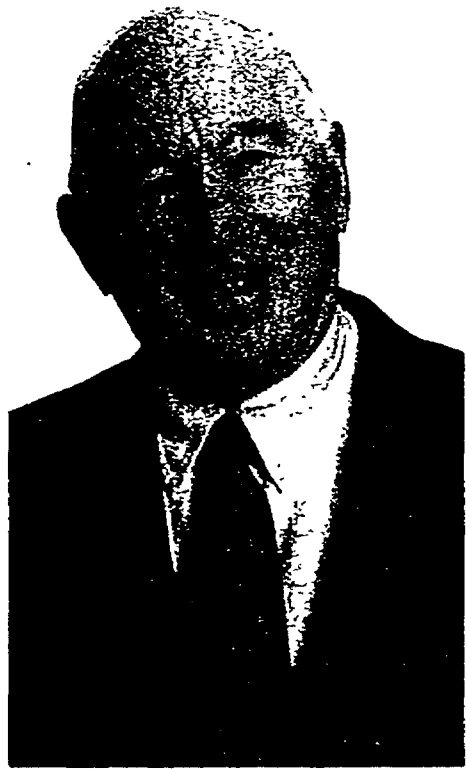

**SAND DISAPPEARS. PET HAIR IS GONE. DUST AND DUST MITES ARE HISTORY AND YOU'LL BREATHE EASIER KNOWING IT'S AN ORECK XL.**

Hi, I'm David Oreck. It's common knowledge that household dust carries germs, pollen, dander, mold spores, bacteria — things you don't want your family breathing in. That's why I've created the 8-pound Oreck XL. It's the standard by which all other vacuums will be judged.

Because in performance, ease of use, reliability, durability and value for your money, it stands alone. Add in a 50% improvement in air filtration and it's easily one of the most advanced vacuum cleaners money can buy. It picks up everything in one sweep, and then traps 99.99% of all harmful allergens down to 0.3 microns. That's 1/250th the width of a human hair. (Bacteria measures 0.4 to 10 microns. Mold spores are 10 to 100 microns.) There's never a cloud of dust in your face, or foul odor with my XL Upright! I guarantee it.

**WITH ORECK, YOU GET A COMPLETE SYSTEM.**

Free with purchase of the XL is my \$165 hypo-allergenic Compact Canister. It's great for ceilings, furniture, closets, and it's a great car vac, too. It's Strong Enough To Pick Up A 16-lb. Bowling Ball.™

Try it free, and we'll pay the shipping. A \$29.95 value!

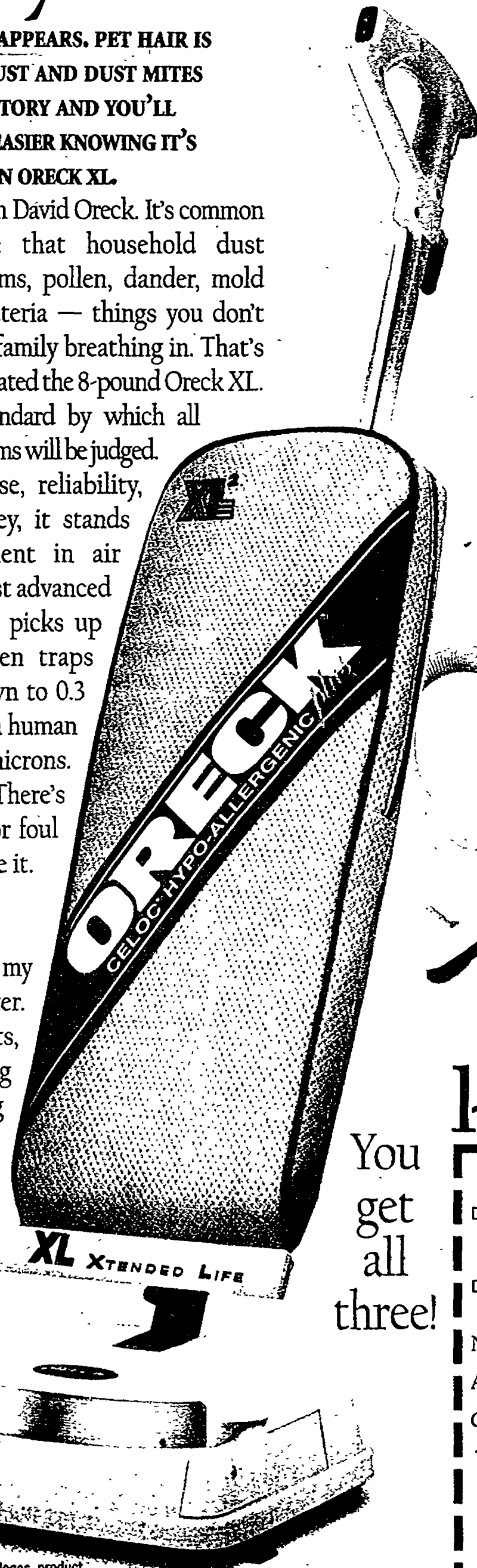

You get all three!

**SAVE TIME AND ENERGY THE ORECK WAY.**

My 8-pound Oreck XL lets you breeze through housework. Stairs are a snap. You glide from room to room. And you'll use 1/3rd the electricity of virtually any other brand. In fact, an Oreck XL might actually pay for itself over its lifespan in energy savings.

**3 FREE TUNE-UPS AND A 10-YEAR HOUSING WARRANTY.**

My Oreck XL guarantee is so incredible, you'll wish your car had it. Odds are you'd go through three other vacuums in the time you own one Oreck XL. I'll also give you 3 free tune-ups to keep it running like new. That's a \$90 savings. Who else offers all that? But that's not all.

**TRY IT FREE AND THIS \$130 IRON IS YOUR FREE GIFT.**

My Cordless Iron is yours to keep when you try my amazing 8-pound vacuum in your own home free for 30 days. There's no obligation. I pay all shipping! Even the phone call is free.

Free \$130 Iron!  
Just for trying my Oreck XL Upright.



Free \$165 Compact Canister Vac

For everything above the floor, my Oreck 5-pound Compact Canister is yours free with purchase of an amazing 8-pound Oreck XL.

**1-800-755-9805 ext. CN908**

**Free 30-Day Home Trial**

CN908

- Please call me to arrange a free 30-day trial of the Oreck XL® and send me a \$130 Oreck Cord Free Speed Iron™ just for trying the XL. I understand I will receive the Compact Canister free with purchase and the shipping (a \$29.95 value) is free.
- Yes, I would like more information on the amazing 8-pound Oreck XL, and include details of Oreck's 12-month Interest Free Payment Plan.

Name \_\_\_\_\_

Address \_\_\_\_\_

City \_\_\_\_\_ State \_\_\_\_\_ Zip \_\_\_\_\_

Tel( ) \_\_\_\_\_ e-mail \_\_\_\_\_

optional Call 1-800-755-9805 or visit [oreck.com](http://oreck.com)

**ORECK**  
Nothing gets by an Oreck.®

Oreck Direct, LLC 100 Plantation Road, New Orleans, LA 70123

**LAST  
CHANCE  
THIS YEAR!**

**100% Wash  
and Wear!**

Oatmeal



Fluffy polyester & acrylic berber fleece is lusciously warm! And ooh—it's washable too! Choose from beautiful Oatmeal & Tan 2-tone or solid colors with corded trim detailing. 2 inside pockets, satiny silk & nylon lining, even a hidden drawstring in the waist! So snugly & warm — under \$30 and FREE Postage if you order now!

# BERBER FLEECE JACKET

**29<sup>99</sup>**  
each

**FREE  
POSTAGE**  
ON THIS ORDER



Berber Fleece  
**JACKET 29<sup>99</sup>\***  
each  
2 for 55.40 3 for 80.75

Haband 1600 Pennsylvania Avenue, Peckville, PA 18452  
Send \_\_\_ jackets. I enclose \$ \_\_\_\_\_ **FREE Postage!**  
purchase price plus ~~\$4.05~~ toward postage.

Misses Sizes: S(6-8) M(10-12) L(14-16)	☺ <b>9M2-D5904</b>	WHAT SIZE?	HOW MANY?
*Women's Sizes (just \$5 more each): XL(18-20W) 2XL(22-24W) 3XL(26-28W)		02 TAN	
	JR OATMEAL		
	01 BLACK		

Check  Visa  MasterCard  Discover/NOVUS\*  AmEx

Card # \_\_\_\_\_ Exp.: \_\_\_\_/\_\_\_\_/\_\_\_\_

Mr. Mrs. Ms. \_\_\_\_\_

Address \_\_\_\_\_ Apt. # \_\_\_\_\_

City & State \_\_\_\_\_ Zip \_\_\_\_\_

100% Satisfaction Guaranteed or Full Refund of Purchase Price at Any Time!

**Haband!**  
Duke Habernickel, Pres.  
1600 Pennsylvania Avenue  
Peckville, PA 18452

Imported

**1-800-543-4810 haband.com**

## Hometown Recipes

from LINDA T. BIGGS

# Oven-Fried Chicken

"This is simple to make but is so good. A good friend gave this recipe to me awhile ago and I've made it many times." ☆

Coming  
Next  
Week!

American Profile  
Clip 'N' Save!  
COUPONS

RECIPE: Oven-Fried Chicken

American Profile

Linda T. Biggs  
Somerset, Ky.

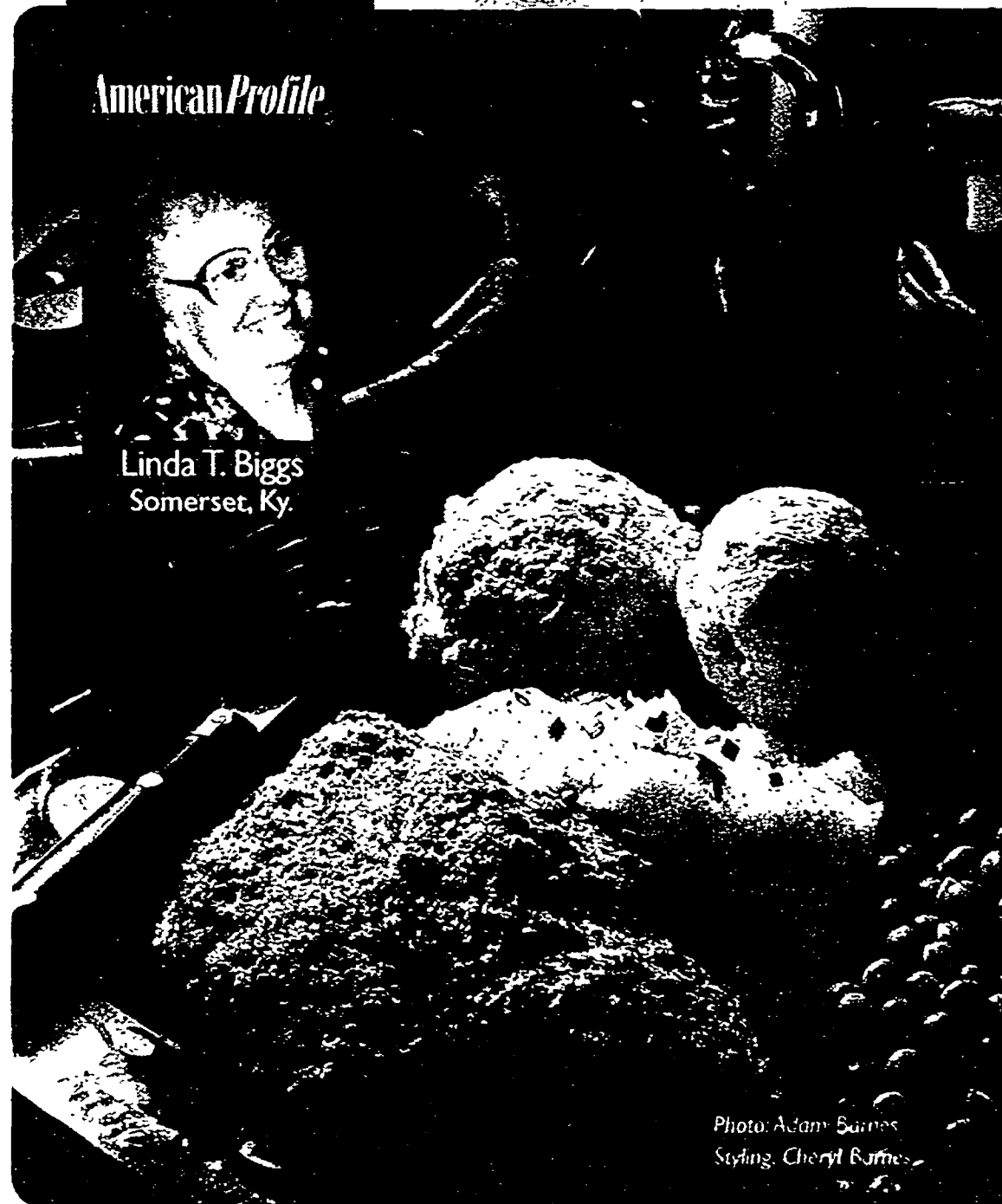

Photo: Adam Barnes  
Styling: Cheryl Barnes

## Oven-Fried Chicken

4 boneless, skinless chicken breasts  
1/3 cup mayonnaise  
1/2 cup seasoned dry bread-crumbs

Preheat oven to 350 degrees. Brush chicken evenly with a thin coating of mayonnaise on both sides. Coat chicken with breadcrumbs. Place in a shallow roasting pan. Bake for 30 to 40 minutes, until fork tender. Serves 4.

### Tips From Our Test Kitchen:

If you like spicier chicken, add 1/2 teaspoon cayenne pepper, 1 teaspoon black pepper and 2 cloves minced garlic to the breadcrumb mixture. For an Italian version, substitute olive oil for the mayonnaise and add 2 cloves minced garlic, 1 teaspoon dried oregano, 1 teaspoon dried basil and 1/3 cup grated Parmesan cheese to the breadcrumb mixture.

## Happenings

DEC. 6-25

# HOME COMING

Premieres Dec 4th, 9/8c : President Jimmy Carter & Willie Nelson in Plains, GA.

# CMT

### ILLINOIS

Dickens' Christmas in The Village—Greenup, Dec. 11. Relish the aroma of roasting chestnuts and the strains of Christmas carols during this celebration in the downtown business district. (217) 923-3401.

### INDIANA

Christmas in Historic Centerville—Centerville, Dec. 11. Get in a holiday mood by watching a lighted parade, listening to carolers and taking carriage rides while your children visit with Santa Claus. (765) 855-5333.

### IOWA

Holiday Open House—Muscatine, Dec. 10. Enjoy a performance by the local choir, refreshments and live music. (319) 262-1111.

### KANSAS

Country School Christmas—Edgerton, Dec. 11. Experience Christmas at the Lanesfield School, a one-room structure restored to its 1904 appearance, and try your hand at making ornaments. (913) 893-6645.

### MICHIGAN

Dutch WinterFest—Holland, through Dec. 11. Features a visit from Sinterklaas (the Dutch St. Nicholas), a *Kerstmarkt* (open-air Christmas market), lantern parade and ice-sculpting competition. (800) 506-1299.

### MINNESOTA

*Nun-crackers*—Red Wing, Dec. 9-12. The Sheldon Theatre presents this comical tale of nuns who tape a TV special featuring the songs *Just a Day in the Life* and *We'll Be Here*.

### MISSOURI

Christmas House Tour—Cuba, Dec. 5. Tour the Crawford County Historical Society and six homes in the Cuba area, each decorated with a unique holiday theme. For ticket information, call (877) 212-8429.

### NEBRASKA

Old-Fashioned Danish Christmas—Dannebrog, Dec. 11. Sample *aebleskiver* (Danish pancakes), and enjoy decorations throughout town, buggy rides, ethnic dancing and a Nativity pageant. (308) 226-2237.

### NORTH DAKOTA

Christmas at the Confluence—Williston, Dec. 11. Help decorate the Christmas tree at the Missouri-Yellowstone Confluence Interpretive Center and learn about the area's history. (701) 837-1111.

### OHIO

Winter Solstice Overnight—Dayton, Dec. 17-18. Spend the night at the Sun Watch Indian Village/Archaeological Park, and take a twilight tour of the grounds. For reservations, call (937) 268-8199.

### SOUTH DAKOTA

Frontier Christmas—Lake City, Dec. 11-12. Learn how Christmas was celebrated at a late 19th-century fort, and enjoy seasonal music, homemade bread and sleigh rides. Fort Sisseton Historic State Park. (605) 448-5474.

### WISCONSIN

Swiss Christmas Celebration—Eagle, Dec. 4-5 and 11-12. Enjoy the sounds of the St. Peter's Church pump organ and a Swiss dinner at Old World Wisconsin, historical museum. For reservations, call (262) 591-2922.



## Hometown Spotlight

by CANDI  
HELSETH  
*Photos by Scott  
Christiansen*

# Name That Town

What's in a name? A lot, apparently. At least that's what a North Dakota town discovered when it adopted the unlikely name of McGillicuddy City a few years ago.

When residents of Granville (pop. 286) decided to name the town after a brand of beverages in 1998, they did it only to get money enough to build a community center. But the decision has proven far more rewarding than townspeople anticipated.

"It put us on the map," says Allen Gorvaslee, a local farmer and member of the Granville Area Economic Development Corp. "Suddenly we were national and international news. It brought new people into town and generated a lot of excitement. It's revived our town."

Community leaders were looking for ways to strengthen Granville's economy and foster new business when Wendy Rollman, a volunteer grant writer who lived in Granville at the time, stumbled across a contest sponsored by Sazerac Corp., a New Orleans-based distributor of Dr. McGillicuddy's schnapps and root beer.

Sazerac was looking for a sparsely populated town typically blanketed in snow six months a year—because schnapps is preferred in cold,

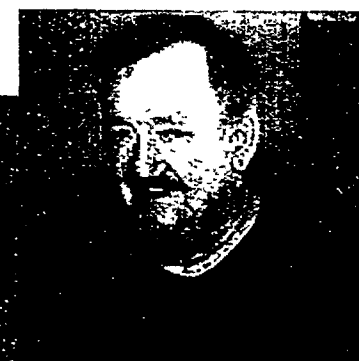

Former Mayor  
Hilman Ulland

WELCOME TO  
GRANVILLE

McGillicuddy, Oia

U.S.A.

snowy climates, according to Sazerac—willing to temporarily rename itself after the fictional Dr. Aloysius Percival McGillicuddy, the made-up inventor of two varieties of schnapps and a root beer. In return, the winning town would receive \$100,000 in \$25,000 installments over the four years it kept its adopted name.

Rules also required towns entering the contest to have lodging accommodations and a bar willing to change its name to Shady Eye Saloon, the reputed name of Dr. McGillicuddy's favorite haunt.

Granville qualified when Lucille Loftesnes, who had toyed with the idea of opening a bed and breakfast at her farm south of town, decided the time was right—and owners of the Branding Iron Saloon on Main Street adopted the required name and began serving McGillicuddy products.

"We hadn't even heard of McGillicuddy schnapps until we brought it into town," Gotvaslee recalls. At the time, the only place the brand was sold in North Dakota was in Fargo, 280 miles away.

When Granville won the contest, the community embraced the name change. "A lot of good things have happened," says former

*(Continued on page 18)*



# Wrangler FIVE STAR

Stronger Denim. More Comfortable.

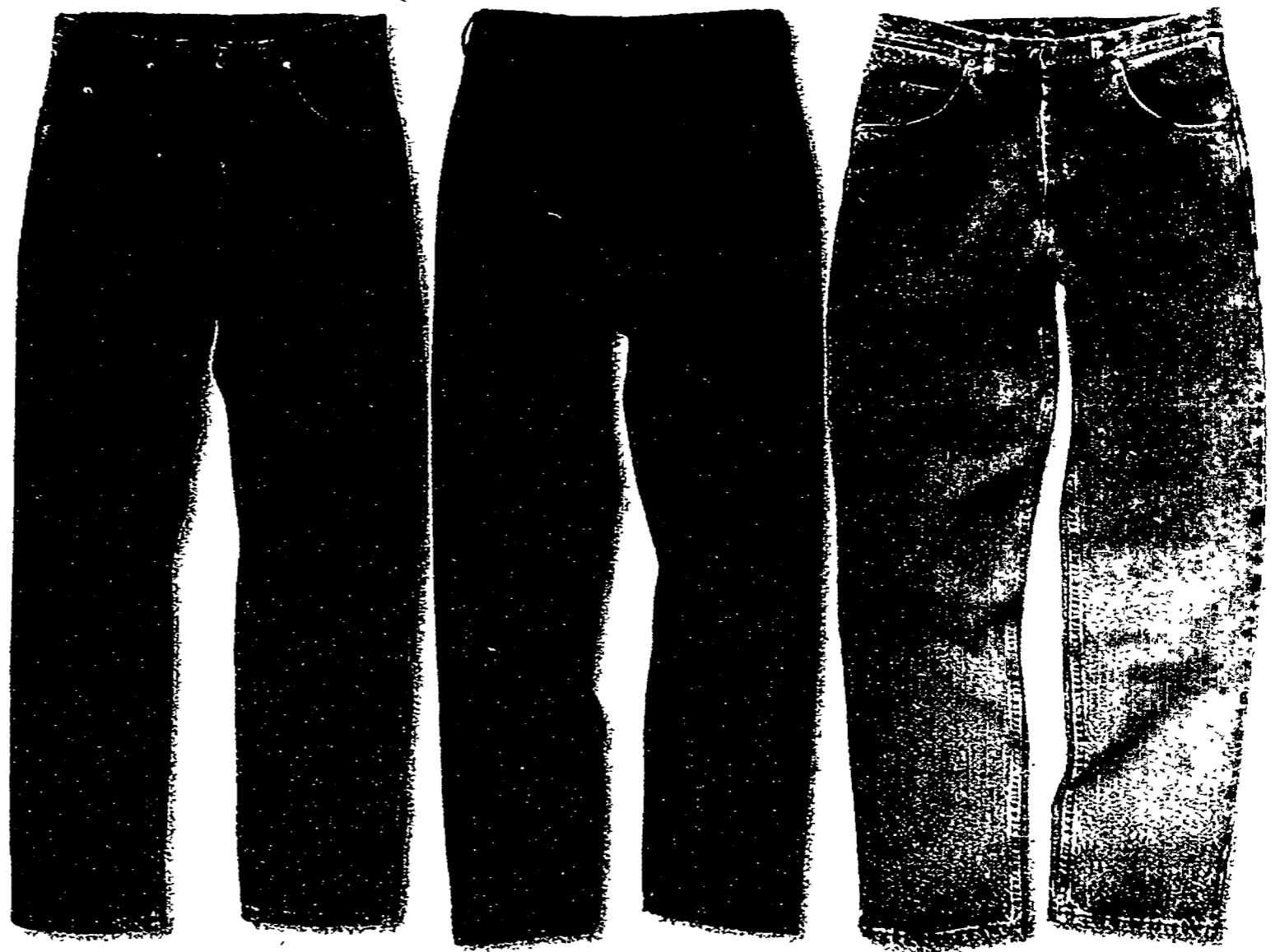

RELAXED FIT  
*Premium Quality*  
DENIM

Wrangler

For a retailer near you, call toll-free 1-888-784-8571 or visit [www.wrangler.com](http://www.wrangler.com).

Real. Comfortable. Jeans.

Get a great deal on a great lamp... Call Now

# A floor lamp that spreads sunshine all over a room and pays for itself!



**CALL TODAY  
AND RECEIVE  
FREE SHIPPING†**

*The Balanced Spectrum® floor lamp combines the benefits of natural daylight indoors with a savings of \$51 over the life of one bulb!\**

Ever since the first human went into a dark cave and built a fire, people have realized the importance of proper indoor lighting. Unfortunately, since Edison invented the light bulb, lighting technology has remained relatively prehistoric. Modern light fixtures do little to combat many symptoms of improper lighting, such as eyestrain, dryness or burning. As more and more of us spend longer hours in front of a computer monitor, the results are compounded. And the effects of indoor lighting are not necessarily limited to physical well being. Many people believe that the quantity and quality of light can play a part in one's mood and work performance. Now, there's a better way to bring the positive benefits of natural sunlight indoors.

The Balanced Spectrum® floor lamp will change the way you see and feel about your living or work spaces. Studies show that sunshine can lift your mood and your energy levels, but as we all know the sun, unfortunately, does not always shine. So to bring the benefits of natural daylight indoors, use the floor lamp that simulates the full spectrum of daylight. You will see with more clarity and enjoyment as this lamp provides sharp visibility for close tasks and reduces eyestrain.

Its 27-watt compact bulb is the equivalent to a 150-watt ordinary light bulb. This makes it perfect for activities such as reading, writing, sewing, needlepoint, and especially for aging eyes.

We've looked at lots of lights, but this one offered the benefit of dual light levels of 27 and 18 watts of power equivalent to 150 and 100-watt incandescent bulbs. This lamp has a flexible gooseneck design for maximum efficiency, with an "Instant On" switch that is flicker-free. The high-tech electronics, user-friendly design, and bulb that lasts ten times longer than an ordinary bulb make this product a must-have.

## SAVE \$51 over the life of one Balanced Spectrum® bulb!\*

A 150 watt incandescent bulb uses \$0.013 per hour in energy cost. The Balanced Spectrum® bulb uses an average of **70% less energy** which saves you \$0.009 per hour. Based on 5,000 hours bulb life, the Balanced Spectrum® bulb will save **\$46** in energy cost. Plus, because the Balanced Spectrum® bulb lasts 10 times longer than an incandescent bulb priced at an average of \$0.50, an additional **\$5** savings is realized.

\*\*Source: "Lighting the Way to Energy Savings"; 1999

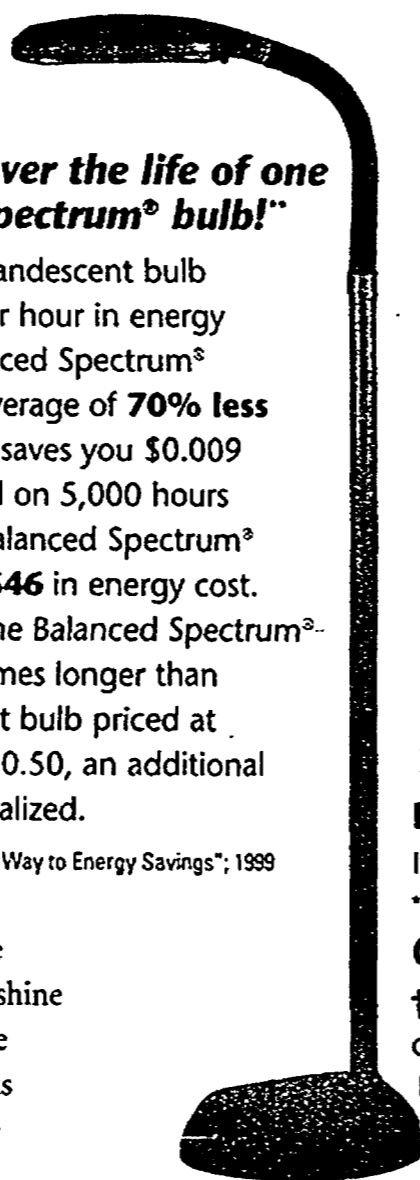

Height as shown: 50"

*"I sit in my comfortable chair after my husband has gone to bed, and I turn that lamp on. It makes it so nice because it's like daylight over my chair...I don't get sore eyes like I used to."*

Grace A.  
Margate, FL

Try the Balanced Spectrum® floor lamp now at its lowest price of less than \$50! Now more than ever is the time to add sunshine to every room in your house at this fantastic low price! The Balanced Spectrum® floor lamp comes with a one-year manufacturer's limited warranty and firstSTREET's exclusive guarantee. Try this product for 90 days and return it for the product purchase price if not completely satisfied.

### Balanced Spectrum® floor lamp

Item# 7T-3589 ..... was **\$59.95**

**Save \$10** with mail-in rebate

**Only \$49.95 ea** + S&H after rebate

†FREE shipping offer when you order two

or more Balanced Spectrum® floor lamps

Free shipping within the Continental US Only.

Please mention promotional code **29027**.

Call toll-free 24 hours a day

**800-413-9273**

To order by mail, please call for details

Available for phone order only.

**firstSTREET™**  
SEE IT HERE FIRST

Formerly TechnoScout®

1998 Ruffin Mill Road • Colonial Heights, VA 23834

All rights reserved. © 2004 firstSTREET, Inc.

39555

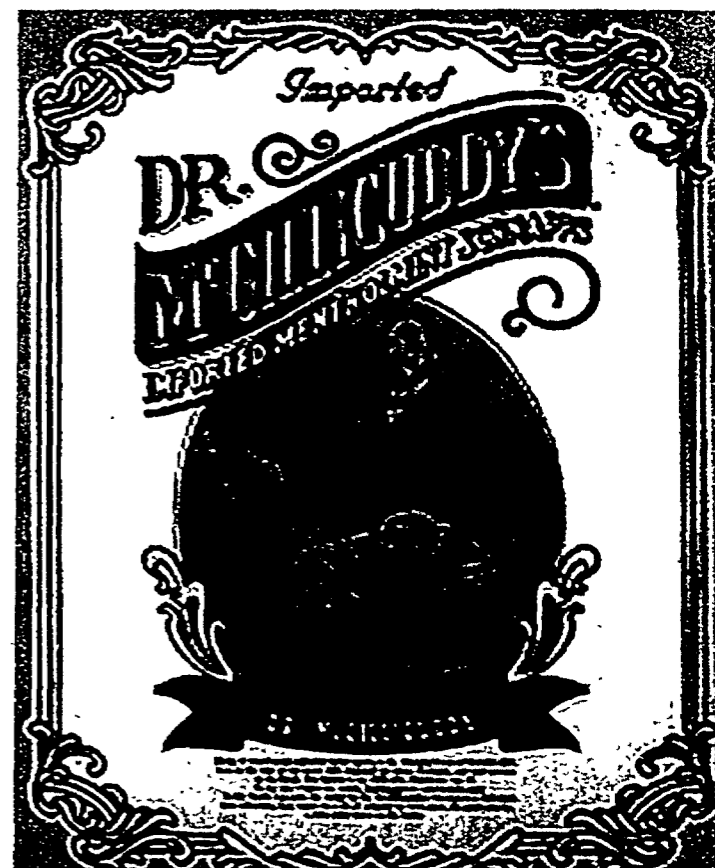

Dr. Aloysius P. McGillicuddy, the town's fictional namesake, appears in a beverage advertisement.

(Continued from page 17)

Mayor Hilman Ulland. "We put in a rodeo grounds, RV hookups and two new buildings in the park. Some of the town's organizations raised money for those things. The name change got us going."

"Everyone got into the spirit, and we've really had fun with it," adds Cora Mae Shipman, a lifelong Granville resident who has created recipes for home-baked goods flavored with McGillicuddy schnapps.

The name change also spurred an annual celebration known as McGillicuddy Days. The July celebration features a parade, live entertainment, church service and a team roping competition.

"I think the most interesting part of all of this is the people we've met because of it," says Loftesnes, owner of Carver Lake Lodge, whose guests have included a Baltimore, Md., couple with the last name of McGillicuddy.

The McGillicuddys, who were scouting McGillicuddy City as a possible site for a future family reunion, suggested residents retain the town name because there is only one McGillicuddy City, while the nation has a dozen Granvilles.

Many townspeople agree, and many have grown fond of the town's adopted moniker. "We like the McGillicuddy name and what it's done for us," says LaDona Malachowski, a lifelong resident. "If we can keep it, we will."

Although the contest ended years ago, the town still proudly displays its McGillicuddy City USA sign. Residents seem content to keep the sign, along with their new community center. ☆

Candi Helseth is a freelance writer in Minot, N.D.

### Rate This Story

How do you like this story? Log on to our website at [www.americanprofile.com](http://www.americanprofile.com)



# Handy Hints

## 3 Ways to Use an Old Coffee Can

### Less-mess brush cleaning

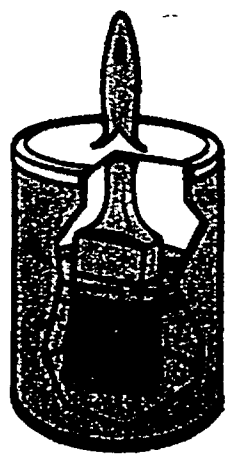

An empty coffee can with a plastic lid makes a great brush soaking container. Cut a small "X" in the center of the lid, push the handle up through the "X" and place the lid on the can. The lid seals the can so the water or solvent doesn't evaporate, and it suspends the bristles above the bottom of the can so they don't curl or gunk together.

### Neater paint stripping

Minimize the mess and speed up work when stripping paint or varnish off old furniture or moldings. Cut a thin slot in the side of an empty can and use it to run your putty knife through to remove the glop. Make the slot slightly wider than the thickness of the blade and a little deeper than its width.

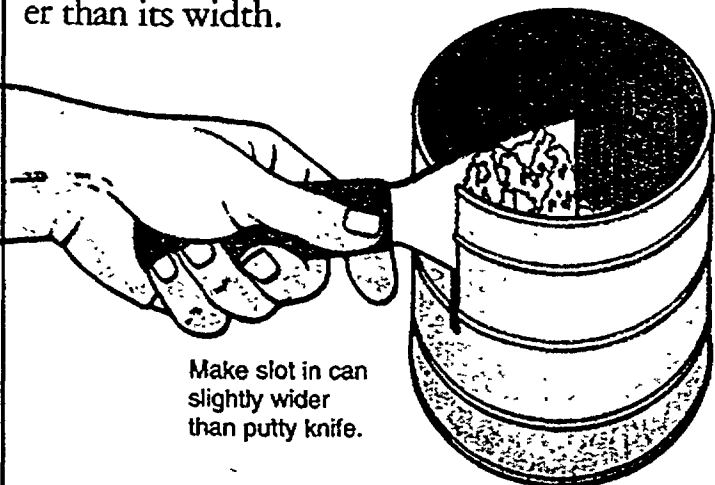

Make slot in can slightly wider than putty knife.

### All-purpose spreader



Turn a coffee can into a handy spreader for grass seed, sidewalk salt or sweeping compound. Use a short piece of metal tubing or an old paper punch to punch holes in the plastic lid. Offset the holes from row to row to ensure even spreading. ☆

Helpful hints researched and provided by:

**The Family Handyman**  
www.familyhandyman.com

# Finding Your SLEEP NUMBER® is The Key to a Perfect Night's Sleep<sup>SM</sup>

## YOU CUSTOMIZE THE FIRMNESS

The Sleep Number® bed is unlike any other. It's the bed you adjust to your exact comfort and firmness preference, your Sleep Number®. Our easy-to-use handheld remote and advanced air-chamber technology allow you to quickly adjust firmness on your side of the bed. At the simple touch of a button YOU can change the firmness from extra firm to feather soft.

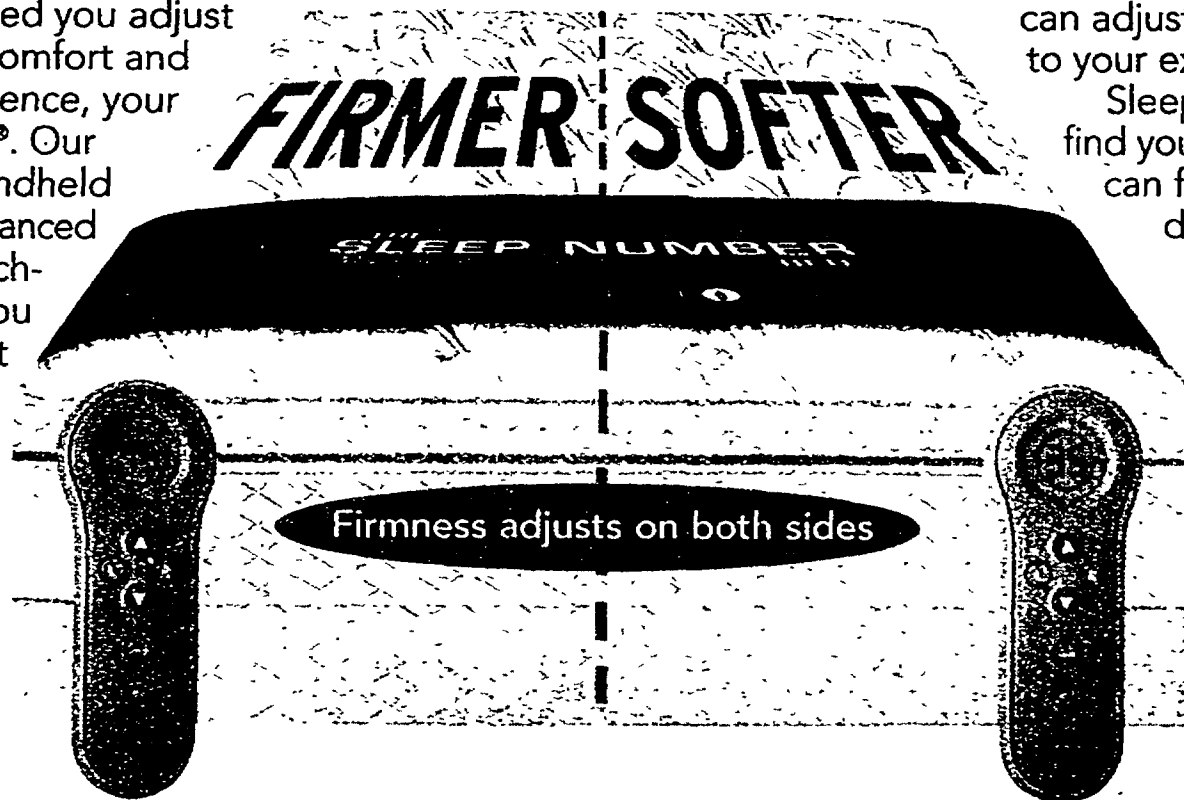

## EACH SIDE OF THE BED ADJUSTS INDEPENDENTLY

On a Sleep Number® bed, each of you can adjust comfort and firmness to your exact preference—your Sleep Number®. Once you find your Sleep Number®, you can fall asleep faster, enjoy deeper sleep and wake up more refreshed.

## GREAT VALUE

The Sleep Number® bed costs about the same as an innerspring mattress yet it lasts twice as long. And each Sleep Number® bed comes with a Risk-Free 30-Night In-Home Trial.\*\*

## Call For More Information

You owe it to yourself to learn more about this revolutionary way to improve your sleep.

For a FREE VIDEO and Brochure, call now!

**1-800-831-1211**

Ext. 29892



## CLINICALLY PROVEN

It's the bed clinically proven to relieve back-pain and improve sleep quality.\*

Clinical studies show an amazing 93% of participants reported back-pain relief while 90% said other aches and pains were reduced.\*

77%  
Discovered increased energy

67%  
Enjoyed less daytime sleepiness

89%  
Reported improved sleep quality

87%  
Fell asleep faster and experienced deeper sleep

93%  
Experienced back-pain relief

90%  
Reported reduced aches and pains

**1-800-831-1211** ext. 29892

YES! Please rush me a FREE Video and Brochure

Mr./Mrs./Ms. Name (Please print)

Address

City

State

Zip

Daytime Phone

Email

Mail to: Select Comfort 6105 Trenton Lane N., Minneapolis, MN 55442 ext. 29892

THE SLEEP NUMBER BED

select comfort

# Curing Dental Anxiety

by MARY LEBEAU

According to the American Dental Association and the American Academy of Pediatric Dentistry, children should see a dentist within six months of cutting their first tooth. Unfortunately, the thought of a dentist visit may cause anxiety in parent and child alike.

Finding the right dentist is key to making a dental visit a positive experience. Many dental professionals enjoy catering to the littlest patients. Don't hesitate to shop around. Ask for references from referral specialists, friends and other children. Visit offices beforehand, talk to the staff, and check out the surroundings. As the child's parent, you know where your child would feel comfortable.

Other tips:

**Keep it to yourself**—A child isn't born with "dental anxiety." Usually it's inherited—from his parent. Even if you've had bad experiences, keep your discussions about the dentist positive.

**It's no big deal**—Would you tell your child, "We're going to the grocery



store. Don't worry, it won't hurt? Of course not! Use the same "no big deal" language when talking about the dentist. Never refer to "hurt" or "pain."

**Talk about it**—Discuss the visit with the child, giving him an opportunity to voice his fears. (This also gives you the chance to address them, honestly, but in a matter-of-fact manner.)

**The play's the thing**—Some toys and books allow the child an "insider's look at the dentist." Toys such as Play-Doh's Dr. Drill and Fill, or books like *The Berenstain Bears Visit the Dentist*, can be reassuring.

**Try it out**—Before the visit, use props to let your children "play" dentist. They can check the family's teeth or the teeth of a stuffed animal. Make sure your child has a chance practicing being a patient, too.  
**Pre-visit**—Many dentists allow a "fun visit," when the child can check out the office. A ride in the chair, a look in the mirror and a free toothbrush later, the child's ready for the next, "real" visit.

**Timing is everything**—Schedule the appointment to work with your child's



personality. If he wakes up happy, an early appointment is best. A cranky riser? Visit after lunch.

**Hear and now**—If the sound of the drill causes anxiety, ask the dentist if you can bring headphones so your child's favorite music can drown it out.

**Familiar faces**—Many children feel better if a parent or sibling is present during the exam. Some dentists even allow younger children to sit on mom's lap during routine work.

It's natural to be anxious when facing a new experience. But if you follow these tips, your child can face his fears with a happy—and healthy—smile. ☆

Mary Lebeau is a writer in Woodbury, N.J.

ADVERTISEMENT

## Arthritis Pain and Fibromyalgia Linked to Bowel Health

By Dr. Ron Gellatley

**D**id you know that arthritis and fibromyalgia can be linked to a waste-clogged bowel? In fact, you'll be astonished to learn that a lot of diseases that seem to have little to do with your bowel are actually associated with a bowel suffocating with undischarged wastes. These wastes can slowly poison your system and contribute to a variety of health problems.

**Do you suffer from any of these complaints?**

In addition, stomach problems, headaches, backaches, candida, low motivation, lack of energy and low immunity have been associated to bowel problems.

The trouble is that few people realize their bowel is clogged.

We think our problems have other causes. We do not understand that these wastes are affecting every cell and every tissue in our body. We cannot understand why we are tired all the time or why we have difficulty with moodiness and cannot cope. All too often our problems come from our bowel.

My new book, "Internal Health" (already a best seller in Australia) is packed with vital information:

- You will find natural ways to rid yourself of constipation.
- You will find simple ways to bear irritable bowel.
- Discover the supplements that help diverticulitis.
- Why put up with bloating and indigestion if you don't have to?
- Most people who are constipated take fiber. Find out why some fibers can make your condition worse, not better.
- Antibiotics seem to be given out for almost everything and you should find out what they can do to you.
- Why do children who take a lot of antibiotics seem to catch everything that is going around?
- Find out what we all must do after taking antibiotics. The book explains why eating yogurt will not do for you what you think it is doing.

You can find all this information and much more in this fascinating book.

If you want to feel better, if you want to have more energy, then this book is for you. I have discovered in over 15 years of practice that the major cause of loss of energy and various health problems is an internal system that is

not working properly.

If you suffer with diverticulitis, constipation, irritable bowel and bloating and are concerned about other complaints associated with bowel problems, this book is a must read! You learn step-by-step how to supercharge your entire digestive system...and you can feel better than you have in years.

This amazing book is already a best seller in Australia having sold for \$32.95 each. Right now as part of a special U.S. edition introductory offer, you can order a special press run of "Internal Health" for only \$12.95 plus \$2.00 shipping. It comes with a 90 day money back guarantee. If you are not 100% satisfied, simply return it for a full refund - no questions asked.

Order an extra copy for family or friend and SAVE. You can order 2 for only \$20 total.

**HERE'S HOW TO ORDER:** Simply PRINT your name and address and the words "Internal Health" on a piece of paper and mail it along with a check or money order to: THE LEADER CO., INC., Publishing Division, Dept. IH807, P.O. Box 8347, Canton, OH 44711. VISA or MasterCard send card number and expiration date. Act now. Orders will be fulfilled on a first come, first served basis.

FREE  
Shipping & Handling



Enlarged to  
show detail.  
Actual size: 1 1/4",  
including crystal

LENOX

*Gifts That Celebrate Life*

# The "TWEETY" Heart Pendant

THE FIRST LOONEY TUNES  
PENDANT FROM LENOX

STERLING SILVER AND  
24 KARAT GOLD ELECTROPLATE

He's cute, bright yellow, and oh so innocent. He's Tweety—the world's most lovable canary featured in 45 Looney Tunes animated shorts. And now, he's at the heart of a dazzling Lenox pendant inspired by original Looney Tunes animation art.

In *The Tweety Heart Pendant*, the world-famous Tweety of the silver screen is perched in a sterling silver heart. A sparkling crystal is set above the heart. And Tweety glows in pure 24 karat gold

electroplate, wearing the wide-eyed expression that has made him a star.

*The Tweety Heart Pendant* is the first Looney Tunes jewelry ever designed by Lenox.

The price is just \$76, payable in monthly installments. This imported Lenox® pendant will bear the Warner Bros. hallmark. A Certificate of Authenticity and 20" sterling silver chain will accompany the pendant.

To acquire this "tweeheart" of a pendant, complete and mail the Order Form today.

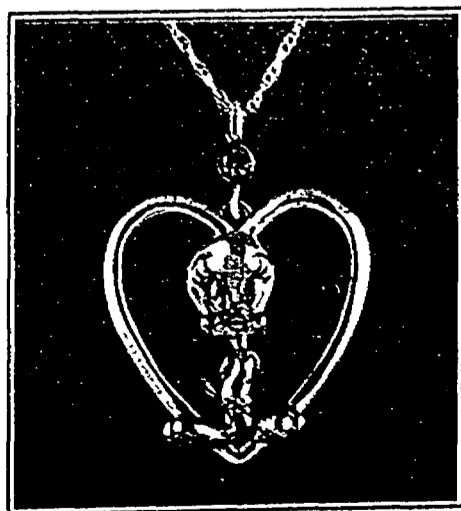

Pendant shown actual size  
of 1 1/4" high, including crystal.  
20" sterling silver chain included.

### Order Form • Mail within 30 days

I wish to acquire *The Tweety Heart Pendant*, an original Lenox pendant to be crafted for me of sterling silver and 24 karat gold electroplate and set with a brilliant gem-cut crystal.

I need send no money now. I will be billed for my pendant in four monthly installments of \$19\* each. *My satisfaction is guaranteed.*



Signature \_\_\_\_\_

ALL ORDERS ARE SUBJECT TO ACCEPTANCE

Name \_\_\_\_\_

PLEASE PRINT CLEARLY

Address \_\_\_\_\_

City \_\_\_\_\_ State \_\_\_\_\_ Zip \_\_\_\_\_

3617859

Telephone (\_\_\_\_\_) \_\_\_\_\_

E-mail \_\_\_\_\_

\* Free shipping, handling, and insurance. Your sales tax will be added.

Mail to: Lenox Collections

P.O. Box 3020 • Langhorne, PA 19047-9120

LOONEY TUNES, characters, names and all related indicia are trademarks of and © Warner Bros. (s04)

© LENOX, Inc. 2004  
LOONEY TUNES, characters, names and all related indicia are trademarks of and © Warner Bros. (s04)  
For more information on Looney Tunes, please visit [www.looneytunes.com](http://www.looneytunes.com)

Visit us at: [www.Lenox.com](http://www.Lenox.com)



Name: \_\_\_\_\_  
 Address: \_\_\_\_\_  
 City: \_\_\_\_\_  
 State/Zip: \_\_\_\_\_  
 Phone: \_\_\_\_\_

## Profiles in History

# Ben Franklin Lasting Legacy

Although Founding Father Ben Franklin died more than 200 years ago, the scientist, diplomat and writer remains a hot topic to this day. Walter Isaacson's biography, *Benjamin Franklin: An American Life*, is a national best seller, while author Stephen Covey studied Franklin's foundation of success to write his popular book, *The 7 Habits of Highly Effective People*.

At 9 p.m. ET Dec. 5, The History Channel unveils a two-hour documentary, *Ben Franklin*, which examines the life of the brilliant yet elusive man who helped edit the *Declaration of Independence* and was the driving force behind the first public lending library and the first non-religious college.

Isaacson, the former chairman of CNN and the current president of the Aspen Institute, a non-profit organization that fosters leadership, discusses Franklin's ongoing appeal:

**AP: Why is Franklin so popular now?**

**WI:** Because America has lost touch with Main Street values, shopkeeper values, and that's what Franklin represented. He represented the ability to show simple virtues like honesty and hard work, and being tolerant of other people and taking care of your community. That is what Franklin was all about, taking care of your community, working together and forming associations. And in America, we now sometimes worry that we're divided or torn apart and he was about bringing people together in clubs and do-good societies and libraries and volunteer fire departments. Secondly, he was not very ideological. He was a pragmatic politician who wanted to see what worked and find effective compromise around policies. He is sort of in con-



Walter Isaacson

by BEVERLY KEEL  
*Entertainment Editor*

trast to the very partisan and bickering politicians we have today.

**AP: You've said he's the Founding Father people can relate to. Why?**

**WI:** He is made of flesh and blood, not carved in marble on a pedestal. He had his own flaws—he was not a great husband—but he loved his family and loved his country. He was not too pretentious and didn't try to be an aristocrat, like some of the others. He was very much a believer in the middle class. He wrote his autobiography to try to convince his son, who was putting on a lot of airs, to remember his humble roots and to be proud of coming from a long line of shopkeepers.

**AP: Franklin has been described as the one Founding Father easiest to imagine living in the 21st century. If he were alive today, what would he be like?**

**WI:** He would be the type of person who would love technology and love free choice and free competition and free markets and free minds and a free press. He was a great believer in freedom. He thought the average person should be trusted to make his or her own choices. He was the type of person you would want to show your new cell phone to, or discuss foreign policy with or tell the latest joke about a priest and a rabbi.

**AP: What would the patron saint of self-improvement guides think of our culture?**

**WI:** He would not be snobby about Oprah Winfrey or Dr. Phil. He thought an earnest but also a humorous approach to self-improvement was a great thing. He used to make a list of all the virtues he wanted to acquire. *Poor Richard's Almanack* is the first self-help book, and he wrote it to help young tradesmen in Philadelphia become better citizens.

**AP: In America (The Book), Jon Stewart jokes that if Thomas Jefferson were alive today, he would like actress Halle Berry. Which celebrity would Franklin like?**

**WI:** He would've liked Jon Stewart because Jon Stewart is non-ideological but he has a sense of humor that rivals the one Franklin showed in *Poor Richard's Almanack*. Jon Stewart is the direct descendant of Ben Franklin's sense of political humor.

**TO LEARN MORE...  
 Watch Ben  
 Franklin, which airs  
 on The History  
 Channel at 9 p.m.  
 ET Dec. 5.**

**AP: Who today most embodies Franklin's talents or spirit?**

**WI:** Franklin was the best diplomat of his age, the best scientist, the best writer, the best inventor, the most practical politician and the great civic leader. Nobody today can come close to doing all of that. ✨

### Rate This Story

How did you like this story? Log on to [www.americanprofile.com/rate](http://www.americanprofile.com/rate)



WIN A TRIP TO THE 2005  
 WRANGLER NATIONAL  
 FINALS RODEO!

Enter the

*American Profile*

Wrangler National  
 Finals Rodeo

Sweepstakes  
 Sponsored by Dodge

**AmericanProfile** will fly one lucky reader and a guest to **Las Vegas** on Monday, December 5, 2005 where they will spend three nights at **The Sam's Town Hotel and Gambling Hall**. Two of the nights of their wonderful stay at **Sam's Town**, they will be taken to the Thomas & Mack Center, where they will see the greatest cowboys in the world compete in the **Wrangler National Finals Rodeo**, courtesy of **Sam's Town** and the **PRCA**.  
 Sponsored by Dodge.

GRAB LIFE BY THE HORNS



DODGE

[www.dodge.com](http://www.dodge.com)



PRCA  
 PRORODEO.

SAM'S  
 TOWN

NO PURCHASE NECESSARY TO ENTER OR WIN. All prizes will be awarded. Open to legal residents of the continental United States, 21 years of age or older. Void where prohibited or restricted by law. How to enter: (1) Visit [www.americanprofile.com](http://www.americanprofile.com) and follow the instructions or (2) print your name, address, and phone number on a 3" x 5" piece of paper and send it to: American Profile Wrangler National Finals Rodeo Sweepstakes, American Profile, 341 Cool Springs Blvd., Suite 400, Franklin, TN 37067 ("Sponsor's Address"). Official Sweepstakes Rules available at [www.americanprofile.com](http://www.americanprofile.com) or by writing to Sponsor's Address, Attn: RTA Sweepstakes Official Rules. Sweepstakes governed by and subject to Official Sweepstakes Rules. Entries must be postmarked by February 28, 2005. Trip must be taken on December 5-8, 2005.

GET A

4-ROOM

DIRECTV® SYSTEM



FREE

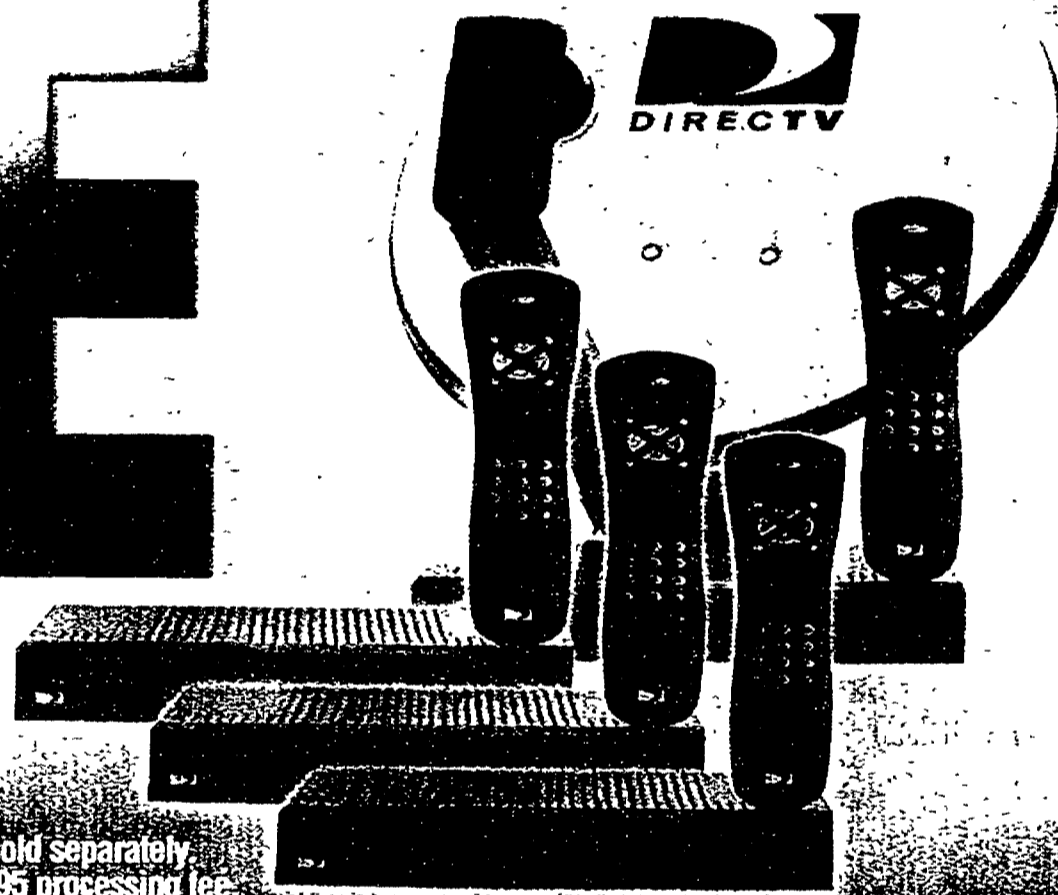

INCLUDES STANDARD DIRECTV® SYSTEM WITH 4 RECEIVERS, 4 REMOTES, 1 DISH AND STANDARD INSTALLATION

Offer ends February 28, 2005. New customers only. Hardware and programming sold separately. Add \$4.99/mo. for separate programming on second and each additional TV. \$19.95 processing fee.

PLUS, ORDER TODAY AND GET A \$40 WAL-MART® GIFT CARD FREE!

DIRECT\*STARTV

An Authorized DIRECTV® Retailer

Reloadable Shopping Card

WAL\*MART Walmart.com



PLUS!

Get 3 months of...

HBO®

& cinemax FREE!

When you subscribe to HBO® & CINEMAX® with your annual subscription to any TOTAL CHOICE® programming package

1-800-520-6605

Se Habla Español

Major Credit Card Required

Walmart® gift card is provided by DirectStarTV and is not sponsored by DIRECTV. Limit one Walmart® gift card and free system per household. To be eligible for the Walmart® gift card, you must be a new DIRECTV customer, have ordered a DIRECTV System through DirectStarTV via this offer, and complied with our redemption instructions. Upon validation which is the sole discretion of DirectStarTV, the Walmart® gift card will be sent to your billing address. To claim the Walmart® gift card, mail in an original copy of your first paid DIRECTV monthly bill and an original copy of this offer to ADVWGC, 14120 Ballantyne Corporate Place, Suite 200, Charlotte, NC 28277. Please allow 8-12 weeks for delivery. DirectStarTV reserves the right to reject any redemption claims that are deemed fraudulent and/or not originating from DIRECTV orders placed in conjunction with this DirectStarTV promotion. Offer void in Alaska and Hawaii, and where prohibited or restricted. While supplies last. DirectStarTV is not affiliated with Wal-Mart Stores, Inc. The services, products, or activities of DirectStarTV are neither endorsed nor sponsored by Wal-Mart Stores, Inc.

In select markets DIRECTV offers local channels. Eligibility based on service address within certain designated market areas as defined by Nielsen Media Research, Inc. ACTIVATION OF PROGRAMMING MAY BE SUBJECT TO CREDIT APPROVAL AND REQUIRES VALID SERVICE ADDRESS, SOCIAL SECURITY NUMBER AND/OR MAJOR CREDIT CARD. DEPOSIT OR PREPAYMENT MAY BE REQUIRED. In some areas, programming may be provided by members or affiliates of the National Rural Telecommunications Cooperative. In these areas, programming and pricing may differ from that described herein. Limited-time offer for new residential customers who purchase any DIRECTV System from DirectStarTV by 2/28/05 and subscribe to 12 consecutive months of any DIRECTV TOTAL CHOICE programming package (\$36.99/mo. or above) or DIRECTV PARA TODOS programming package (\$33.99/mo. or above); within 30 days of equipment purchase. IF YOU FAIL TO ACTIVATE THE DIRECTV SYSTEM WITHIN 30 DAYS OF PURCHASE, YOU AGREE THAT DIRECTV MAY CHARGE A FEE OF \$150.00, AS LIQUIDATED DAMAGES, PER DIRECTV RECEIVER NOT ACTIVATED. IF YOU FAIL TO MAINTAIN AND PAY FOR TWELVE (12) CONSECUTIVE MONTHS OF THE REQUIRED PROGRAMMING PACKAGE, YOU AGREE THAT DIRECTV MAY CHARGE YOU A PRORATED FEE OF UP TO ONE HUNDRED FIFTY U.S. DOLLARS (\$150.00); WITHIN 14 DAYS OF DOWNGRADING OR DISCONNECTING YOUR PROGRAMMING, YOU HAVE AN OPTION TO SEND ALL OF YOUR DIRECTV SYSTEM EQUIPMENT (RECEIVER(S) AND REMOTE CONTROL(S)) TO DIRECTV IN LIEU OF PAYMENT. THE EQUIPMENT, INCLUDING THE ACCESS CARD INSERTED INTO EACH DIRECTV SYSTEM RECEIVER UNIT, MUST BE RETURNED TO DIRECTV IN GOOD WORKING ORDER, NORMAL WEAR AND TEAR EXCEPTED. SEE DIRECTV.COM OR CALL 1-800-DIRECTV FOR DETAILS. FEE FOR SEPARATE PROGRAMMING ON SECOND AND EACH ADDITIONAL TV \$4.99/MO. IF ALL RECEIVERS CONTINUOUSLY CONNECTED TO THE SAME LAND-BASED PHONE LINE. Programming, pricing, terms and conditions subject to change. Pricing is residential. Taxes not included. Equipment specifications and programming options may vary in Alaska and Hawaii. DIRECTV services not provided outside the U.S. Receipt of DIRECTV programming is subject to the terms of the DIRECTV Customer Agreement; a copy is provided at DIRECTV.com and in your first bill. ©2004 DIRECTV, Inc. DIRECTV and the Cyclone Design logo, TOTAL CHOICE and DIRECTV PARA TODOS are registered trademarks of DIRECTV, Inc. All other trademarks and service marks are the property of their respective owners. Order Code: AMP1104



# **Ben Franklin. Inventor. Patriot. Playboy.**

Early to bed and early to rise? You don't know Ben.  
Meet the Founding Father with star power to spare.  
**Ben Franklin. Catch the Lightning.**

**Sunday  
December 5th 9pm/8c**



**THE  
HISTORY  
CHANNEL.**

History.com